



we take a closer look

+ General Surgery



we take a *closer look*





we take a closer look

WE



B

The face of health care industry is changing and we are helping you to face the challenges of this change. Ehsan Surgical Company aim to introduce high quality Surgical, Dental and Orthodontics instruments in the world market, as to continue at its best a renovating process with a broad spectrum in order to innovate for surgeons through latest technology. A small but professional company we are constantly looking for areas of growth and continual improvement. Our philosophy is investment in technology, equipment and training of staff enabling them to achieve consistent standards of service and quality according to the customer's expectation. We are committed to satisfy our customers by carrying out systematic activities effectively and efficiently, providing them high quality products at appropriate time and competitive price.

RN



we take a closer look

Estd. 1995

OUR QUALITY All Surgical Instruments are made from high quality stainless steel will pass three crucial checks that verify the durability, toughness and good machining. In addition, a monitoring specialist for the last time the instruments directly before shipping. All Surgical Instruments are manufactured by medical grade stainless steel and can be sterilized by all common methods (either chemical or thermodynamic).



OUR GOAL is to provide quality surgical, dental and orthodontics products at Affordable prices. Our best Operating Room quality instruments incorporating the highest grades of surgical steel, finely detailed craftsmanship and exacting standards of manufacturing.





TABLE⁺ OF CONTENT

02

SCALPELS

- » Scalpel Handles and lades
- » Skalpellklingen und Skalpellgriffe
- » Lames et manches de bistouris
- » Hojas y mangos de bisturí
- » Lame e manici per bisturi

13

SCISSORS

- » Micro Scissors
- » Surgical Scissors
- » Ligature Scissors
- » Wire & Plate

81

TISSUE | DRESSING FORCEPS

- » Chirurgische und Anatomische Pinzetten
- » Pinces à tissus et à pansement
- » Pinzas quirúrgicas y anatómicas
- » Pinzette chirurgiche e anatomiche

111

HEMOSTATIC FORCEPS TOWEL CLAMPS

- » Arterienklemmen | Tuchklemmen
- » Pinces hémostatiques | Pinces à champs
- » Pinzas hemostáticas | Pinzas de campo
- » Pinzette emostatiche | Fissateli

142

ATRAUMATIC VASCULAR CLAMPS

- » Atraumatische Gefäßklemmen
- » Pinces vasculaires atraumatiques
- » Pinzas vasculares atraumáticas
- » Pinze vascolari atraumatiche

202

NEEDLE HOLDERS

- » Needle Holders
- » Ligature Needles
- » Nadelhalter
- » Unterbindngsnadeln
- » Porte-aiguilles
- » Aiguilles à ligatures
- » Porta-agujas
- » Agujas para ligaduras
- » Port'aghi
- » Aghi per legature

242

PROBES | COTTON APPLICATOR

- » Sonden | Watteträger
- » Sondes | Applicateur de coton
- » Sondas | Porta-algodón
- » Sonde | Portacotone

248

RETRACTORS

- » Retraktoren
- » Écarteurs
- » Separadores
- » Divaricatori

336

TROCAR BIOPSY NEEDLES

- » Trokar | Biopsienadeln
- » Trocart | Aiguilles pour biopsie
- » Trocar | Aguja para biopsia
- » Trocar | Aghi da biopsia

343

ELEVATORS, PERIOSTEAL, BONE FILES, CURETTES

- » Elevatoren | Raspatorien
Knochenfeilen | Küretten
- » Élévateurs
Rugines périostiques
Limes à os | Curettes
- » Elevadores | Periostótomos
Limas para hueso | Curetas
- » Elevatori | Scollaperiosteo
Lime per osso | Curettes

390

MALLET, OSTEOTOME , BONE CHISE

- » Hämmer | Osteotom
Knochenmeißel
- » Maillet | Ostéotome
Burin à os
- » Martillo | Osteotomo
Cinzel para hueso
- » Martello | Osteotomo
Scalpello per osso

413

BONE SURGERY LAMINECTOMY

- » Knochenchirurgie | Laminektomie
- » Chirurgie osseuse | Laminectomia
- » Cirugía ósea | Laminectomía
- » Chirurgia ossea | Laminectomia

495

ENT OTOLARYNGOLOGY

- » HNO - Heilkunde
- » ORL - Oto-rhino-laryngologie
- » ORL - Otorrinolaringología
- » ORL - Otorinolaringoiatria

546

OPHTHALMOLOGY

- » Ophthalmologie
- » Ophtalmologie
- » Oftalmología
- » Oftalmologia

579

GYNECOLOGY UROLOGY

- » Gynäkologie | Urologie
- » Gynécologie | Urologie
- » Ginecología | Urología
- » Ginecologia | Urologia

614

SUCTION TUBES

- » Saugkanülen
- » Canules d'aspiration
- » Cánulas de aspiración
- » Cannule per aspirazione

641

MAINTENANCE STERILIZATION

- » Wartung und Sterilisierung
- » Entretien et Stérilisation
- » Mantenimiento y Esterilización
- » Manutenzione e Sterilizzazione



we take a *closer look*



we take a closer look

Scalpel Blades and Handles



Skalpellklingen und Skalpellgriffe
Lames et manches de bistouris
Hojas y mangos de bisturí
Lame e manici per bisturi

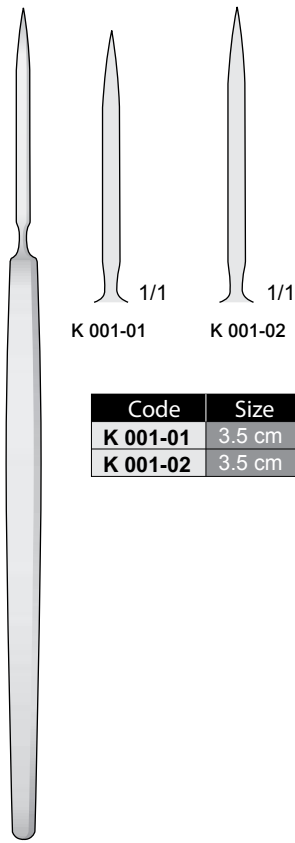

Code	Size
K 001-01	3.5 cm
K 001-02	3.5 cm

GRAEFE
K 001-14 14 cm

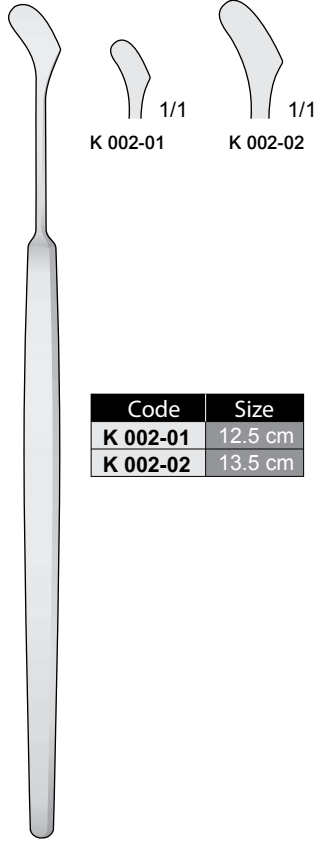

Code	Size
K 002-01	12.5 cm
K 002-02	13.5 cm

GRAEFE
K 002-14 14 cm

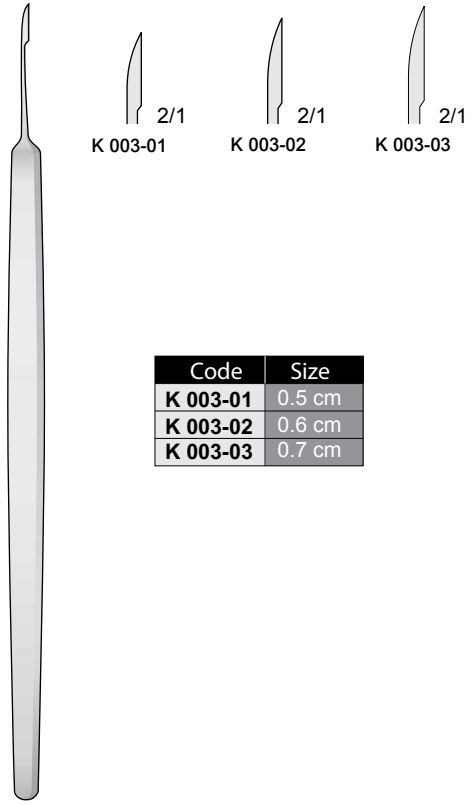

Code	Size
K 003-01	0.5 cm
K 003-02	0.6 cm
K 003-03	0.7 cm

ZIEGLER
K 003-11 11.5 cm

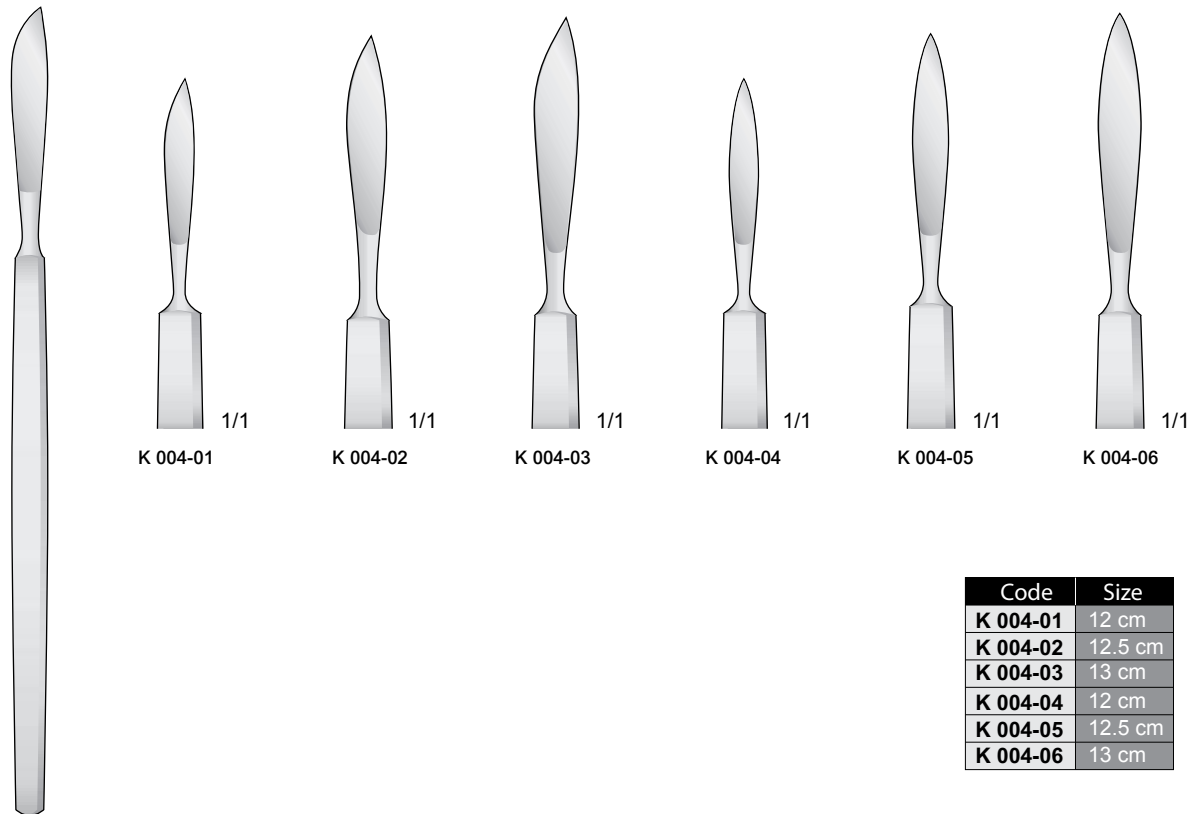

Code	Size
K 004-01	12 cm
K 004-02	12.5 cm
K 004-03	13 cm
K 004-04	12 cm
K 004-05	12.5 cm
K 004-06	13 cm

K 004-12 12 cm

Punche da biopsia - Dermal punches
Haut-Trephinen - Tréphinies cutanées
Trépanos cutâneos

Code	Size
K 005-01	0.3 cm
K 005-02	0.4 cm
K 005-03	0.5 cm
K 005-04	0.6 cm

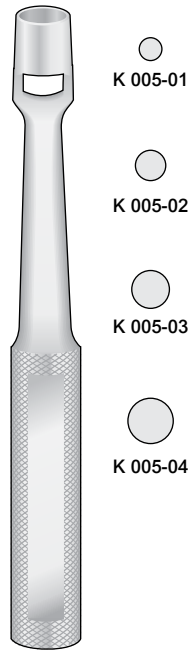

KEYES

K 005-10 10 cm

DESMARRES

K 006-13 13 cm

DESMARRES

K 007-13 13.5 cm

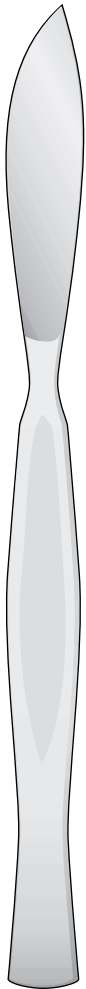

K 008-18 18 cm



K 009-28 28 cm

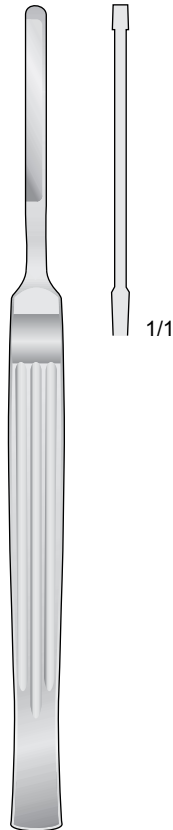

JOSEPH

K 010-15 15 cm

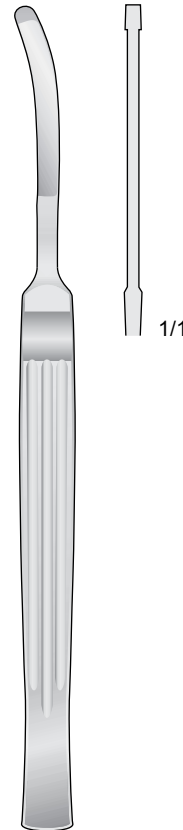

CONVERSE

K 011-16 16 cm

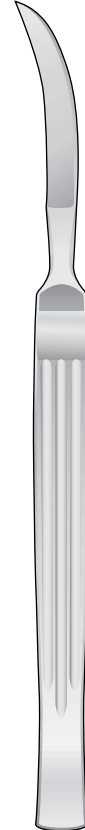

K 012-16 16 cm

Code	Size
K 013-01	15 cm
K 013-02	15.5 cm
K 013-03	15.8 cm
K 013-04	16 cm
K 013-05	17 cm
K 013-06	17.5 cm



K 013-15 15.8 cm

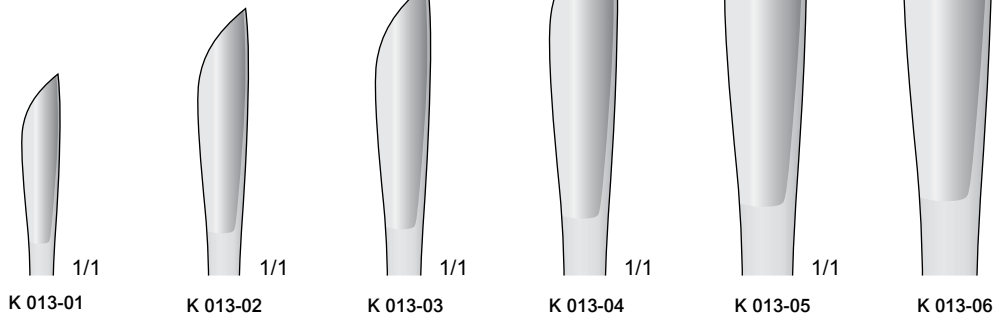

Code	Size
K 013-07	15 cm
K 013-08	15.5 cm
K 013-09	15.8 cm
K 013-10	16 cm
K 013-11	17 cm
K 013-12	17.5 cm

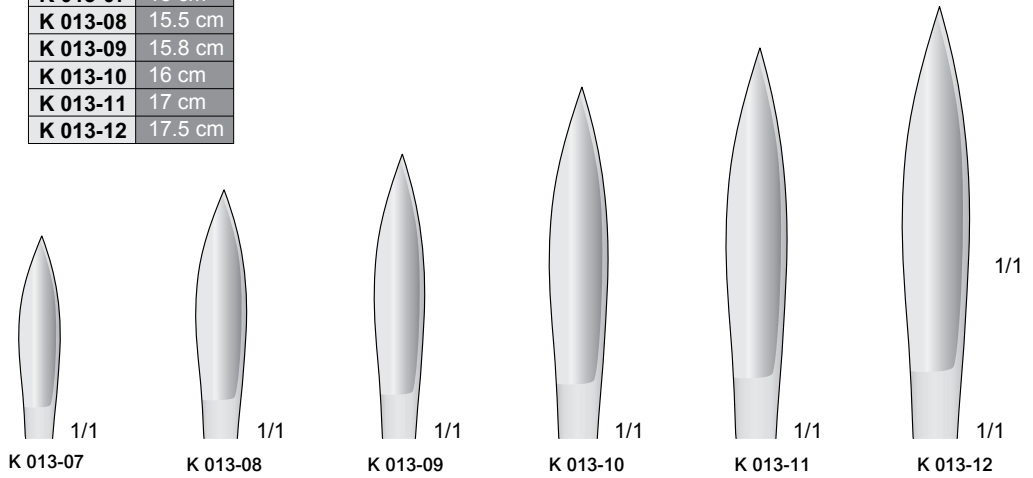

Manici per bisturi
 Scalpel handles
 Skalpellgriffe
 Manches de bistouris
 Mangos de bisturias

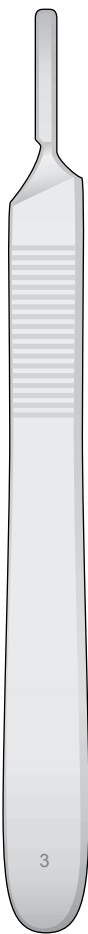
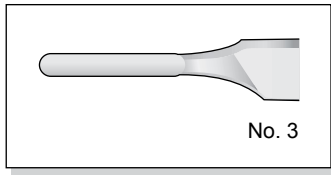

SH 014-03
Fig. 3



SH 015-03
Fig. 3M



SH 016-07
Fig. 7



SH 017-07
Fig. 7k



SH 018-05
Fig. 5

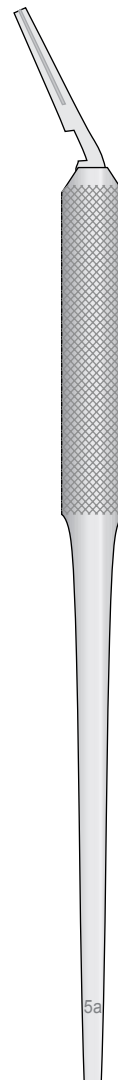

SH 019-05
Fig. 5a

1,5 mm

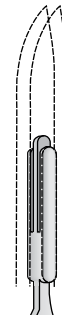

SH 020-01

2,5 mm

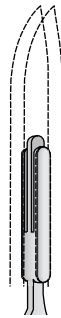

SH 020-02



SH 020-15 15.5 cm



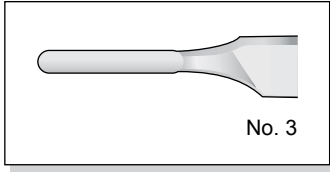

SH 021-03
Fig. 3L

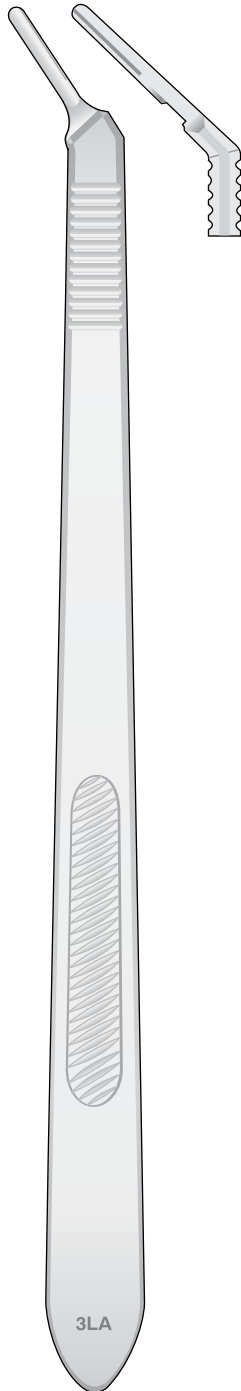

SH 022-03
Fig. 3LA



SH 023-21 21 cm

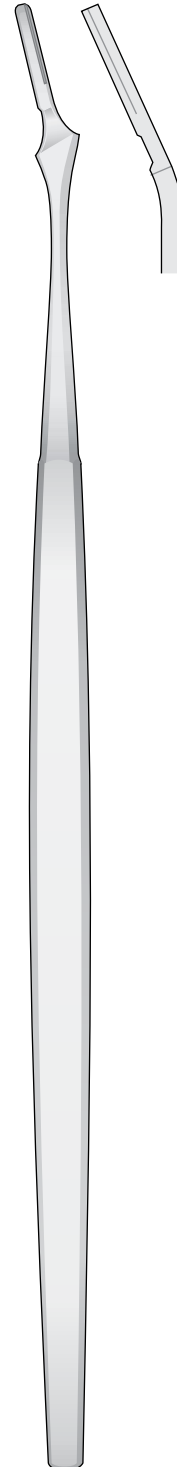

SH 024-21 21 cm

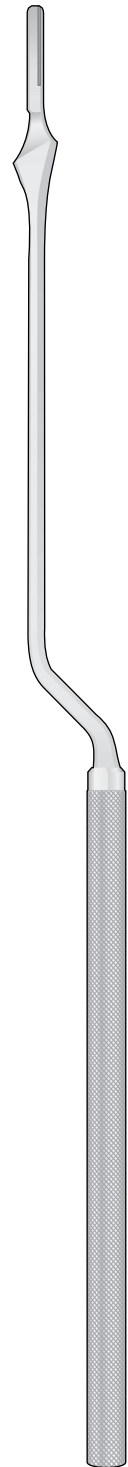

SH 025-21 21 cm

Manici per bisturi
Scalpel handles
Skalpellgriffe
Manches de bistouris
Mangos de bisturios

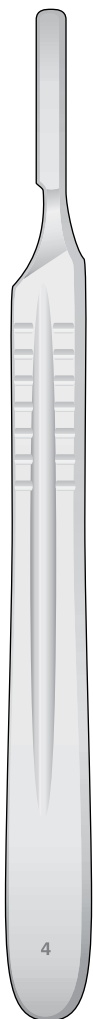
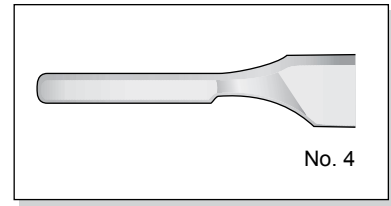

SH 026-04
Fig. 4

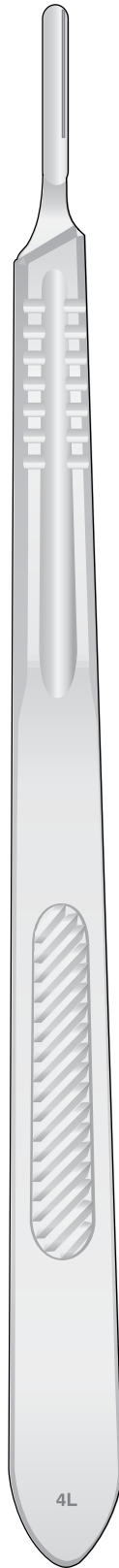

SH 027-04
Fig. 4L

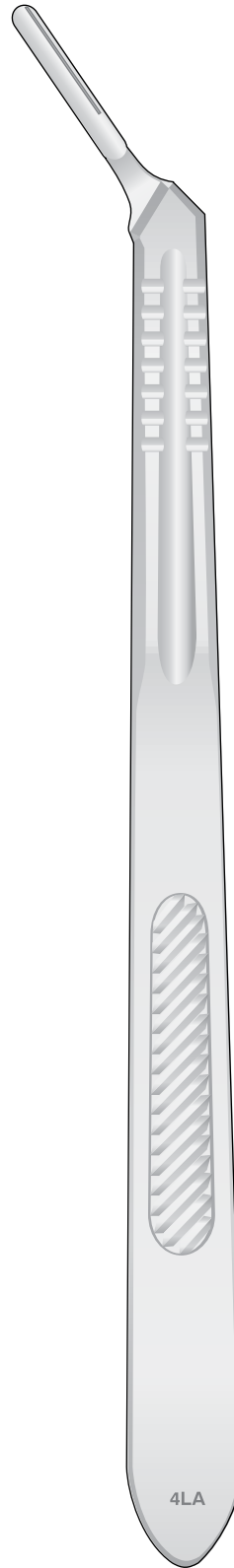

SH 028-04
Fig. 4LA

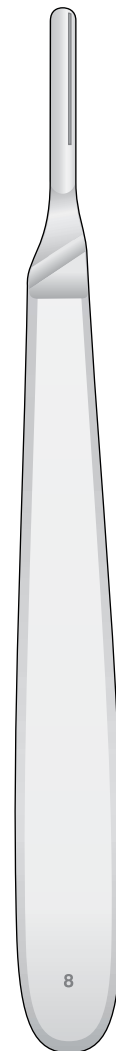

SH 029-08
Fig. 8

Scatole da 100 pezzi
Packungen à 100
Packages of 100 ea
Boîtes de 100 pièces
Cajas de 100 c/u

Doppio taglio
Double cutting
Doppelschneidig
Deux tranchants
Doble corta

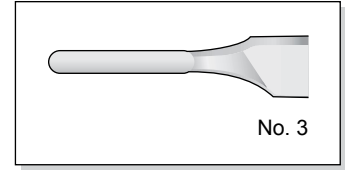

SB 030-10

Fig. 10



SB 031-11

Fig. 11



SB 032-12

Fig. 12



SB 033-12

Fig. 12D



SB 034-13

Fig. 13



SB 035-15

Fig. 15

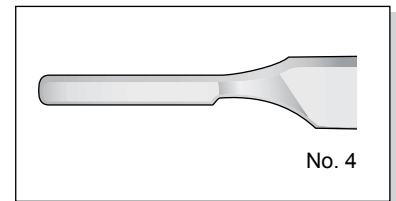

SB 036-18

Fig. 18

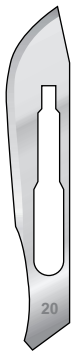

SB 037-20

Fig. 20



SB 038-21

Fig. 21



SB 039-22

Fig. 22



SB 040-23

Fig. 23



SB 041-24

Fig. 24



SB 042-25

Fig. 25

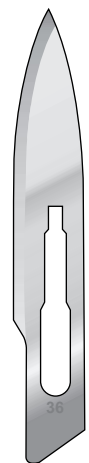

SB 043-36

Fig. 36

Manici e bisturi
 Scalpel handles, Knives
 Skalpellgriffe, Klinge
 Manches de bistouris, lame
 Mangos de bisturias, hojas



K 044-10

Conf. 10 pz.



K 045-10

Conf. 10 pz.



K 046-01

Conf. 1 pz.



K 047-10

Conf. 10 pz.



K 048-10

Conf. 10 pz.

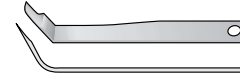

K 049-01

Conf. 1 pz.



K 050-10

Conf. 10 pz.



K 051-10

Conf. 10 pz.



K 052-01

Conf. 1 pz.



SH 053-10 10 cm



SH 054-15 15 cm



SH 055-13 13.5 cm



SH 056-15 15.5 cm



CASPAR
SH 056-18

SH 056-18 18 cm



1/1
SH 056-20

SH 056-20 20 cm

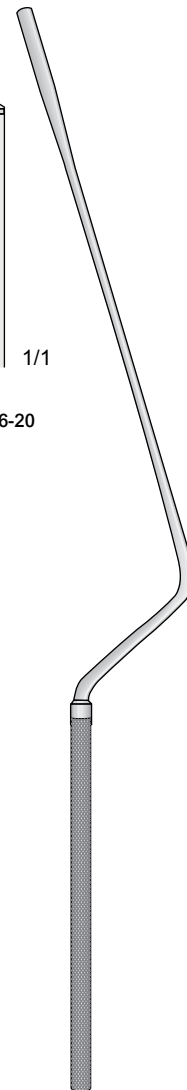

LANDOLT
SH 057-21 21 cm

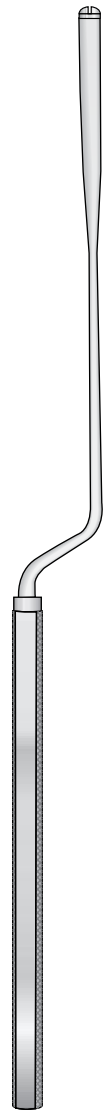

LANDOLT
SH 058-25 25 cm

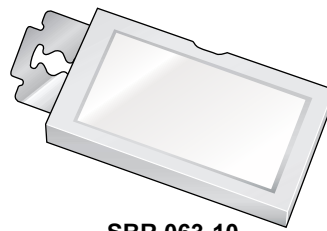

SBR 063-10

Scatola da 10 lame
Package 10 blades
Packung 10 Klingen
Boîte de 10 lames
Cajita de 10 hojas

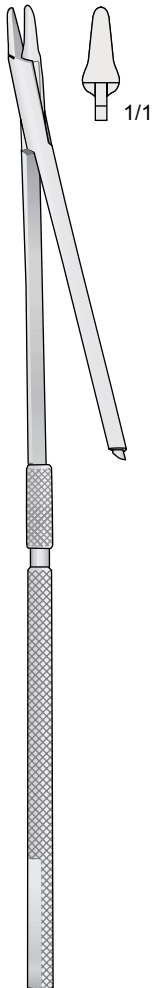

SBR 059-18 18 cm

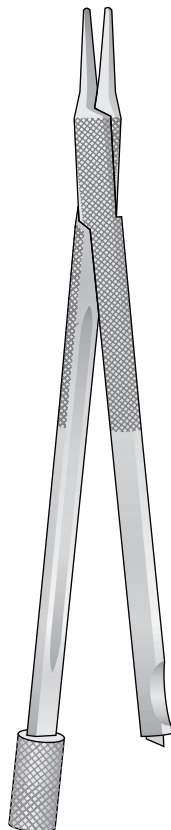

SBR 060-12 12 cm

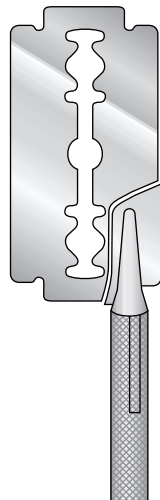

SBR 061-13 13.5 cm

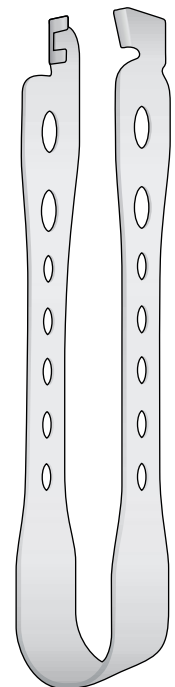
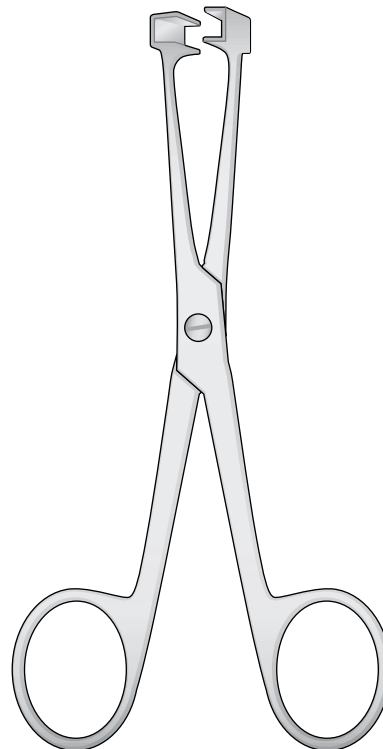

SBR 062-11 11.5 cm



we take a *closer look*



we take a closer look

+ SCISSORS

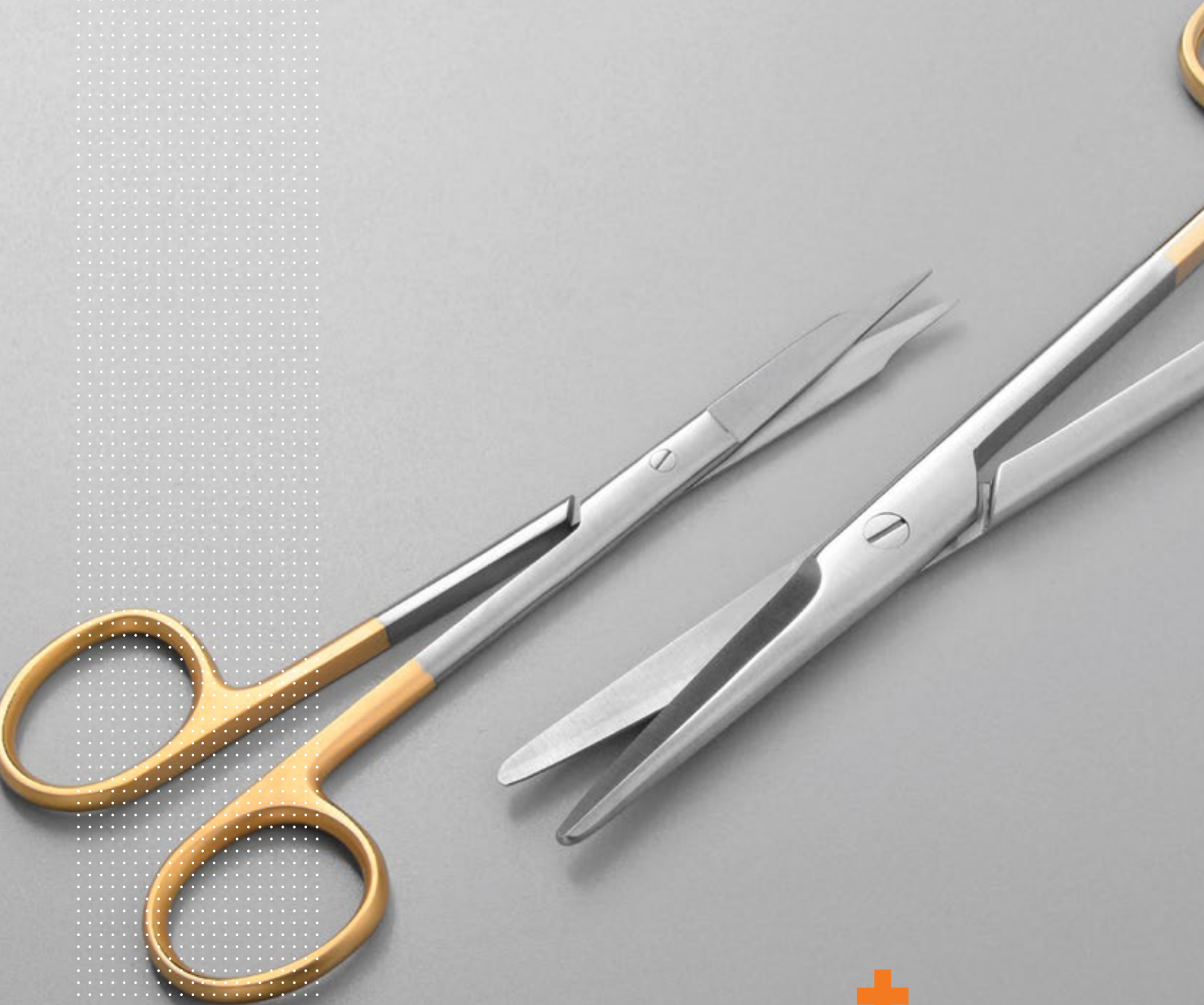

| Micro Scissors
| Surgical Scissors
| Ligature Scissors
| Wire & Plate

Micro forbici
 Micro scissors
 Micro Scheren
 Micro ciseaux
 Micro tijeras

Acuta - Sharp - Spitz
 Pointu - Agudas

Acuta - Sharp - Spitz
 Pointu - Agudas

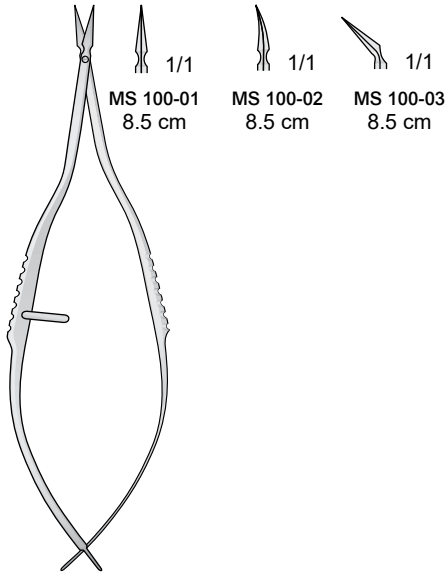

VANNAS
MS 100-01 / MS 100-03

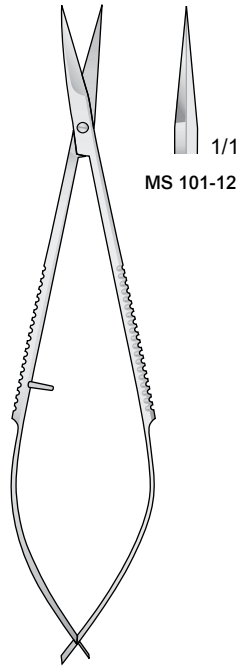

NOYES
MS 101-12 12 cm

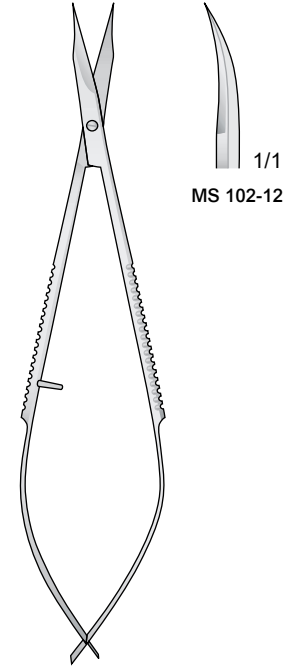

WESTCOTT
MS 102-12 12 cm

Acuta - Sharp - Spitz
 Pointu - Agudas

MS 104-01 16 cm
 MS 104-02 16 cm

MS 105-01 16 cm
 MS 105-02 16 cm

Acuta - Sharp
 Spitz - Pointu - Agudas

Smussa - Blunt
 Stumpf - Mousse - Romas

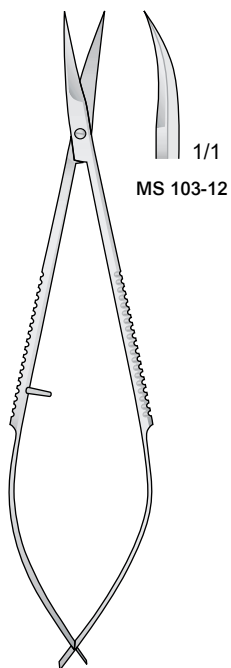

NOYES
MS 103-12 12 cm

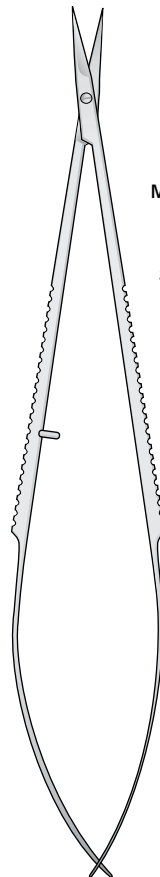

MS 104-01 / MS 104-02

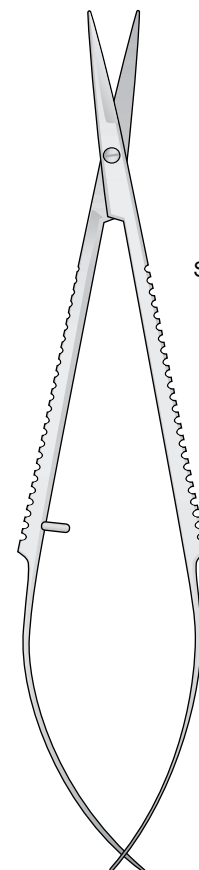

MS 105-01 / MS 105-02



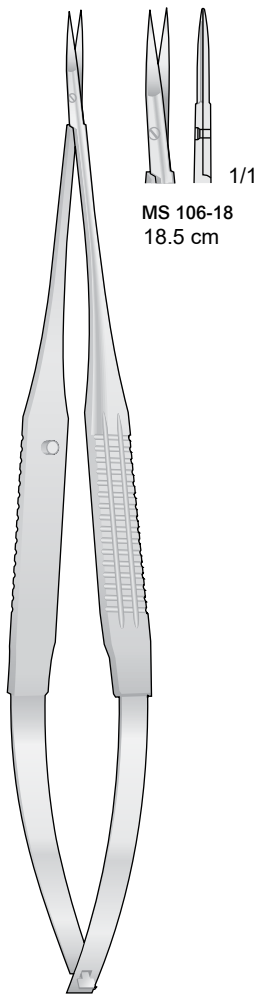

MS 106-18
18.5 cm

YASARGIL

MS 106-18 18.5 cm

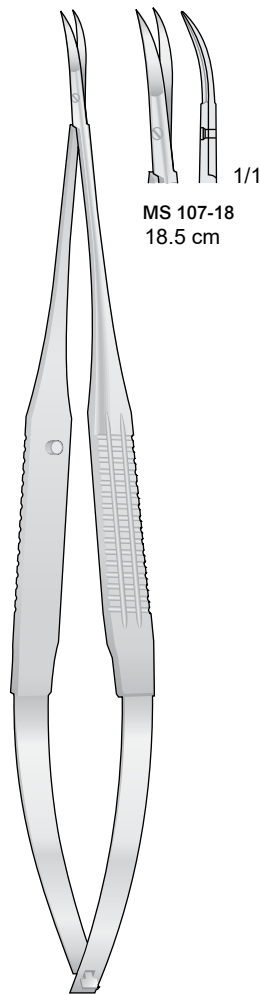

MS 107-18
18.5 cm

JACOBSON

MS 107-18 18.5 cm

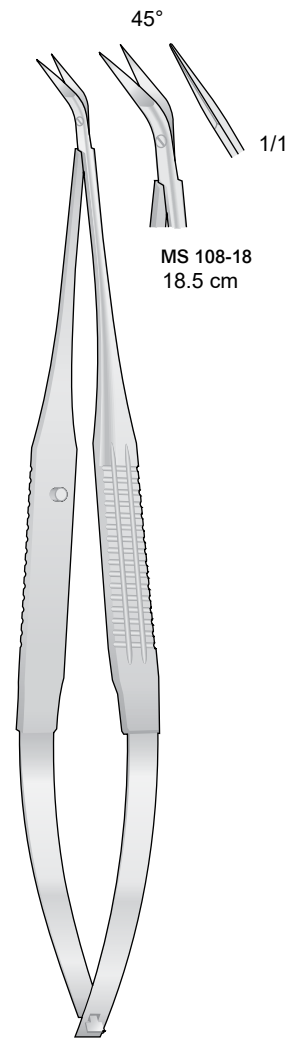

MS 108-18
18.5 cm

POTTS-YASARGIL

MS 108-18 18.5 cm

Micro forbici
Micro scissors
Micro Scheren
Micro ciseaux
Micro tijeras

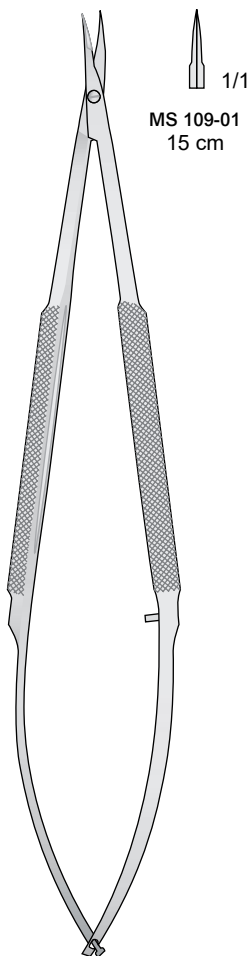

MS 109-01 / MS 109-02

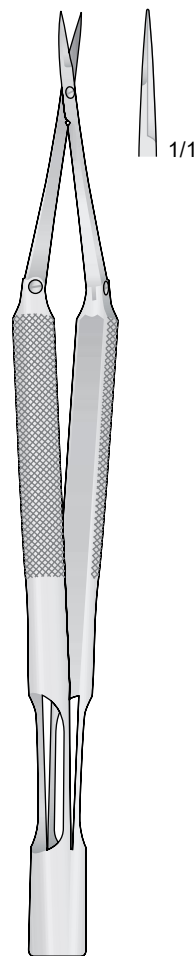

MS 110-15 15 cm

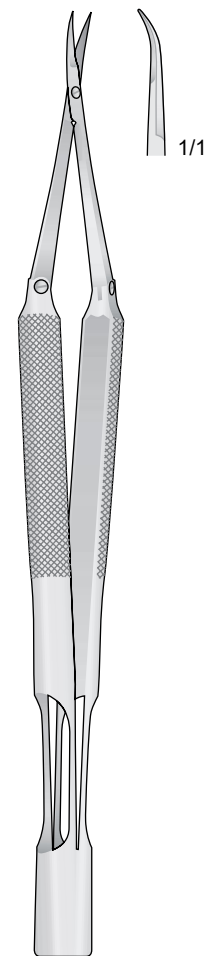

MS 111-15 15 cm

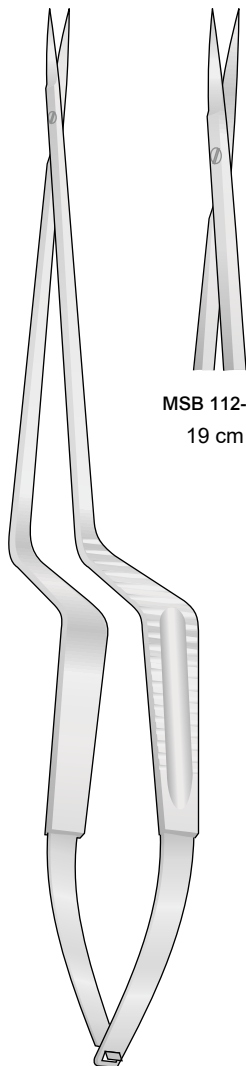

MSB 112-01
19 cm

MSB 112-02
19 cm

MSB 112-03
19 cm

MSB 112-04
19 cm

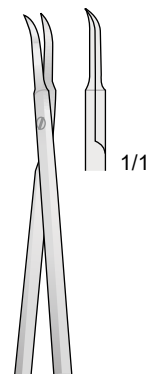
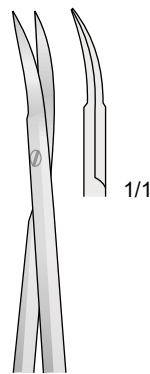

MSB 112-01 / MSB 112-04

Micro forbici a baionetta
 Micro scissor bayonet-shared
 Micro-Federschere Bayonettförmig
 Micro ciseaux baionette
 Micro tijeras Bajonet

Dentellata
 Sawedge
 Gezahnt
 Dentelés
 Dentadas

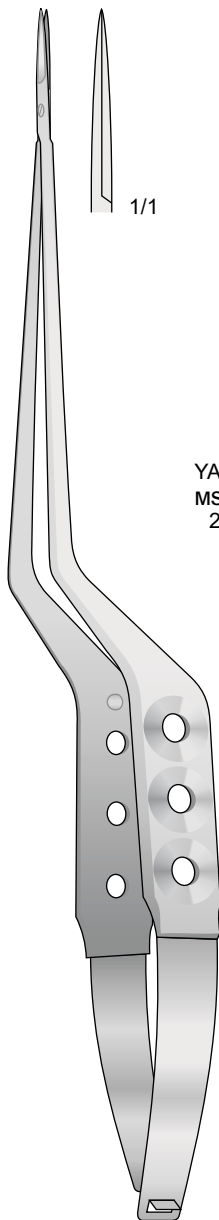

YASARGIL
MSB 113-01 / MSB 113-02

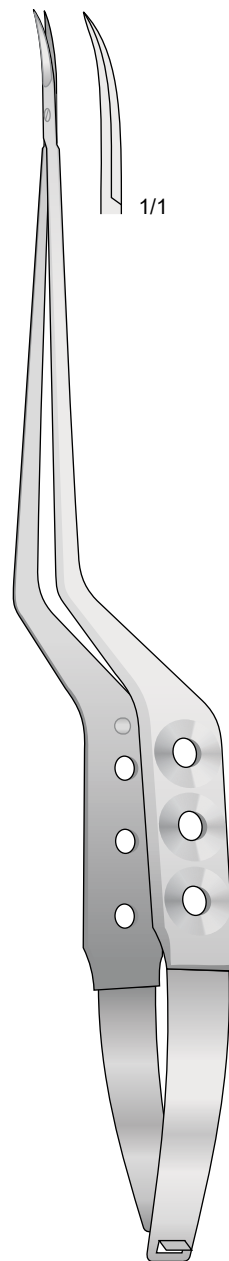
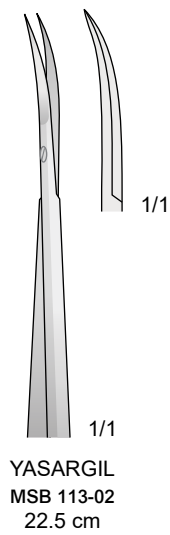
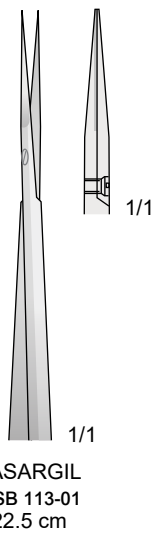

YASARGIL
MSB 114-24 24.5 cm

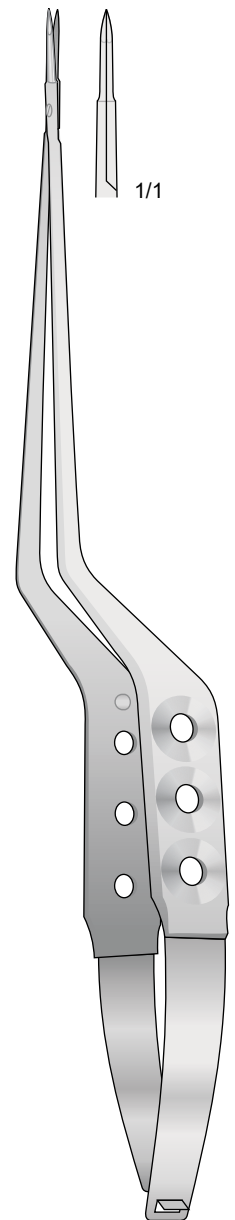

VANNAS
MSB 115-22 22.5 cm



Acute
Pointed
Spitz
Pointus
Agudas

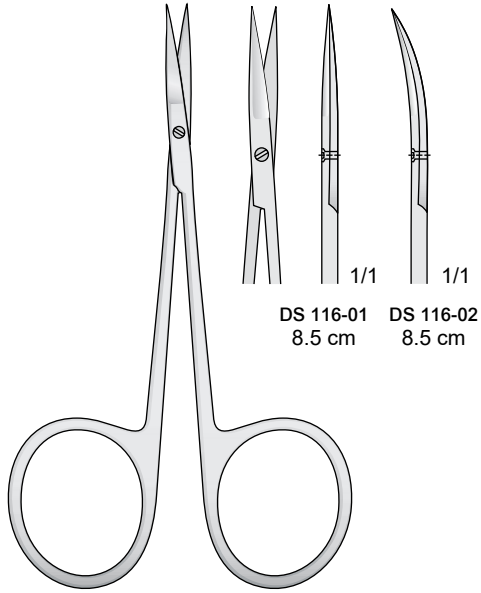

MICRO-IRIS
DS 116-01 / DS 116-02

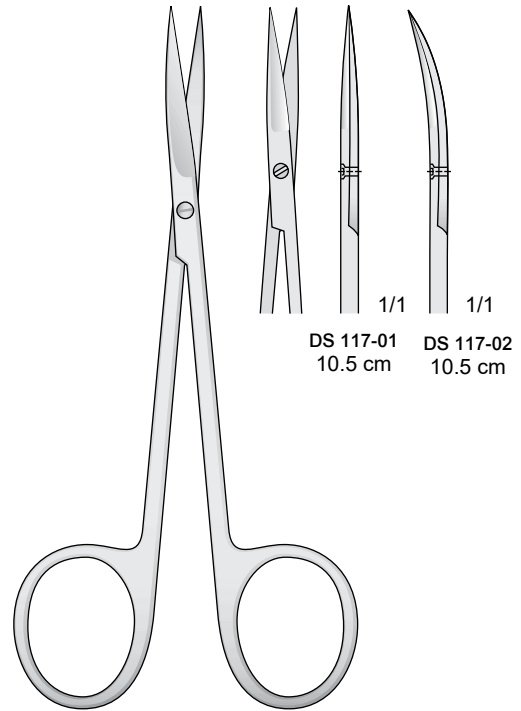

DS 117-01 / DS 117-02

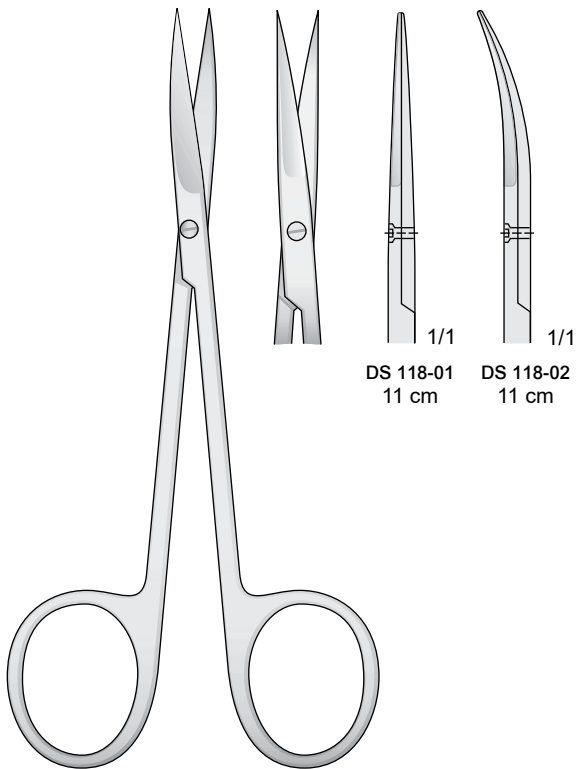

IRIS
DS 118-01 / DS 118-02

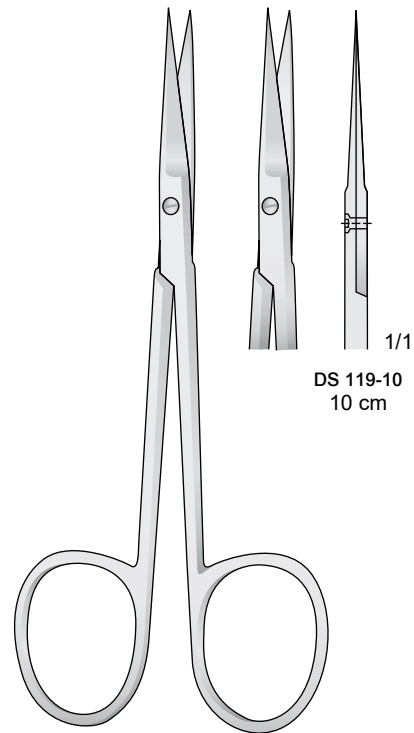

DS 119-10 10 cm

Forbici delicate
 Delicate scissors
 Feine Scheren
 Ciseaux délicate
 Tijeras finas

Smussa - Blunt
 Stumpf - Émoussé - Romo

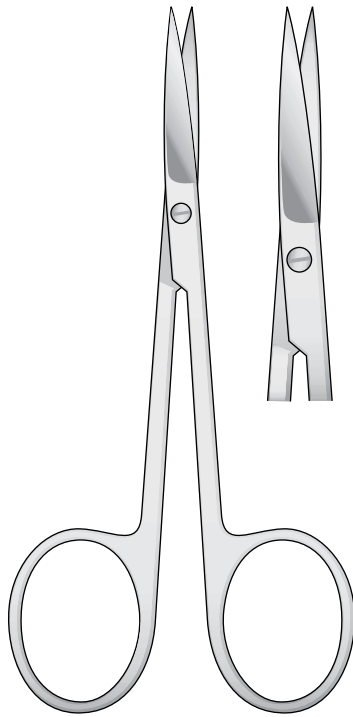

DS 120-01 / DS 120-02

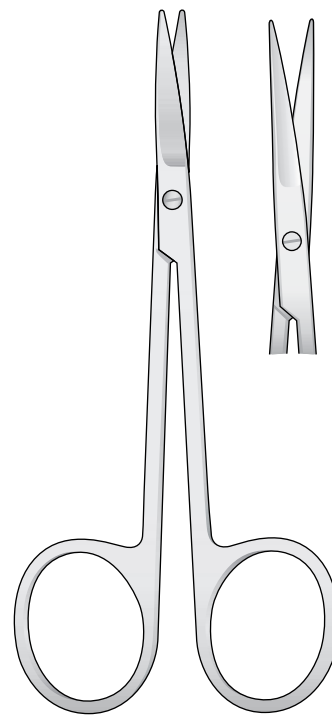
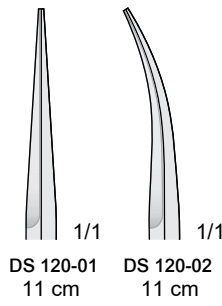

DS 121-01 / DS 121-02

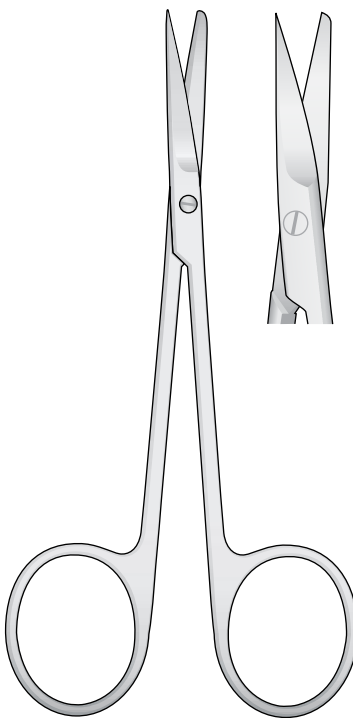
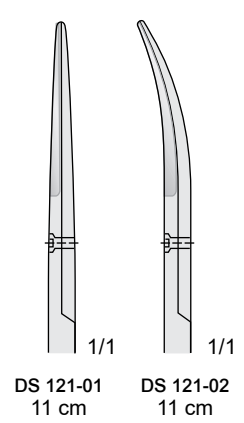

DS 122-01 / DS 122-02

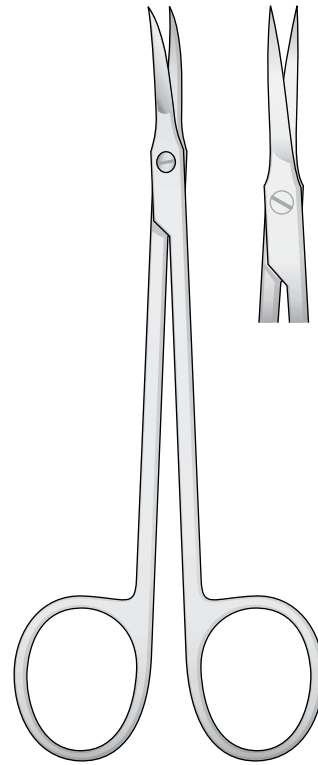
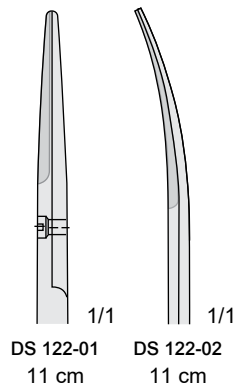

DS 123-01 / DS 123-02

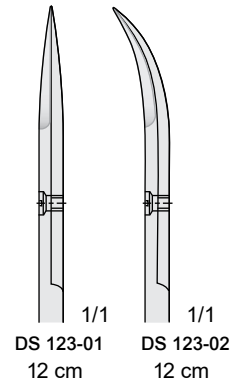

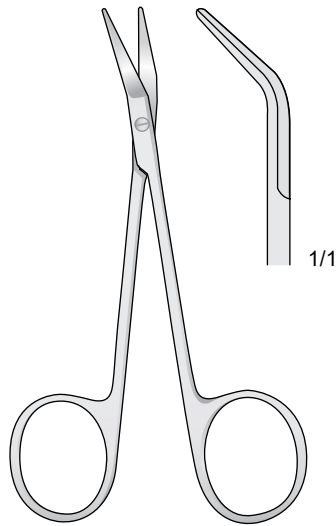

GRAEFE

DS 124-10 10 cm

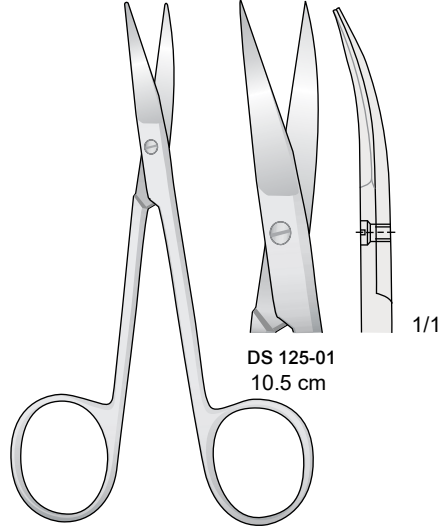

COTTLE-MASING

DS 125-01/ DS 125-02

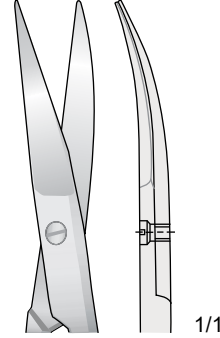

DS 125-02

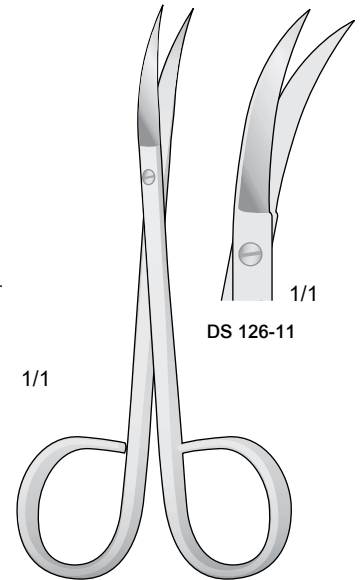

DS 126-11

DS 126-11 11.5 cm

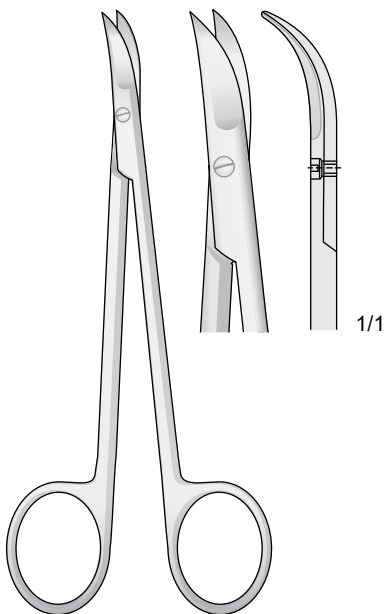

CHADWICK

DS 127-11 11.5 cm

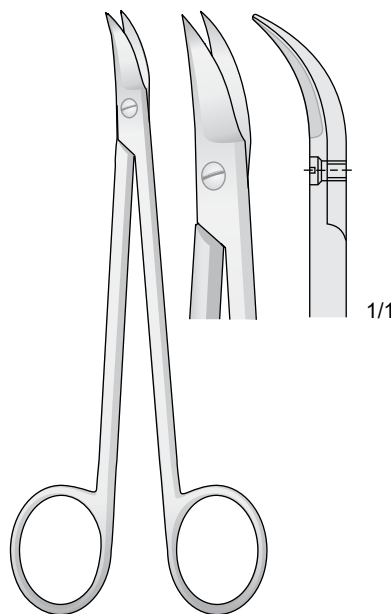

QUINBY

DS 128-13 13 cm

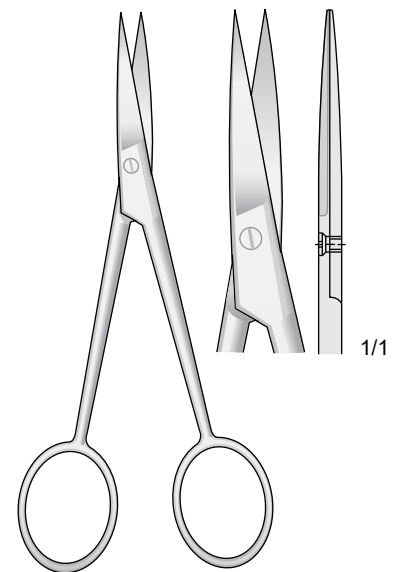

DS 129-11 11 cm

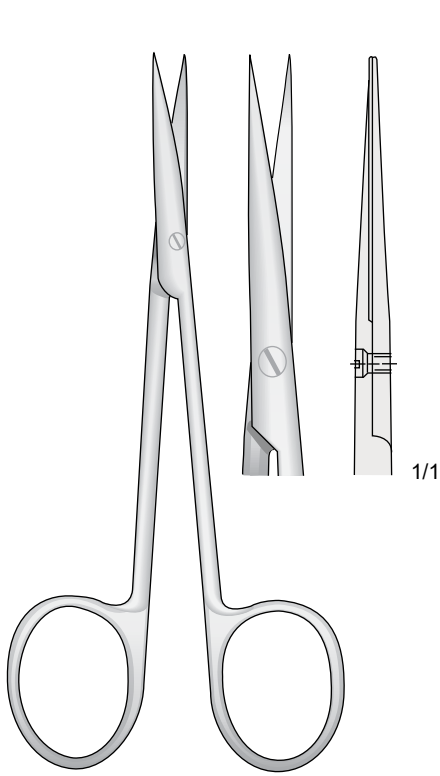

KILNER
OS 130-11 11.5 cm

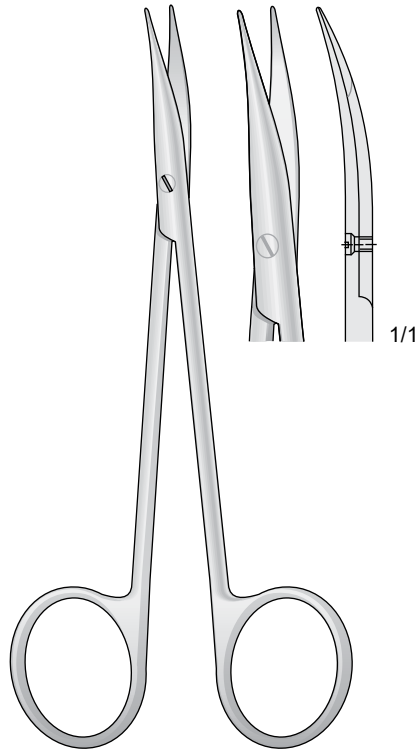

JAMESON-WERBER
OS 131-13 13 cm

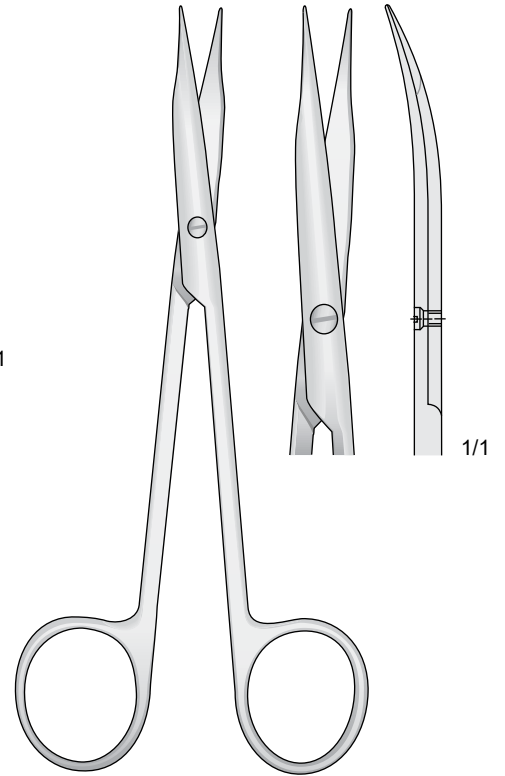

JAMESON
OS 132-14 14.5 cm

Smussa - Blunt
 Stumpf - Émoussé - Romo

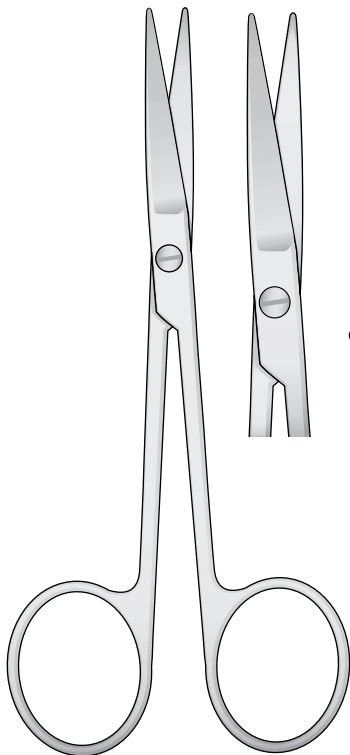

OS 133-01 / OS 133-02

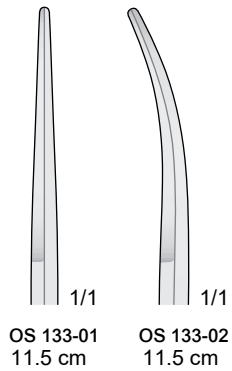

Acuta - Sharp
 Spitz - Aigu - Agudo

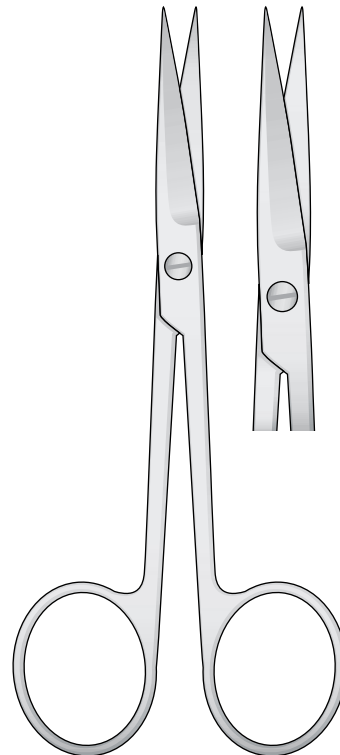

OS 134-01 / OS 134-02

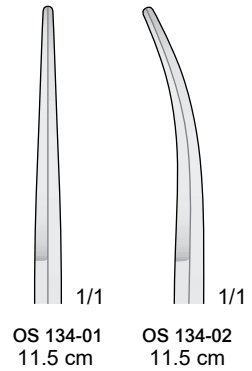

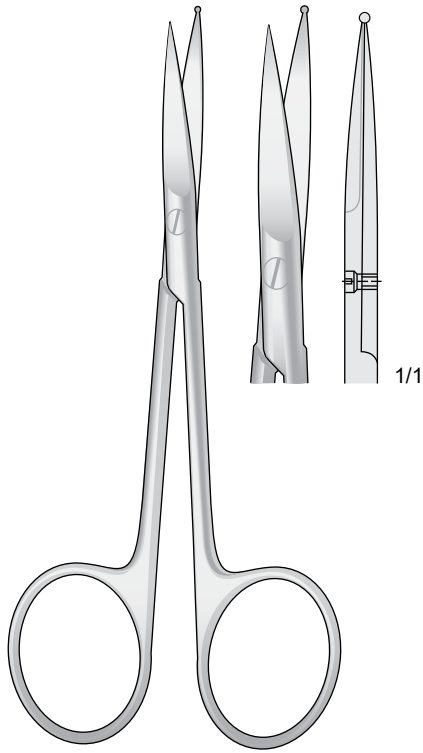

DS 135-12 12 cm

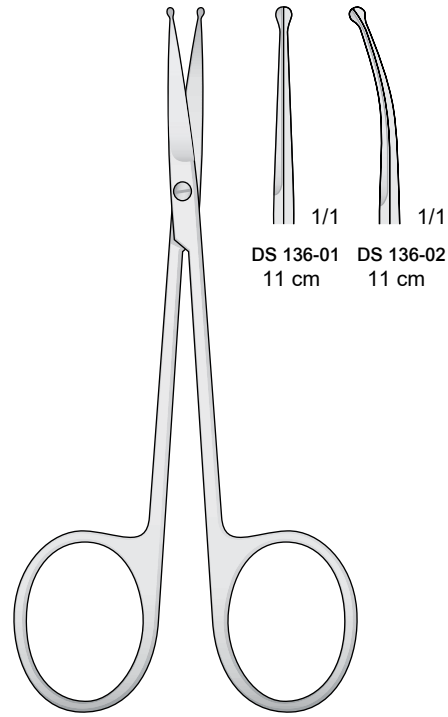

DS 136-01 / DS 136-02

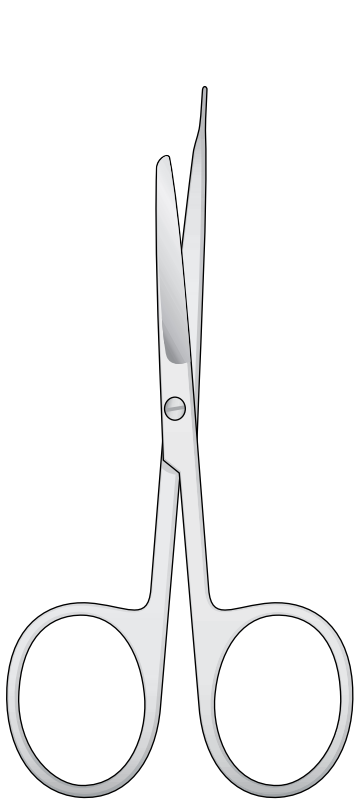

DS 137-10 10 cm

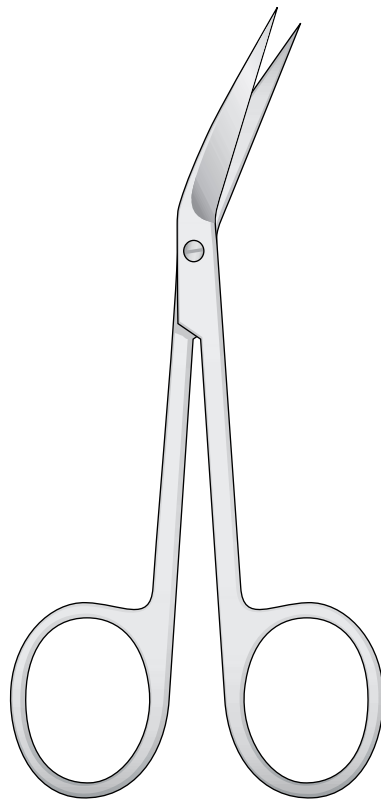

DS 138-11 11.5 cm

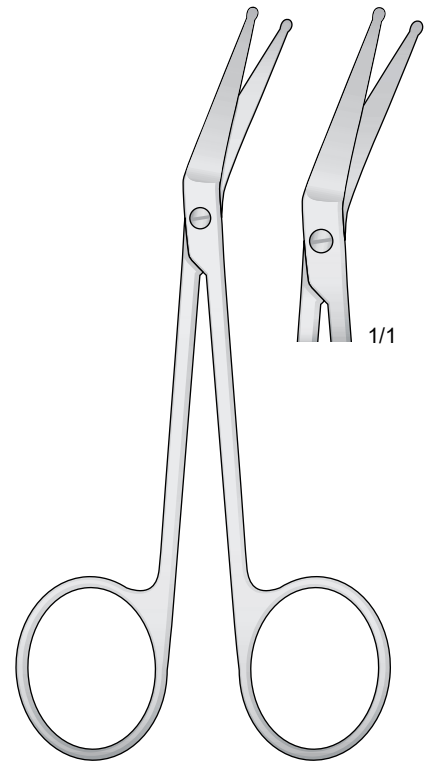

LOCKLIN MOD.
DS 139-11 11 cm

Dentellata - Sawedge - Gezahnt - Dentelé - Dentadas

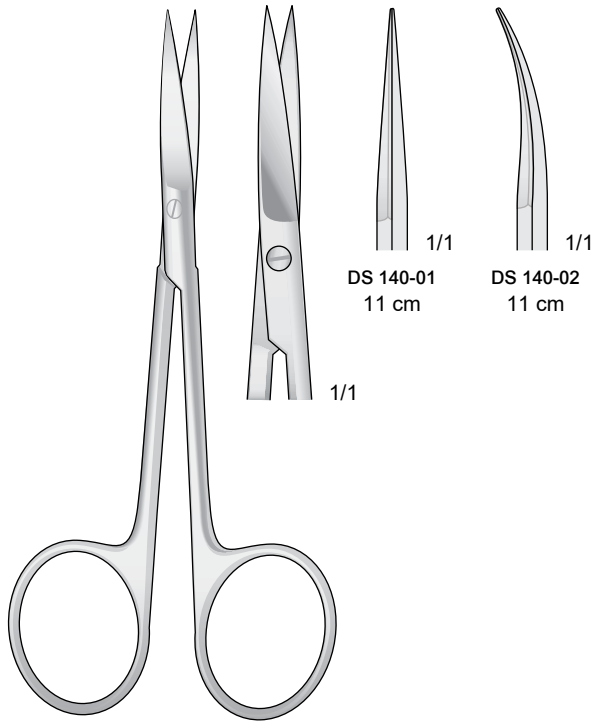

DS 140-01 / DS 140-02

Dentellata - Sawedge - Gezahnt - Dentelé - Dentadas

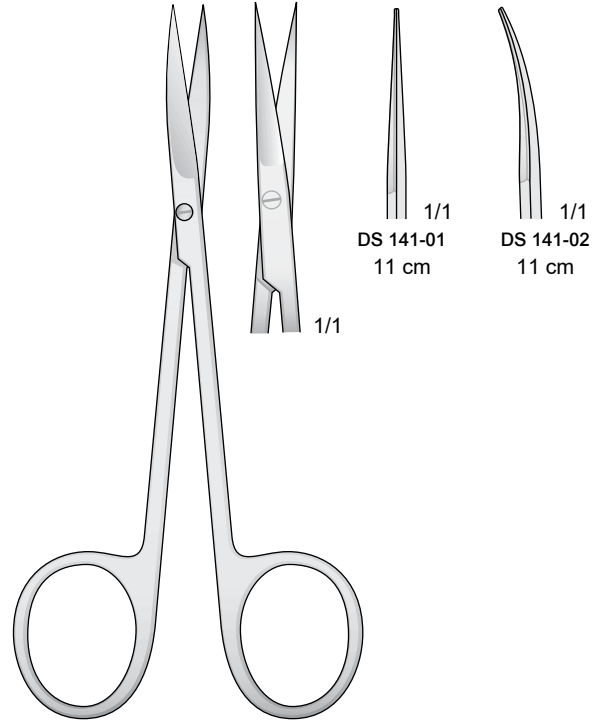

DS 141-01 / DS 141-02

Dentellata - Sawedge - Gezahnt - Dentelé - Dentadas

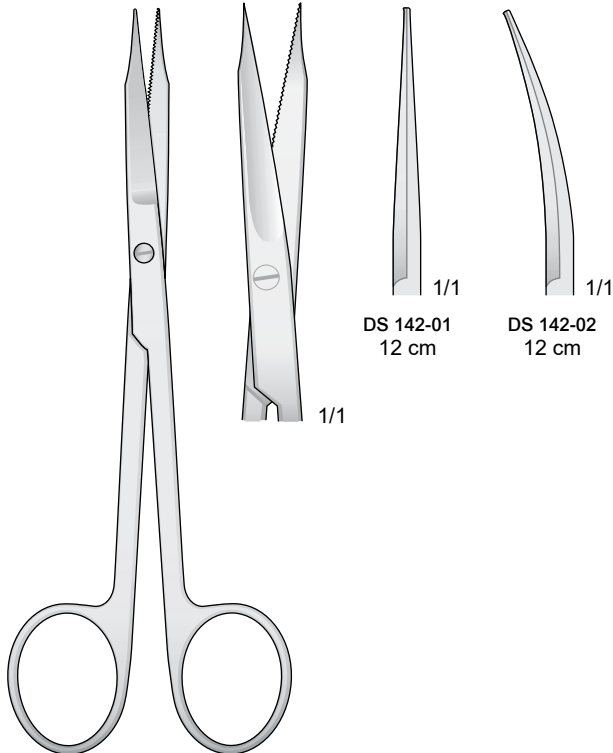

**GOLDMAN-FOX
 DS 142-01 / DS 142-02**

Dentellate
Saw edge
Gezahnt
Dentelé
Dentadas

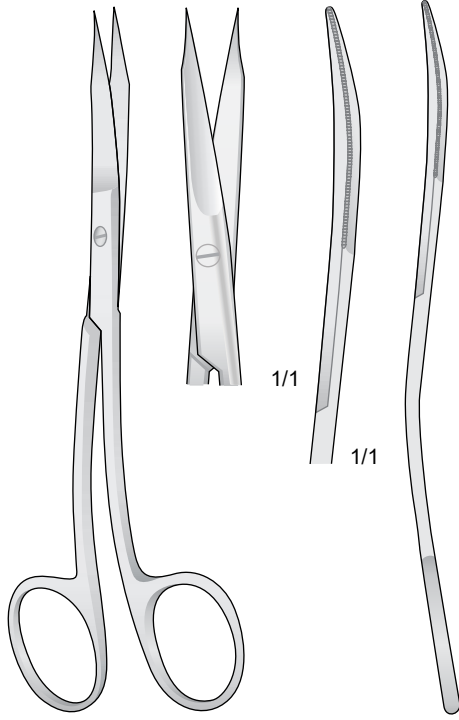

GOLDMAN-FOX S FORM

DS 143-13 13 cm

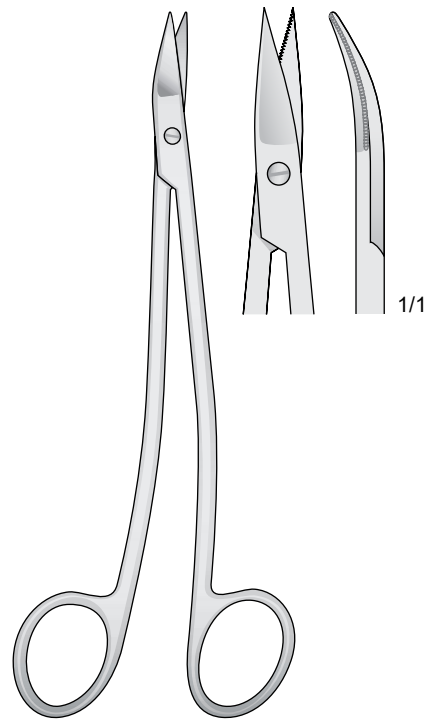

NEUMANN

DS 144-13 13 cm

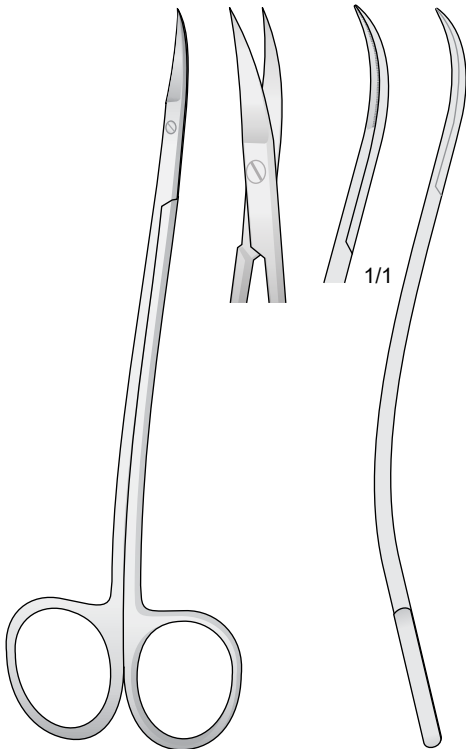

LA GRANGE

DS 145-11 11.5 cm

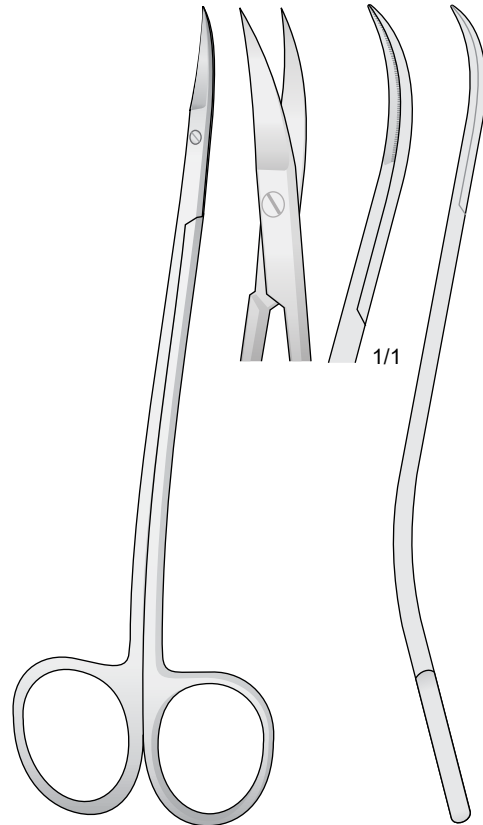

LA GRANGE

DS 146-15 15.5 cm

Forbici delicate
 Delicate scissors
 Feine Scheren
 Ciseaux délicate
 Tijeras finas

Smusse - Blunt - Stumpf - Mousses - Romas

Acute - Pointed - Spitz - Pointus - Agudas

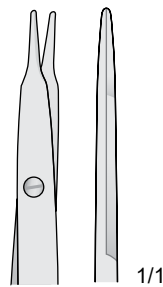
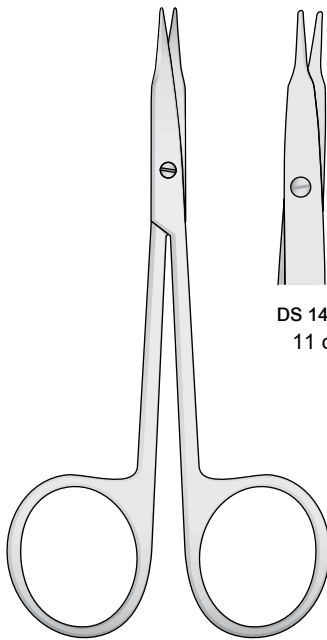

DS 147-01
11 cm

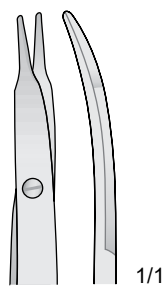

DS 147-02
11 cm

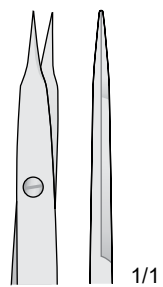

DS 147-03
11 cm

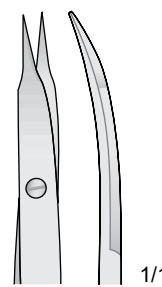

DS 147-04
11 cm

STEVENS

DS 147-01 / DS 147-04

Smussa - Blunt - Stumpf
 Mousse - Romas

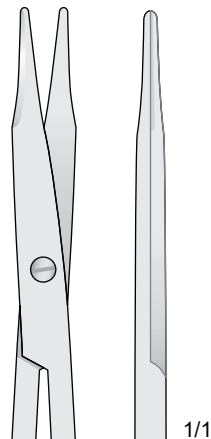
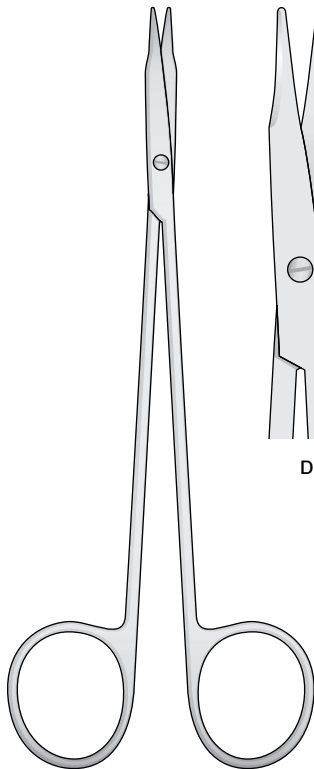

DS 148-01
15 cm

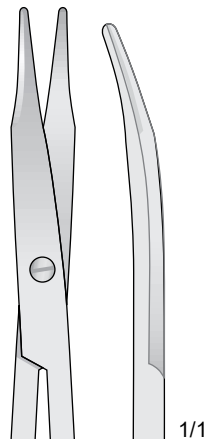

DS 148-02
15 cm

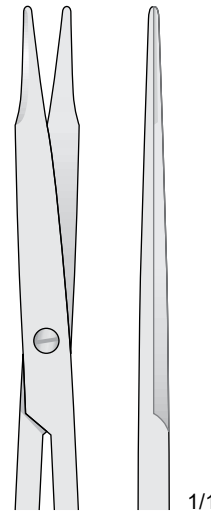

DS 148-03
18 cm

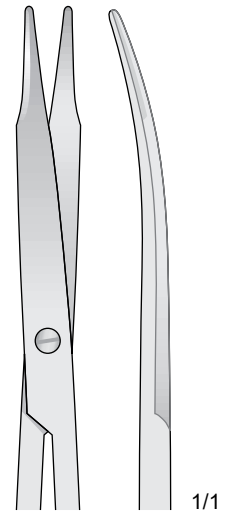

DS 148-04
18 cm

REYNOLDS

DS 148-01 / DS 148-04



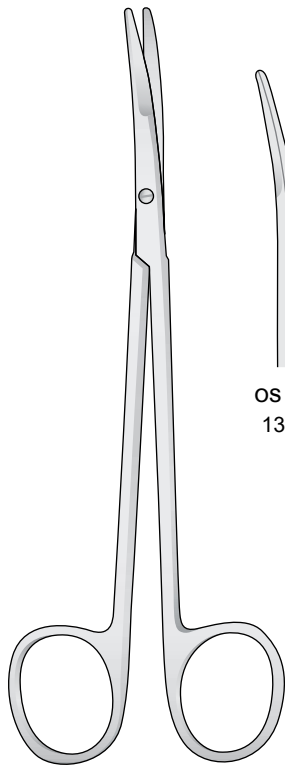

GLASSMAN
OS 149-01 / OS 149-02

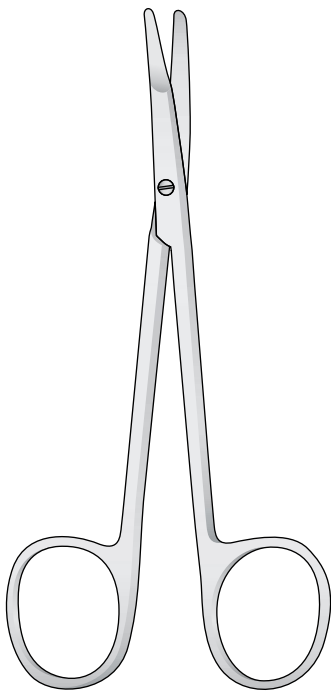
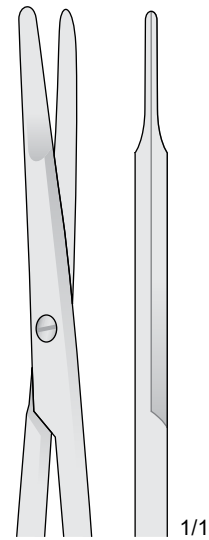
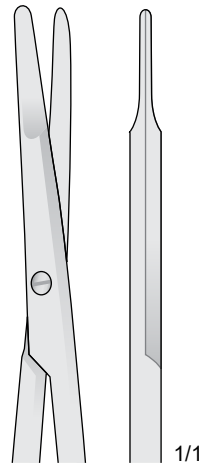
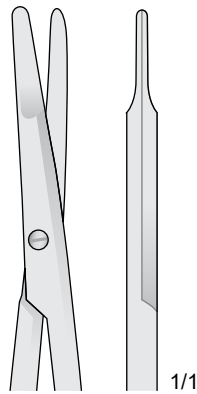
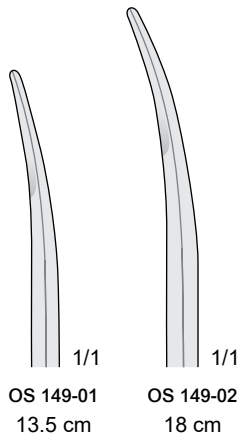

KILNER
OS 150-01 / OS 150-06

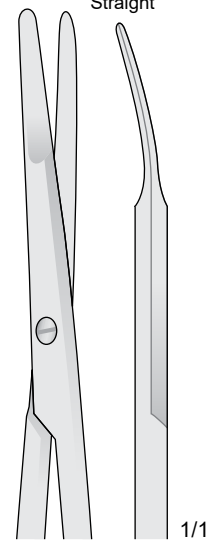
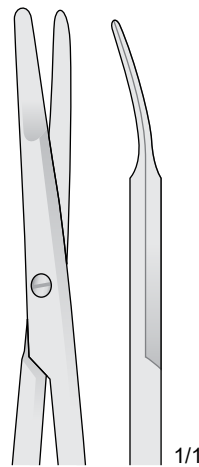
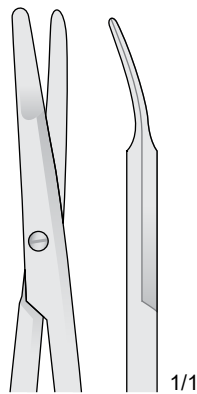

Forbici chirurgich
 Operating scissor
 Chirurgische Schere
 Ciseaux chirurgicau
 Tijeras para cirurgia general

Dentellate
 Saw edge
 Gezahnt
 Dentelés
 Dentadas

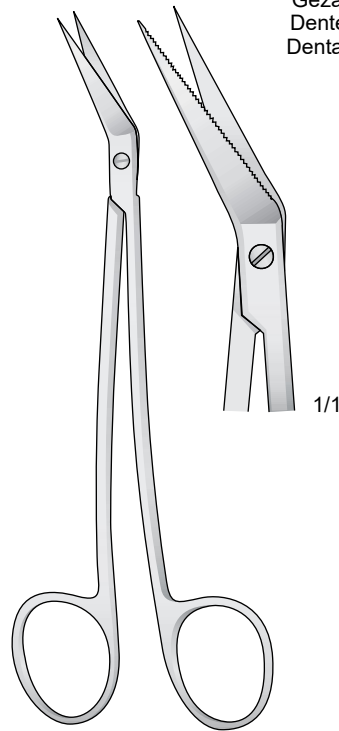

LOCKLIN
OS 151-16 16 cm

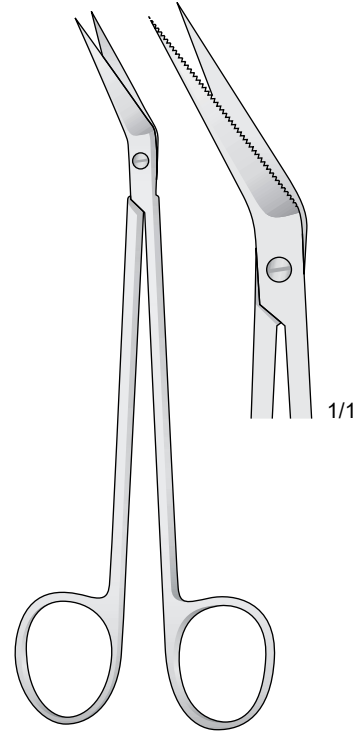

LOCKLIN
OS 152-16 16 cm

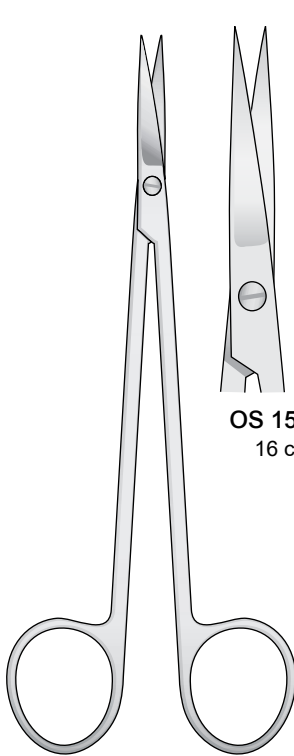

KELLY
OS 153-01 / OS 153-02

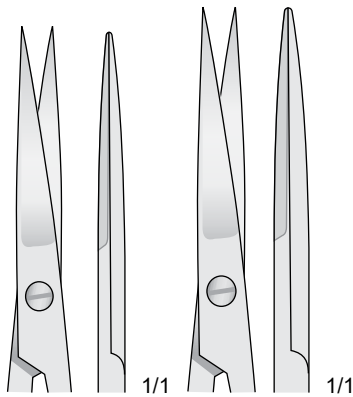

OS 153-01
 16 cm

OS 153-02
 18 cm

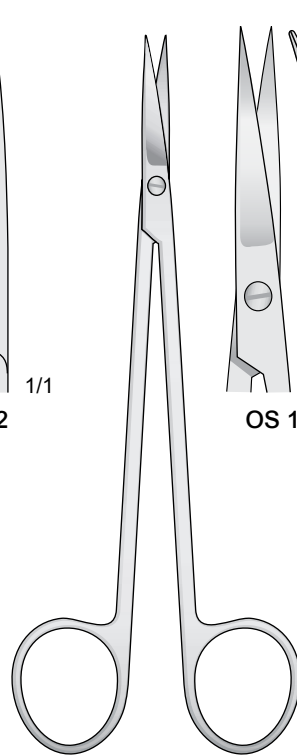

KELLY
OS 154-01 / OS 154-02

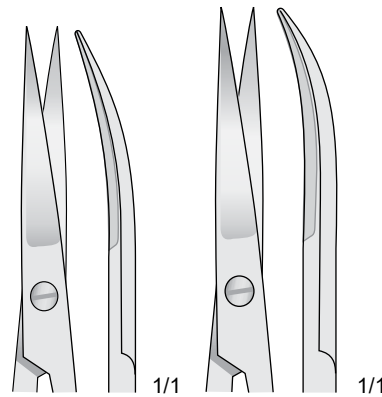

OS 154-01

OS 154-02

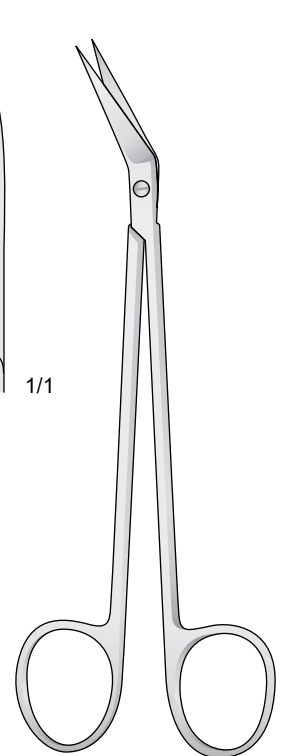

KELLY
OS 155-16 16 cm

Standard

Smusse
Blunt
Stumpf
Mousses
Romas

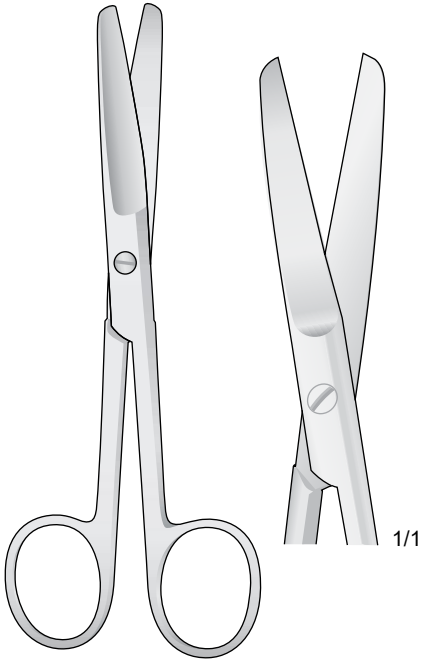

OS 156-01
13 cm

OS 156-02
14.5 cm

OS 156-03
16.5 cm

OS 156-04
18.5 cm

OS 156-01 / OS 156-04

Smusse - Blunt
Stumpf - Mousses
Romas

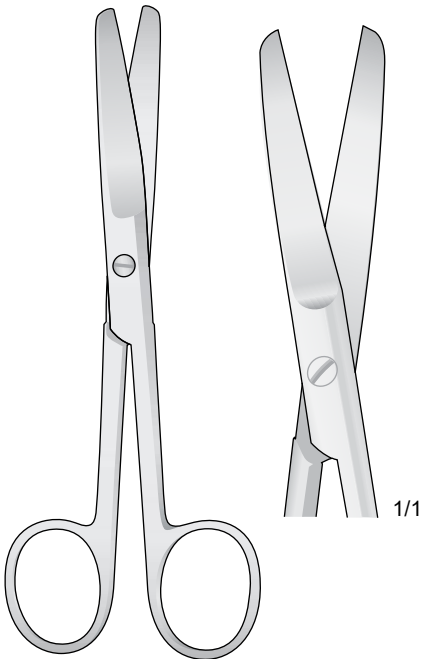

OS 157-01
13 cm

OS 157-02
14.5 cm

OS 157-03
16.5 cm

OS 157-04
18.5 cm

OS 157-01 / OS 157-04

Forbici chirurgich
 Operating scissor
 Chirurgische Schere
 Ciseaux chirurgicau
 Tijeras para cirurgia general

Standard

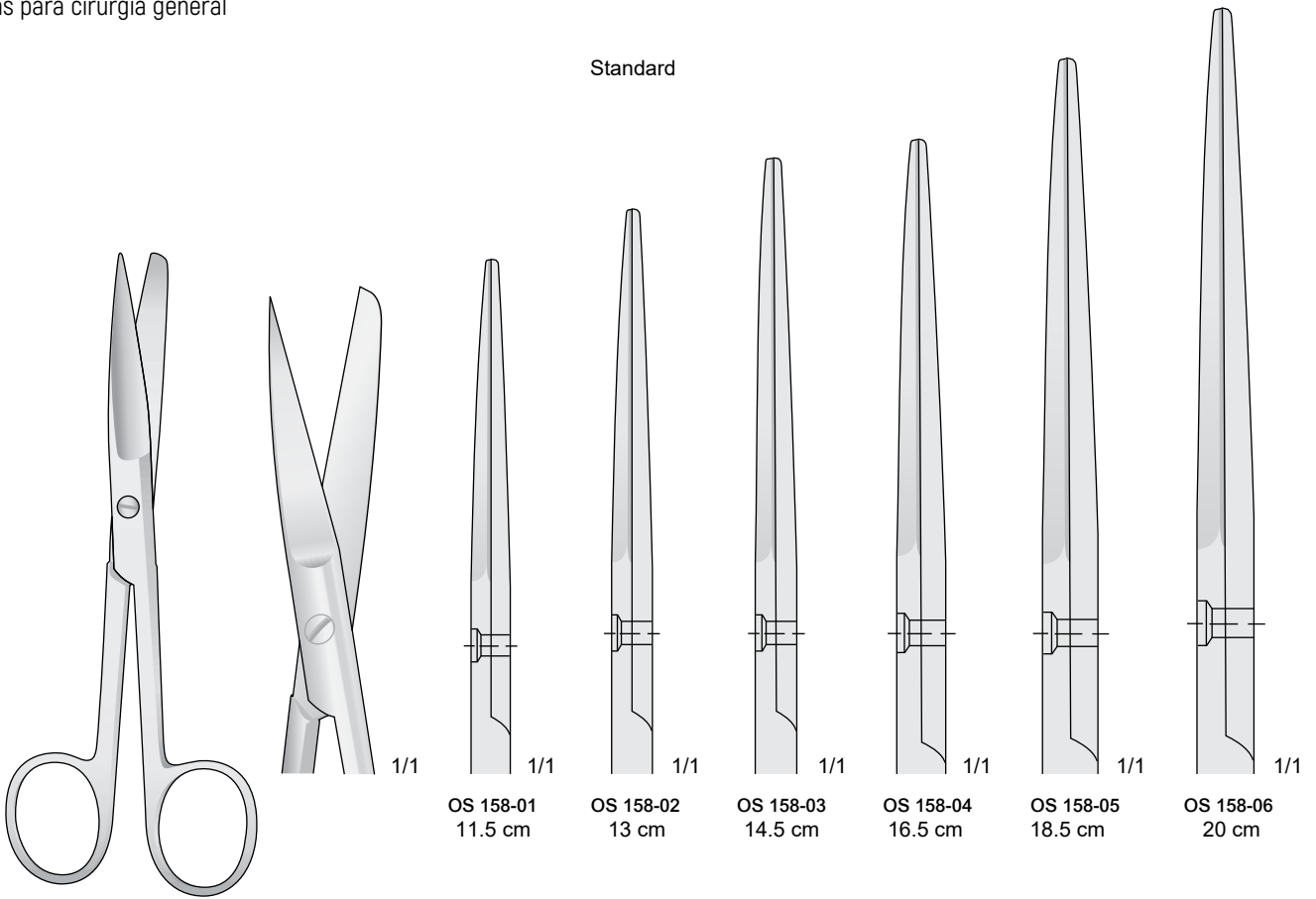

OS 158-01 / OS 158-06

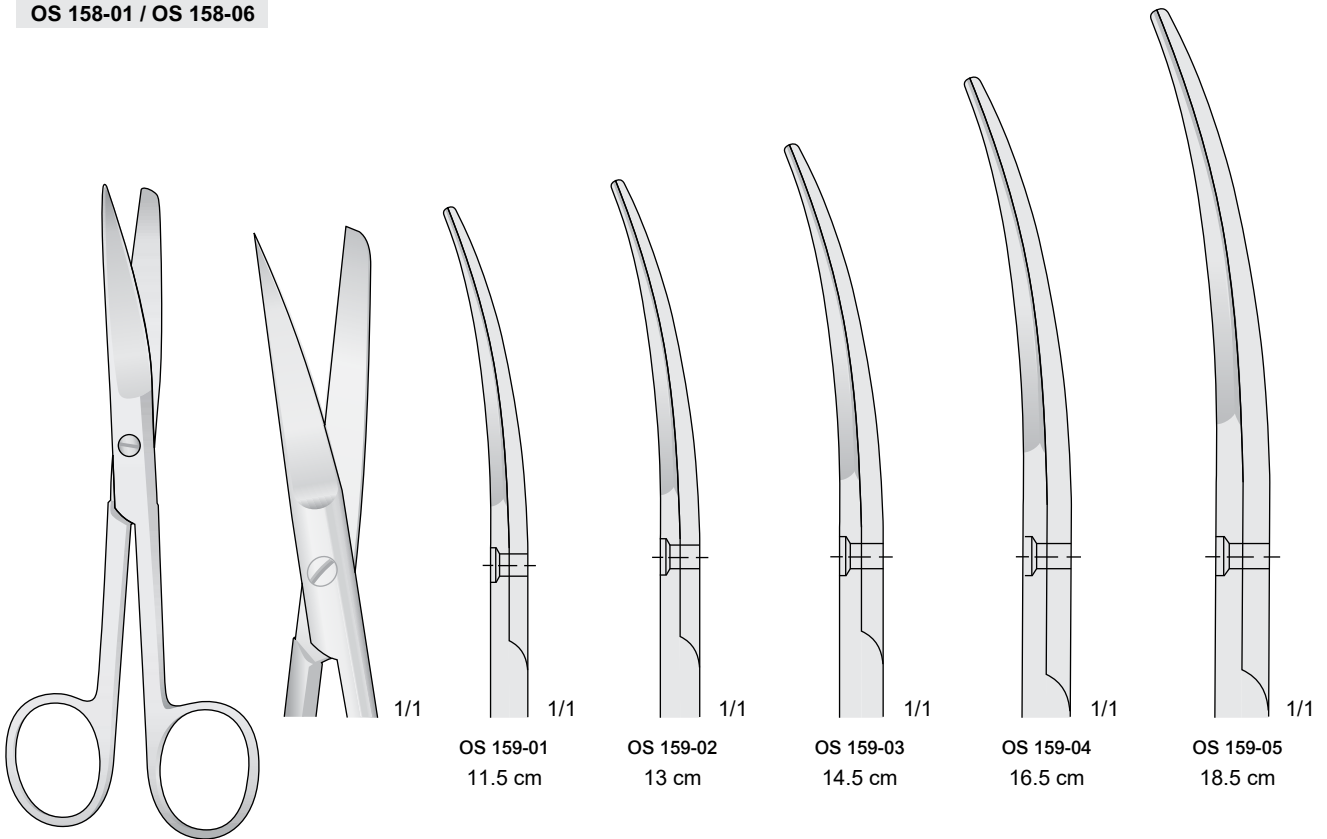

OS 159-01 / OS 159-05

Standard

Acuta - Sharp
Spitz - Aigu - Agudo

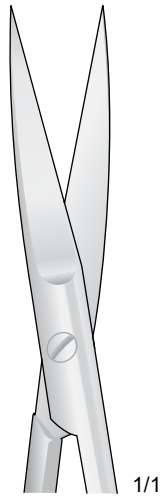
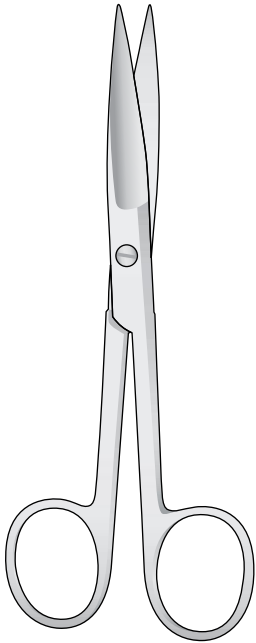

1/1



1/1

OS 160-01
13 cm



1/1

OS 160-02
14.5 cm



1/1

OS 160-03
16.5 cm

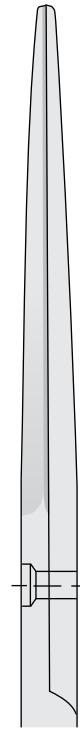

1/1

OS 160-04
18.5 cm

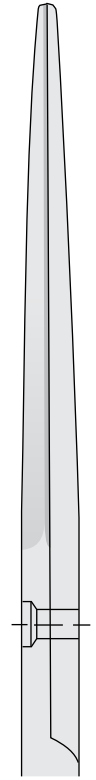

1/1

OS 160-05
20 cm

OS 160-01 / OS 160-05

Acuta - Sharp
Spitz - Aigu - Agudo

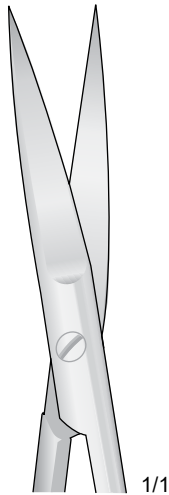
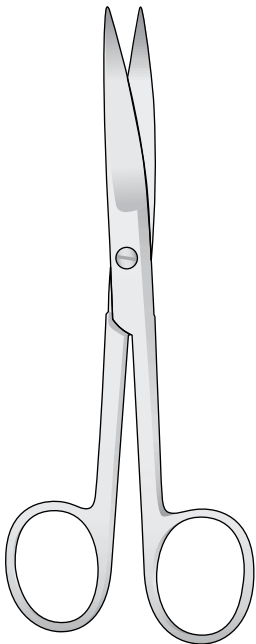

1/1

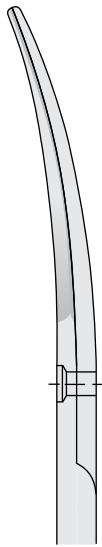

1/1

OS 161-01
13 cm

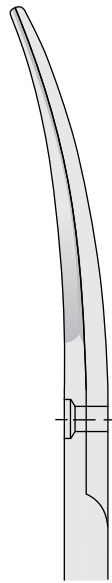

1/1

OS 161-02
14.5 cm



1/1

OS 161-03
16.5 cm

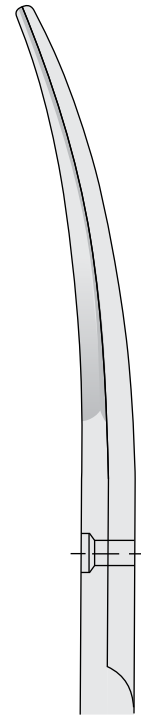

1/1

OS 161-04
18.5 cm

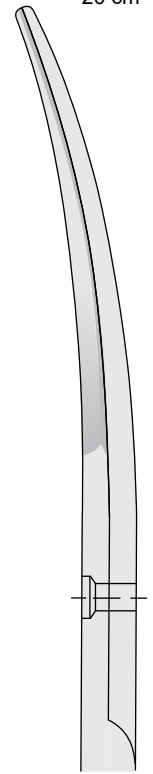

1/1

OS 161-05
20 cm

OS 161-01 / OS 161-05

Forbici chirurgich
 Operating scissor
 Chirurgische Schere
 Ciseaux chirurgicau
 Tijeras para cirugia general

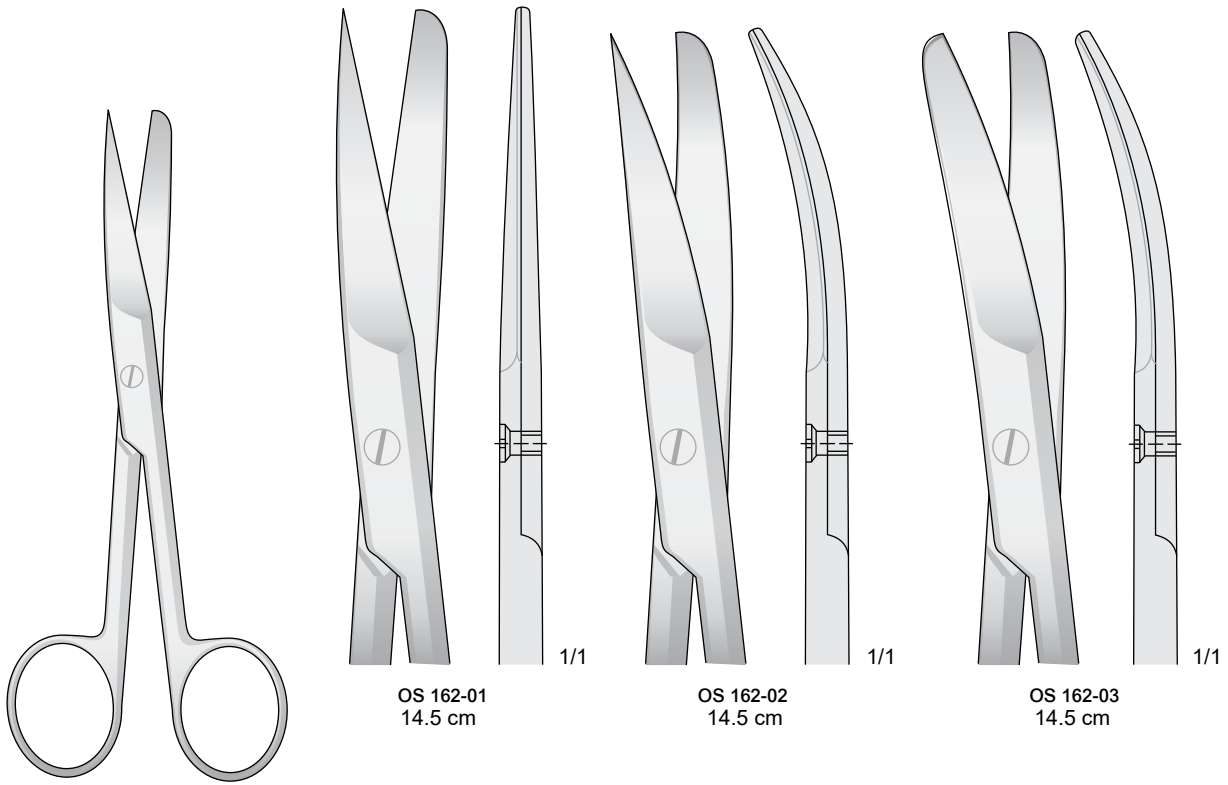

DEAVER

OS 162-01 / OS 162-03

Forbici da incisione - Incision scissors
 Inzisionscheren - Ciseaux à incision
 Tijeras para incisión

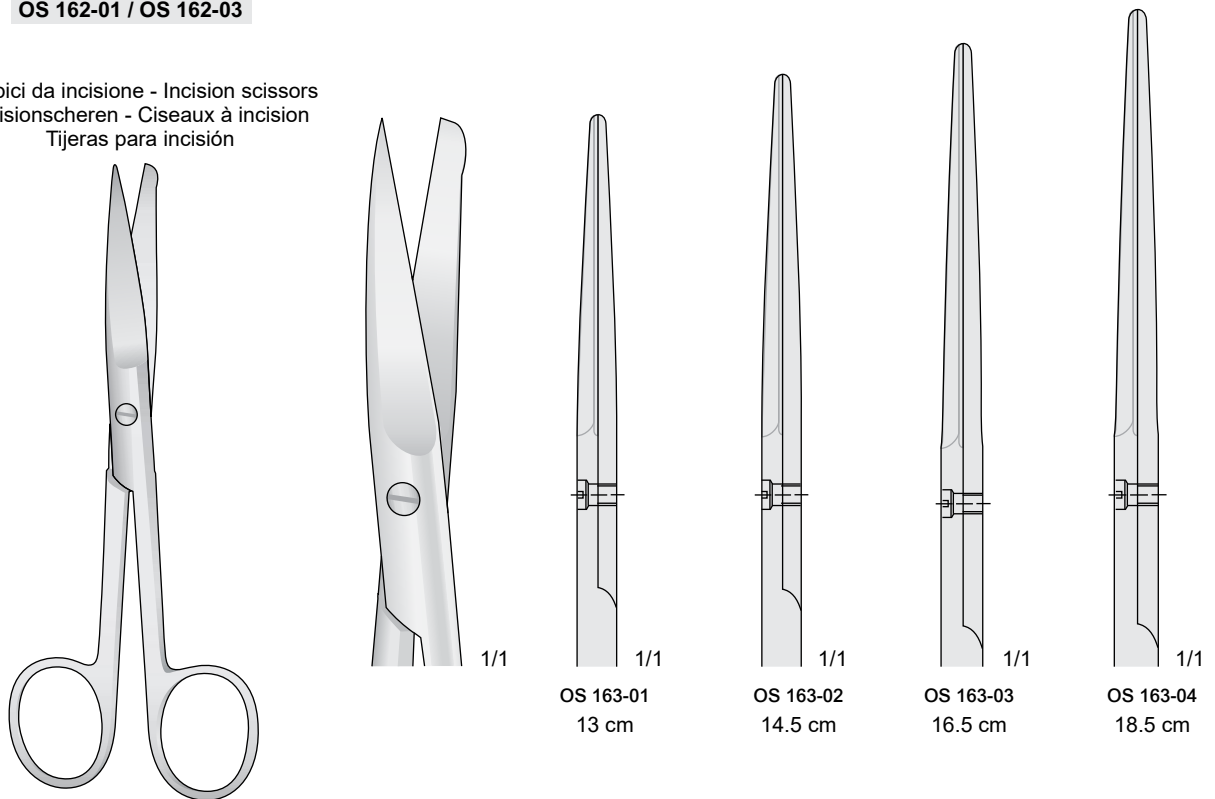

OS 163-01 / OS 163-04

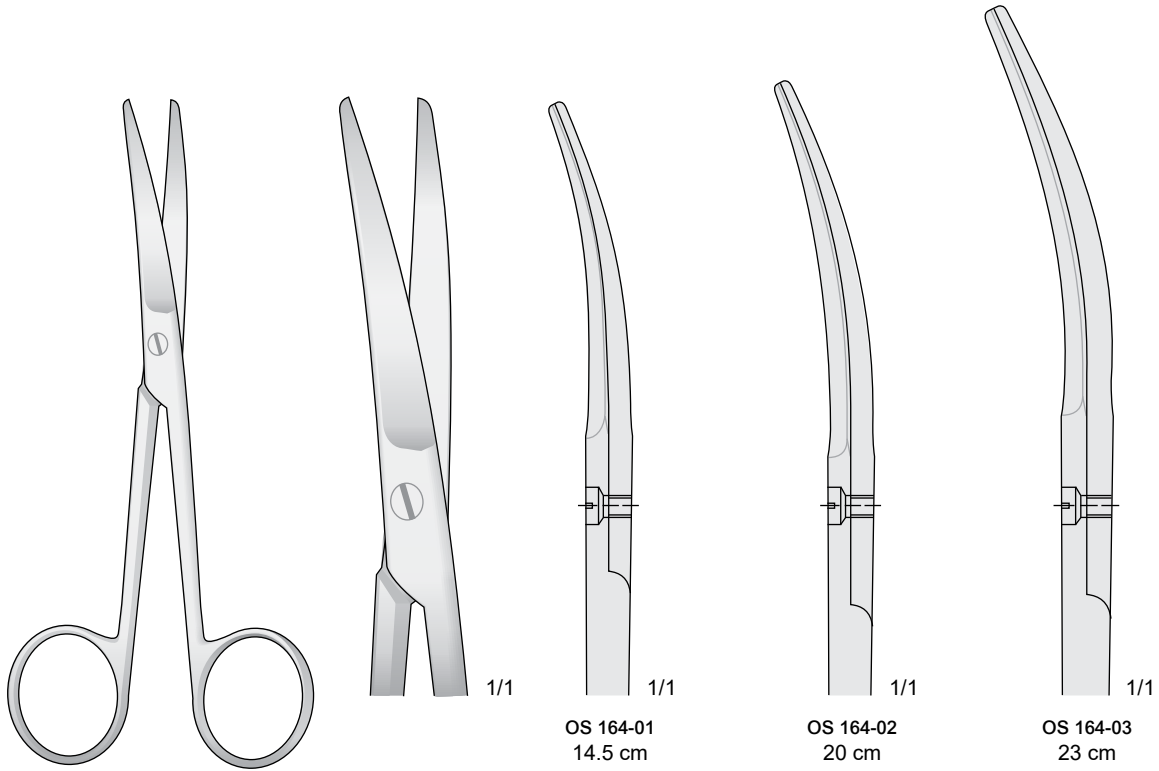

WERTHEIM

OS 164-01 / OS 164-03

OS 164-01
14.5 cm

OS 164-02
20 cm

OS 164-03
23 cm

Con una lama dentellata
With one blade serrated
Mit eine Schneide gezahnt
Avec lame dentèle
Con una hoja dentada

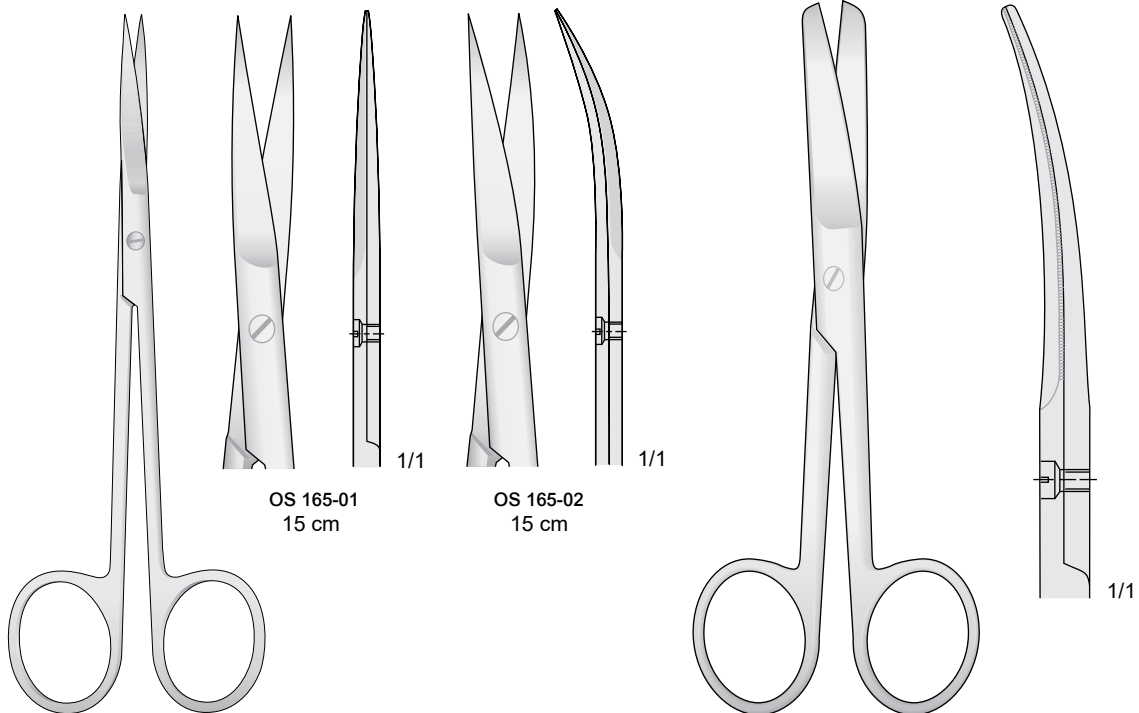

JOSEPH

OS 165-01 / OS 165-02

OS 165-01
15 cm

OS 165-02
15 cm

OS 166-16 16.5 cm

Forbici delicate
 Delicate scissors
 Feine Scheren
 Ciseaux délicate
 Tijeras finas

Con occhiello per sutura - With eye for suture
 Mit faden bohrung - Avec oeil pour les sutures
 Tijeras para ligaduras

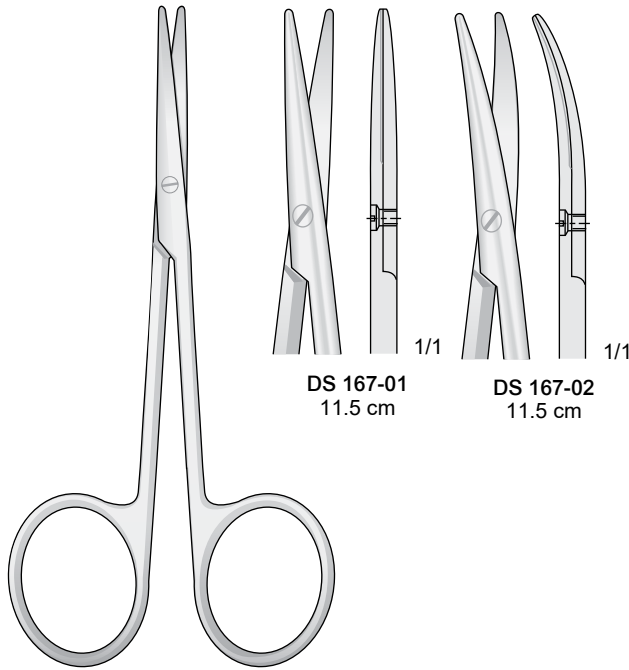

DS 167-01
11.5 cm

DS 167-02
11.5 cm

BABY - METZENBAUM
DS 167-01 / DS 167-02

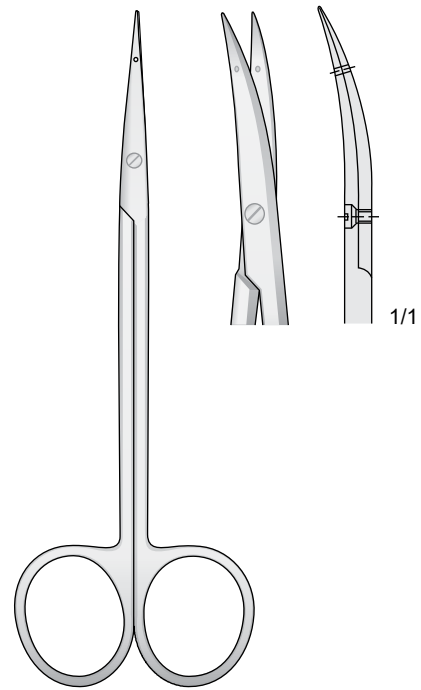

LITTLER

DS 168-12 12 cm

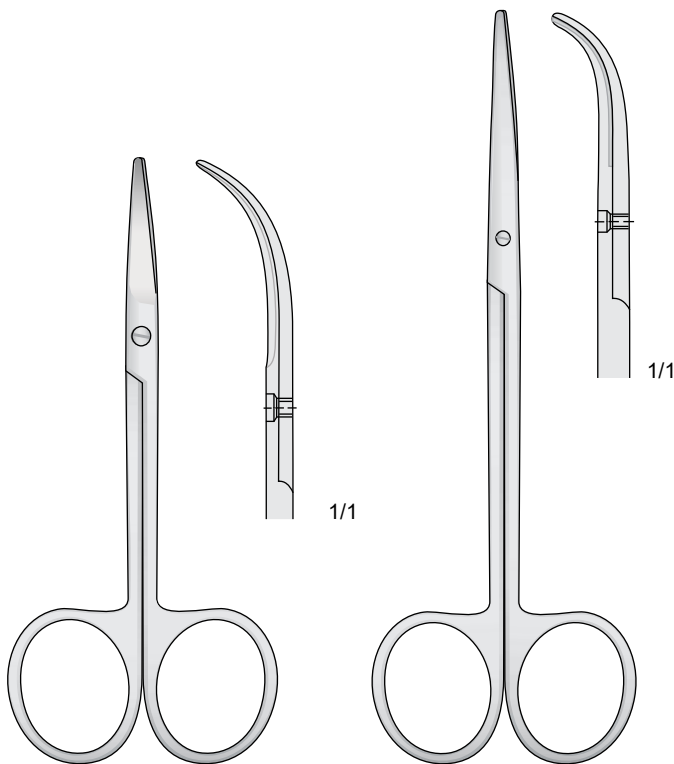

FOMON
DS 169-11 11 cm

DS 170-14 14 cm

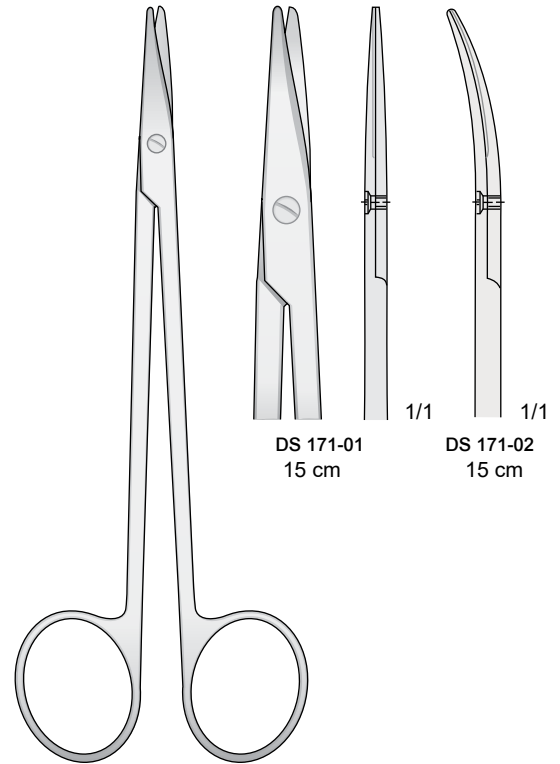

DS 171-01
15 cm

DS 171-02
15 cm

METZENBAUM
DS 171-01 / DS 171-02

Forbici per dissezione - Dissecting Scissors
Präparierscheren - Ciseaux à dissection - Tijeras para preparaciones

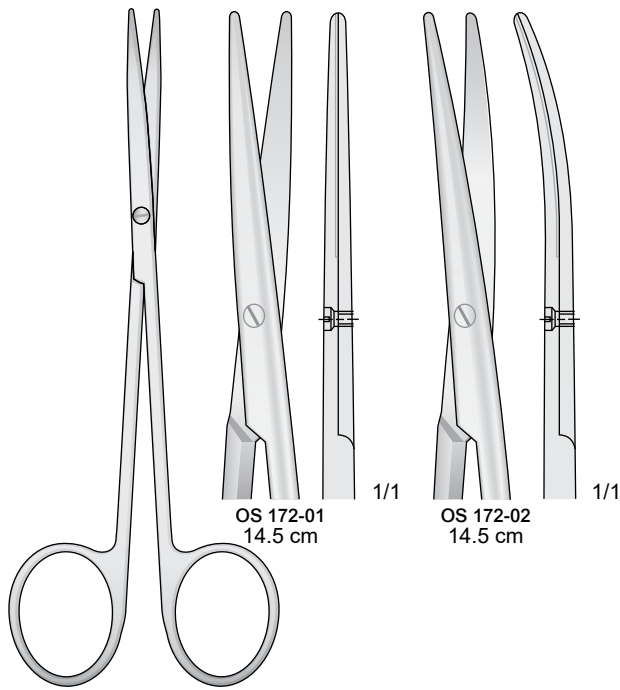

OS 172-01
14.5 cm

OS 172-02
14.5 cm

METZENBAUM
OS 172-01 / OS 172-02

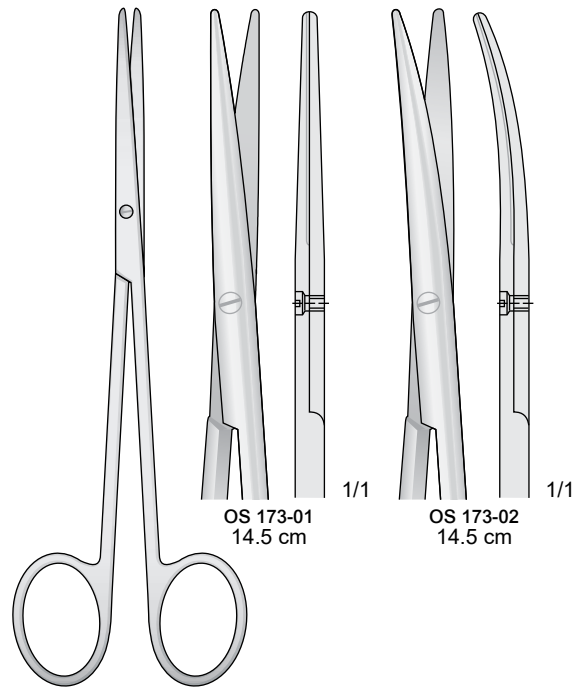

OS 173-01
14.5 cm

OS 173-02
14.5 cm

METZENBAUM-FINE
OS 173-01 / OS 173-02

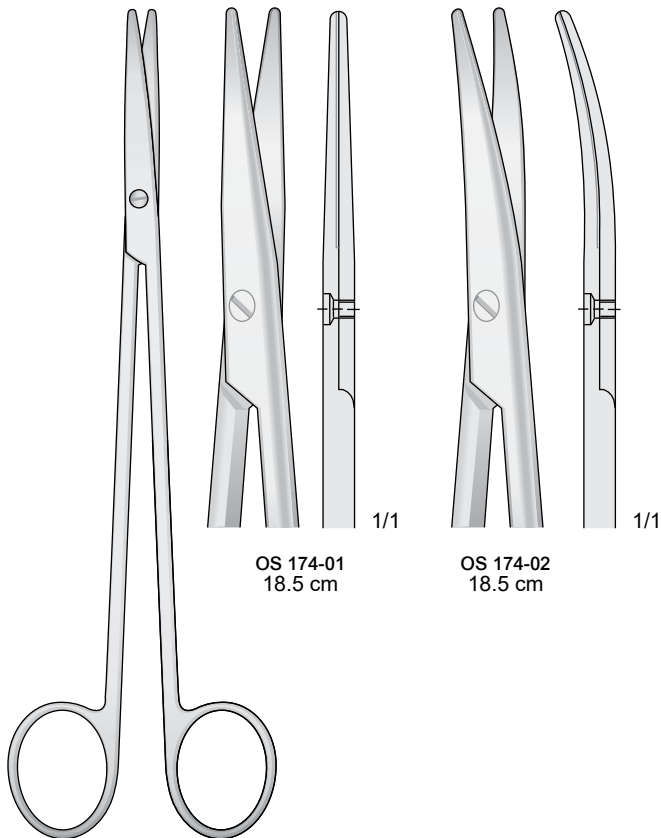

OS 174-01
18.5 cm

OS 174-02
18.5 cm

METZENBAUM
OS 174-01 / OS 174-02

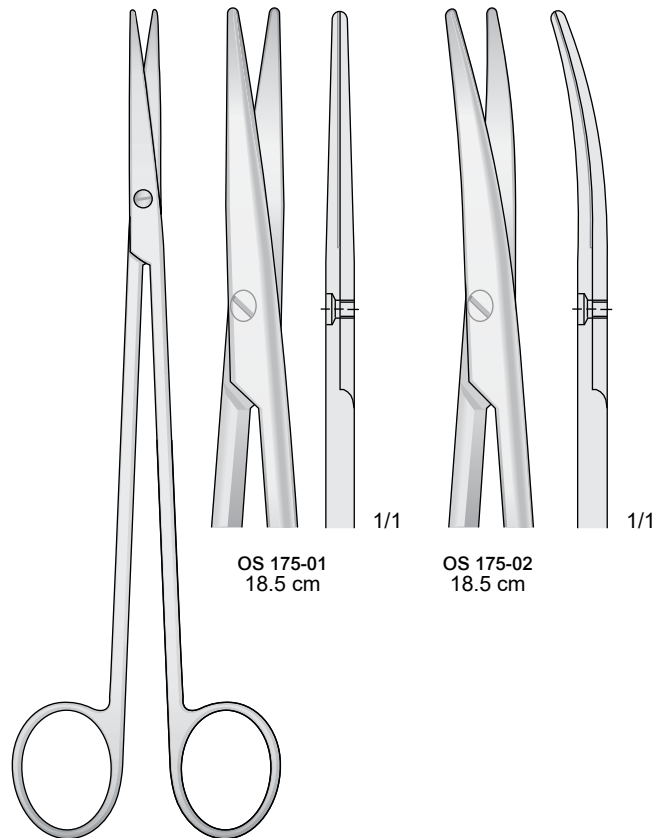

OS 175-01
18.5 cm

OS 175-02
18.5 cm

METZENBAUM-FINE
OS 175-01 / OS 175-02

Forbici per dissezione - Dissecting Scissors
 Präparierscheren - Ciseaux à dissection - Tijeras para preparaciones

Acuta - Sharp
 Spitz - Aigu - Agudo

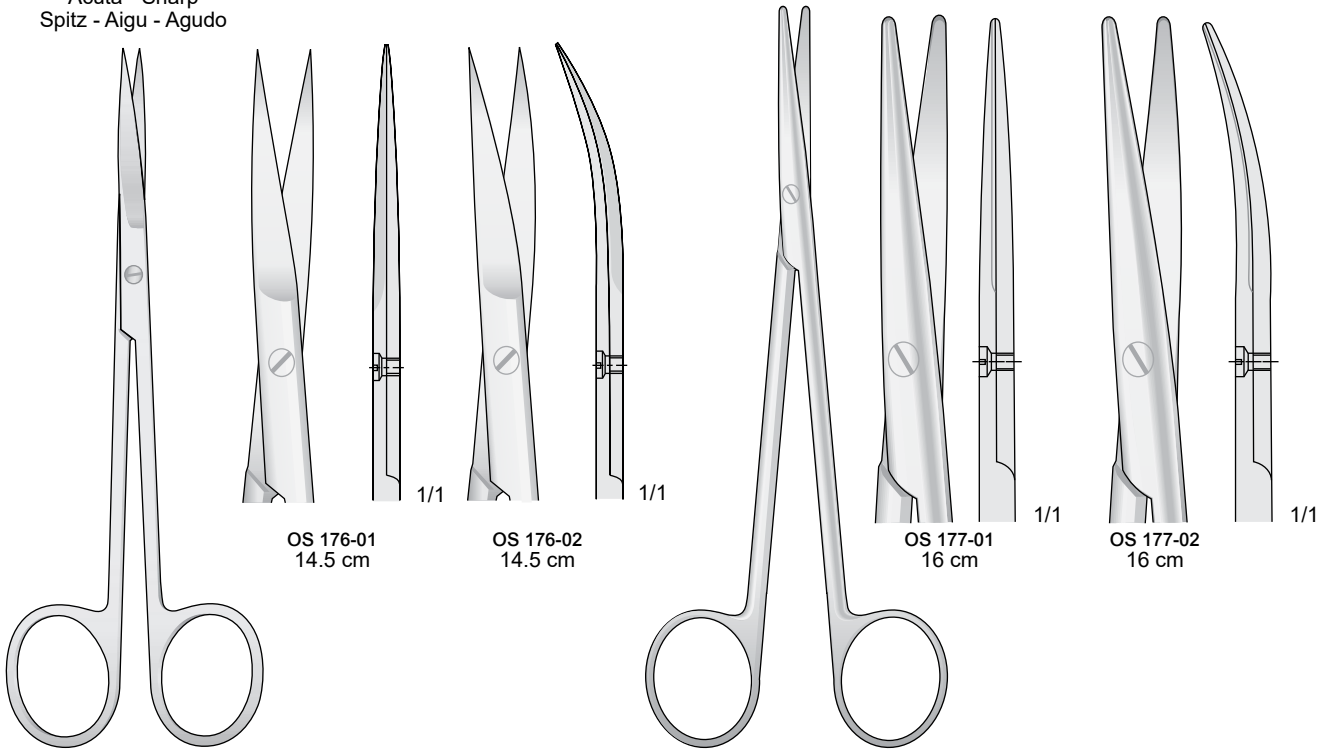

METZENBAUM
OS 176-01 / OS 176-02

METZENBAUM
OS 177-01 / OS 177-02

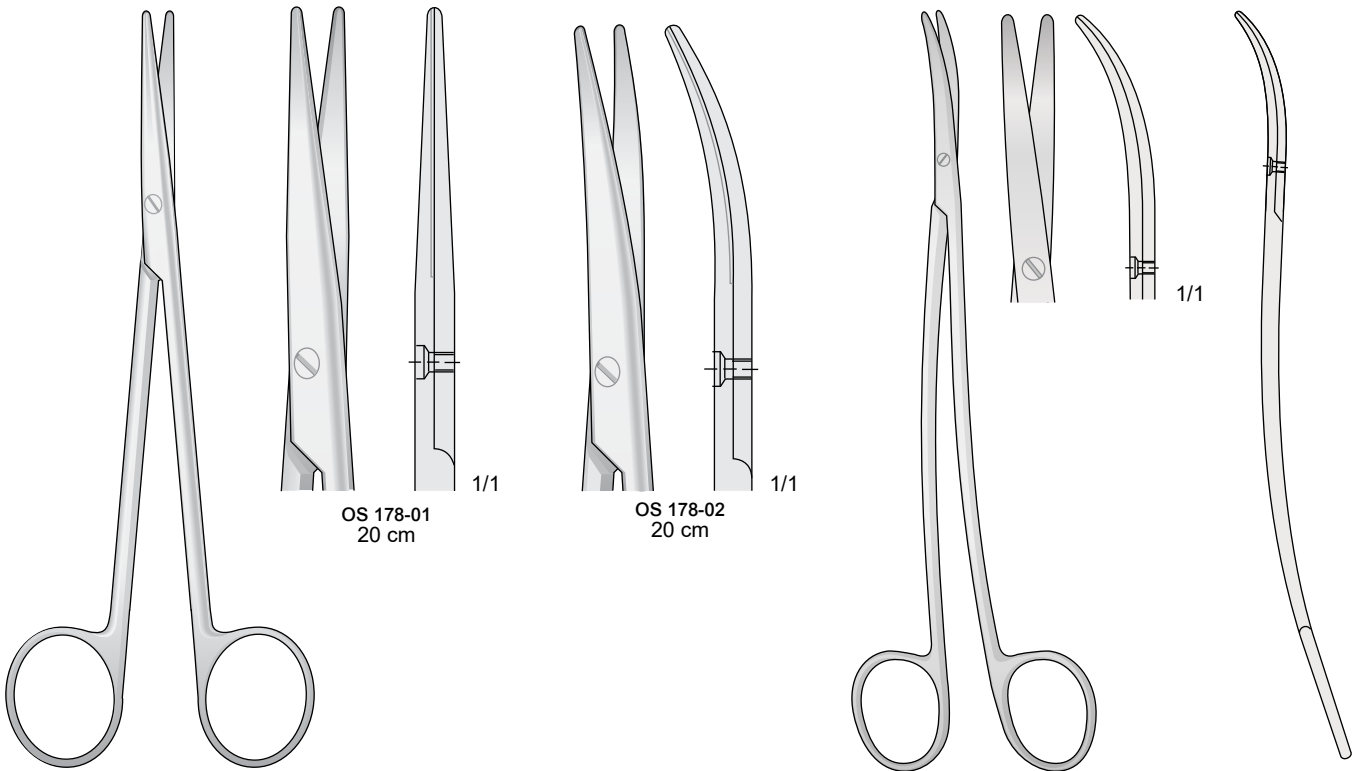

METZENBAUM
OS 178-01 / OS 178-02

METZENBAUM-FINO
OS 179-18 18 cm
OS 179-20 20 cm
OS 179-23 23 cm

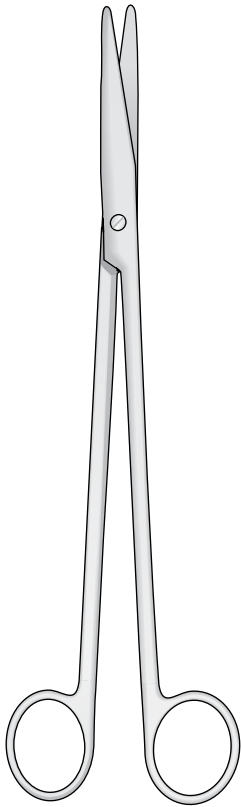

NELSON-METZENBAUM
OS 180-01 / OS 180-04

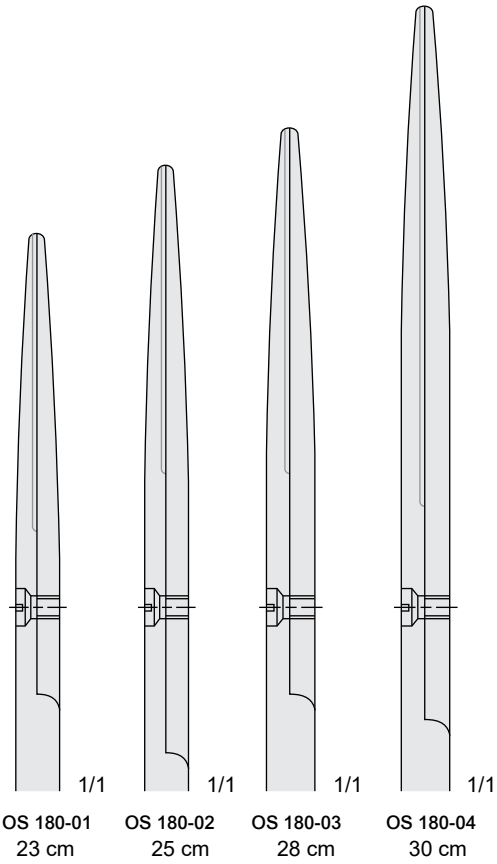
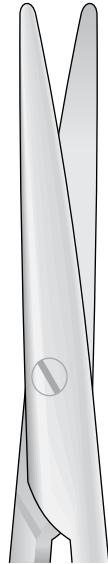

OS 180-01 23 cm OS 180-02 25 cm OS 180-03 28 cm OS 180-04 30 cm

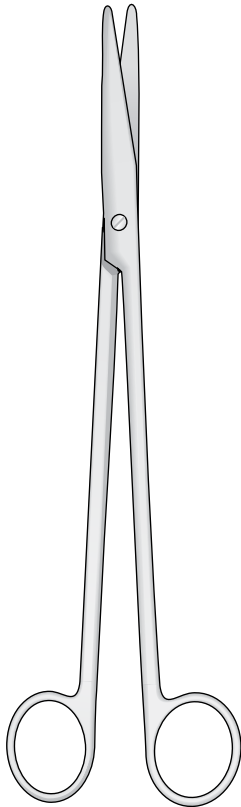

NELSON-METZENBAUM
OS 181-01 / OS 181-04

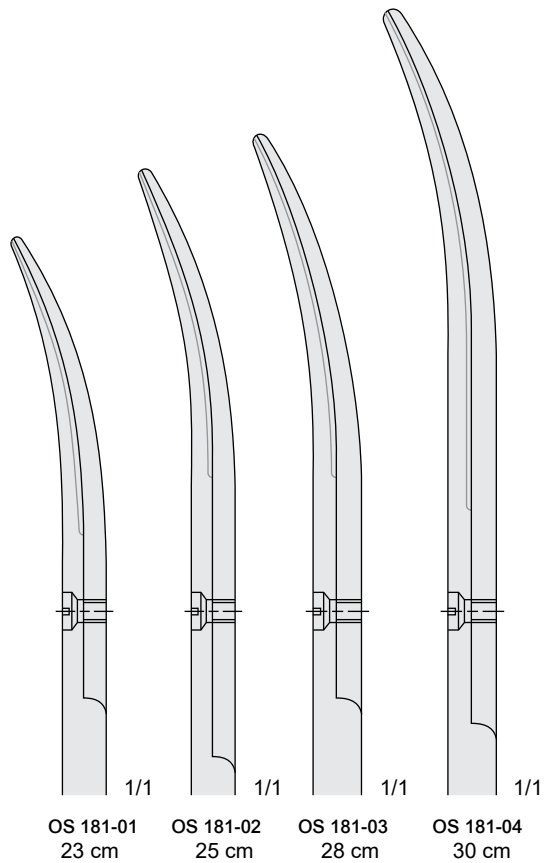
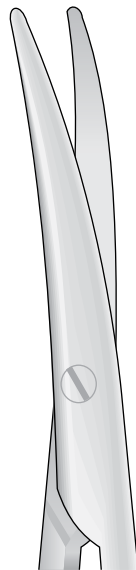

OS 181-01 23 cm OS 181-02 25 cm OS 181-03 28 cm OS 181-04 30 cm

Fine - Delicate - Fein - Fins - Finas

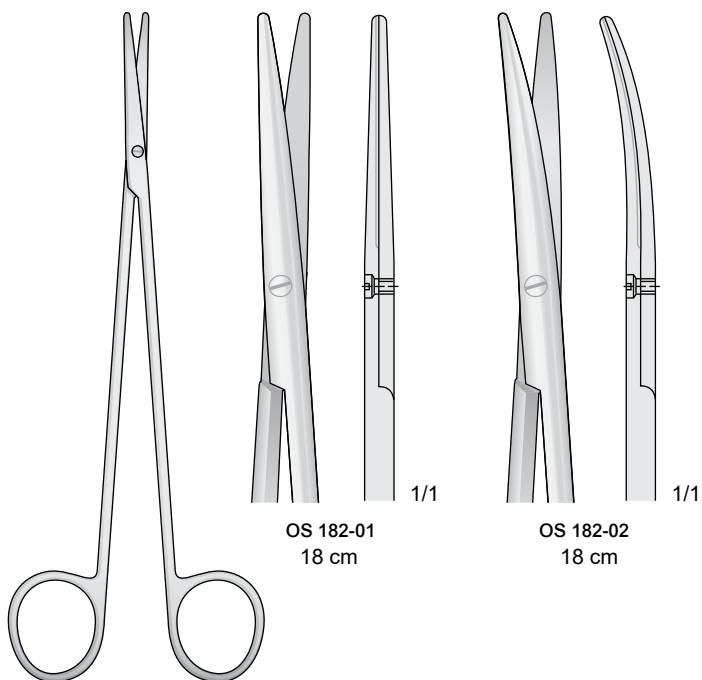

TOENNIS-ADSON
OS 182-01 / OS 182-02

Fine - Delicate - Fein - Fins - Finas

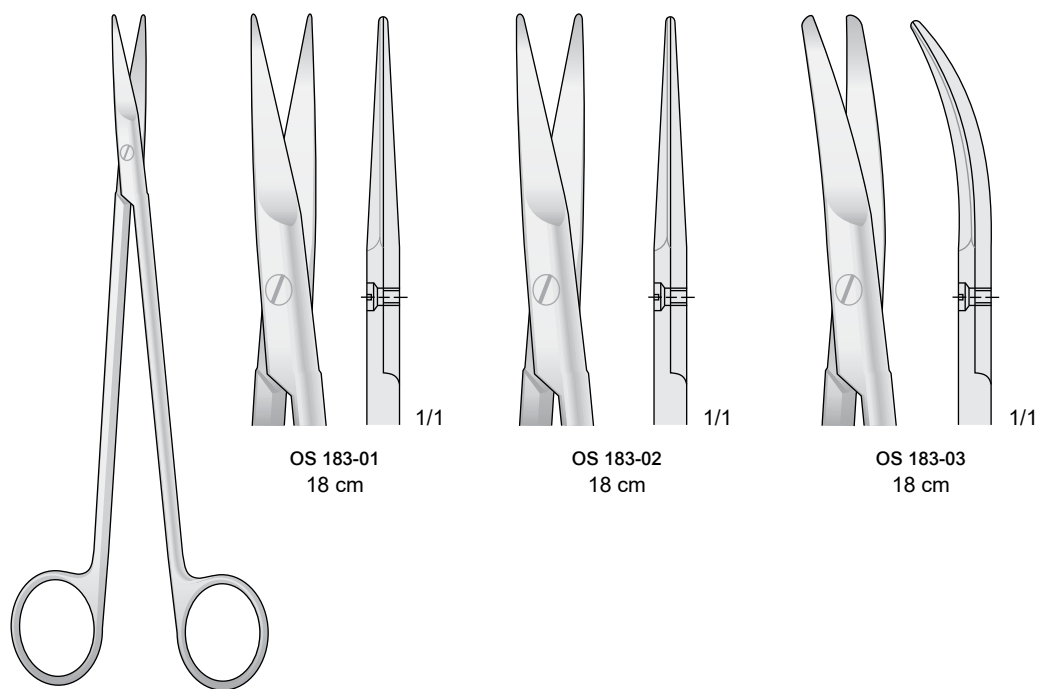

TOENNIS
OS 183-01 / OS 183-03

Forbici per dissezione - Dissecting scissors - Präparierscheren - Ciseaux à dissection - Tijeras para preparaciones

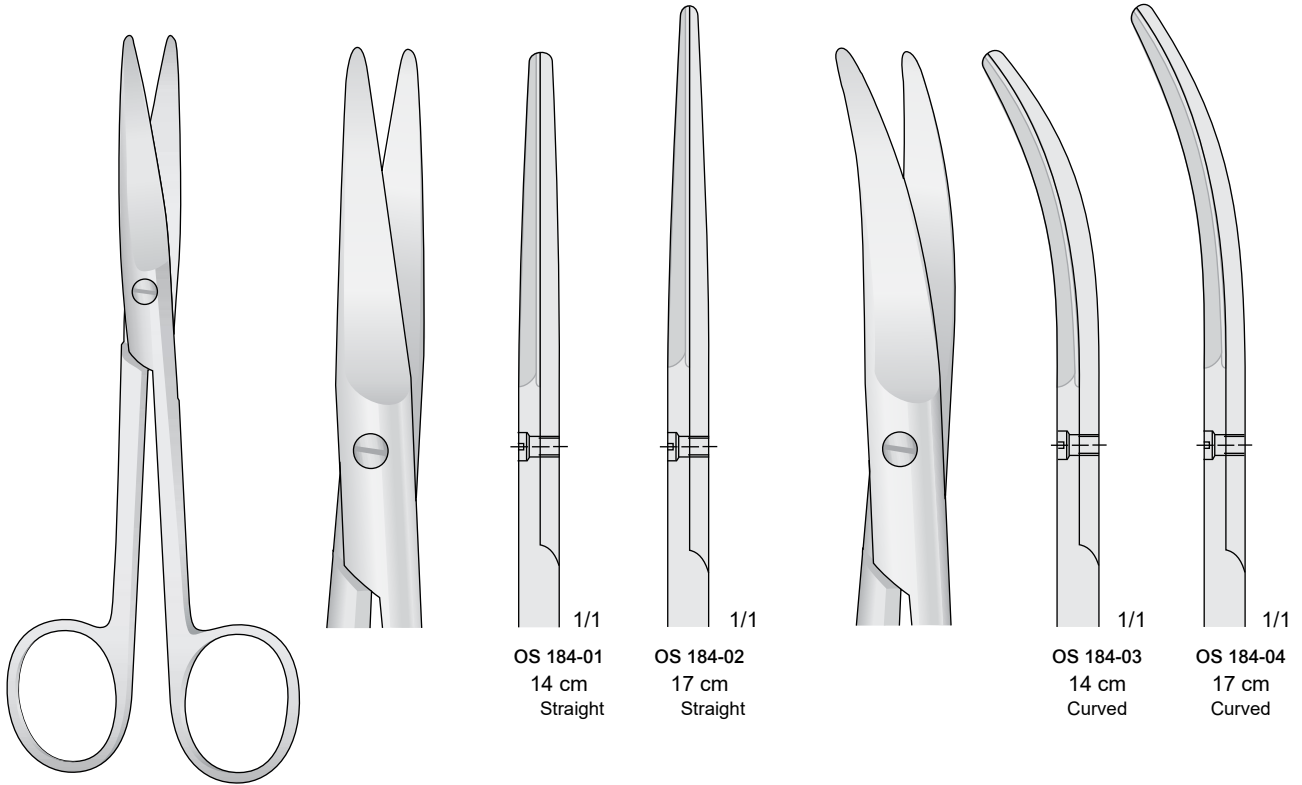

MAYO

OS 184-01 / OS 184-04

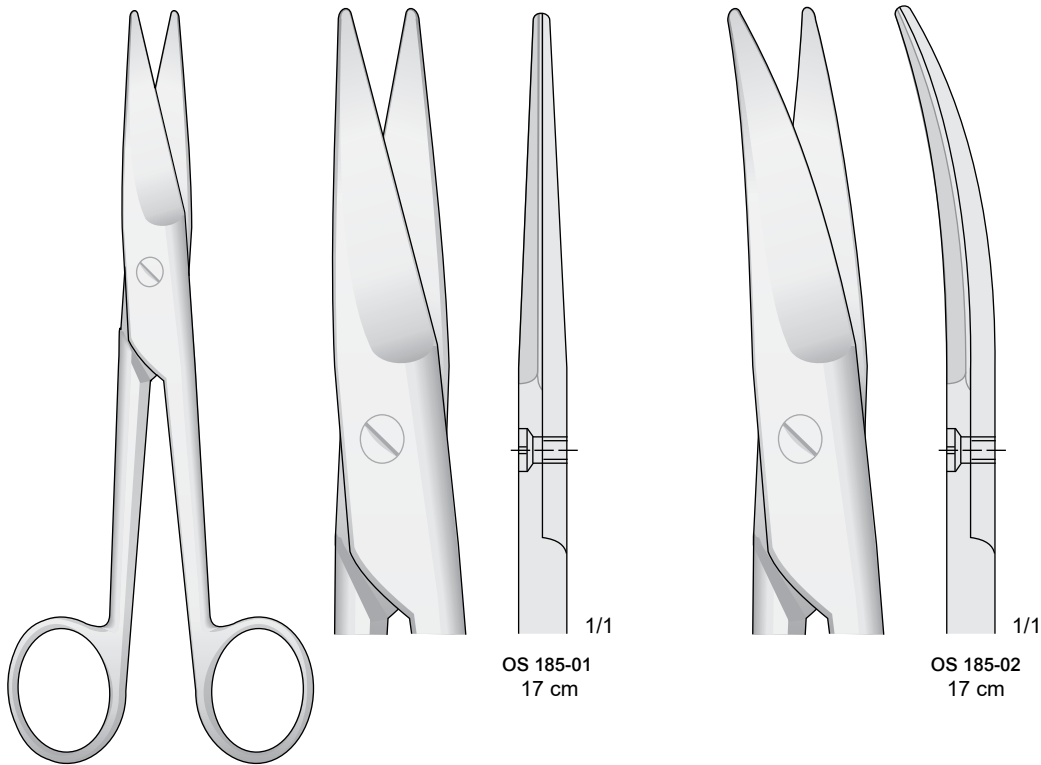

MAYO-NOBLE

OS 185-01 / OS 185-02

Forbici chirurgich
Operating scissor
Chirurgische Schere
Ciseaux chirurgicau
Tijeras para cirugia general

Forbici per dissezione - Dissecting scissors - Präparierscheren - Ciseaux à dissection - Tijeras para preparaciones

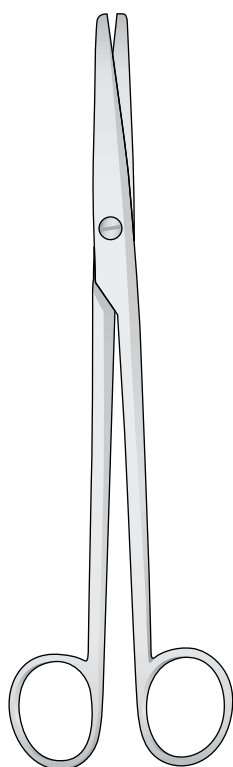

MAYO

OS 186-01 / OS 186-03

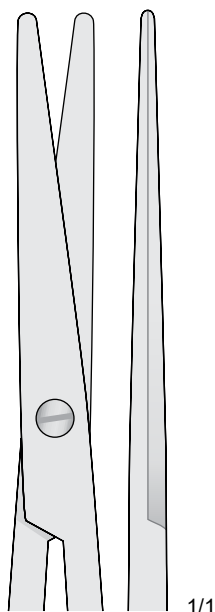

OS 186-01
16 cm

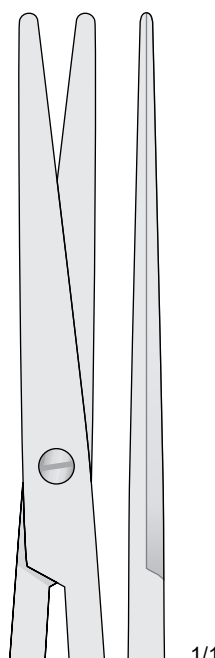

OS 186-02
19 cm

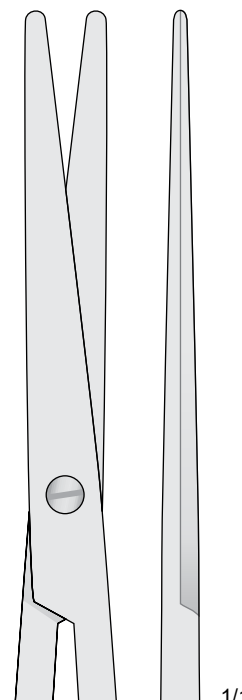

OS 186-03
21 cm

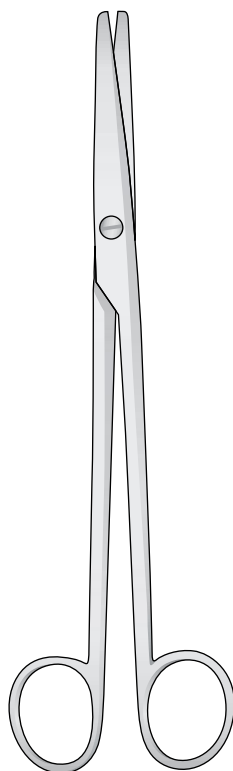

MAYO

OS 187-01 / OS 187-03

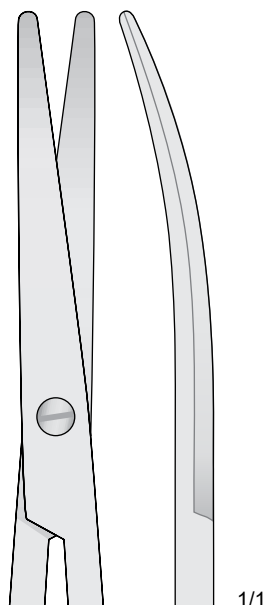

OS 187-01
16 cm

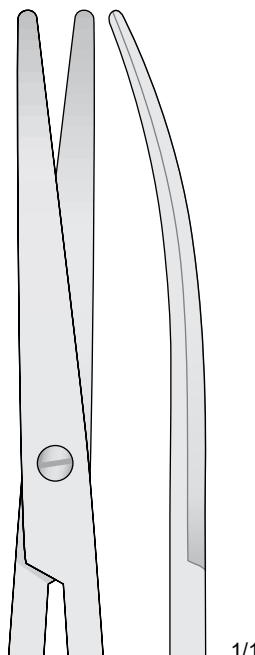

OS 187-02
19 cm

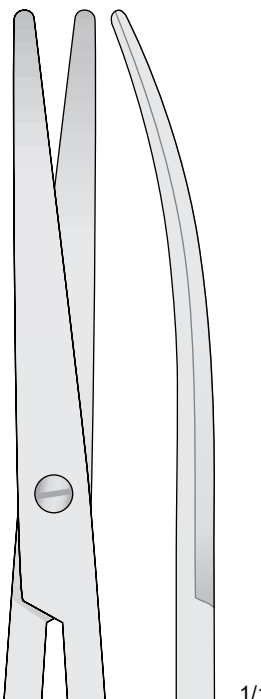

OS 187-03
21 cm

Fine - Delicate - Fein - Fins - Finas

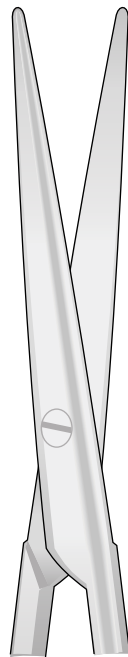
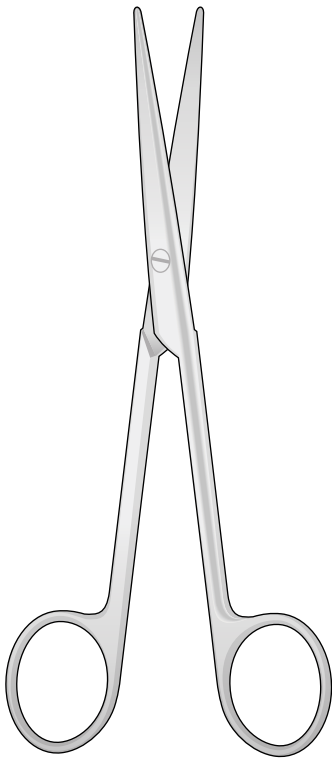

OS 188-01
18 cm

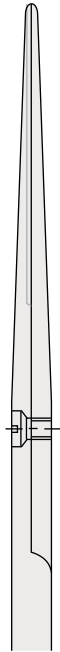

1/1

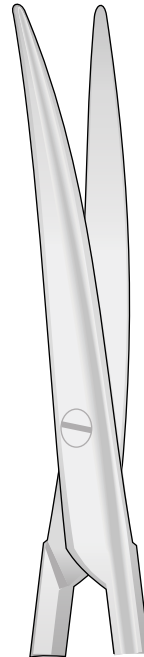

OS 188-02
18 cm

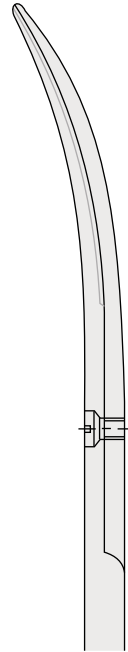

1/1

LEXER

OS 188-01 / OS 188-02

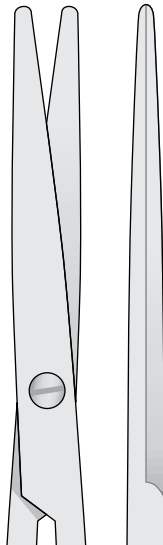
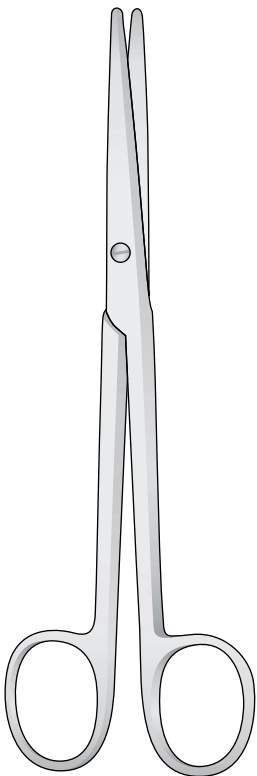

OS 189-01
16 cm
Straight

1/1

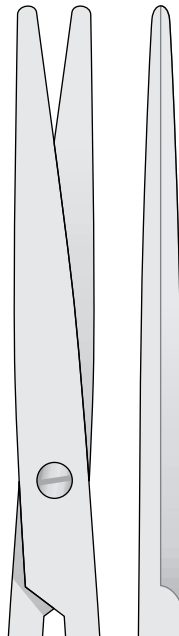

OS 189-02
21 cm
Straight

1/1

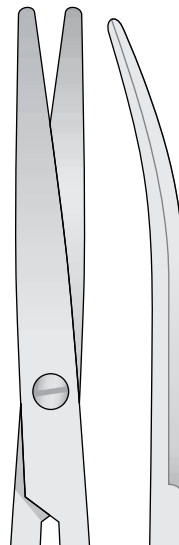

OS 189-03
16 cm
Curved

1/1

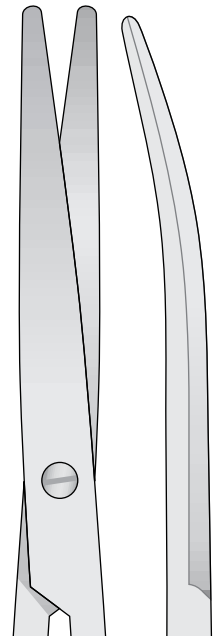

OS 189-04
21 cm
Curved

1/1

LEXER

OS 189-01 / OS 199-04

Forbici per dissezione - Dissecting Scissors - Präparierscheren - Ciseaux à dissection - Tijeras para preparaciones

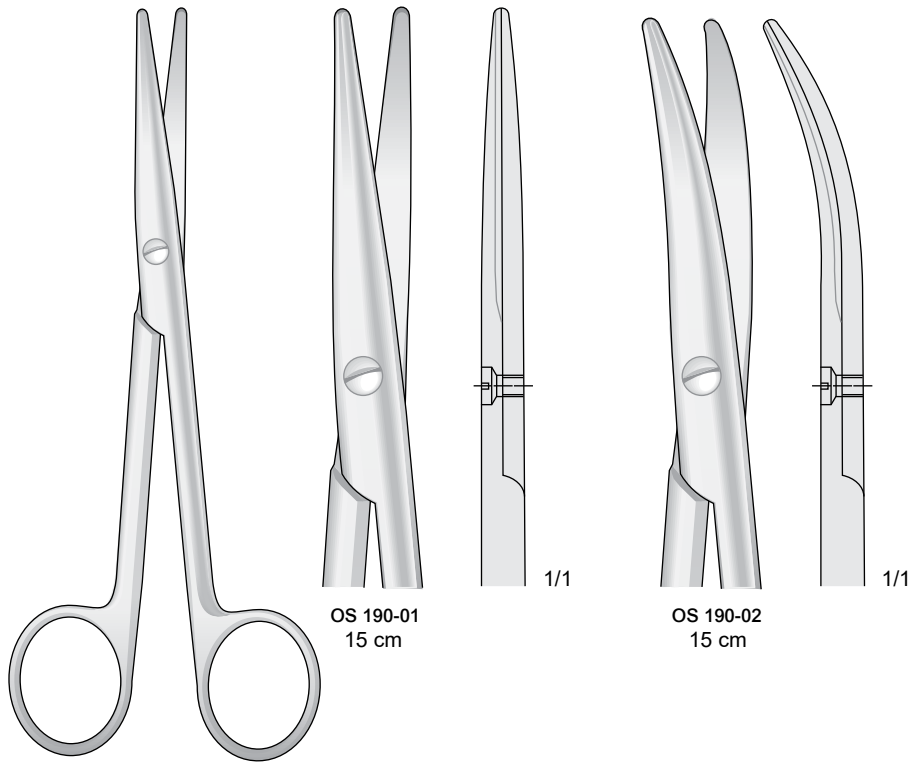

OS 190-01
15 cm

OS 190-02
15 cm

STILLE
OS 190-01 / OS 190-2

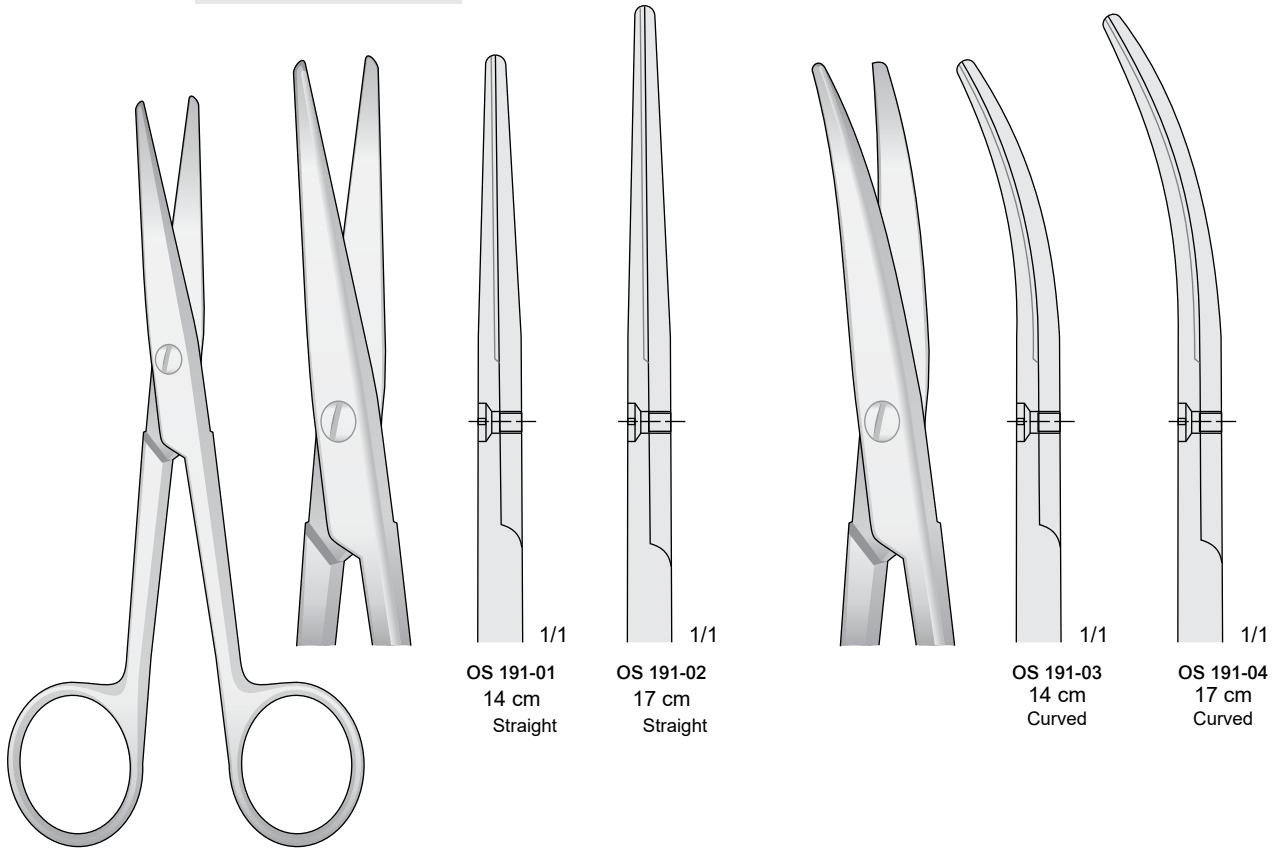

OS 191-01
14 cm
Straight

OS 191-02
17 cm
Straight

OS 191-03
14 cm
Curved

OS 191-04
17 cm
Curved

MAYO-STILLE
OS 191-01 / OS 191-04

Forbici per dissezione a taglio bilaterale - Bilateral Dissecting Scissors
Präparierscheren - Ciseaux à dissection - Tijeras para preparaciones

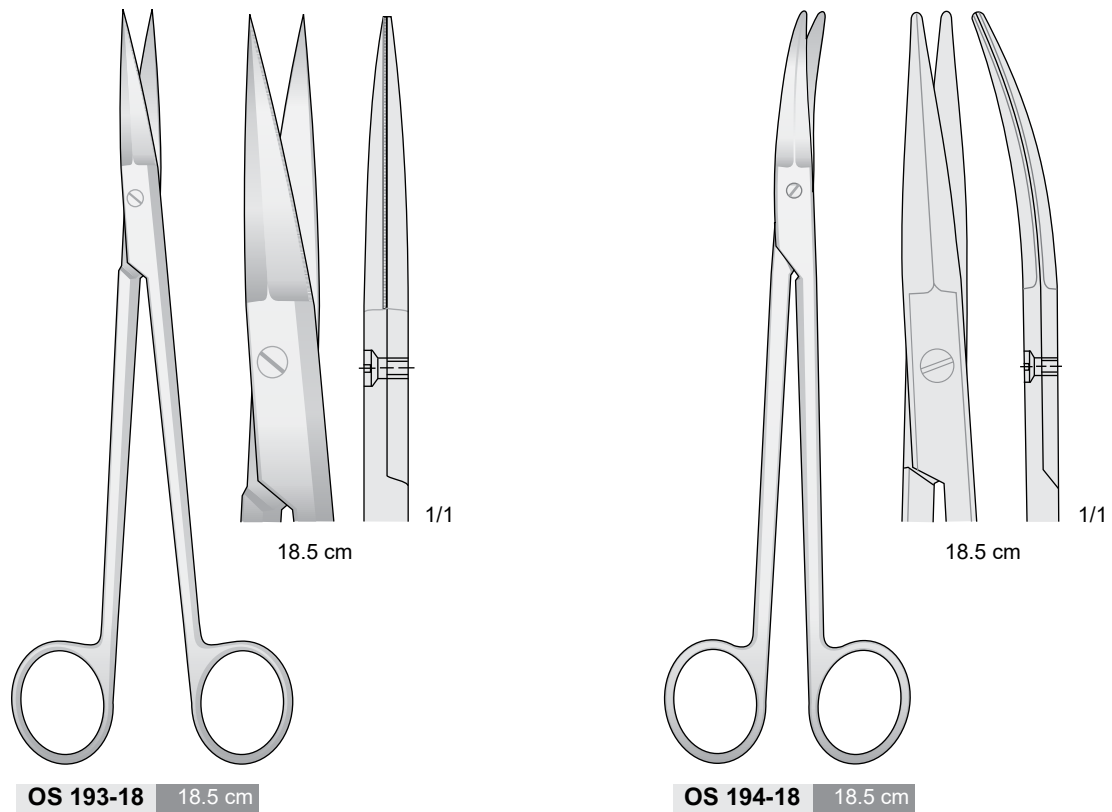
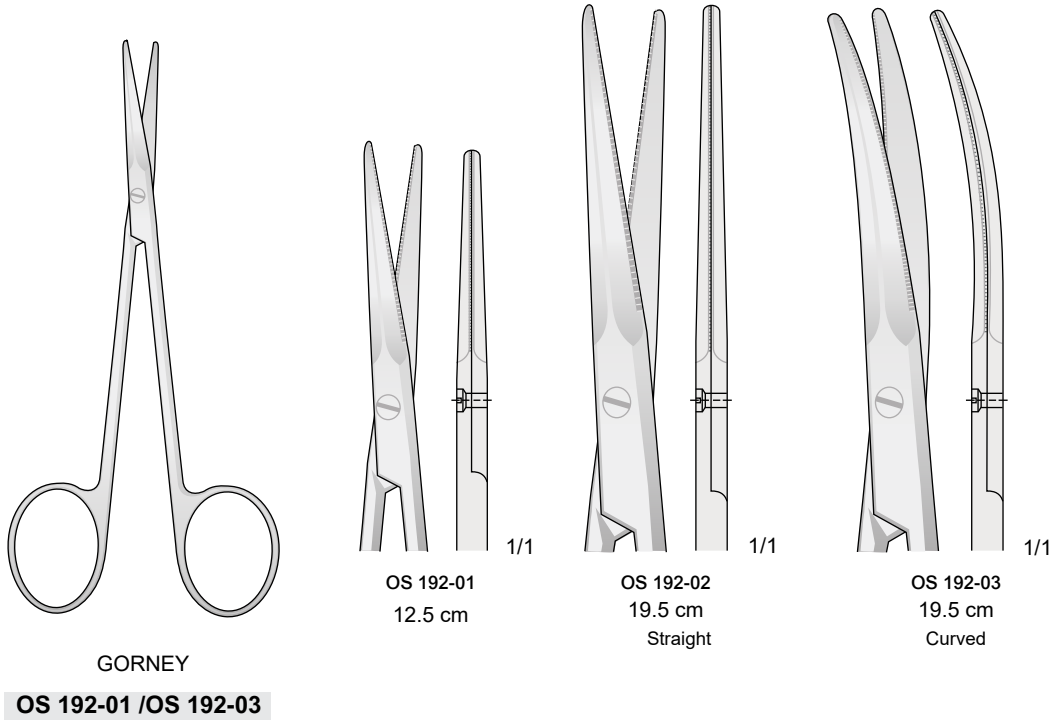

Forbici chirurgich
 Operating scissor
 Chirurgische Schere
 Ciseaux chirurgicau
 Tijeras para cirugia general

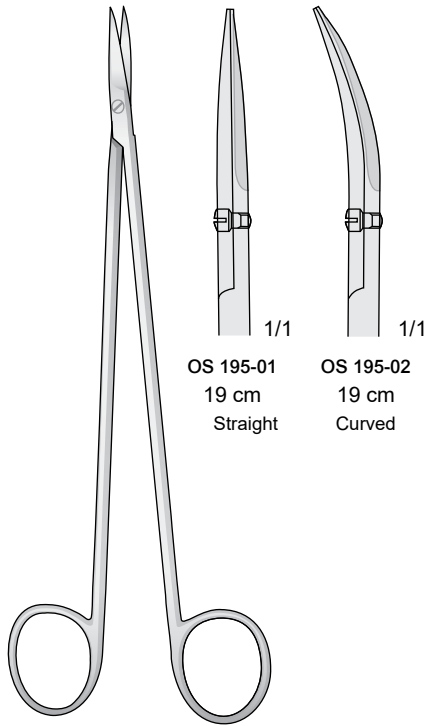

OS 195-01 / OS 195-02

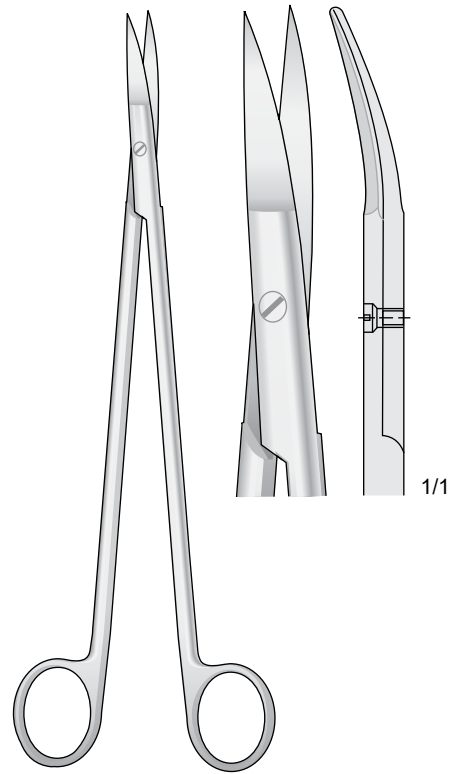

OS 196-22 22 cm

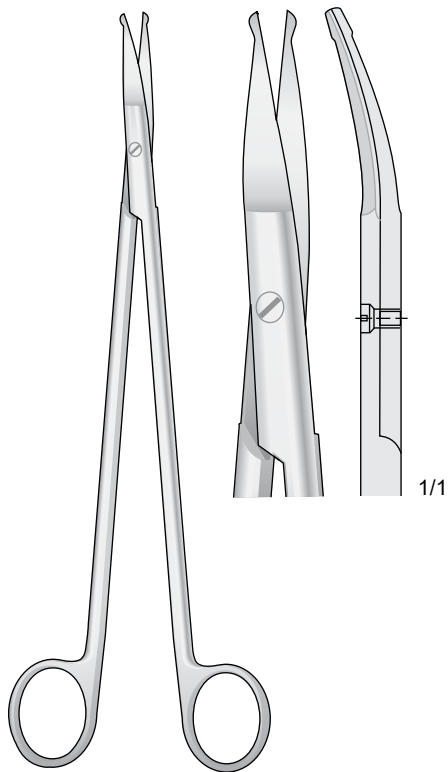

OS 197-22 22 cm

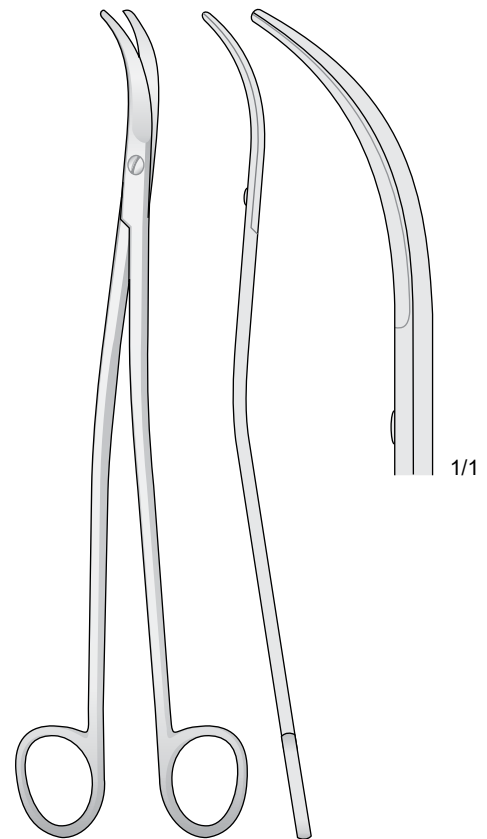

OS 198-24 24.5 cm



Dentellata - Serrated - Gezahnt - Dentelé - Dentadas

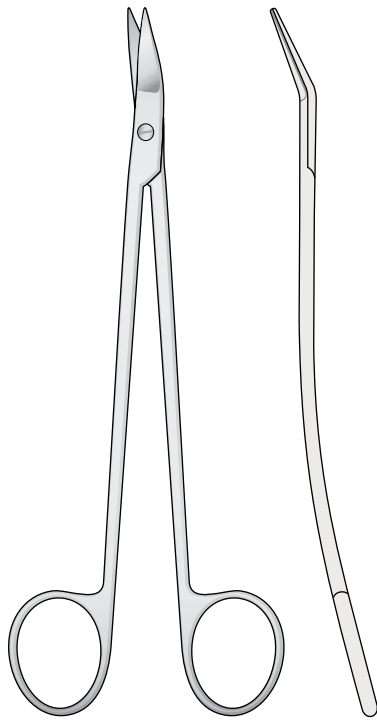

DEAN

OS 199-18 18 cm

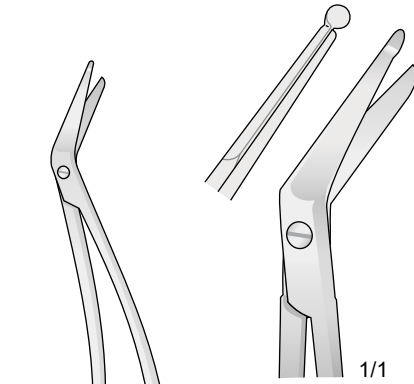
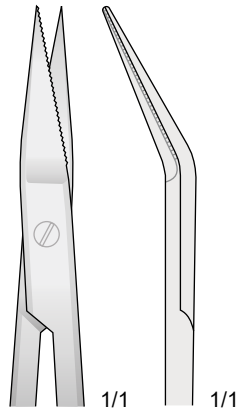

SCHMIEDEN-TAYLOR

OS 200-15 15.5 cm

Dentellata - Serrated - Gezahnt - Dentelé - Dentadas

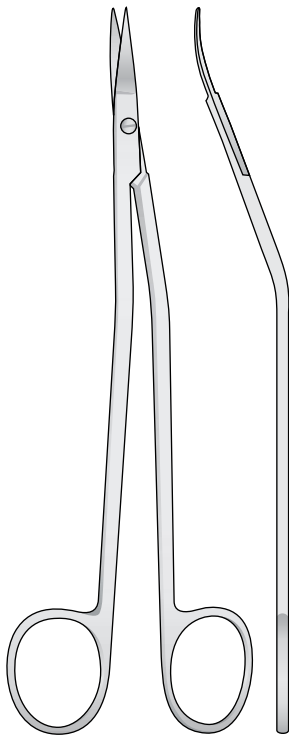

DANDY

OS 201-17 17.5 cm

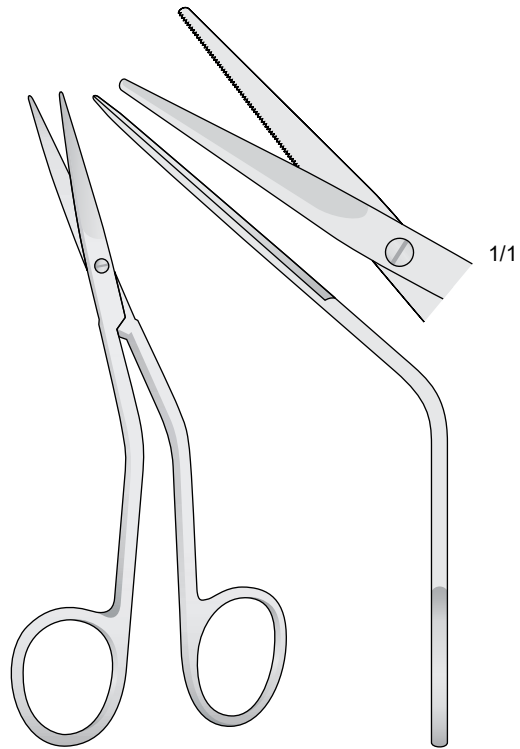

FOMON

OS 202-13 13.5 cm

Forbici nasali - Nasal Scissors - Nasenscheren - Ciseaux nasaux - Tijeras nasales

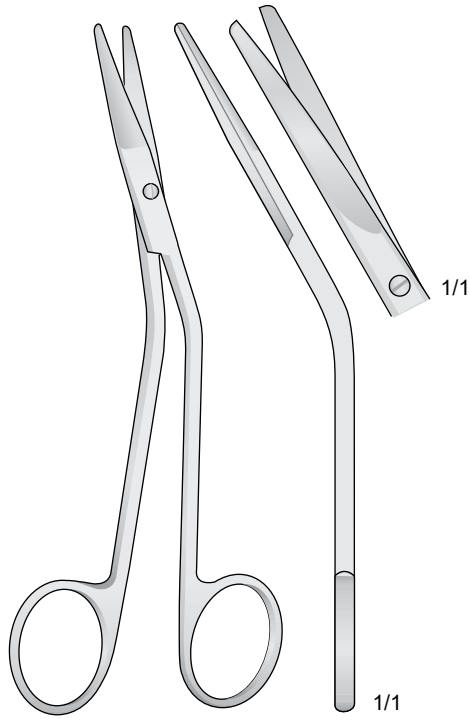

FOMON
OS 203-15 15 cm

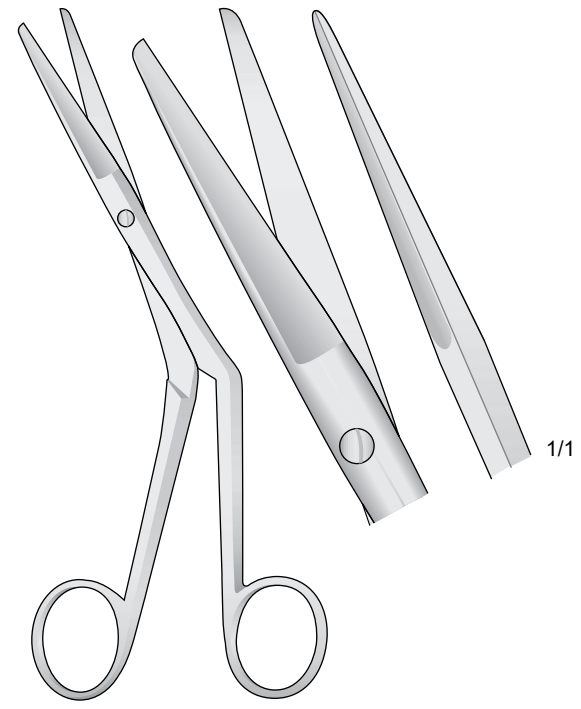

HEYMANN
OS 204-18 18 cm

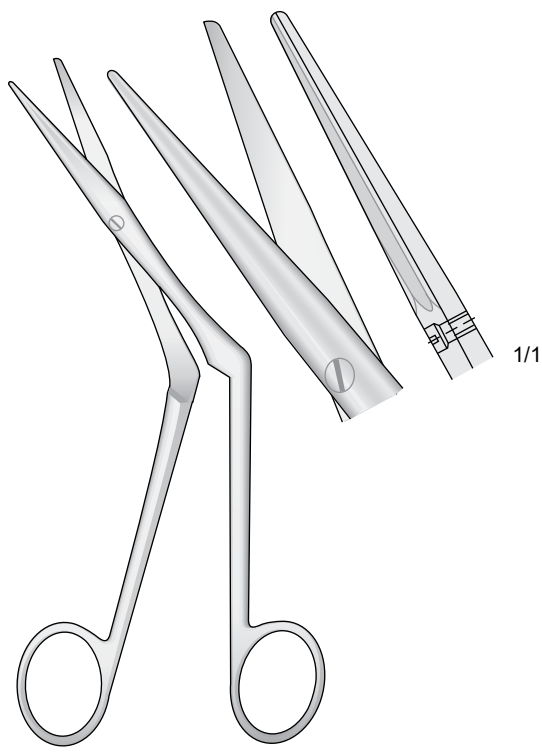

HEYMANN-KNIGHT
OS 205-17 17.5 cm

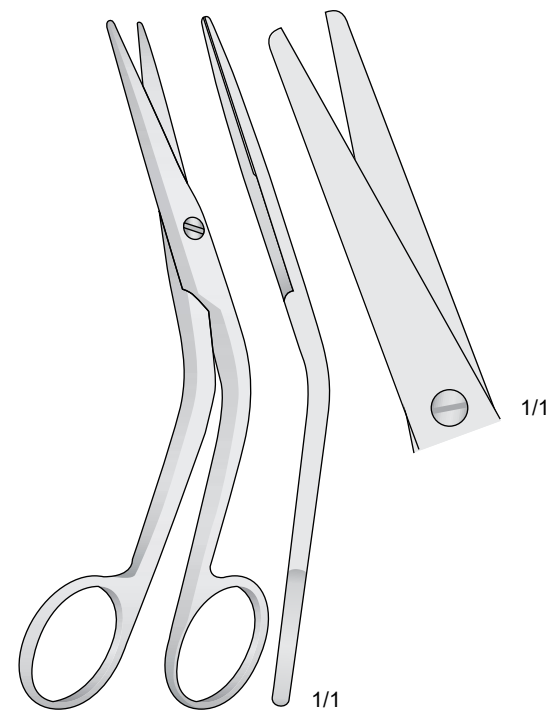

COTTLE
OS 206-16 16 cm

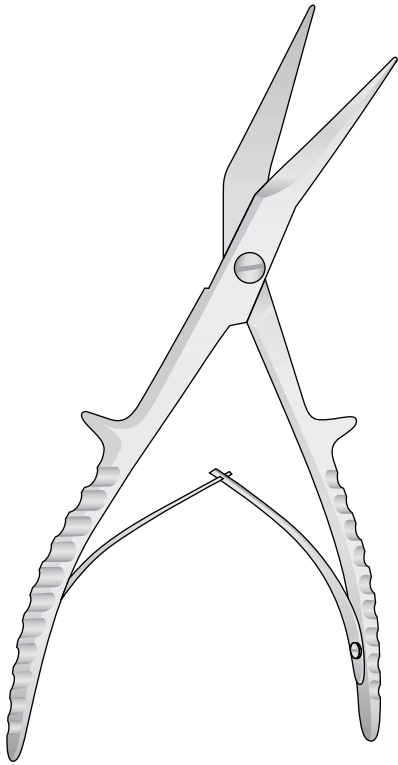

BHF 207-19 19.5 cm

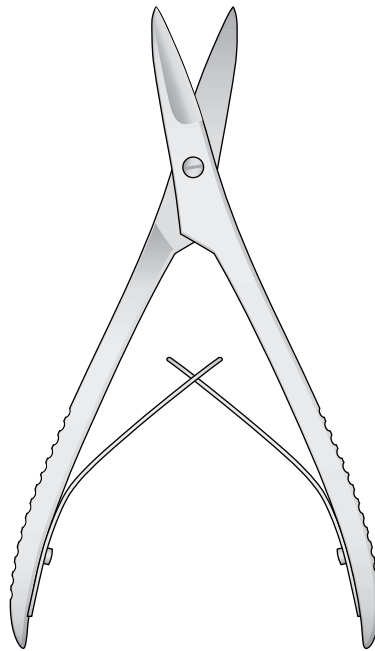

BHF 208-16 16 cm

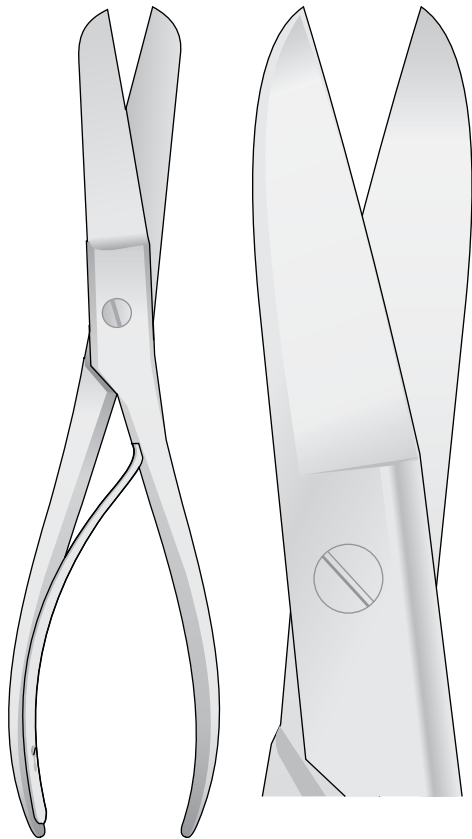
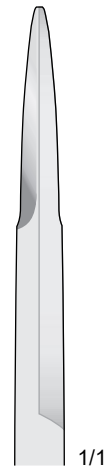

BHF 209-23 23 cm

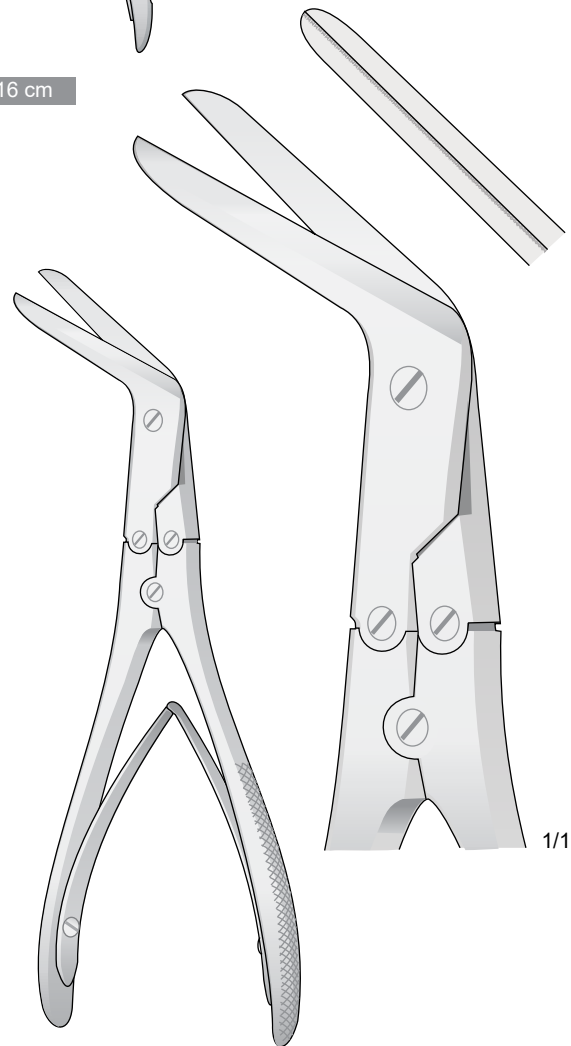
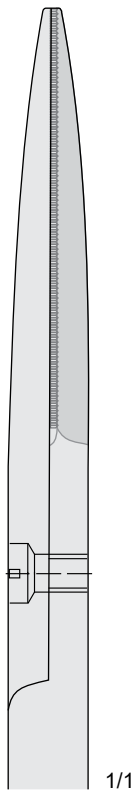

KILLIAN
BHF 210-21 21 cm

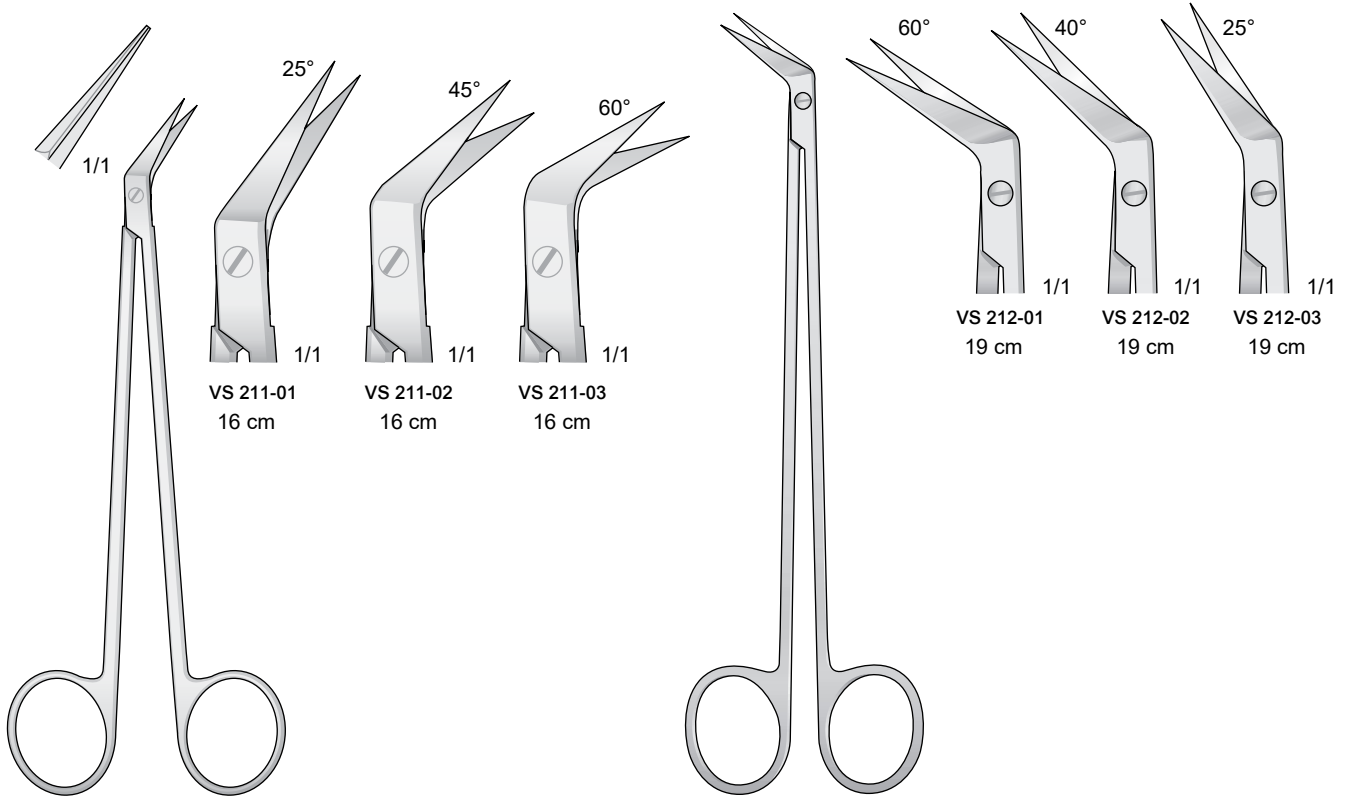

DE BAKEY (POTTS-SMITH)
VS 211-01 / VS 211-03

POTTS-SMITH
VS 212-01 / VS 212-03

Smussa - Blunt - Stumpf
 Mousse - Romas

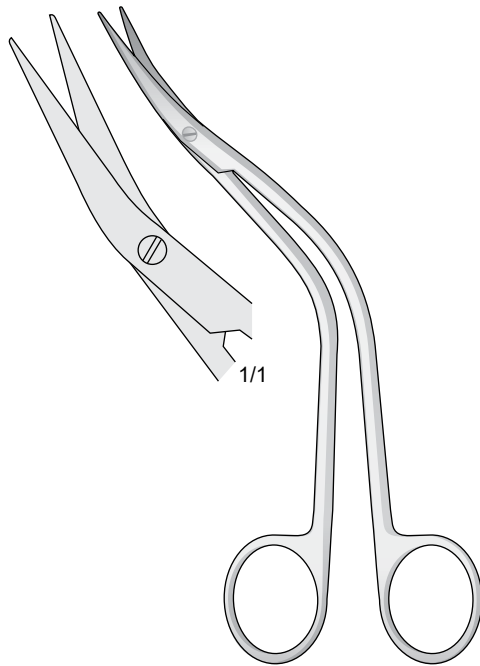

DE BAKEY
VS 213-15 15.5 cm

Acuta - Sharp - Spitz
 Pointu - Agudas

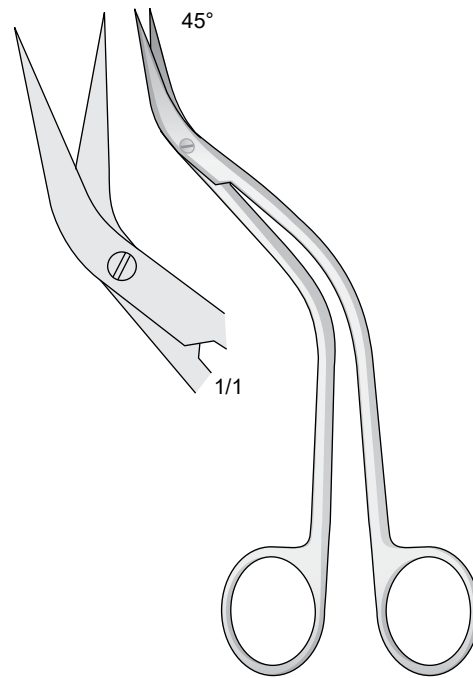

DE BAKEY
VS 214-15 15.5 cm

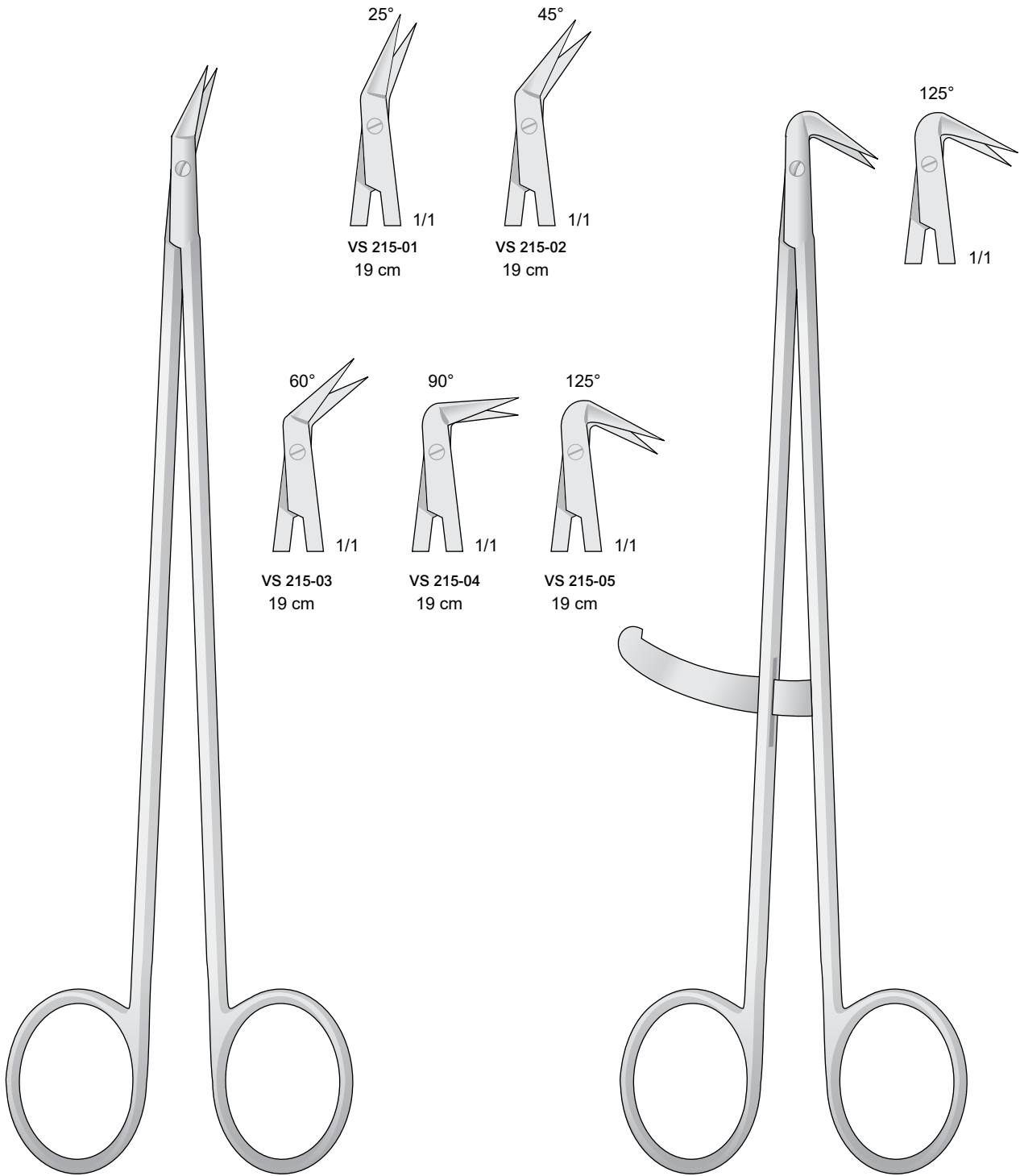

DIETRICH
VS 215-01 / VS 215-05

DIETRICH
VS 216-19 19 cm

Forbici chirurgich
 Operating scissor
 Chirurgische Schere
 Ciseaux chirurgicau
 Tijeras para cirurgia general

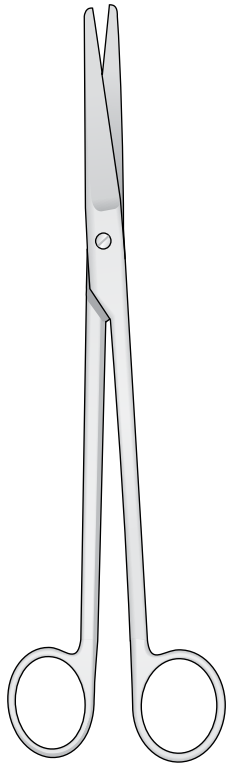

MAYO-HARRINGTON
OS 217-01 / OS 217-02

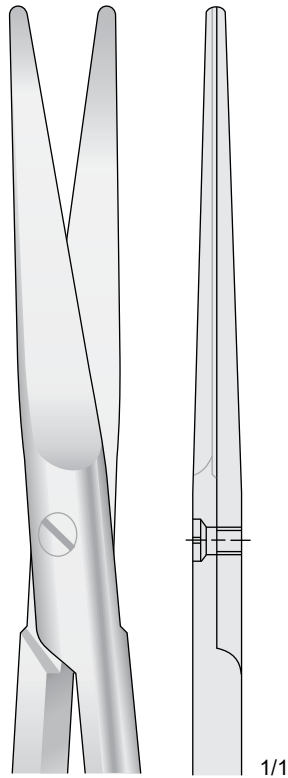

OS 217-01
 23 cm
 Straight

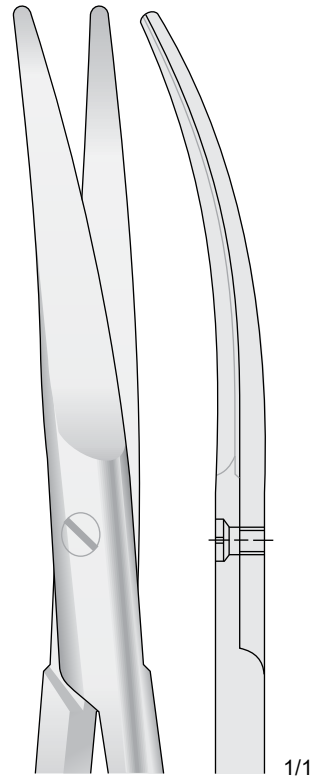

OS 217-02
 23 cm
 Curved

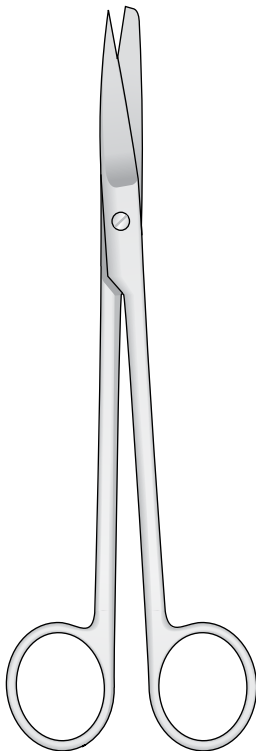

SIMS
OS 218-01 / OS 218-04

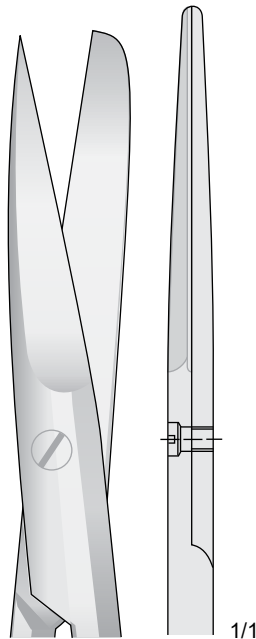

OS 218-01
 20 cm
 Straight

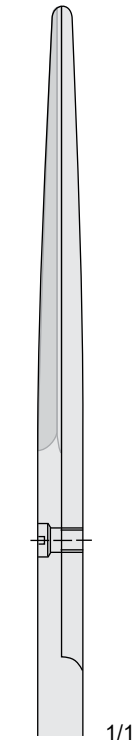

OS 218-02
 23 cm
 Straight

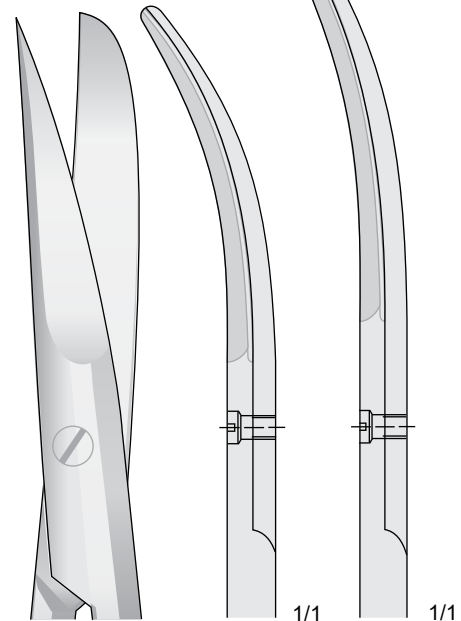

OS 218-03
 20 cm
 Curved

OS 218-04
 23 cm
 Curved

Punte smusse

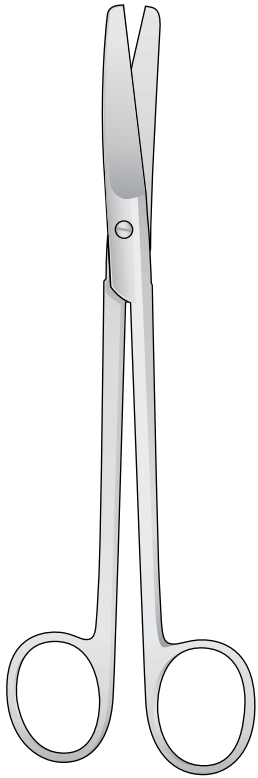

SIMS

OS 219-01 / OS 219-04

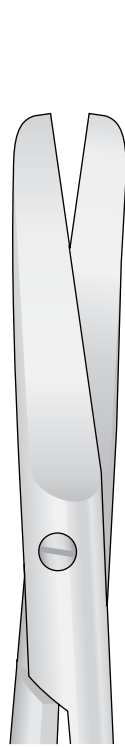

OS 219-01
20 cm
Straight

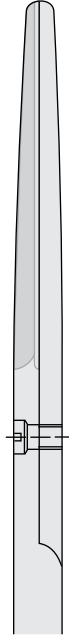

1/1

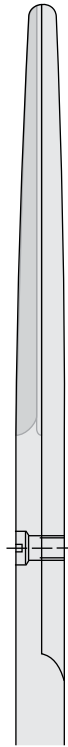

OS 219-02
23 cm
Straight



1/1



OS 219-03
20 cm
Curved

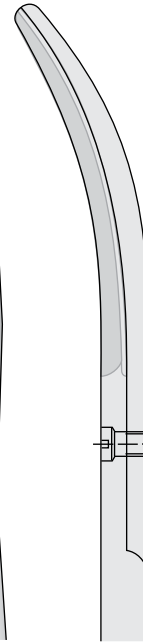

1/1



OS 219-04
23 cm
Curved



1/1

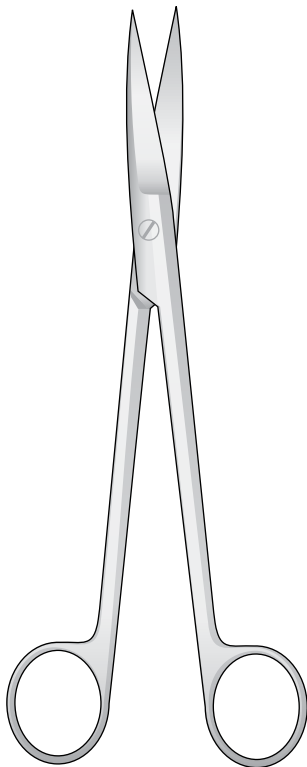

SIMS

OS 220-20 20 cm



20 cm

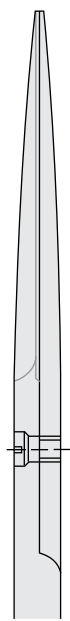

1/1

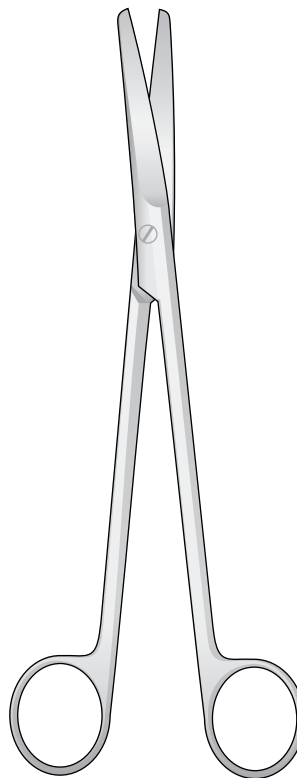

SIMS

OS 221-21 21 cm



21 cm

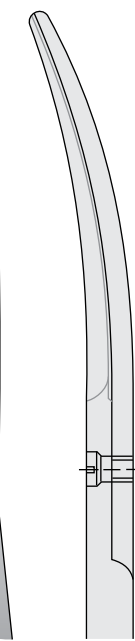

1/1

Forbici chirurgich
 Operating scissor
 Chirurgische Schere
 Ciseaux chirurgicau
 Tijeras para cirurgia general

Forbici per episiotomia - Episotomy scissors
 Episotomie-Scheren - Ciseaux à épisotomie
 Tijeras para episiotomia

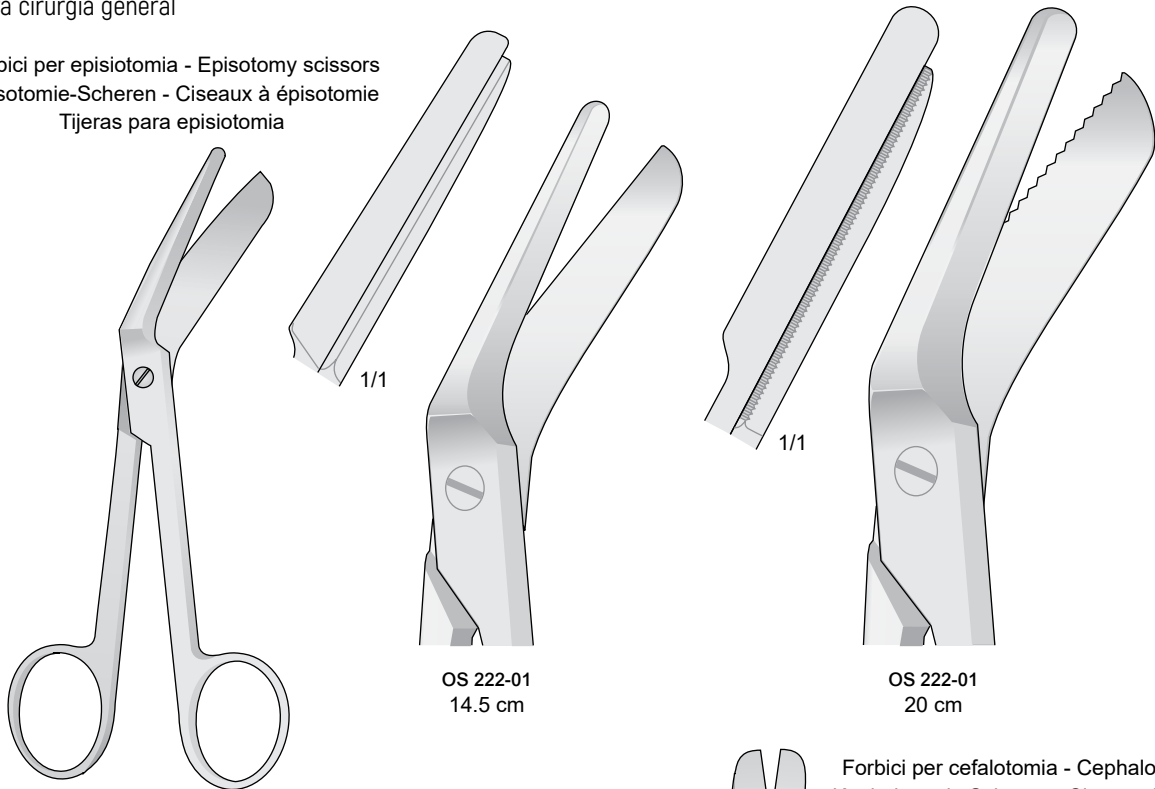

OS 222-01
14.5 cm

OS 222-01
20 cm

BRAUN-STADLER

OS 222-01 / OS 222-02

Forbici per cordone ombelicale - Umbilical cord scissors
 Nabelschnur Scheren - Ciseaux à cordon ombilical
 Tijeras umbilicales

Forbici per cefalotomia - Cephalotomy scissors
 Kephalotomie Scheren - Ciseaux à cèphalotomie
 Tijeras para cefalotomia



OS 223-01
13.5 cm

OS 223-02
16 cm

OS 224-01
27 cm
Straight

OS 224-02
27 cm
Curved

OS 223-01 / OS 223-02

DUBOIS
OS 224-01 / OS 224-02

Forbici per utero
Uterine scissors
Uterusschere
Ciseaux utérins
Tijeras para útero

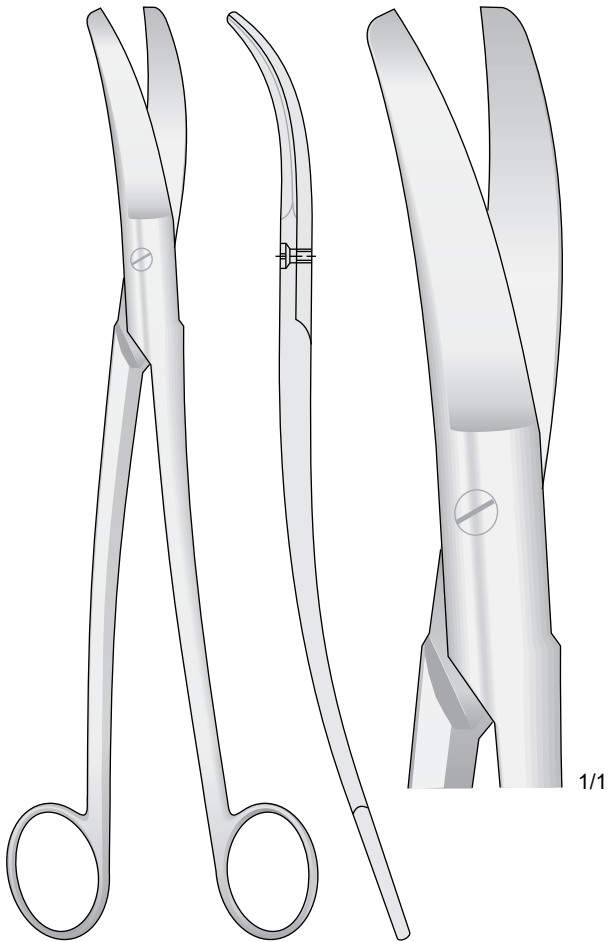

SIEBOLD
OS 225-24 24.5 cm

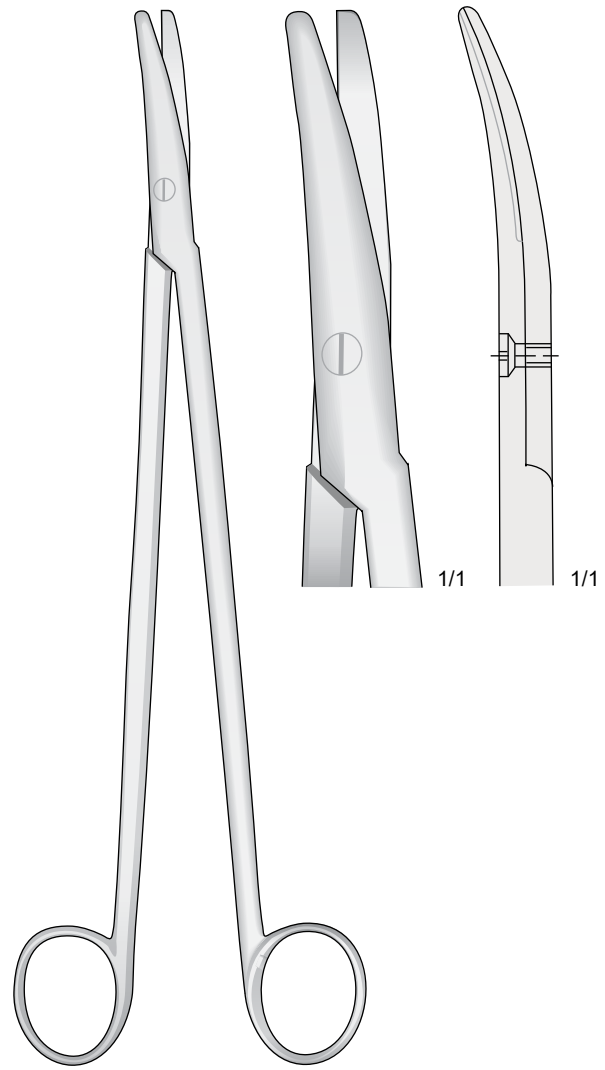

WELLER
OS 226-28 28 cm

Forbici chirurgich
Operating scissor
Chirurgische Schere
Ciseaux chirurgicau
Tijeras para cirurgia general

Forbici per Enterotomia
Bowel Scissors
Darmscheren
Ciseaux-Entérotomes
Enteròtomos

Forbici per Episiotomia
Episiotomy Scissors
Episiotomie-Scheren
Ciseaux à épisiotomie
Tijeras para Episiotomia

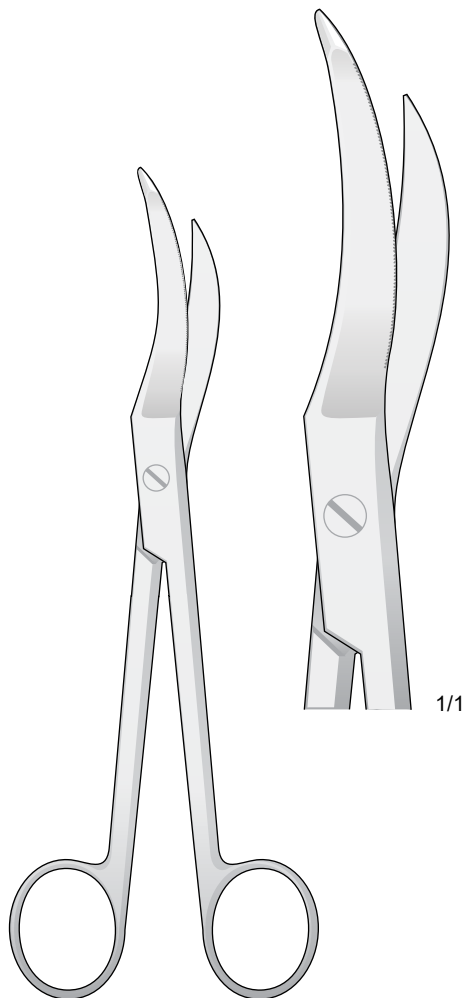

WALDMANN
OS 227-18 18 cm

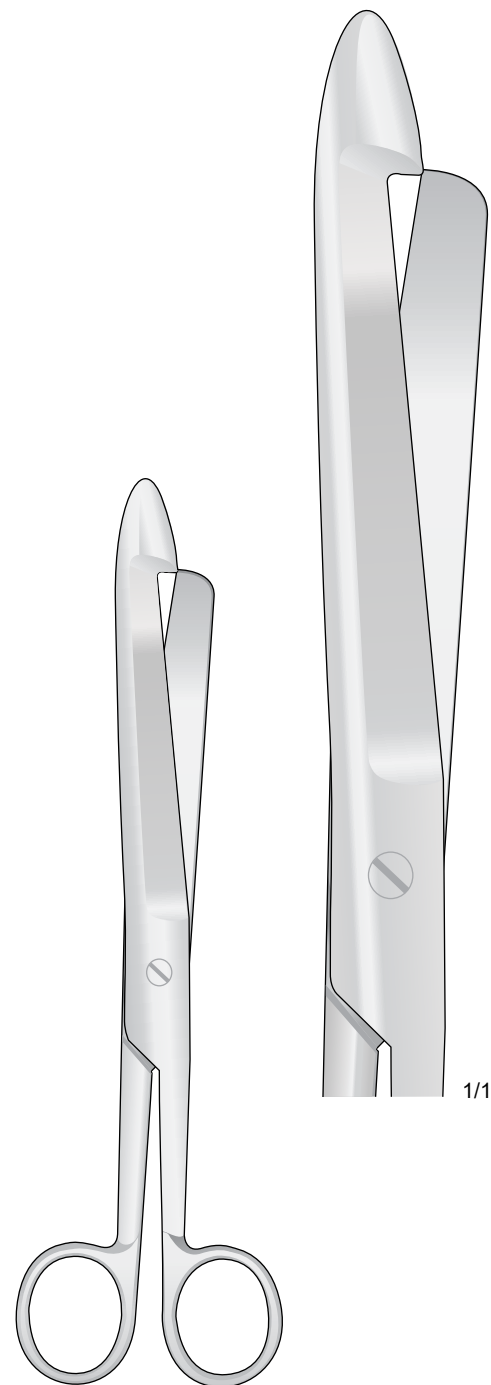

OS 228-21 21 cm

Forbici "super-cut" e Straightemamente taglienti per tessuti con riduzione del trauma - "Super-cut" scissors for gripping tissue and cutting interproximally
"Super-cut" scheren micro-schliff für tissue atrauma - Ciseaux "super cut" coupe les tissus en reduisant les risques de traumatisme
Tijeras "super cortes" para cortar tissue-atrauma

Forbici Dentellate
Scissors Serrateds
Gezahnte Scheren
Ciseaux Dentelé
Tijeras Dentada

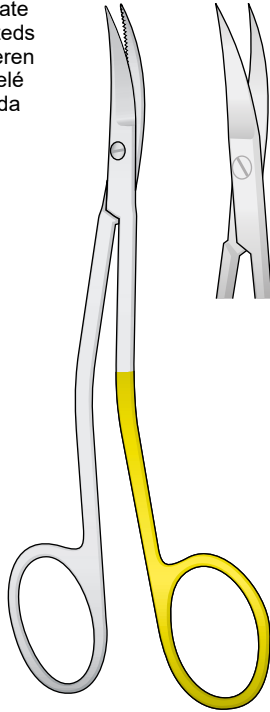

LA GRANGE
OS 229-01 / OS 229-02

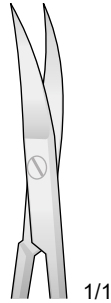

1/1

Acute
Sharp
Spitz
Pointu
Agudas

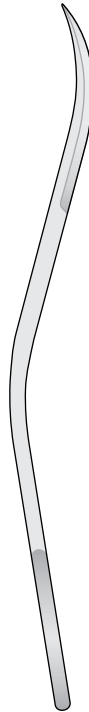

LA GRANGE
OS 229-01
11.5 cm

Smusse
Blunt
Stumpf
Mousse
Romas

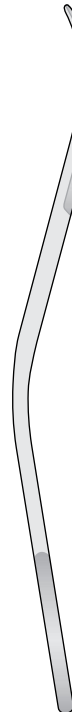

LA GRANGE
OS 229-02
11.5 cm

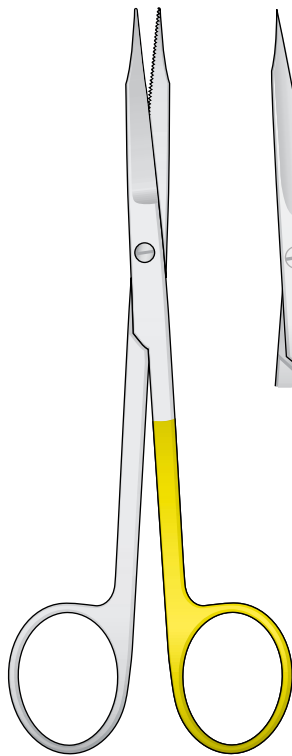

GOLDMAN-FOX
OS 230-01 / OS 230-02



1/1

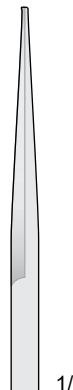

1/1

OS 230-01
13.5 cm



1/1

OS 230-02
13.5 cm

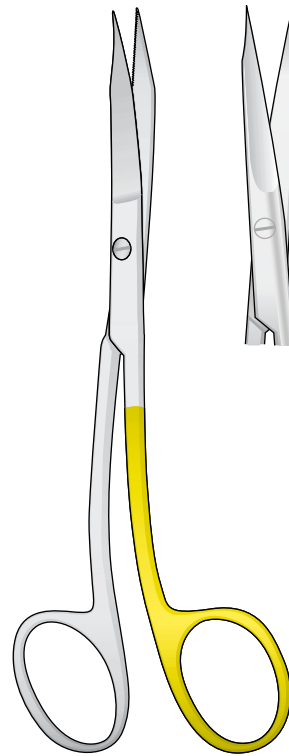

GOLDMAN-FOX S FORM
OS 231-13 13 cm



1/1

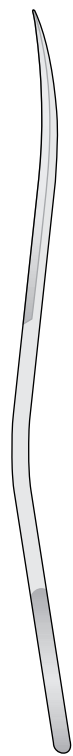

Forbici chirurgich
 Operating scissor
 Chirurgische Schere
 Ciseaux chirurgicau
 Tijeras para cirugia general

Forbici "super-cut" e Straightemente taglienti per tessuti con riduzione del trauma - "Super-cut" scissors for gripping tissue and cutting interproximally
 "Super-cut" scheren micro-schliff für tissue atrauma - Ciseaux "super cut" coupe les tissus en reduisant les risques de traumatisme
 Tijeras "super cortes" para cortar tissue-atrauma

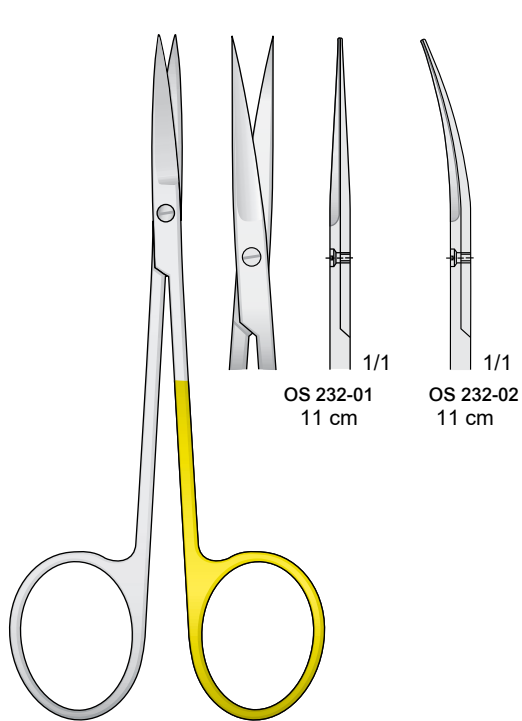

IRIS

OS 232-01 / OS 232-02

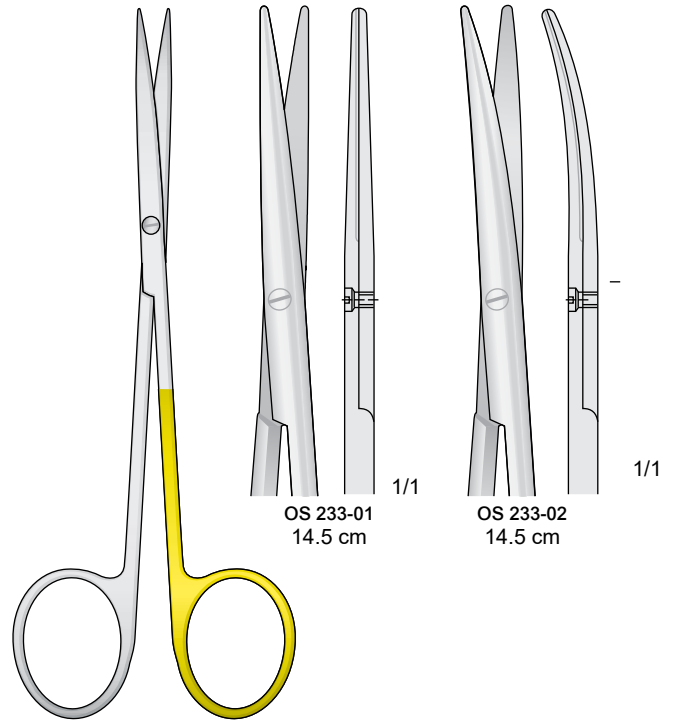

METZENBAUM

OS 233-01 / OS 233-02

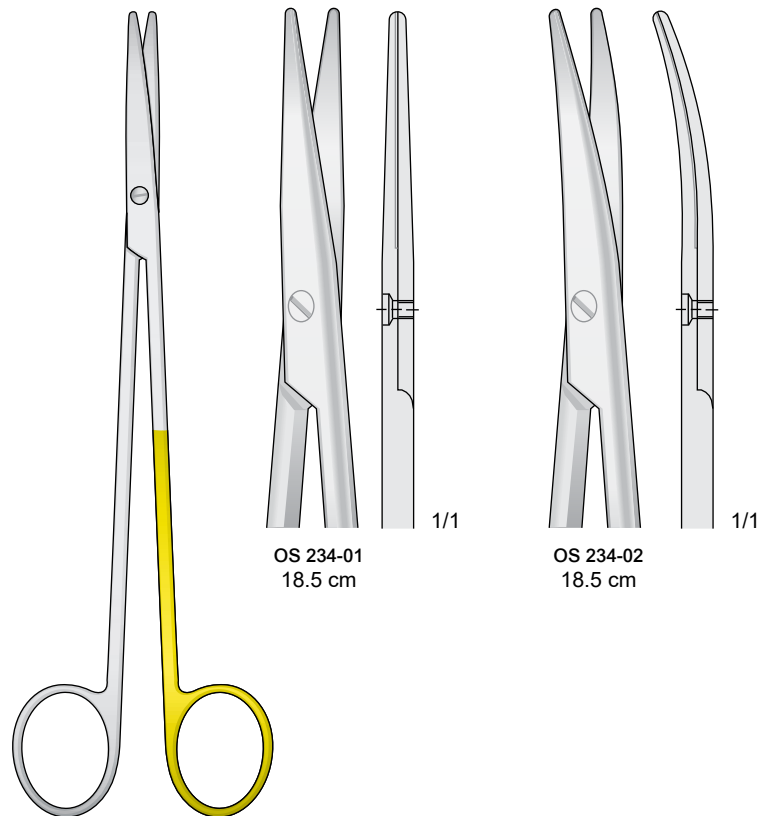

METZENBAUM

OS 234-01 / OS 234-02



Forbici "super-cut" e Straightemente taglienti per tessuti con riduzione del trauma - "Super-cut" scissors for gripping tissue and cutting interproximally
"Super-cut" scheren micro-schliff für tissue atrauma - Ciseaux "super cut" coupe les tissus en reduisant les risques de traumatisme
Tijeras "super cortes" para cortar tissue-atrauma

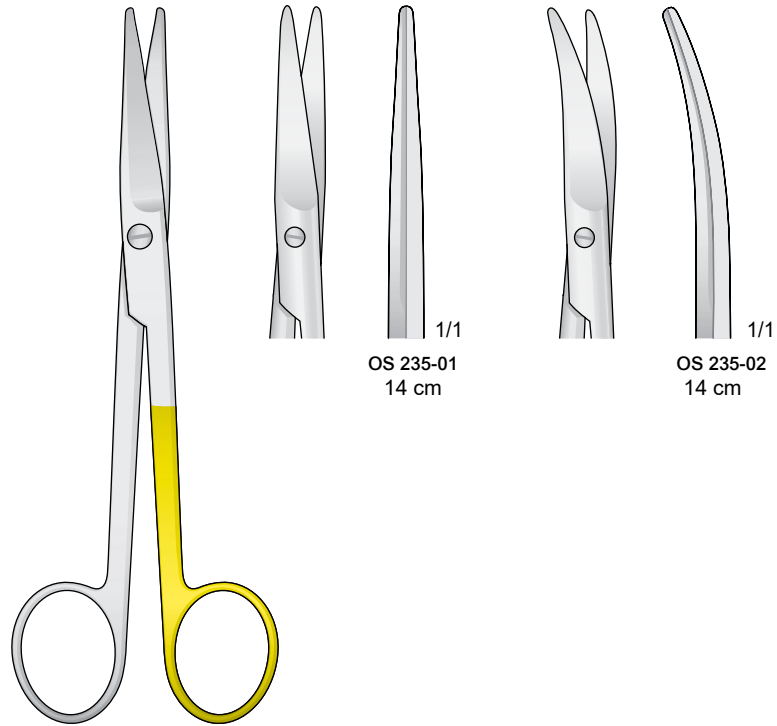

MAYO

OS 235-01 / OS 235-02

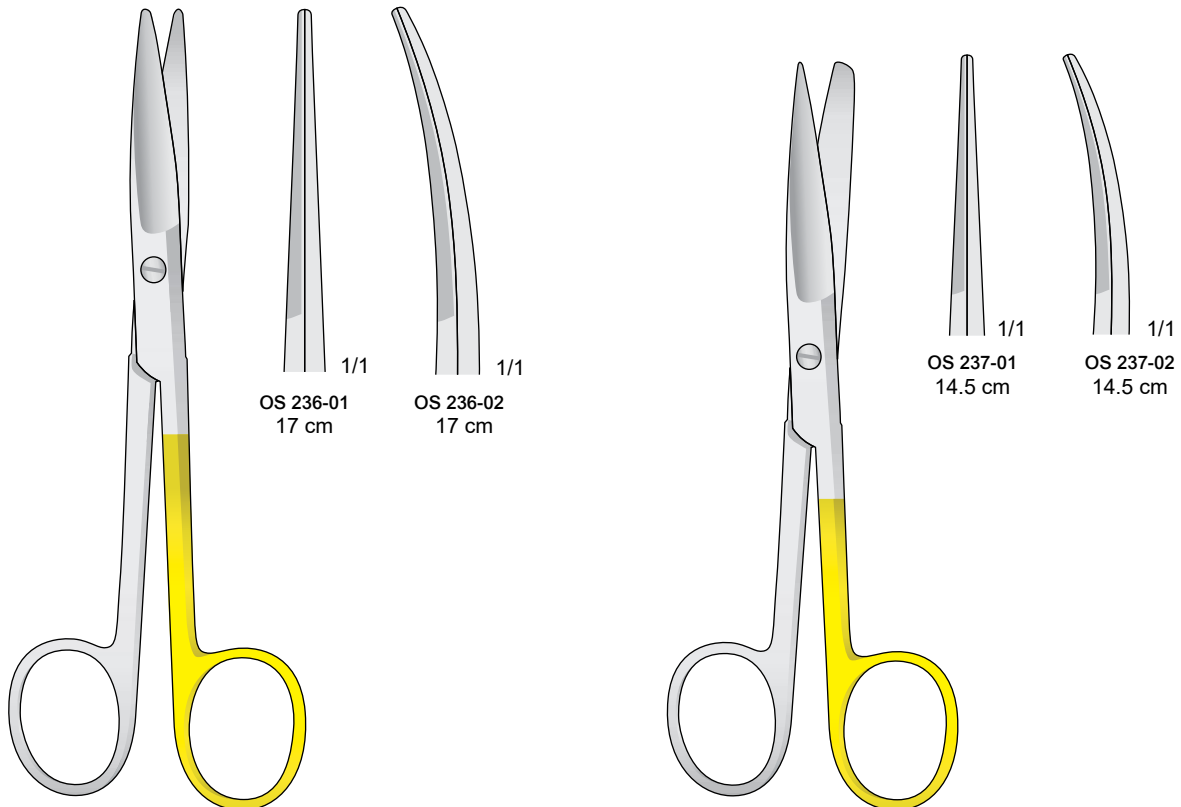

MAYO

OS 236-01 / OS 236-02

OS 237-01 / OS 237-02

Forbici per mancini
 Left scissors
 Links Scheren
 Gauche Ciseaux
 Tijeras para zurdos

L = mancini
 left
 links
 gauche
 izquierdo

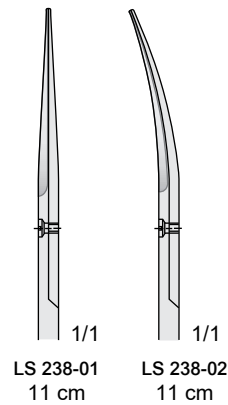
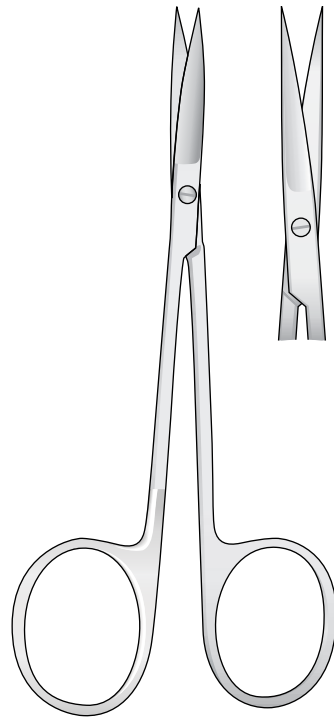

IRIS

LS 238-01 / LS 238-02

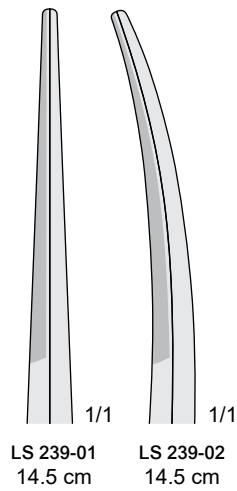
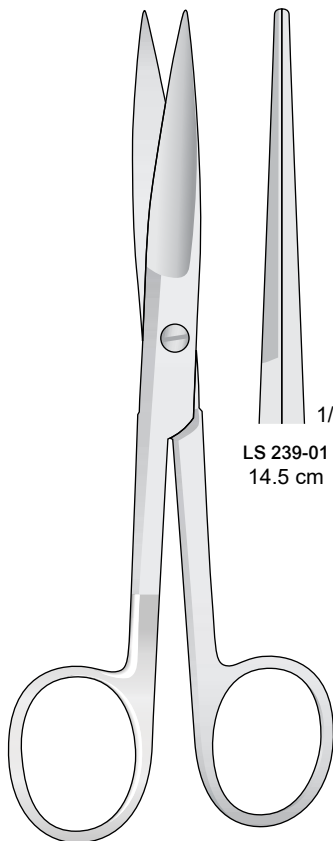

LS 239-01 / LS 239-02

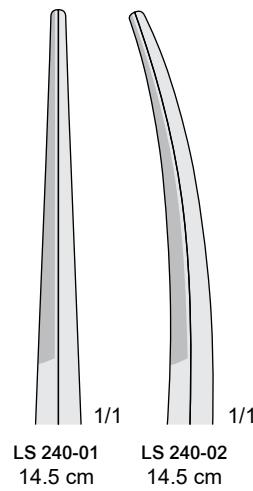
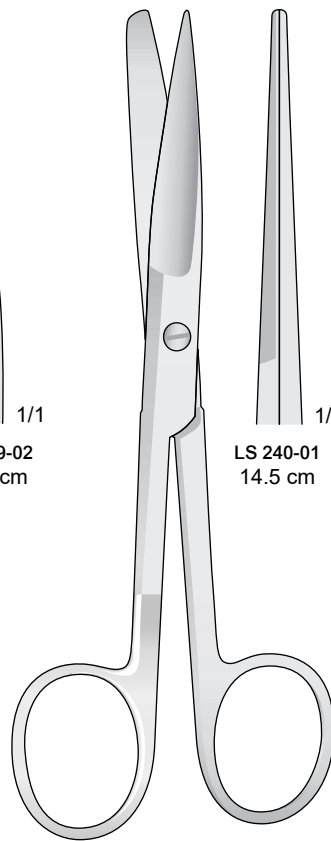

LS 240-01 / LS 240-02

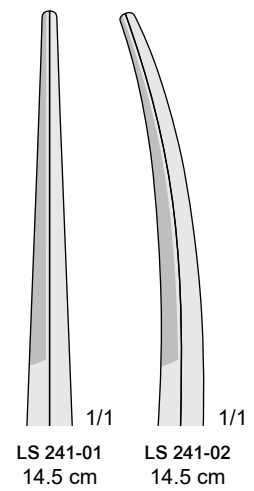
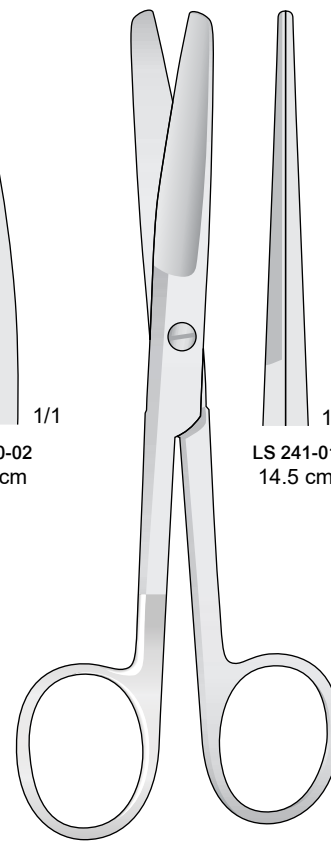

LS 241-01 / LS 241-02



Con punta al carburo di tungsteno - Tungsten-carbide scissors
Mit Hartmetalleinsätzen - Avec plaquettes en carbure de tungstène - Tijeras de tungsteno

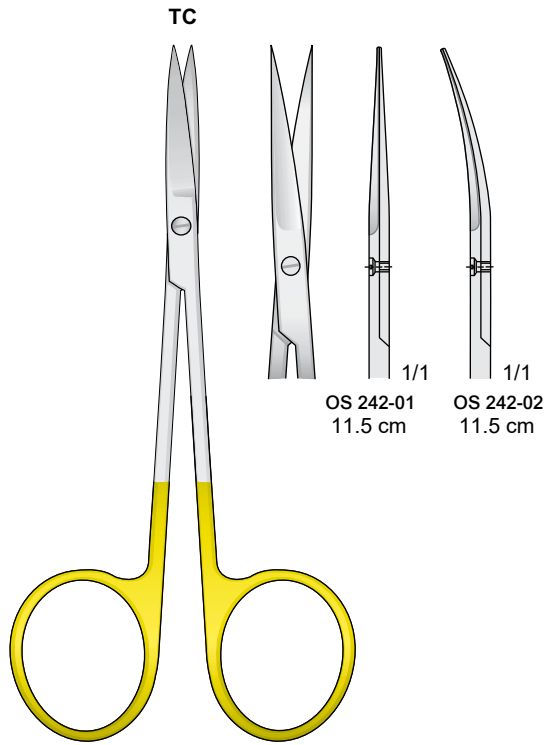

IRIS
OS 242-01 / OS 142-02

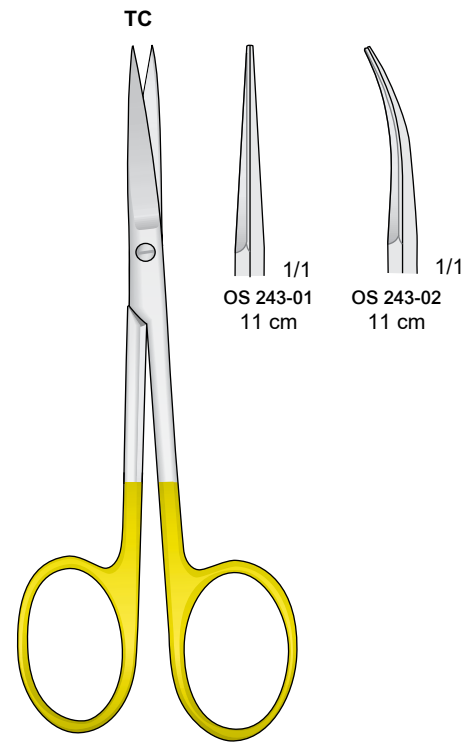

OS 243-01 / OS 143-02

Dentellata
Serrated
Gezahnt
Dentée
Dentadas

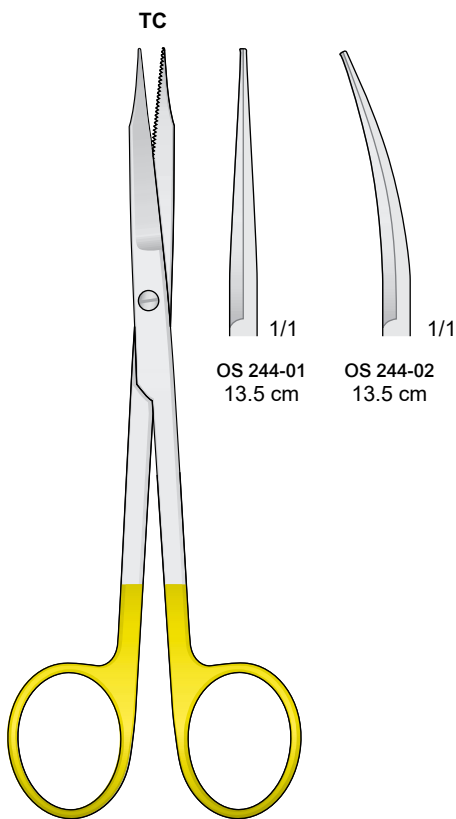

GOLDMAN-FOX
OS 244-01 / OS 144-02

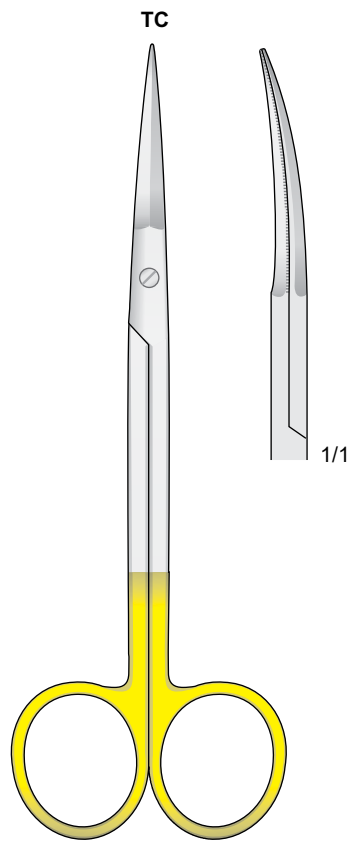

PECK-JOSEPH
OS 245-14 14 cm

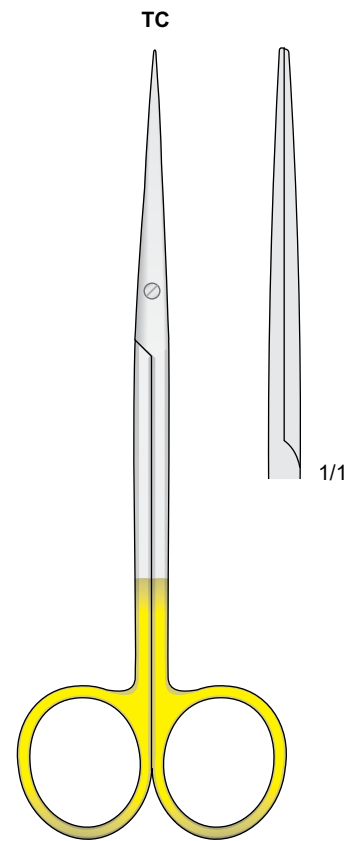

METZENBAUM-FINO
OS 246-14 14 cm

Con punta al carburo di tungsteno - Tungsten-carbide scissors
 Mit Hartmetalleinsätzen - Avec plaquettes en carbure de tungstène - Tijeras de tungsteno

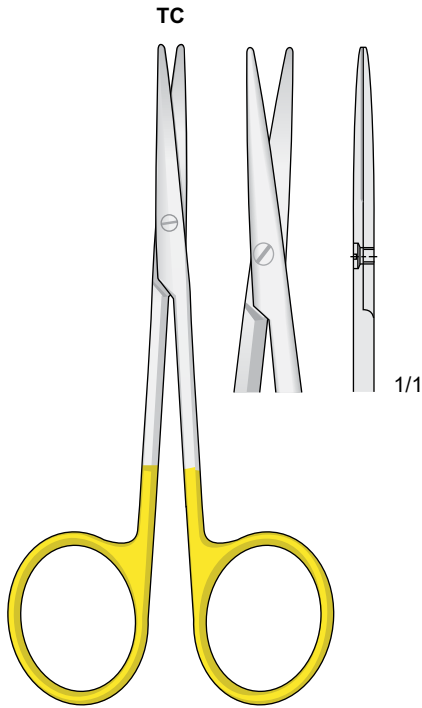

OS 247-11 11.5 cm

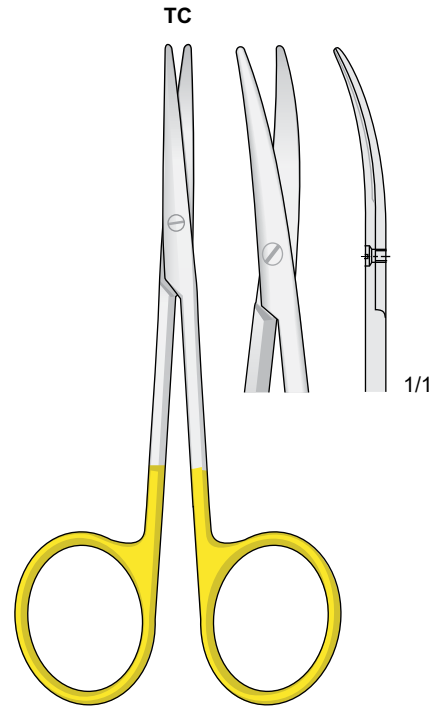

OS 248-11 11.5 cm

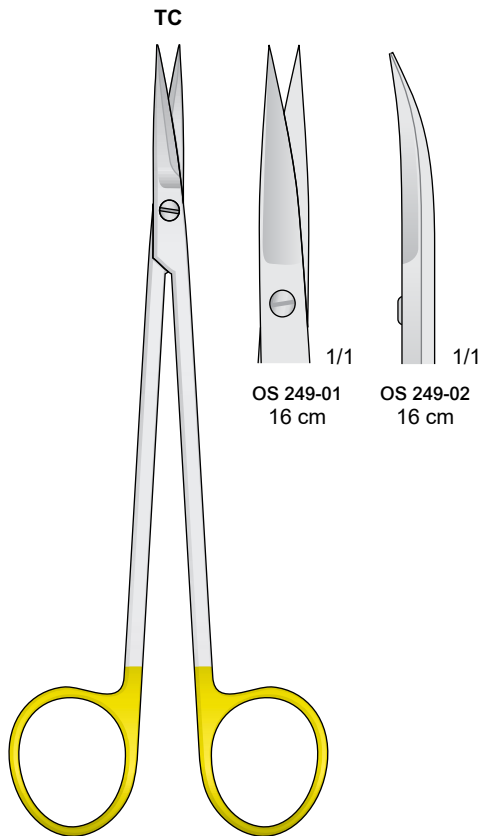

KELLY
OS 249-01 / OS 149-02

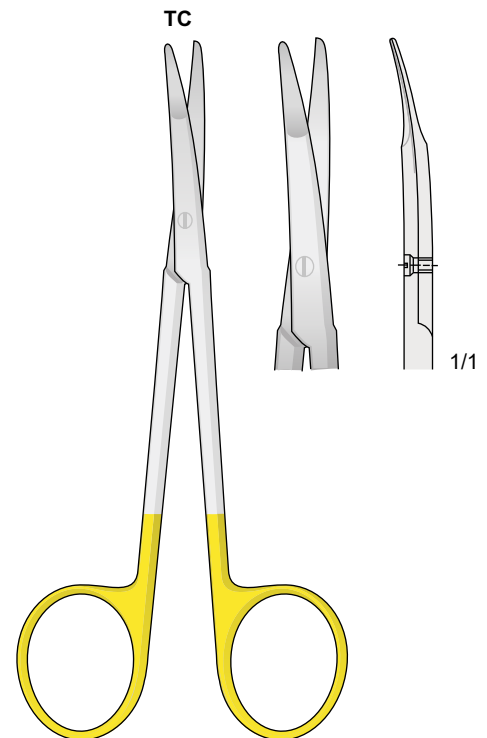

KILNER (RAGNELL)
OS 250-12 12.5 cm

Con punta al carburo di tungsteno - Tungsten-carbide scissors
Mit Hartmetalleinsätzen - Avec plaquettes en carbure de tungstène - Tijeras de tungsteno

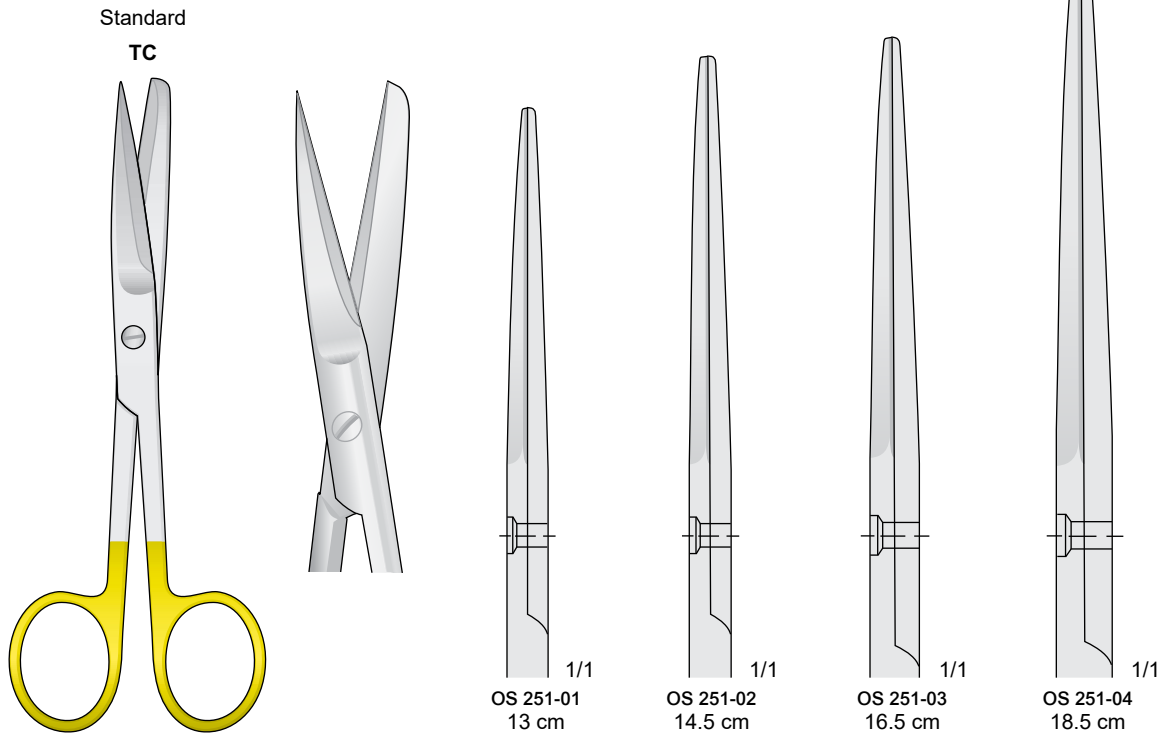

Con punta al carburo di tungsteno - Tungsten-carbide scissors
 Mit Hartmetalleinsätzen - Avec plaquettes en carbure de tungstène - Tijeras de tungsteno

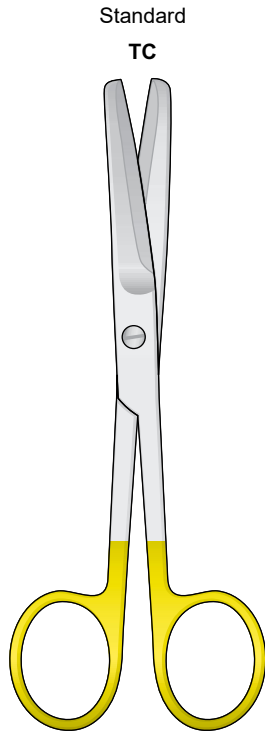

OS 253-01 / OS 253-04

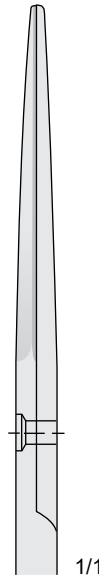
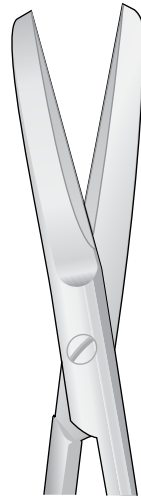

OS 253-01
13 cm

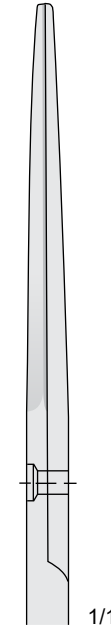

OS 253-02
14.5 cm

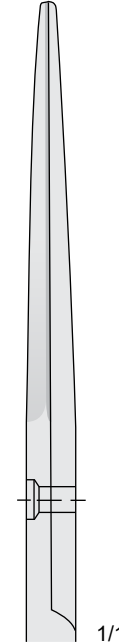

OS 253-03
16.5 cm

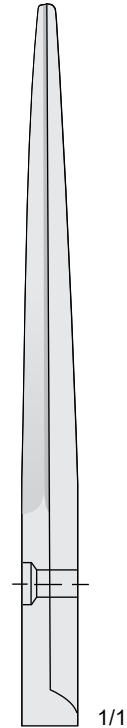

OS 253-04
18.5 cm

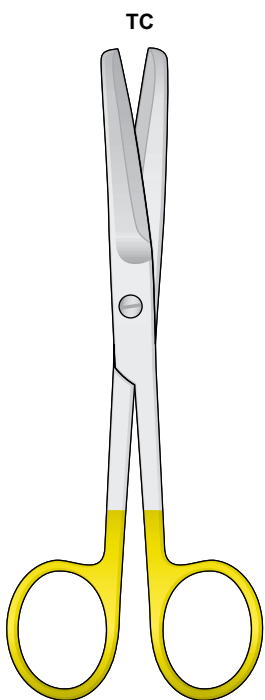

OS 254-01 / OS 254-03

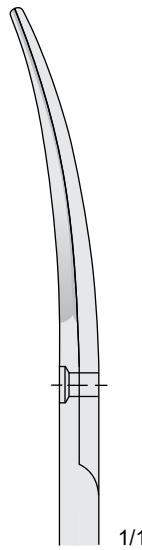
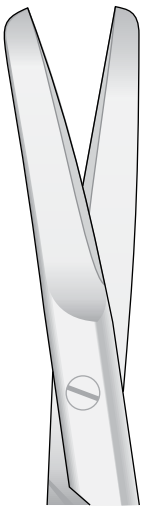

OS 254-01
13 cm

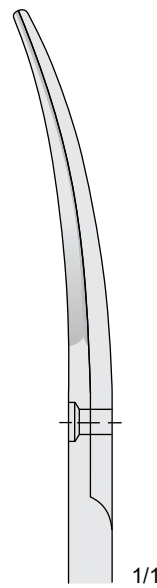

OS 254-02
14.5 cm

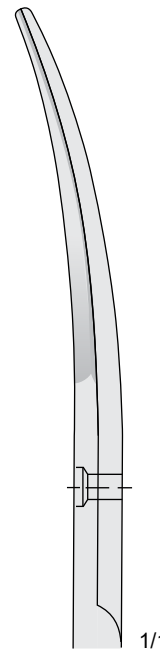

OS 254-03
16.5 cm

Con punta al carburo di tungsteno - Tungsten-carbide scissors
Mit Hartmetalleinsätzen - Avec plaquettes en carbure de tungstène - Tijeras de tungsteno

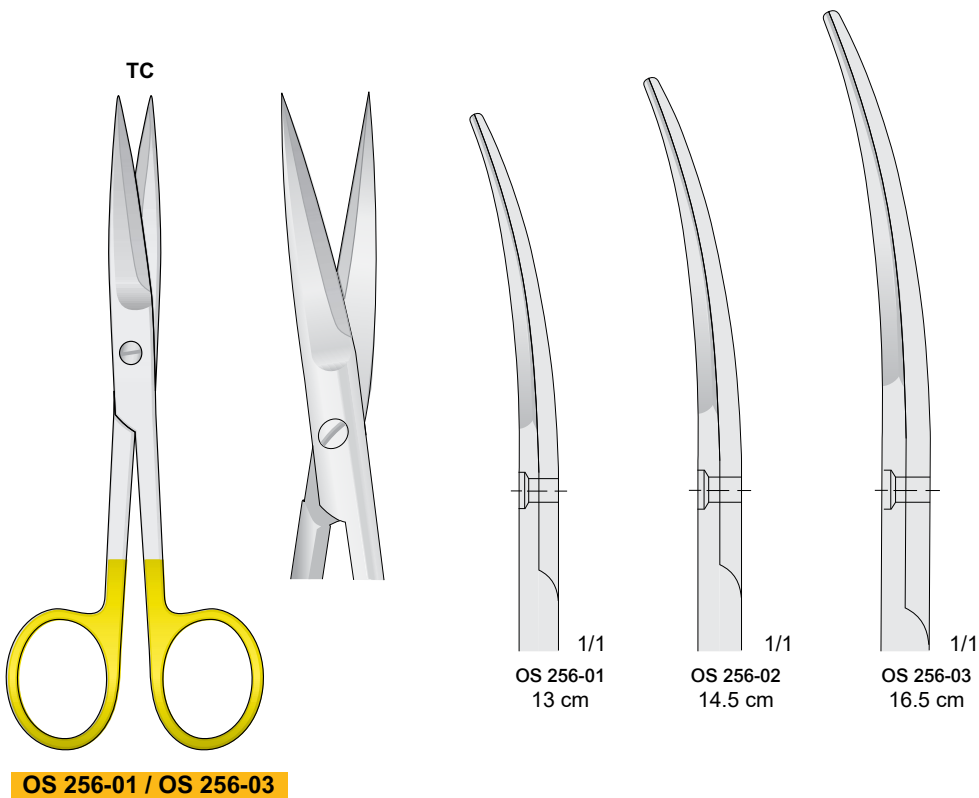
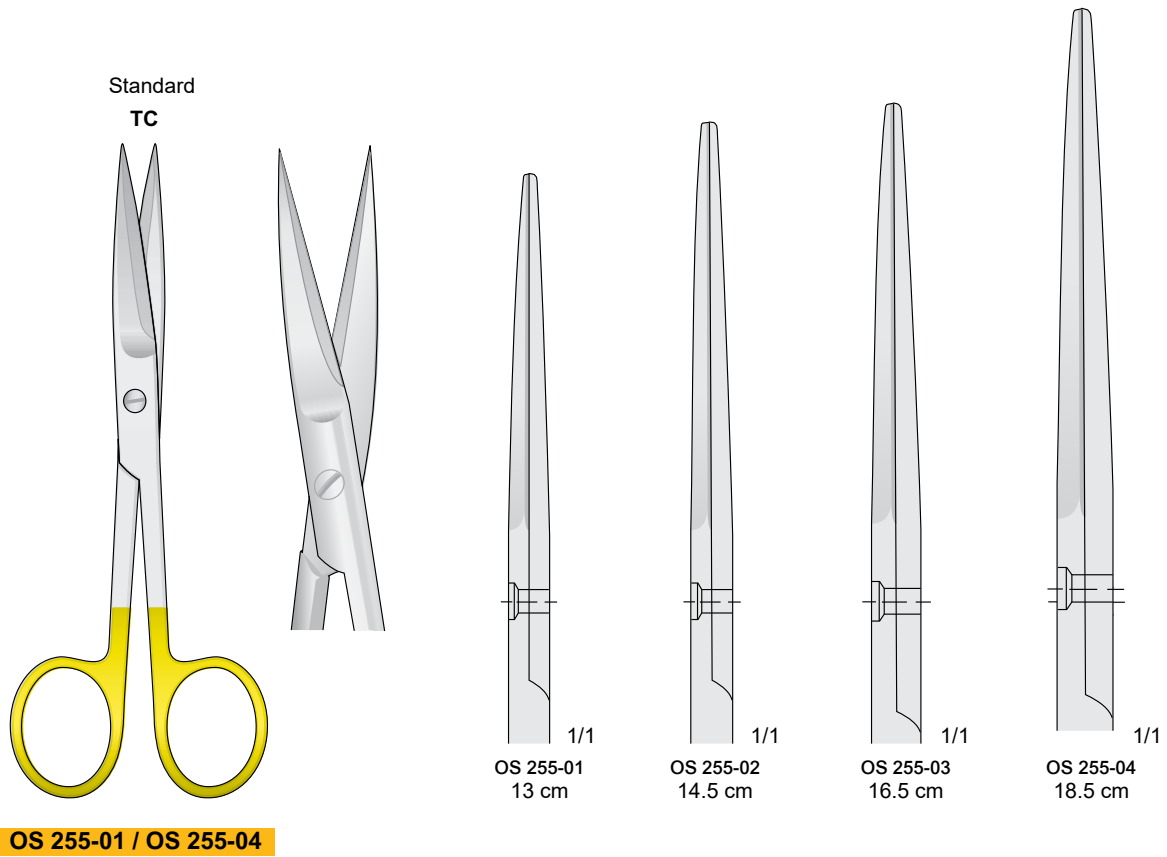

Con punta al carburo di tungsteno - Tungsten-carbide scissors
 Mit Hartmetalleinsätzen - Avec plaquettes en carbure de tungstène - Tijeras de tungsteno

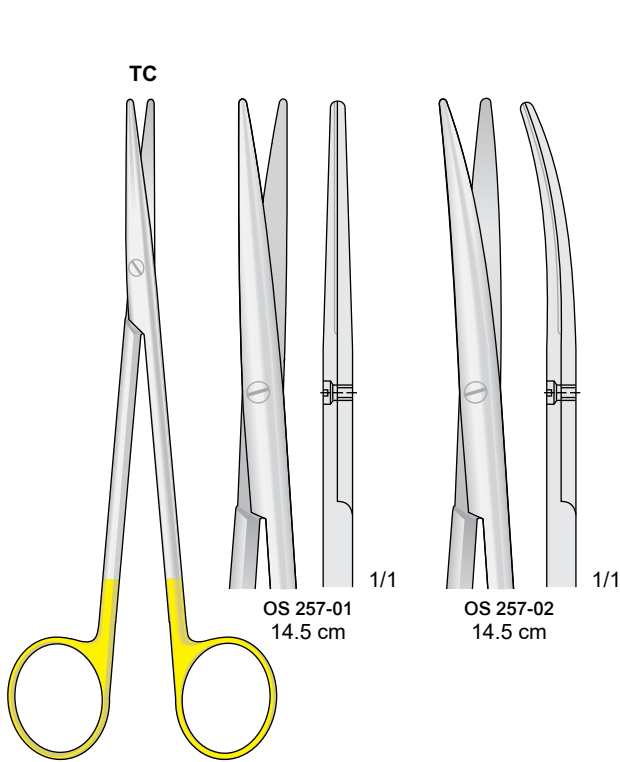

METZENBAUM
OS 257-01 / OS 257-02

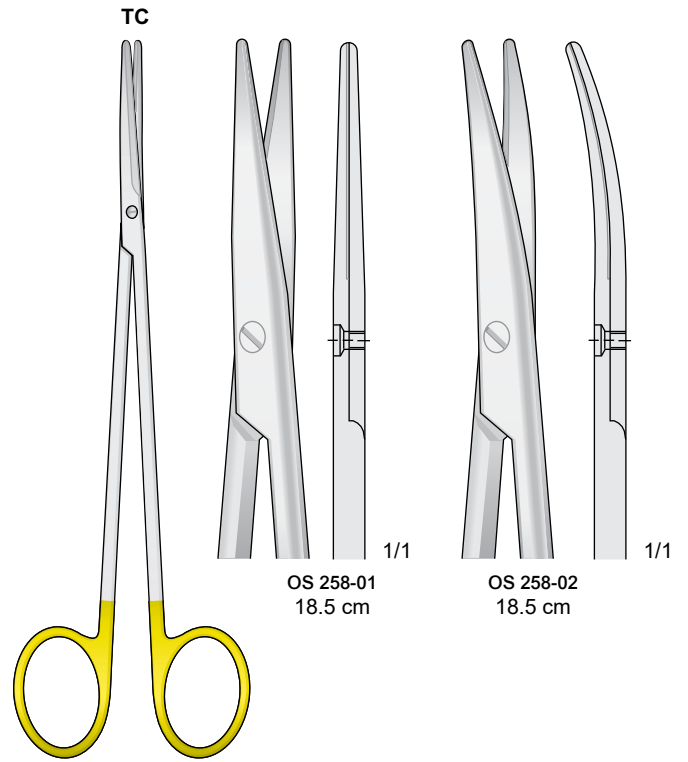

METZENBAUM
OS 258-01 / OS 258-02

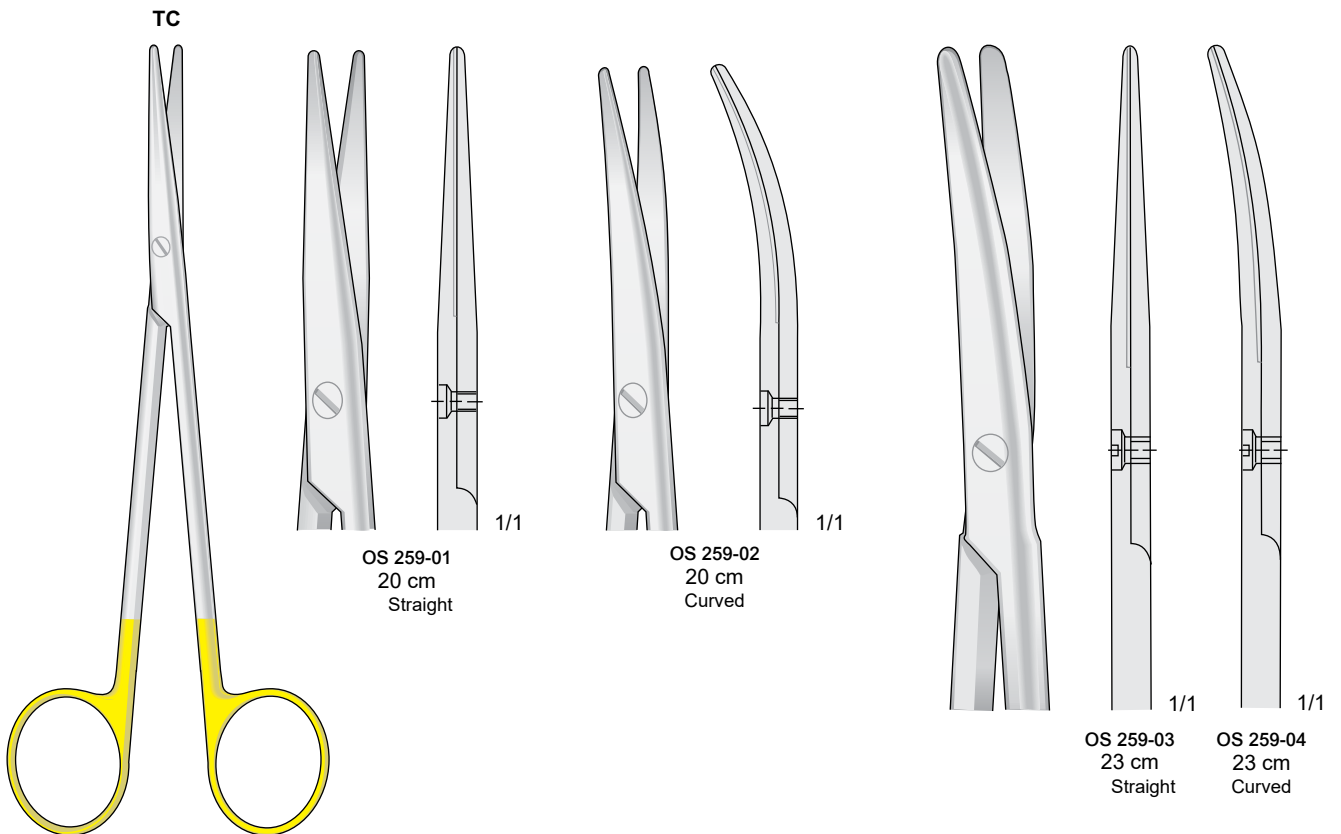

METZENBAUM
OS 259-01 / OS 259-04

Con punta al carburo di tungsteno - Tungsten-carbide scissors
Mit Hartmetalleinsätzen - Avec plaquettes en carbure de tungstène - Tijeras de tungsteno

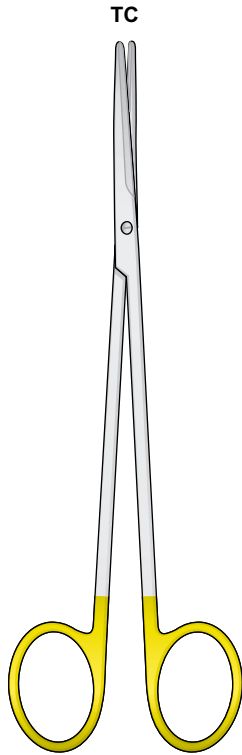

METZENBAUM-FINO

OS 260-01 / OS 260-03

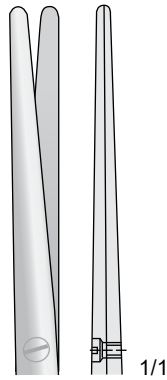

OS 260-01
14 cm

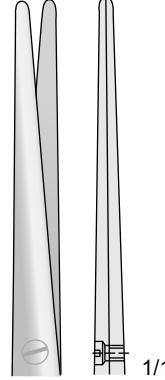

OS 260-02
18 cm

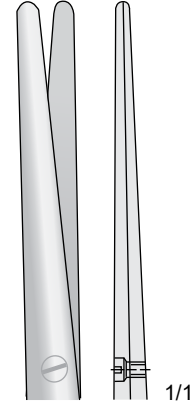

OS 260-03
20 cm

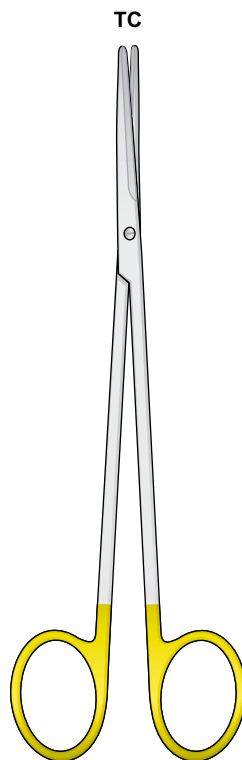

METZENBAUM-FINO

OS 261-01 / OS 261-03

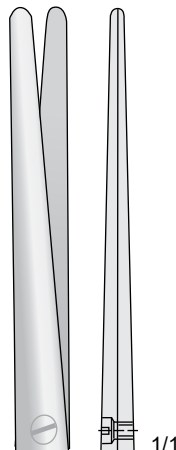

OS 261-01
23 cm

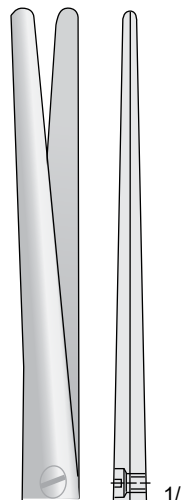

OS 261-02
25 cm

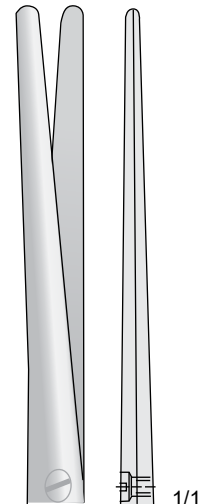

OS 261-03
28 cm

Forbici chirurgich
 Operating scissor
 Chirurgische Schere
 Ciseaux chirurgicau
 Tijeras para cirugia general

Con punta al carburo di tungsteno - Tungsten-carbide scissors
 Mit Hartmetalleinsätzen - Avec plaquettes en carbure de tungstène - Tijeras de tungsteno

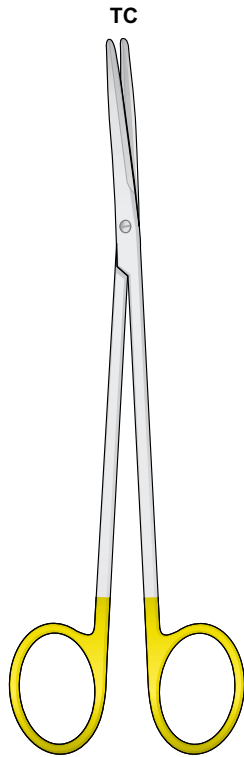

METZENBAUM-FINO
OS 262-01 / OS 262-03

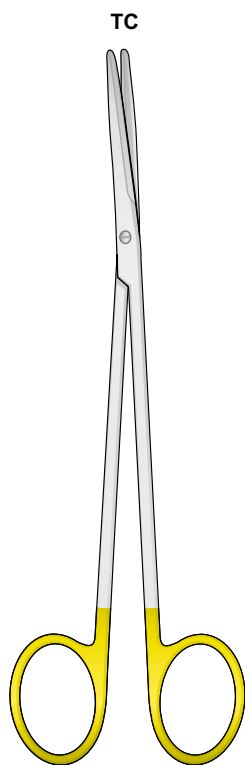
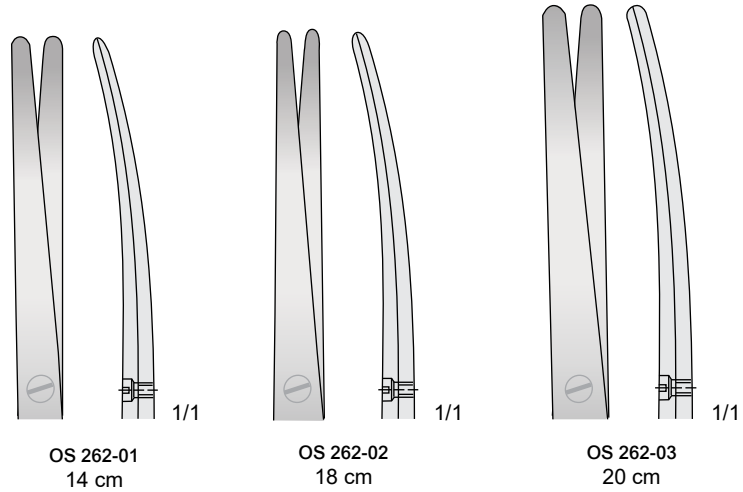

METZENBAUM-FINO
OS 263-01 / OS 263-03

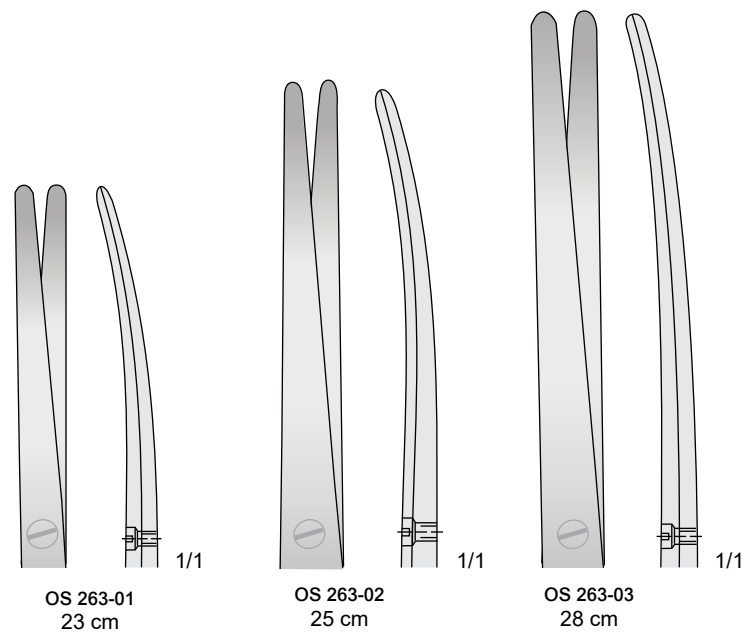

Con punta al carburo di tungsteno - Tungsten-carbide scissors
Mit Hartmetalleinsätzen - Avec plaquettes en carbure de tungstène - Tijeras de tungsteno

TC

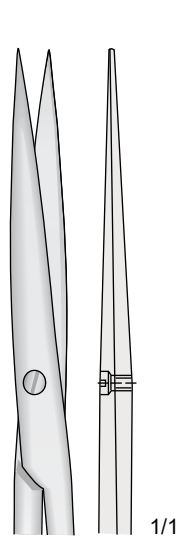
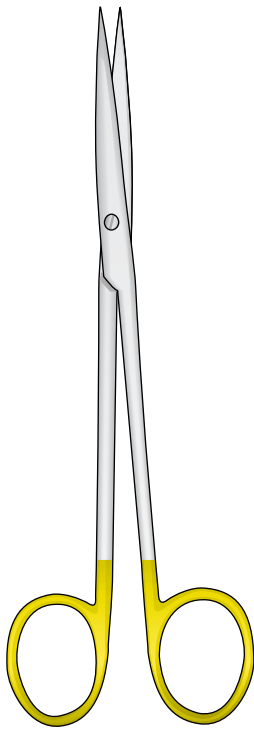

OS 264-01
14 cm
Straight

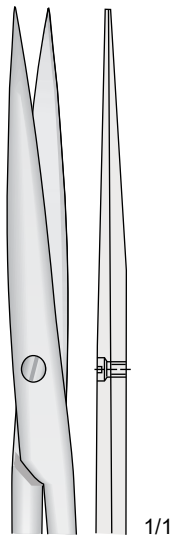

OS 264-02
18 cm
Straight

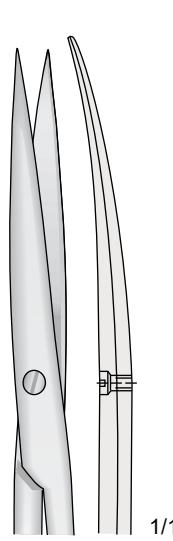

OS 264-03
14 cm
Curved

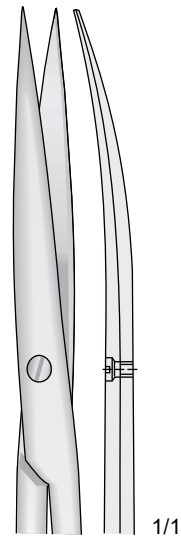

OS 264-04
18 cm
Curved

METZENBAUM-FINO

OS 264-01 / OS 264-04

TC

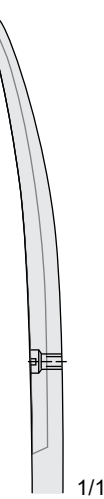
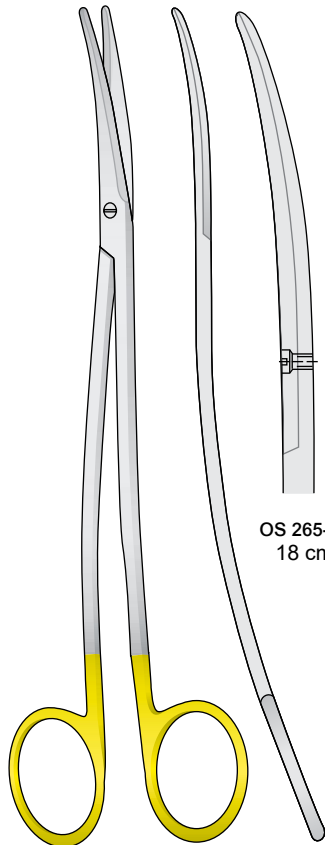

OS 265-01
18 cm

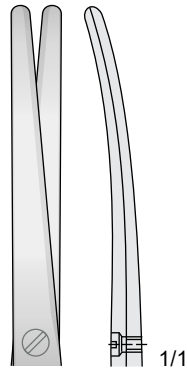

OS 265-02
20 cm



OS 265-03
23 cm

METZENBAUM-FINO

OS 265-01 / OS 265-03

TC

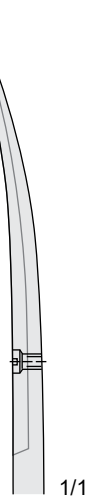
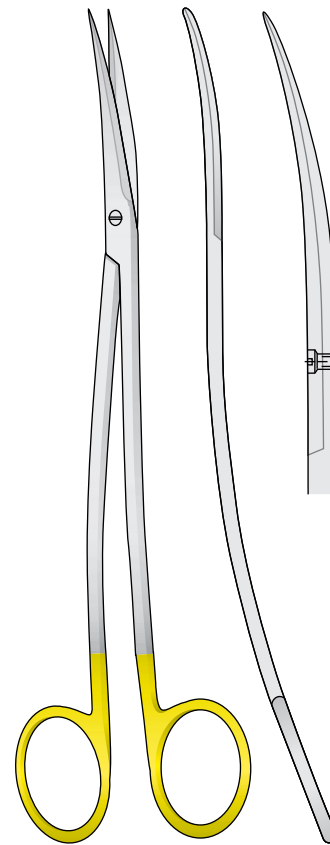

METZENBAUM-FINO

OS 266-18 18 cm

Con punta al carburo di tungsteno - Tungsten-carbide scissors
 Mit Hartmetalleinsätzen - Avec plaquettes en carbure de tungstène
 Tijeras de tungsteno

TC

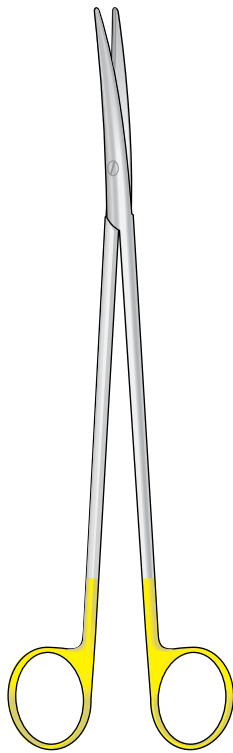

NELSON-METZENBAUM

OS 267-01 / OS 267-02

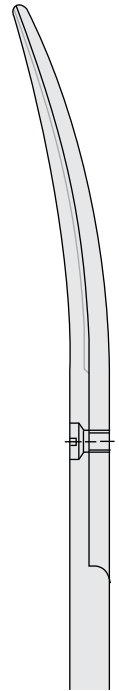
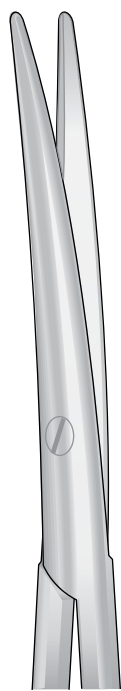

1/1

OS 267-01
26 cm

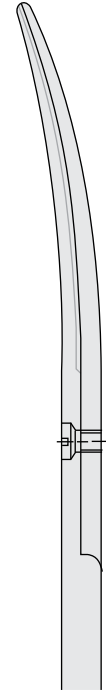

1/1

OS 267-02
28 cm

TC

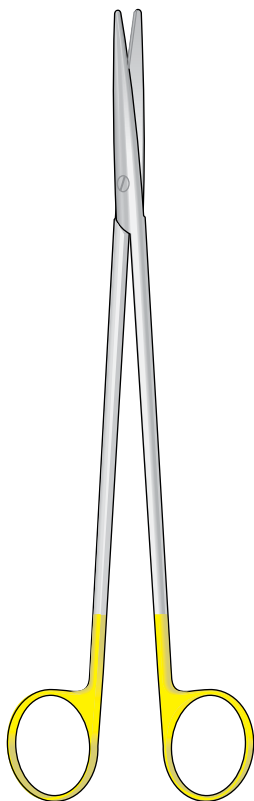

NELSON-METZENBAUM

OS 268-01 / OS 268-03



1/1

OS 268-01
23 cm

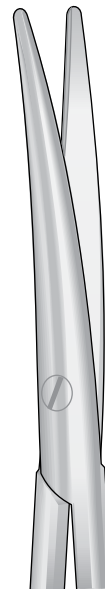

1/1

OS 268-02
23 cm



1/1

OS 268-03
30 cm

Con punta al carburo di tungsteno - Tungsten-carbide scissors
Mit Hartmetalleinsätzen - Avec plaquettes en carbure de tungstène - Tijeras de tungsteno

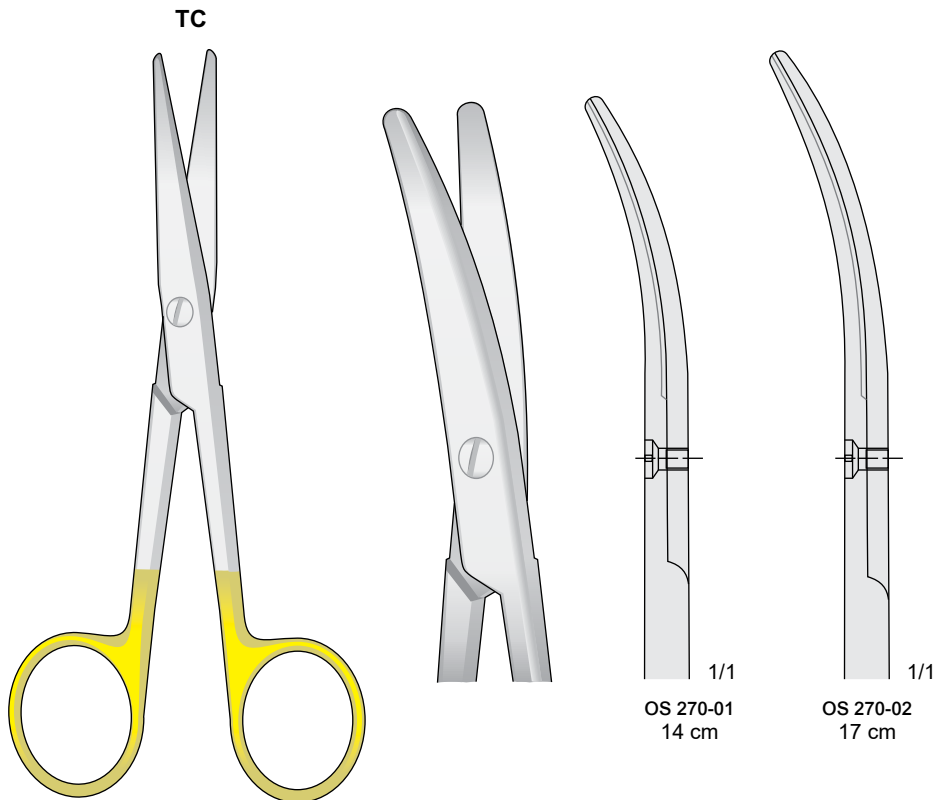
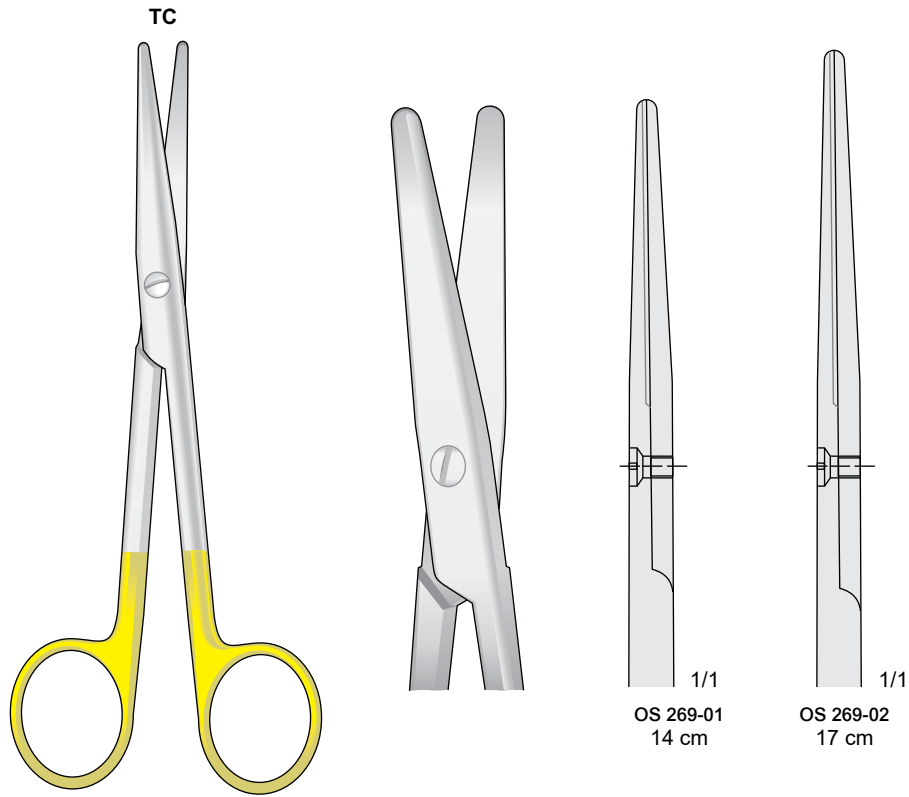

Con punta al carburo di tungsteno - Tungsten-carbide scissors
 Mit Hartmetalleinsätzen - Avec plaquettes en carbure de tungstène - Tijeras de tungsteno

TC

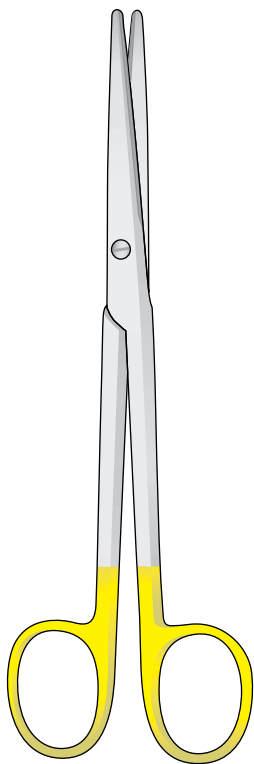

LEXER

OS 271-01 / OS 271-02

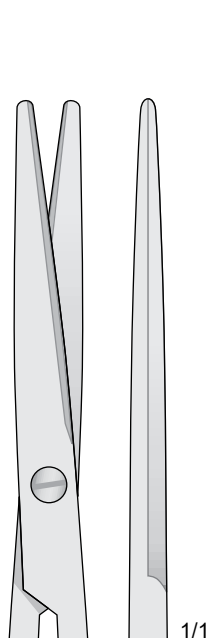

OS 271-01
16 cm

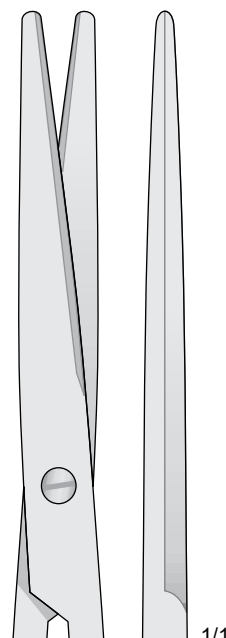

OS 271-02
21 cm

TC

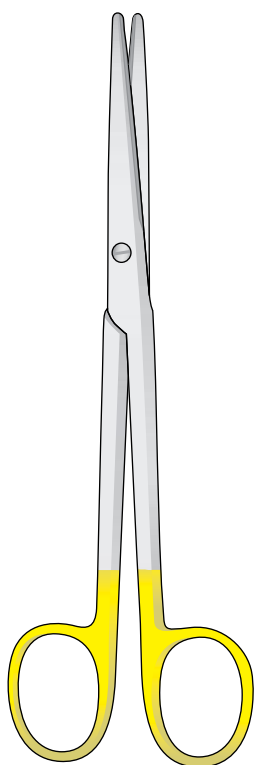

LEXER

OS 272-01 / OS 272-02

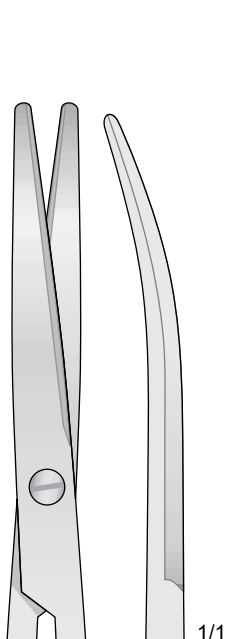

OS 272-01
16 cm

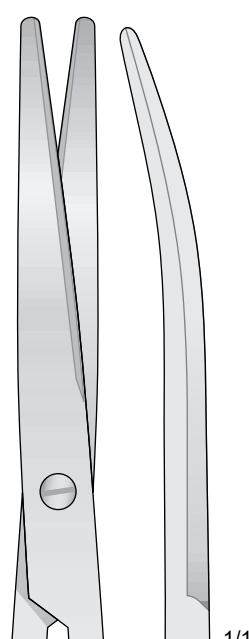

OS 272-02
21 cm

Con punta al carburo di tungsteno - Tungsten-carbide scissors
Mit Hartmetalleinsätzen - Avec plaquettes en carbure de tungstène - Tijeras de tungsteno

TC

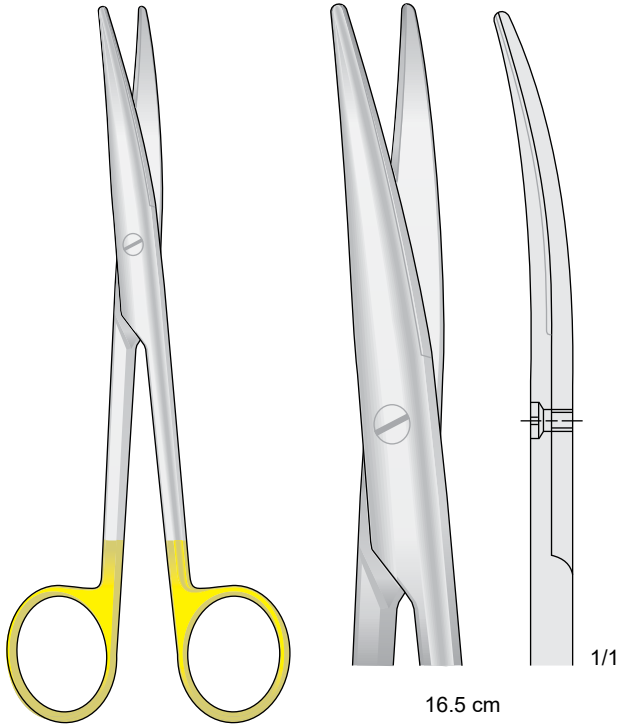

MAYO-LEXER

OS 273-16 16.5 cm

TC

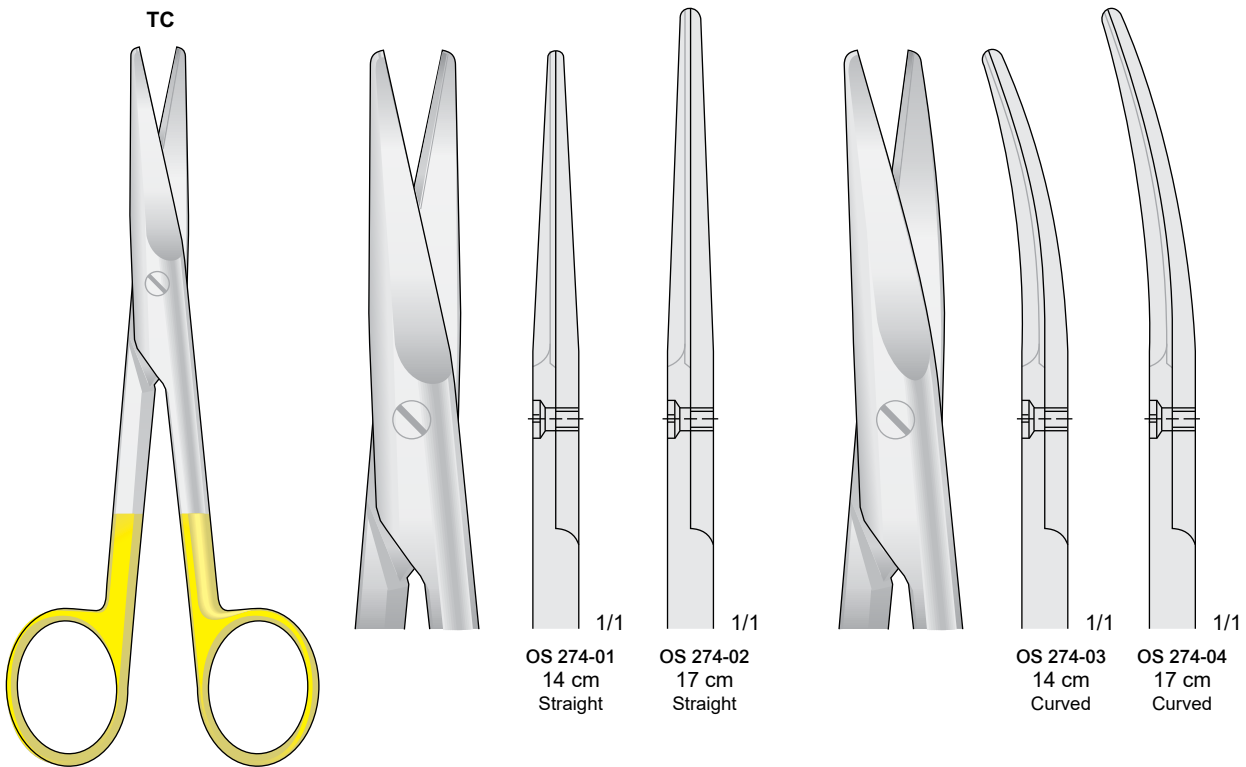

MAYO

OS 274-01 / OS 274-04

Forbici chirurgich
 Operating scissor
 Chirurgische Schere
 Ciseaux chirurgicaux
 Tijeras para cirugia general

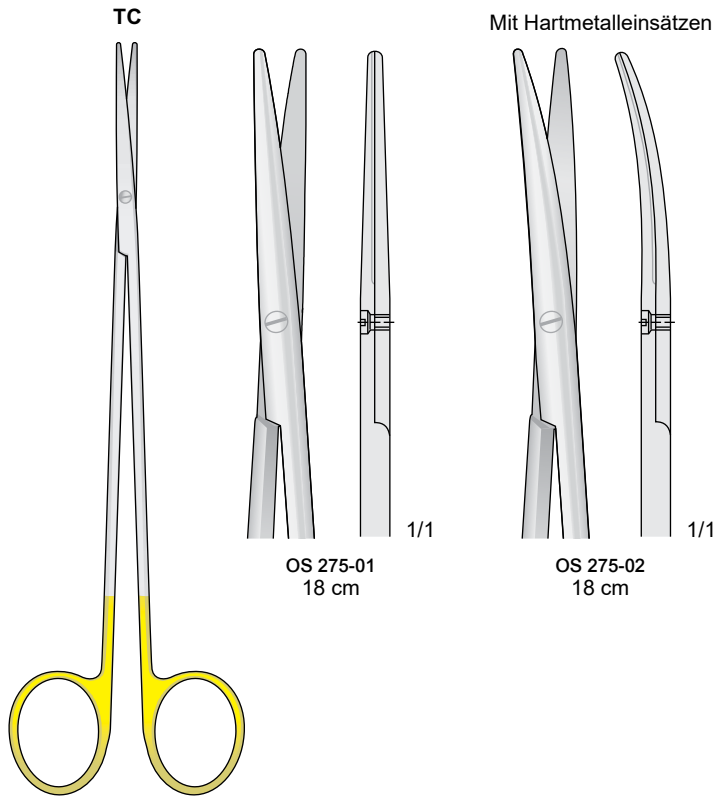

Con punta al carburo di tungsteno - Tungsten-carbide scissors
 Mit Hartmetalleinsätzen - Avec plaquettes en carbure de tungstène - Tijeras de tungsteno

TOENNIS-ADSON
OS 275-01 / OS 275-02

Forbice per isterectomia - Hysterectomy Scissors
 Hysterectomie Scheren - Ciseaux à Hystérectomie
 Tijera para Histerectomia

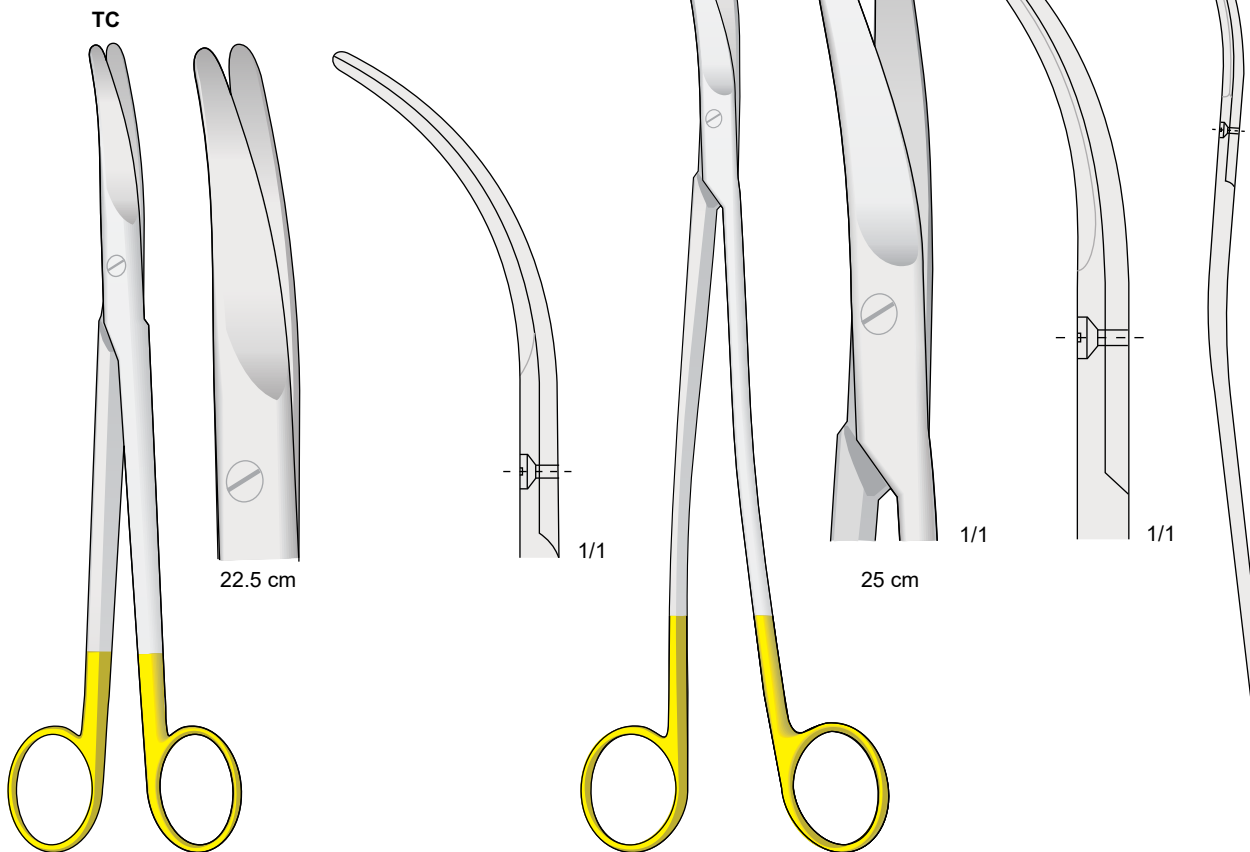

PARAMETRIUM-PARAMETRIO
OS 276-22 22.5 cm

OS 277-25 25 cm



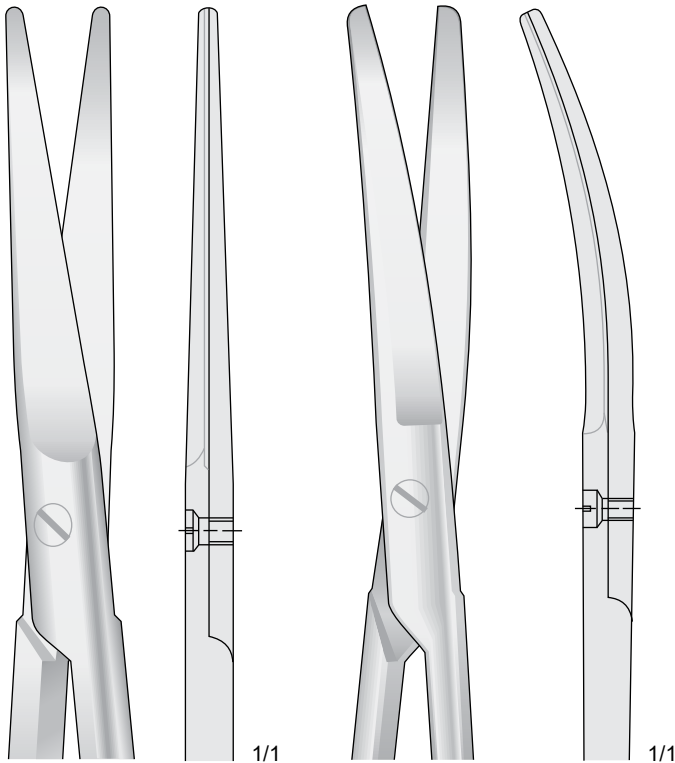

OS 278-01
23 cm

OS 278-02
23 cm

Con punta al carburo di tungsteno
Tungsten-carbide scissors
Mit Hartmetalleinsätzen
Avec plaquettes en carbure de tungstène
Tijeras de tungsteno

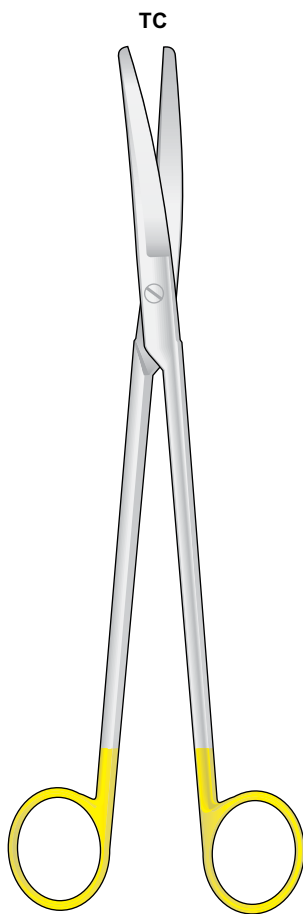

WERTHEIM

OS 278-01 / OS 278-02

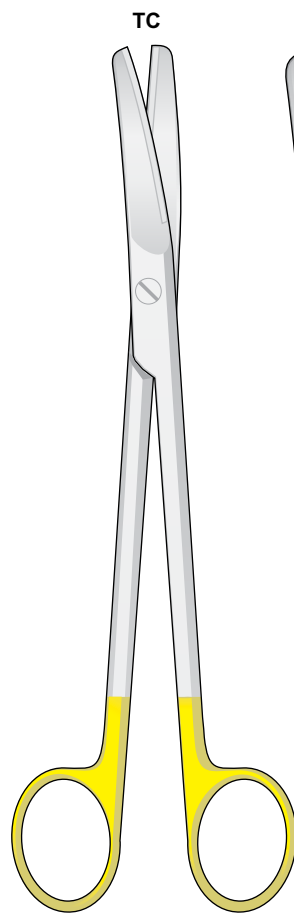

SIMS

79-01 / OS 279-02

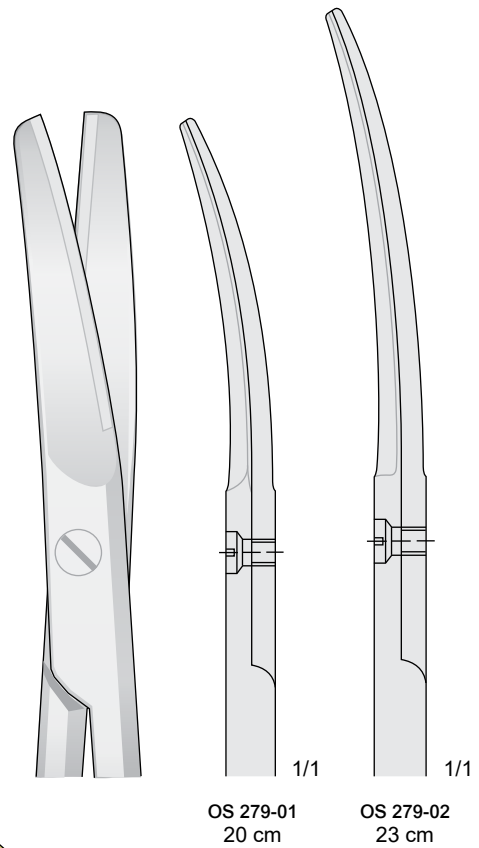

OS 279-01
20 cm

OS 279-02
23 cm

Forbici Wellenschliff
 Wellenschliff scissor
 Wellenschliff Schere
 Ciseaux Wellenschliff
 Tijeras Wellenschliff

Forbici con taglio ondulato su una lama
 Scissors cut one serrated cutting edge
 Scheren mit wellenschliff auf einer Schnittfläche
 Ciseaux avec affutage spécial ont une lame dentée

Forbici chirurgich
 Operating scissor
 Chirurgische Schere
 Ciseaux chirurgicau
 Tijeras para cirurgia general

Wellenschliff
 TC

Wellenschliff
 TC

Wellenschliff
 TC

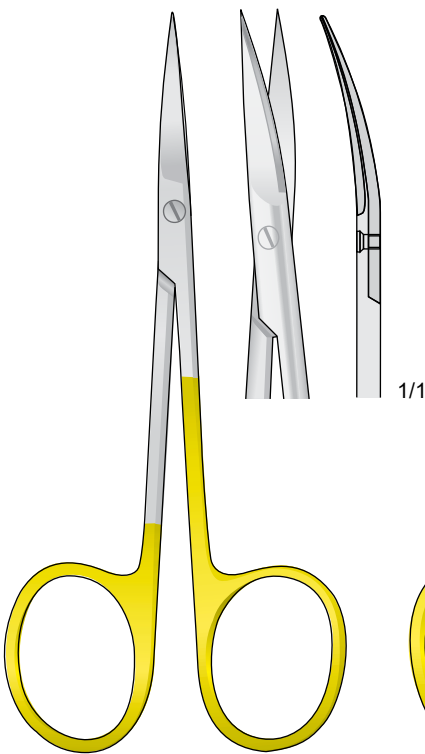

IRIS

WS 280-11 11 cm

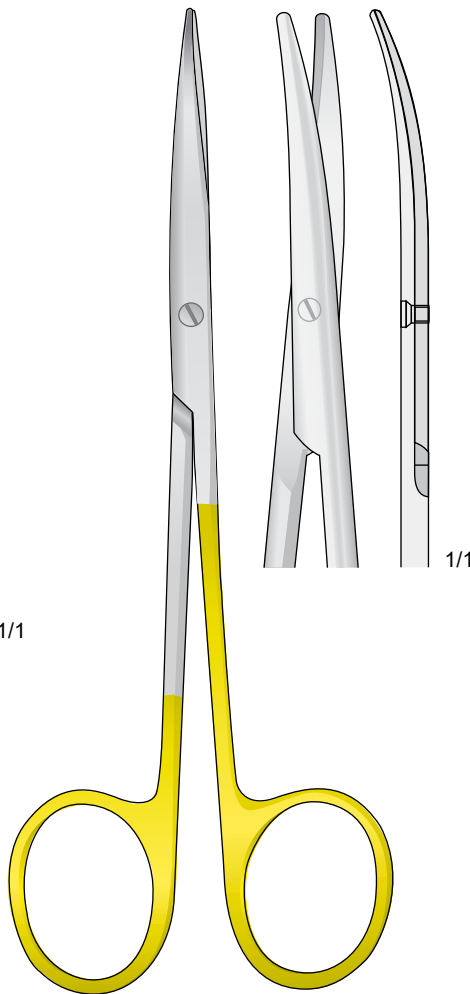

METZENBAUM

WS 281-14 14.5 cm

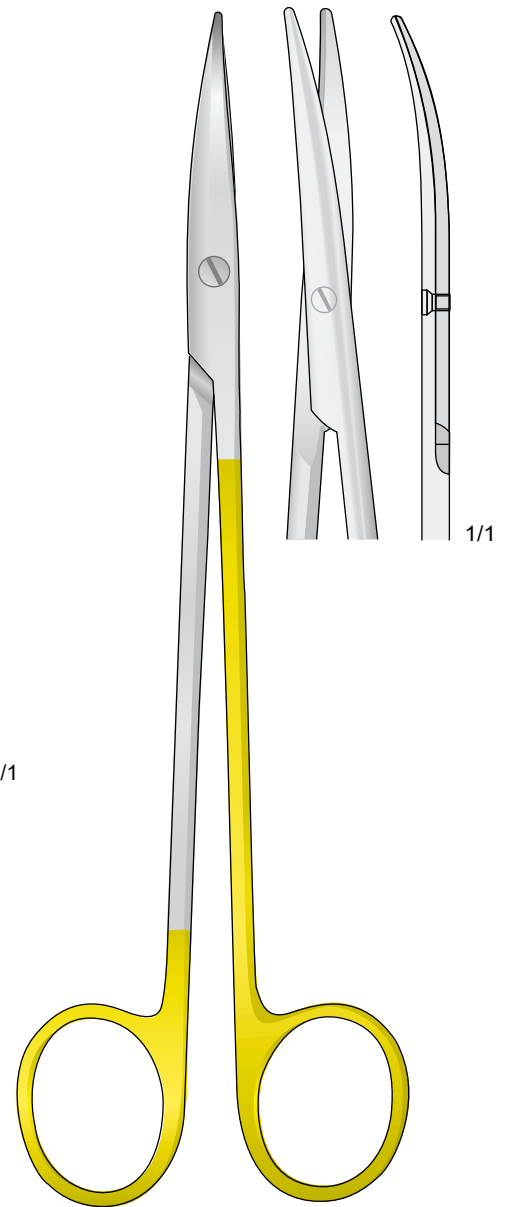

METZENBAUM

WS 282-18 18.5 cm

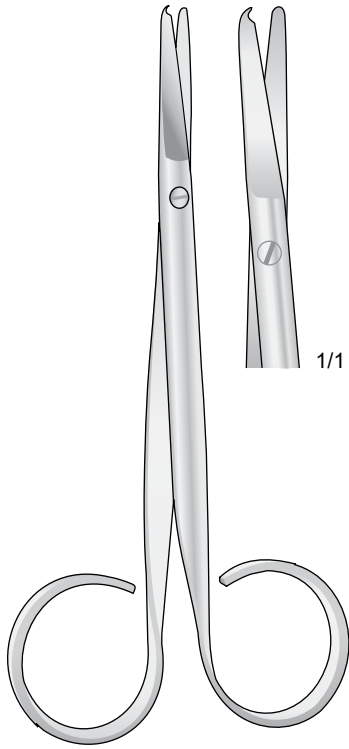

SPENCER
LS 283-11 11 cm

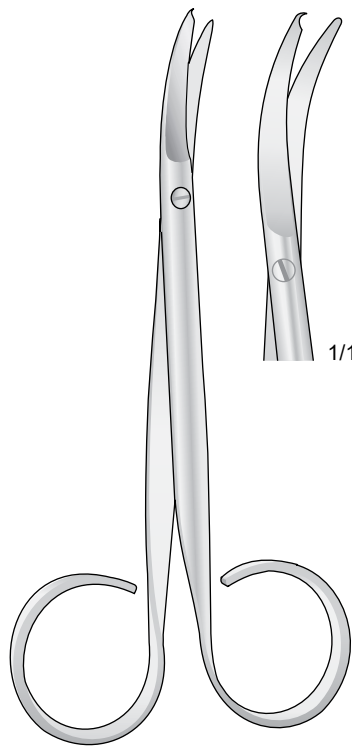

SPENCER
LS 284-11 11 cm

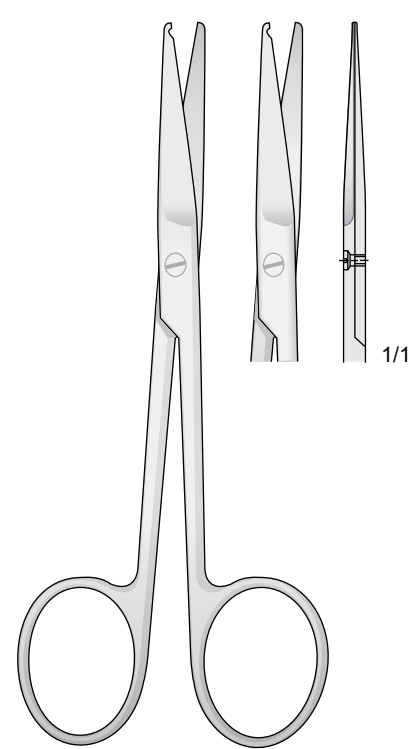

LS 285-11 11.5 cm

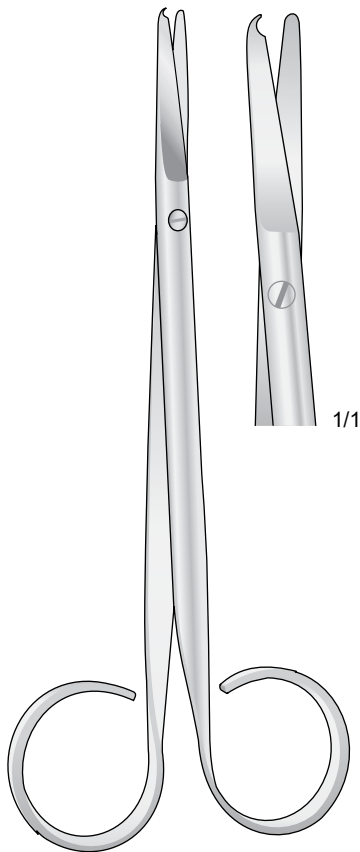

SPENCER
LS 286-14 14.5 cm

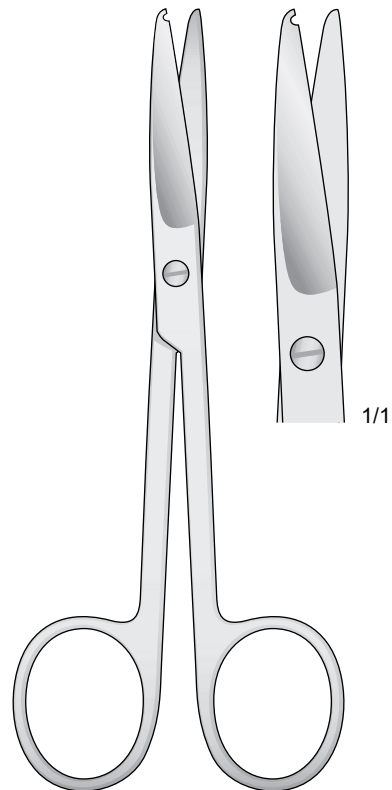

SPENCER
LS 287-13 13.5 cm

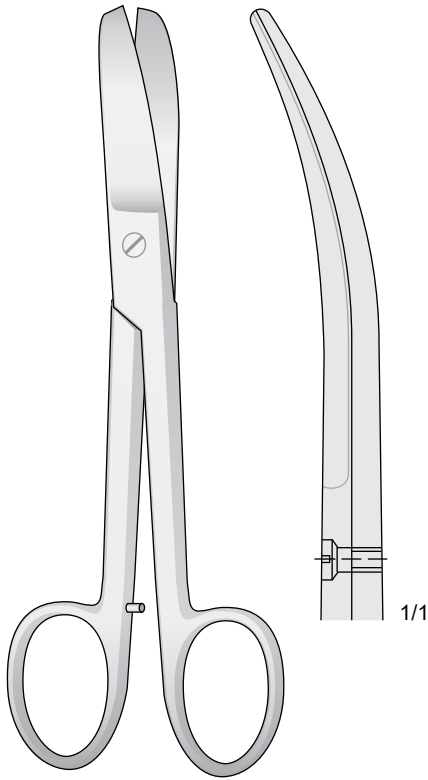

LORENZ

BS 288-23 23 cm



BRUNS

BS 289-24 24 cm

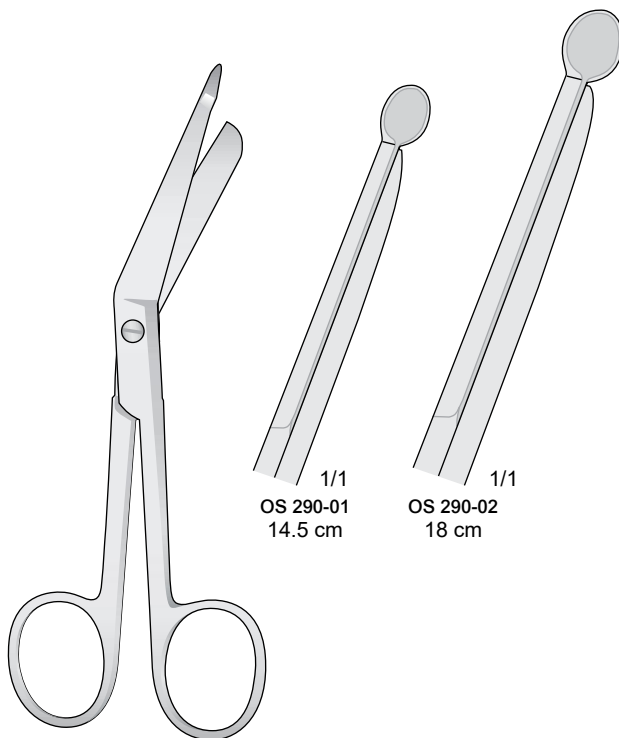

LISTER

BS 290-01 / BS 290-02

1/1
 OS 290-01
 14.5 cm

1/1
 OS 290-02
 18 cm

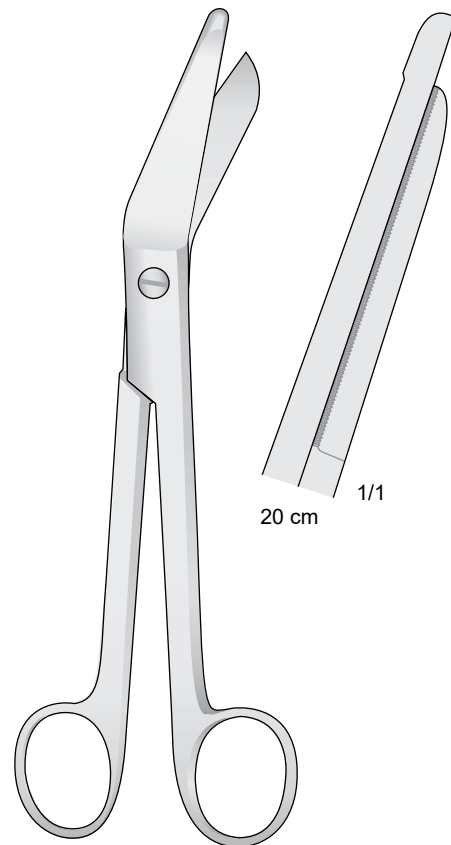

ESMARCH

BS 291-20 20 cm

Forbice universale dentellata
Draht-und Blehschere gezahnt
Wire cutting scissor serrated
Coupe-fils dentelés
Tijeras para cortar hilo de acero dentadas

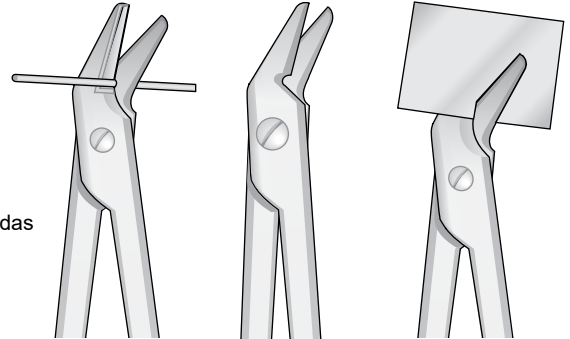

Con punta al carburo di tungsteno
Tungsten-carbide scissors
Mit Hartmetalleinsätzen
Avec plaquettes en carbure de tungstène
Tijeras de tungsteno

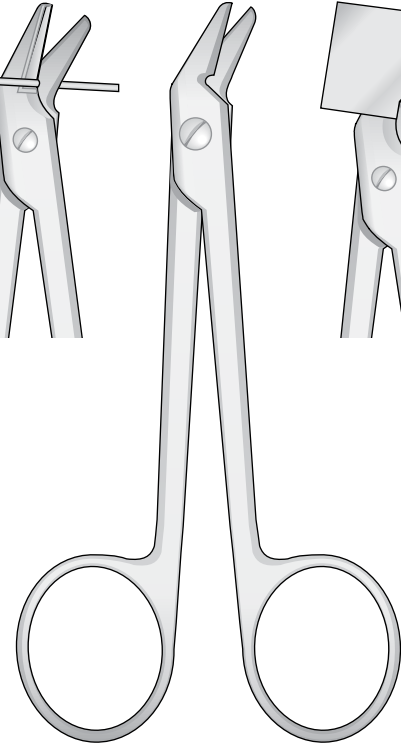

CS 292-12 12 cm

Wire Cutter
TC

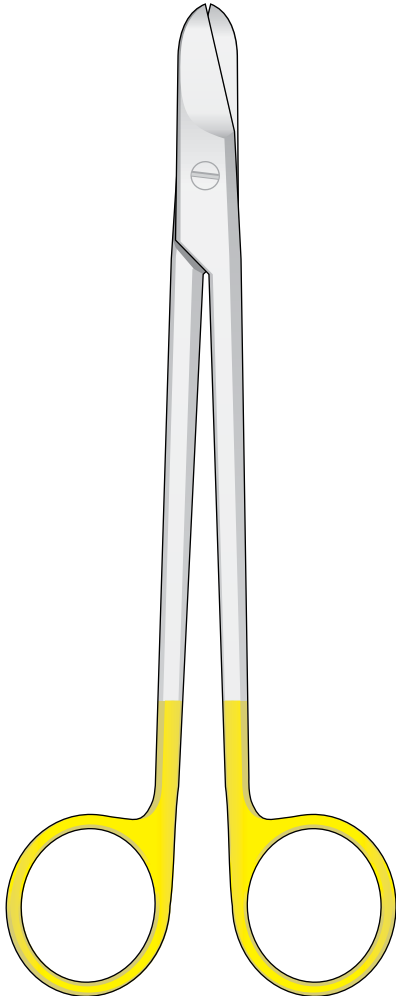

SMITH

CS 293-16 16 cm

Wire Cutter
TC

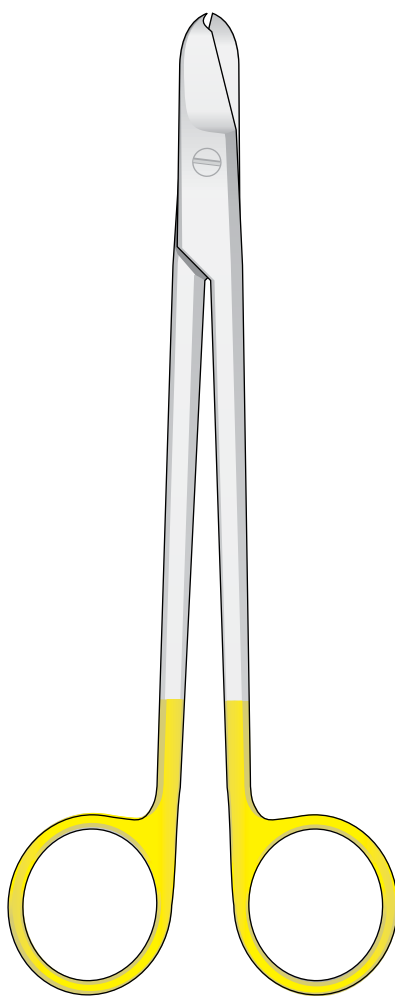

SMITH

CS 294-16 16 cm

TC

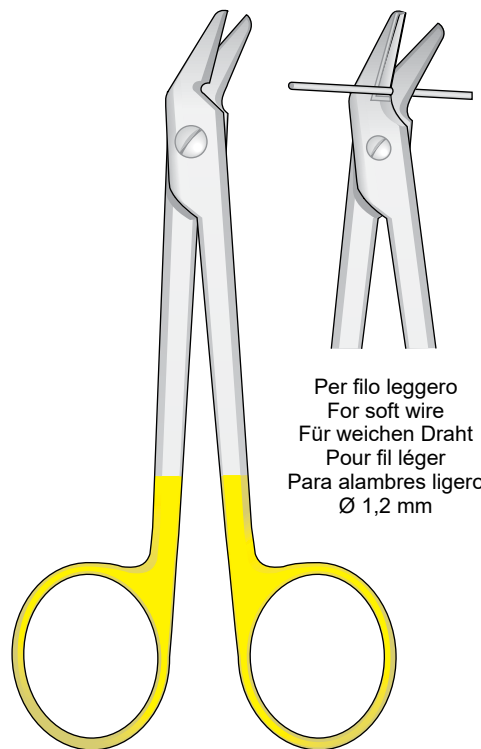

Per filo leggero
For soft wire
Für weichen Draht
Pour fil léger
Para alambres ligero
Ø 1,2 mm

CS 295-12 12 cm

Forbici per fili metallici
Wire and plate cutting scissors
Draht und Blehscheren
Ciseaux coupe-fils métalliques
Tijeras para cortar alambre

Smusse - Blunt - Stumpf - Musses - Romas

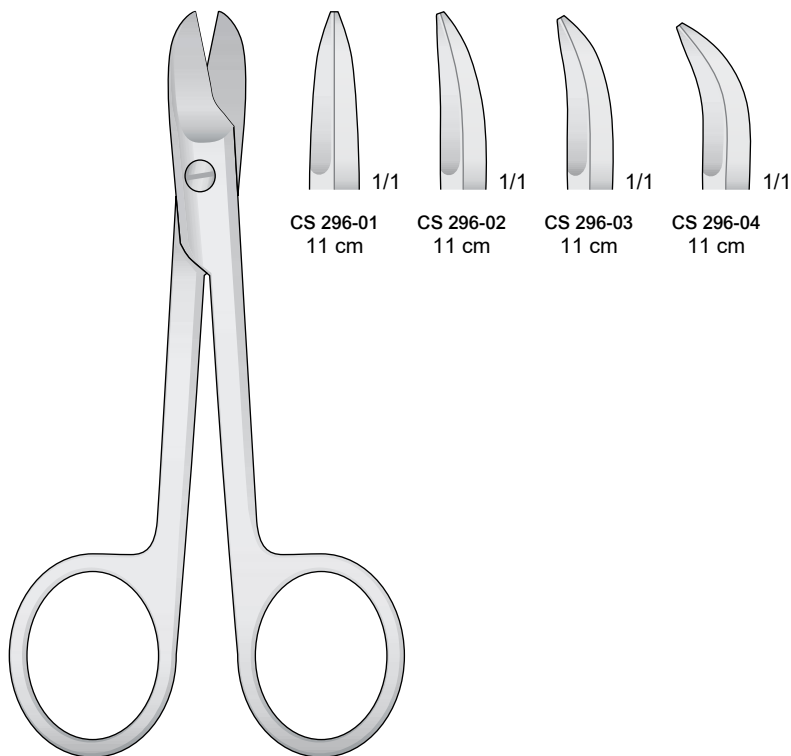

CS 296-01 1/1 11 cm
CS 296-02 1/1 11 cm
CS 296-03 1/1 11 cm
CS 296-04 1/1 11 cm

BEEBE

CS 296-01 / CS 296-04

Acute - Sharp - Spitz - Pointus - Agudas

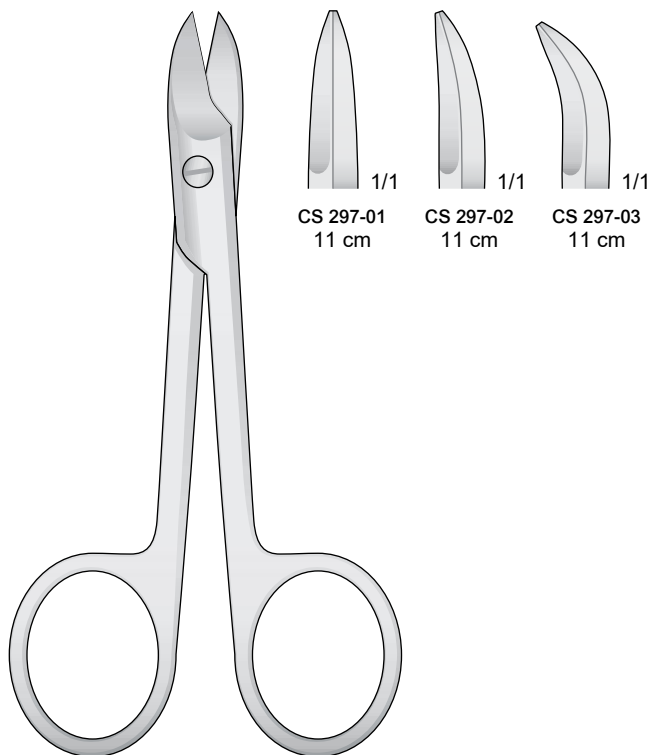

CS 297-01 1/1 11 cm
CS 297-02 1/1 11 cm
CS 297-03 1/1 11 cm

BEEBE

CS 297-01 / CS 297-03

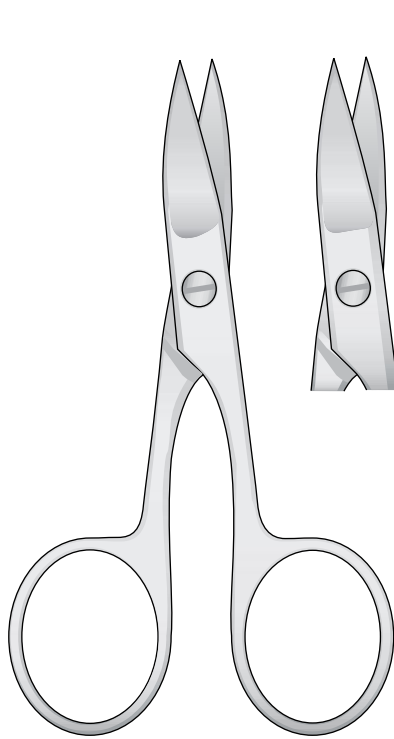

NS 298-01 / NS 298-04

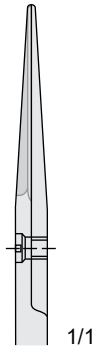

NS 298-01
09 cm

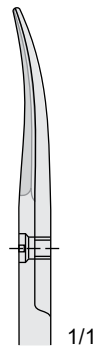

NS 298-02
09 cm

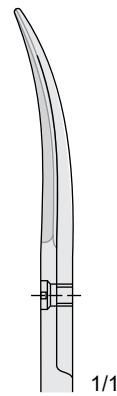

NS 298-03
10 cm

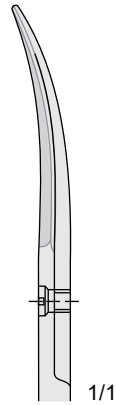

NS 298-04
11 cm

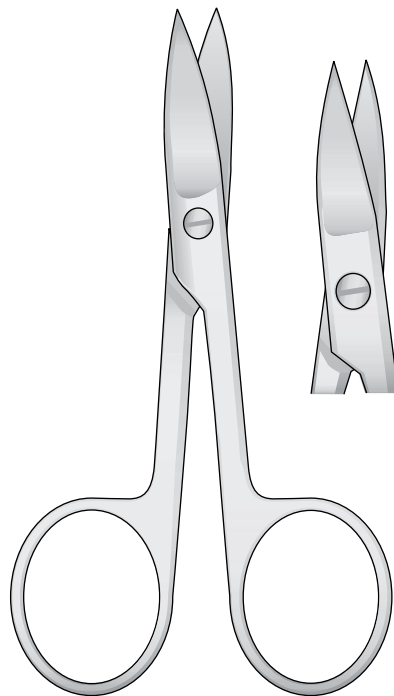

NS 299-01 / NS 299-04

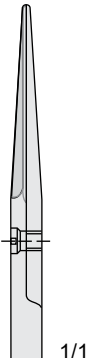

NS 299-01
9.5 cm

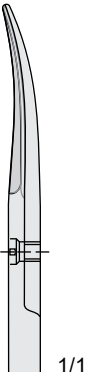

NS 299-02
9.5 cm

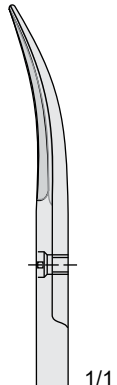

NS 299-03
10.5 cm



we take a *closer look*

Tissue and Dressing Forceps



we take a closer look



Chirurgische und Anatomische Pinzetten
Pincés à tissu et à pansement
Pinzas quirúrgicas y anatómicas
Pinzette chirurgiche e anatomiche

Micro pinzette
 Delicate forceps
 Micro Pinzetten
 Micro pincers
 Pinzas finos

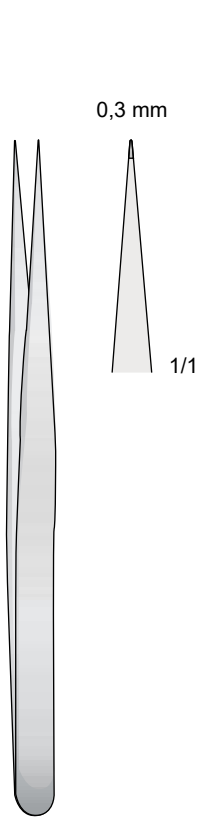

DF 300-12 12 cm

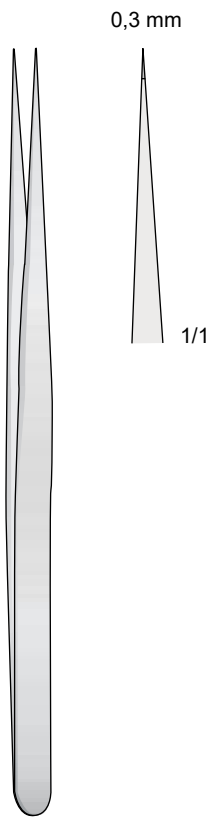

WISE
DF 301-13 13.5 cm

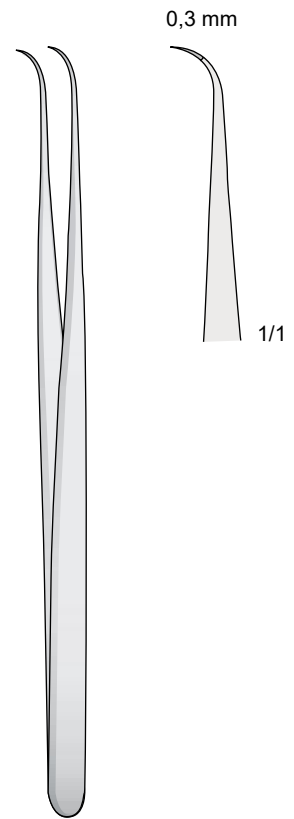

WISE
DF 302-13 13.5 cm

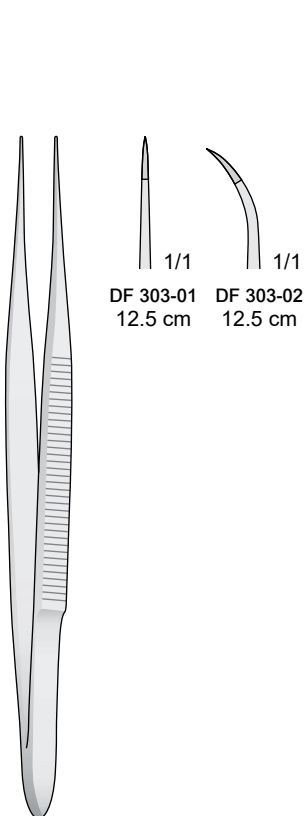

DF 303-01 / DF 303-02

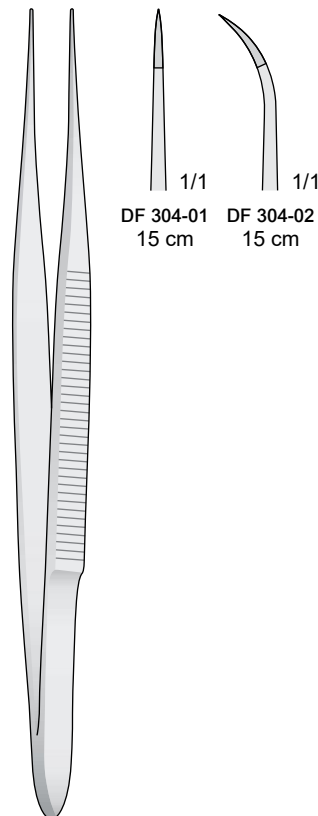

DF 304-01 / DF 304-02

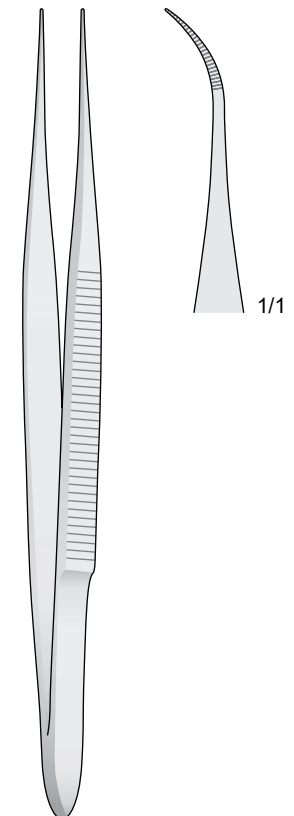

DF 305-15 15 cm



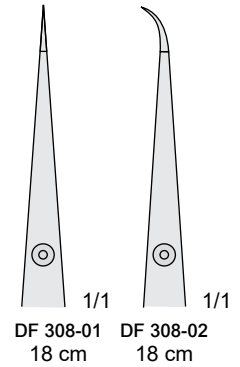
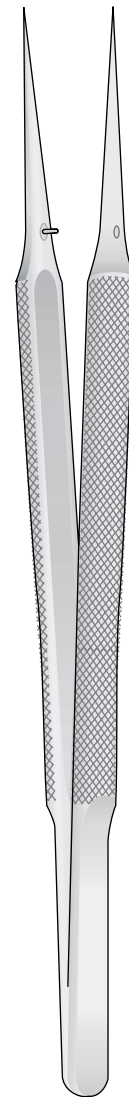
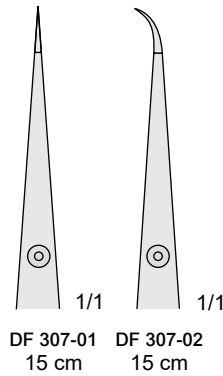
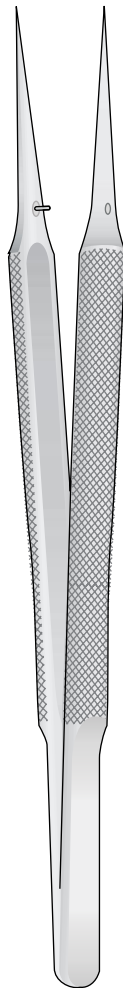
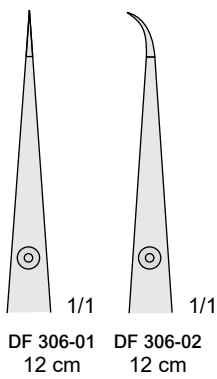
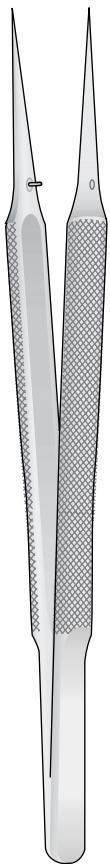

DF 306-01 / DF 306-02

DF 307-01 / DF 307-02

DF 308-01 / DF 308-02

Micro pinzette
Delicate forceps
Micro Pinzetten
Micro pincers
Pinzas finos

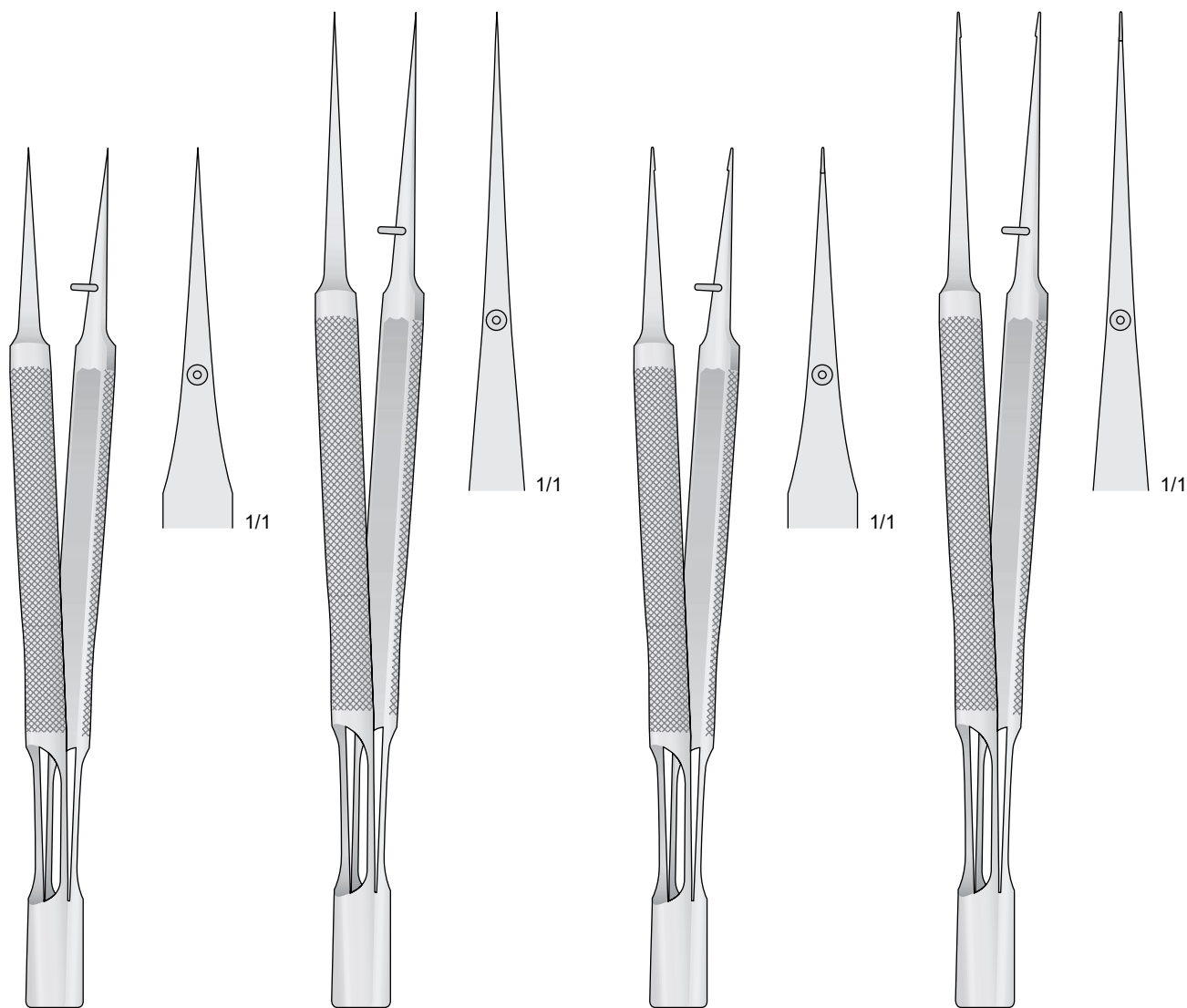
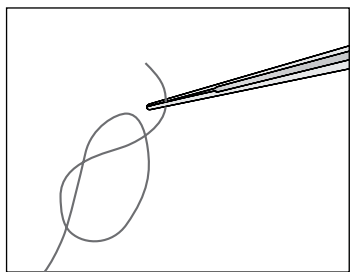

BROCK
DF 309-13 13 cm

BROCK
DF 310-15 15 cm

BROCK
DF 311-13 13 cm

BROCK
DF 312-15 15 cm



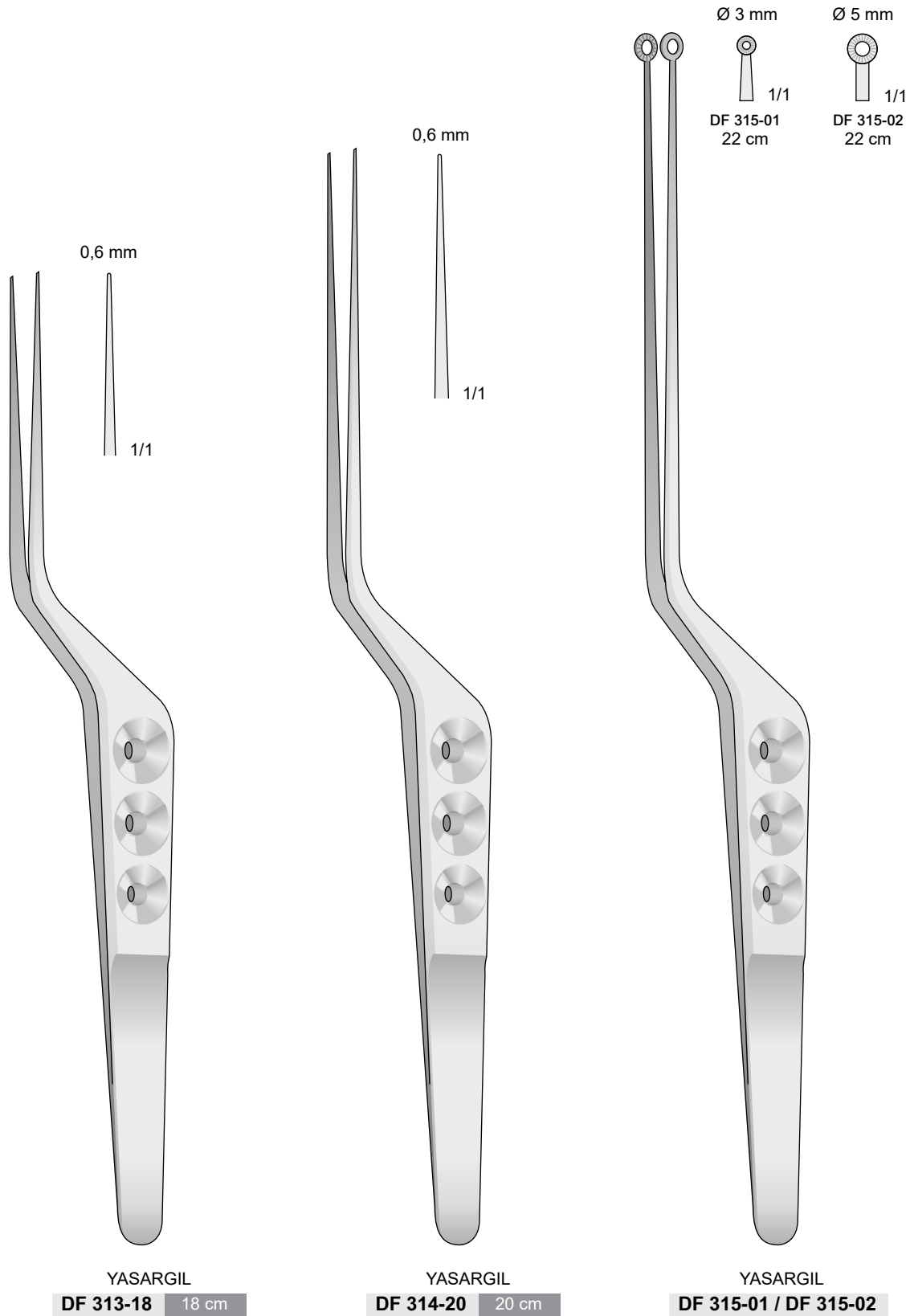

Micro pinzette
 Delicate forceps
 Micro Pinzetten
 Micro pincers
 Pinzas finos

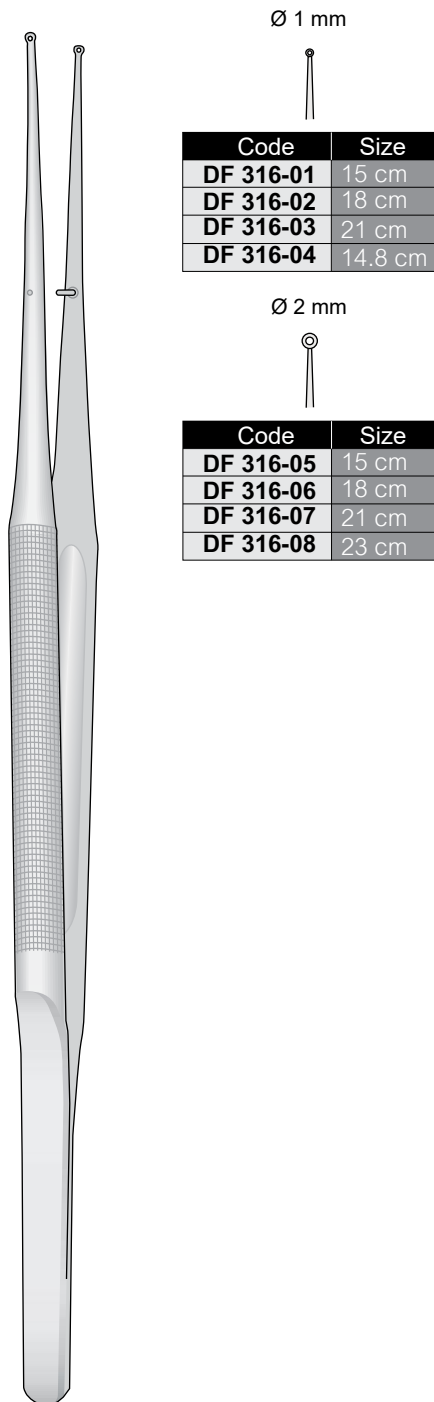

DF 316-01 / DF 316-08

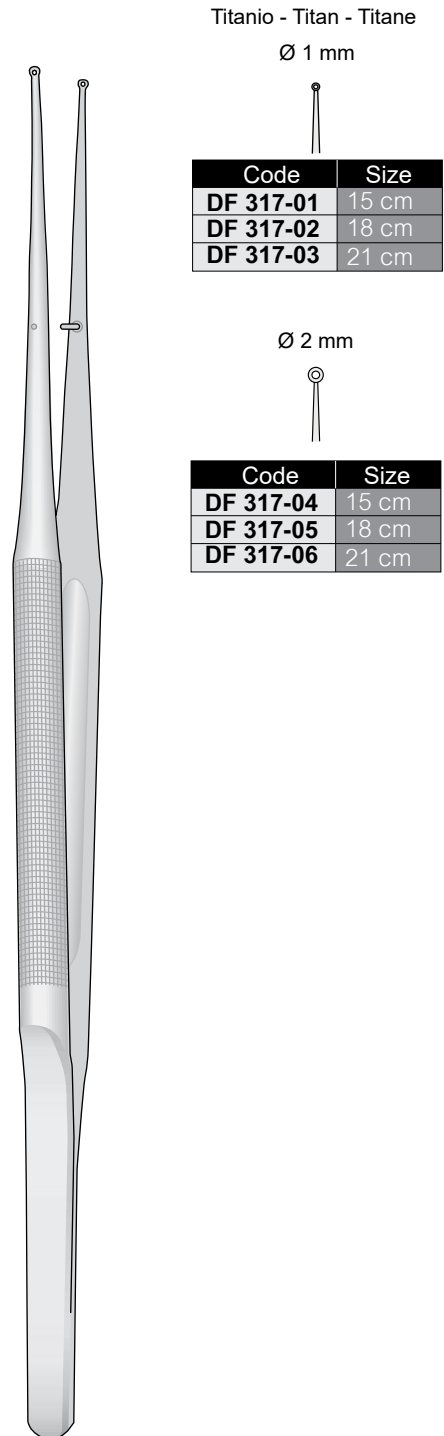

DF 317-01 / DF 317-06

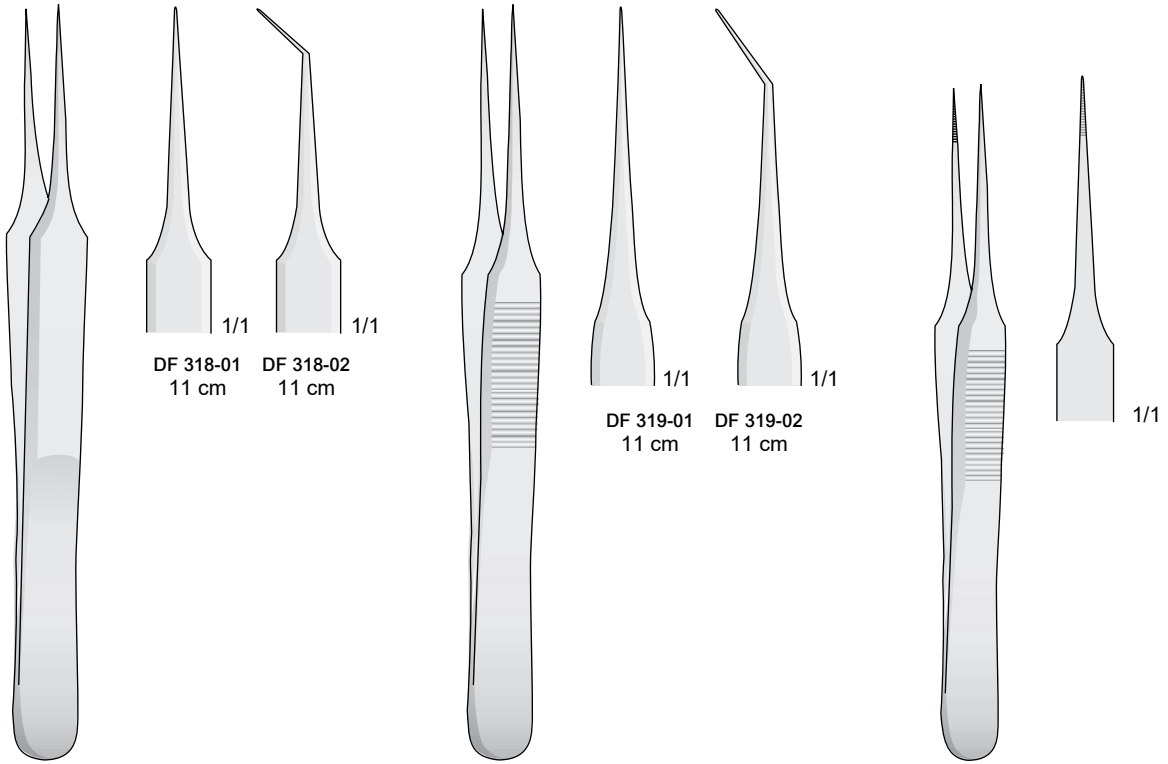

DF 318-01 / DF 318-02

DF 319-01 / DF 319-02

DF 320-9 9 cm

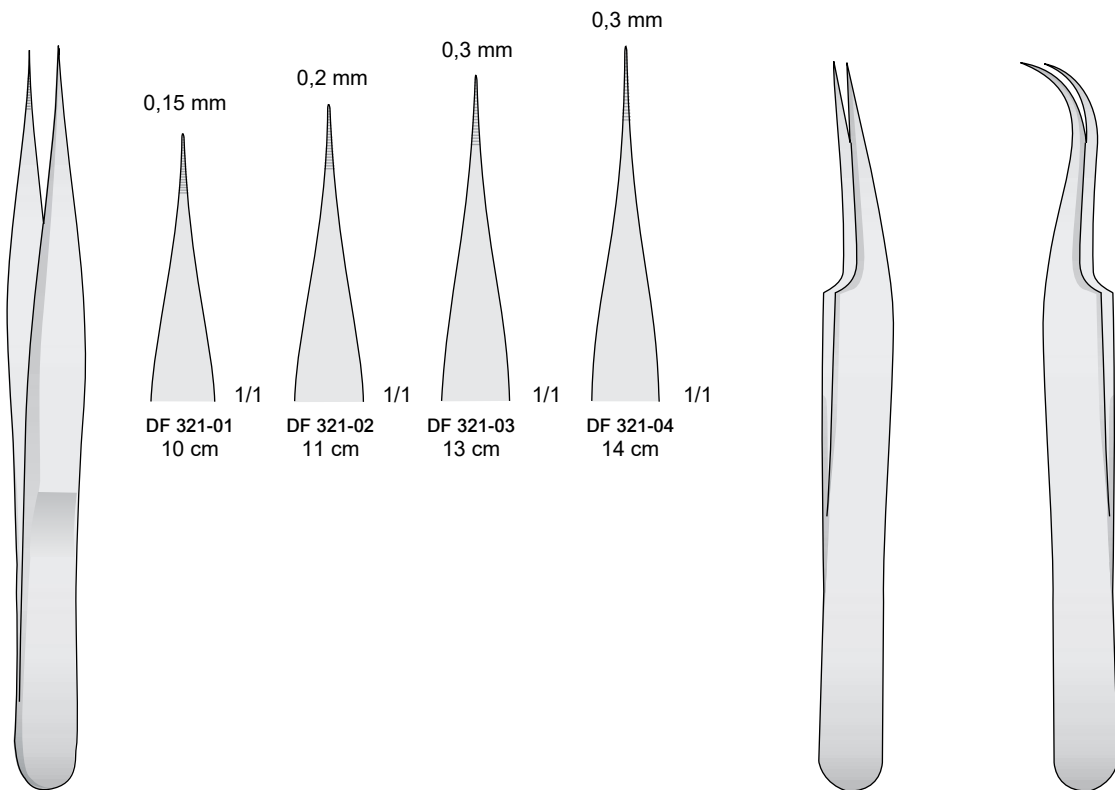

DF 321-01 / DF 321-04

DF 322-11 11.5 cm

DF 323-11 11.5 cm

Pinze per dissezion
 Thumb and tissue forcep
 Pinzette
 Pincés à dissecctio
 Pinzas de disección

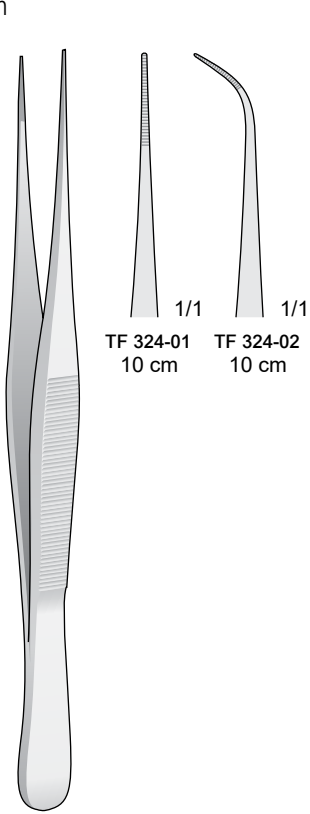

TF 324-01 / TF 324-02

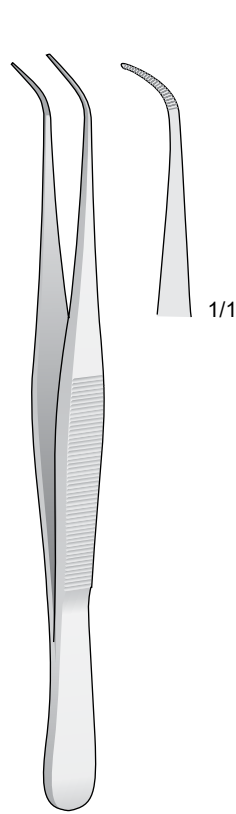

TF 325-10 10 cm

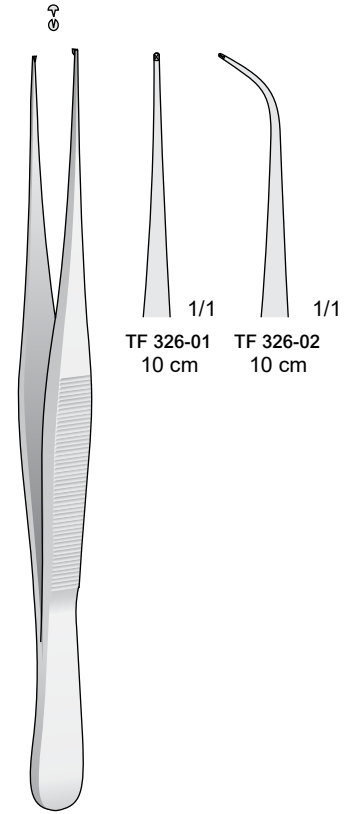

TF 326-01 / TF 326-02

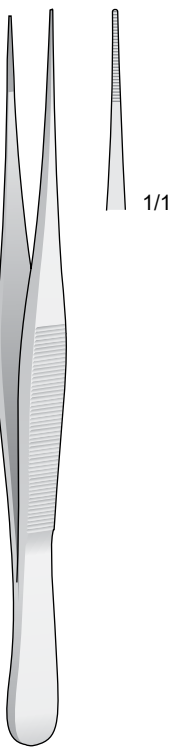

TF 327-11 11 cm

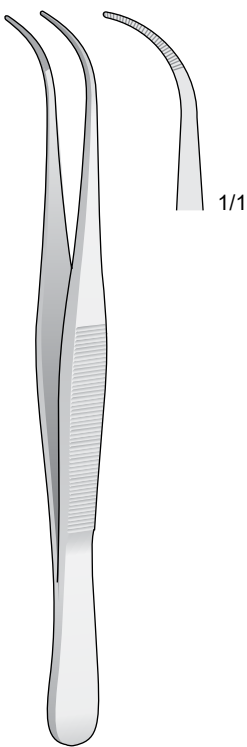

TF 328-11 11 cm

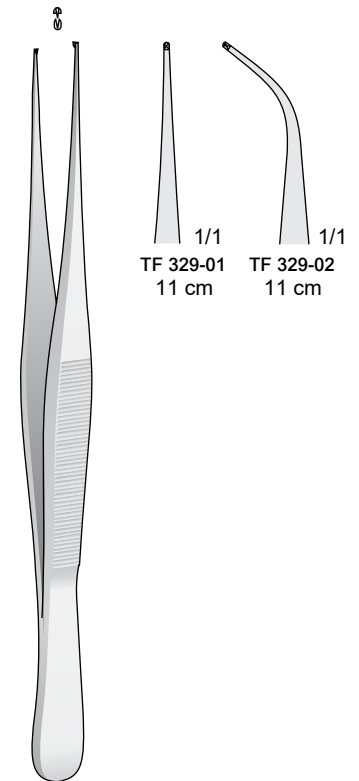

TF 329-01 / TF 329-02

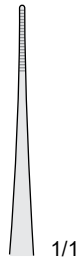

TF 330-01
10 cm

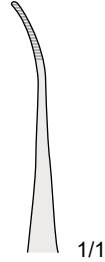

TF 330-02
10 cm

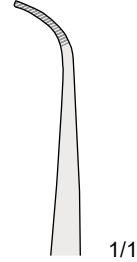

TF 330-03
10 cm

GRAEFE

TF 330-01 / TF 330-03

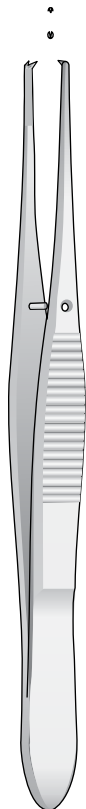

TF 331-01
10 cm



TF 331-02
10 cm

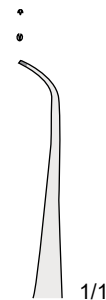

TF 331-03
10 cm

GRAEFE

TF 331-01 / TF 331-03

Pinzette chirurgich
 Tissue forcep
 Chirurgische pinzette
 Pincas chirurgicale
 Pinzas chirùrgicas

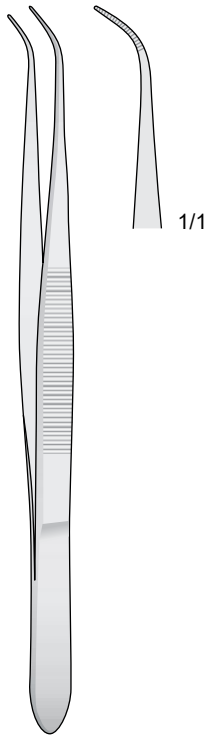

PERRY

TF 332-12 12.5 cm

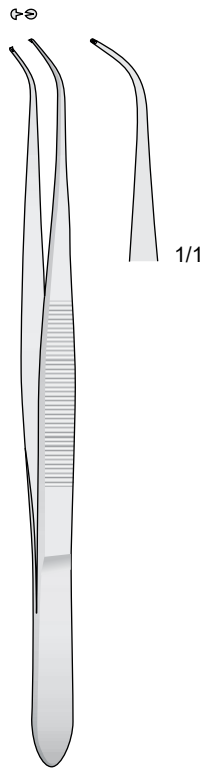

PERRY

TF 333-12 12.5 cm



TF 334-01 / TF 334-02

1x2 denti
 0,2 mm



TF 334.01
 9.5 cm

0,8 mm

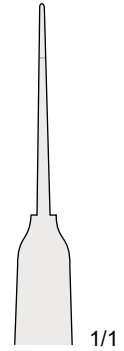

AUSTIN
 TF 334.02
 14 cm

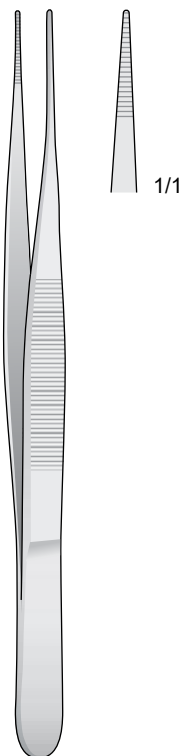

TF 335-13 13 cm

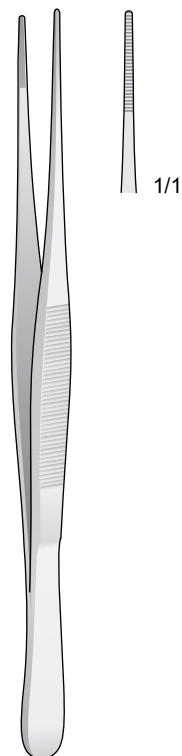

SEMKEN
TF 336-13 13 cm

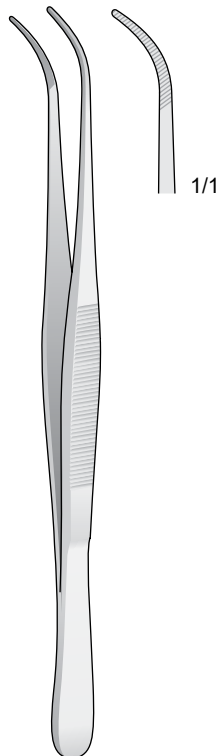

SEMKEN
TF 337-13 13 cm

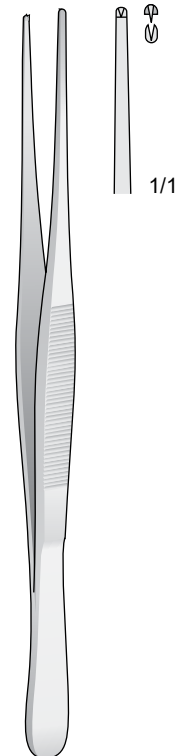

SEMKEN
TF 338-13 13 cm

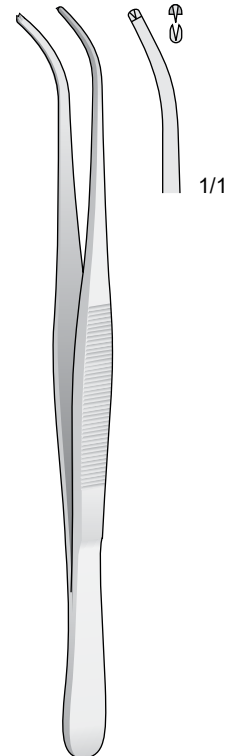

SEMKEN
TF 339-13 13 cm



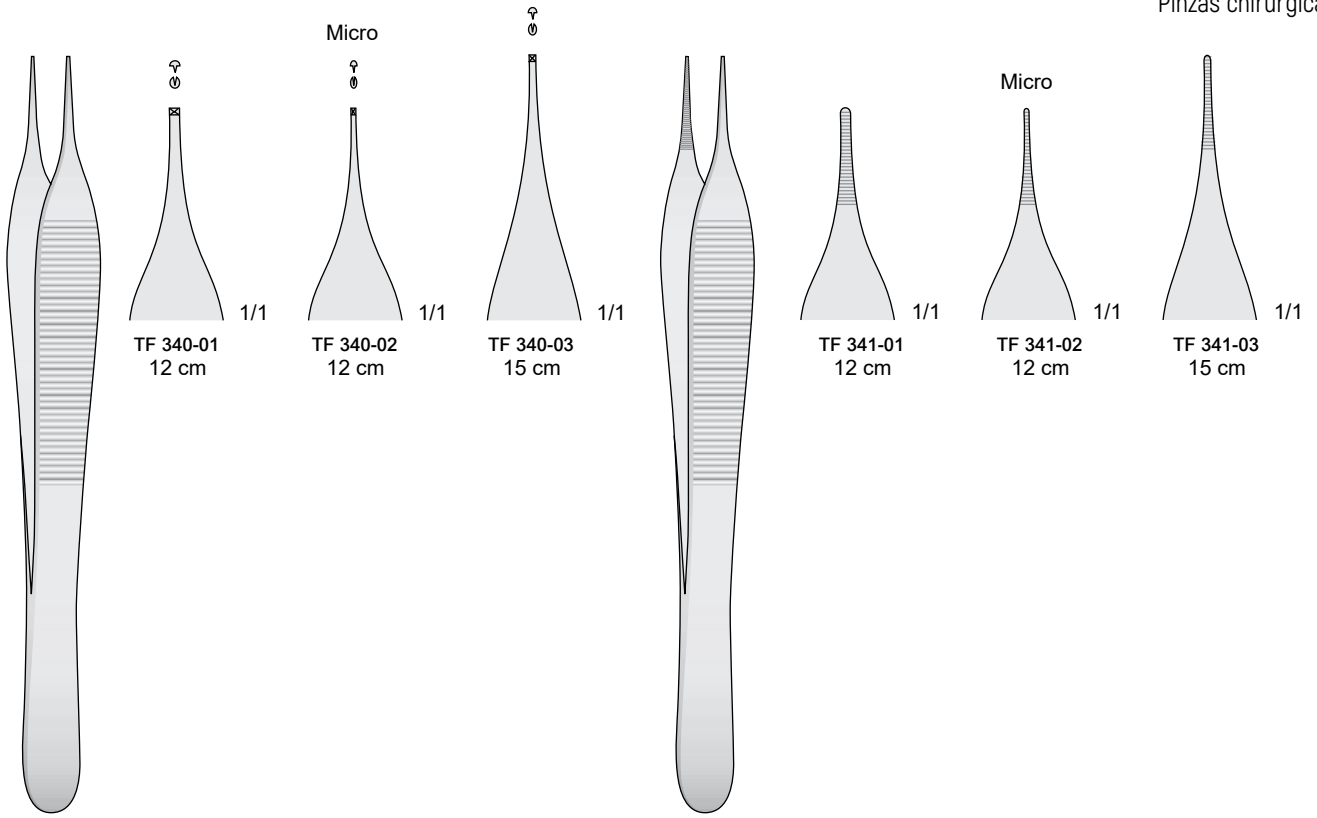

ADSON

TF 340-01 / TF 340-03

ADSON

TF 341-01 / TF 341-03

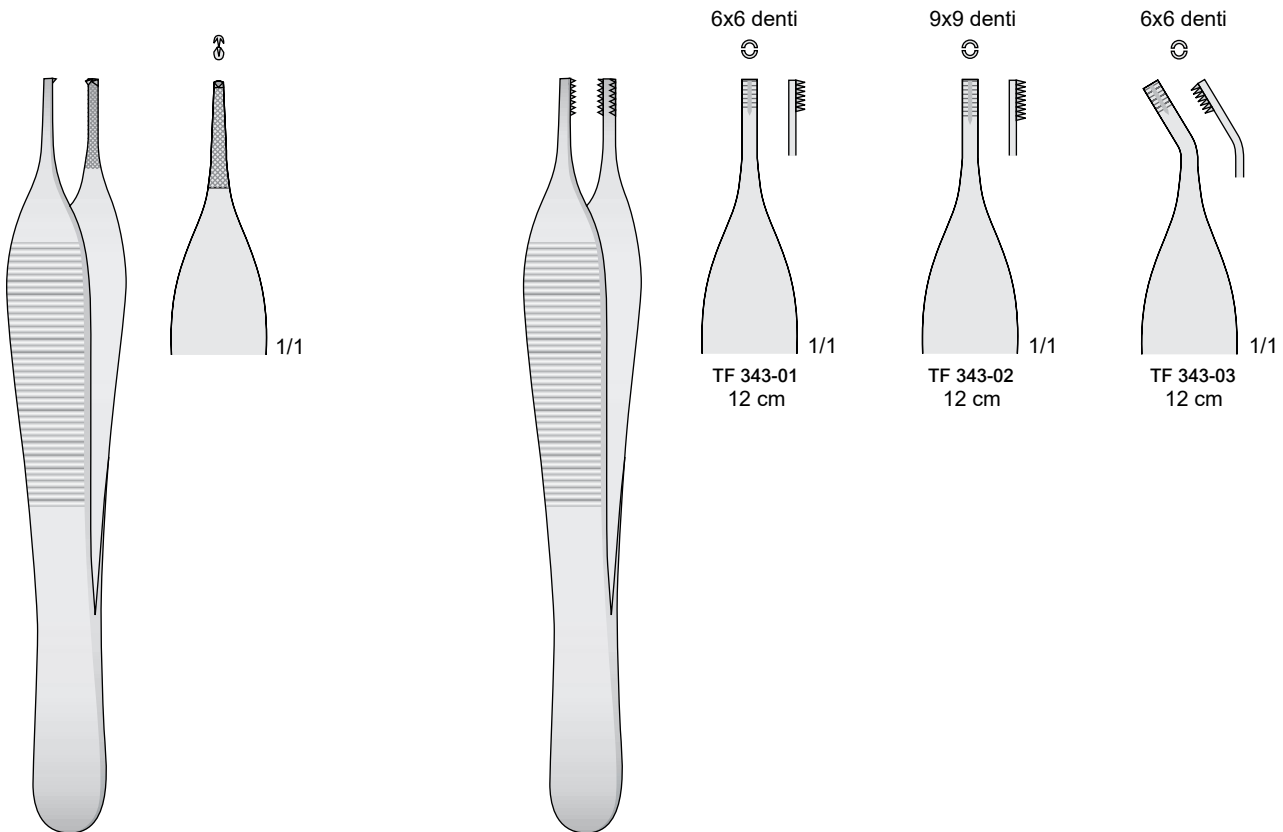

ADSON

TF 342-12 12 cm

ADSON-BROWN

TF 343-01 / TF 343-03

Pinzette anatomic
 Dressing forcep
 Anatomische Pinzette
 Pincers anatomique
 Pinzas de diseccion

Standard

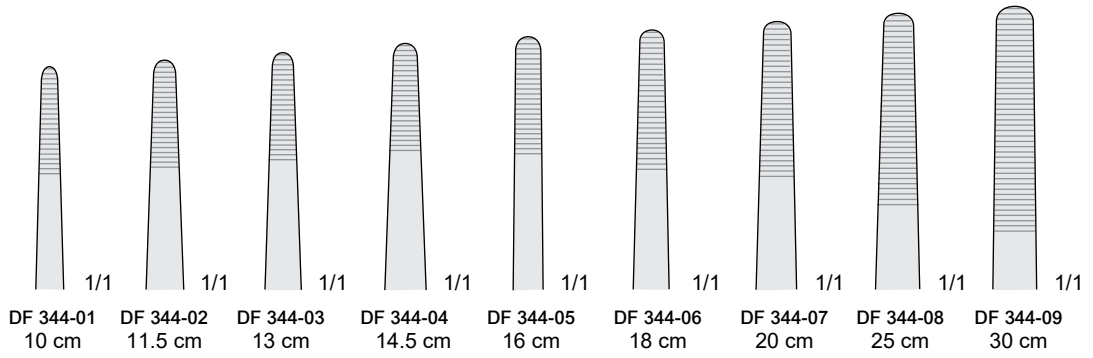

DF 344-01 / DF 344-09

Mod. Fine

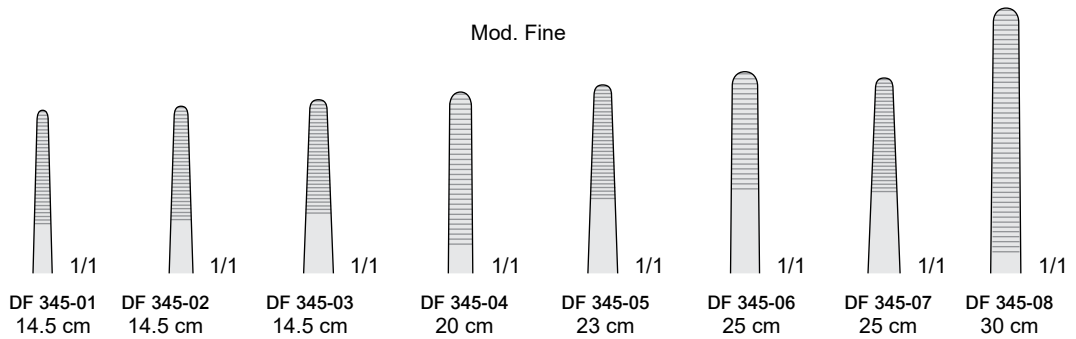

DF 345-01 / DF 345-08



STILLE

DF 346-01 / DF 346-04

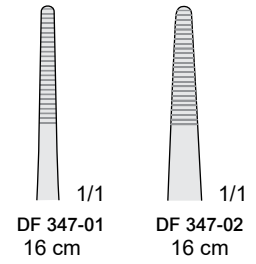
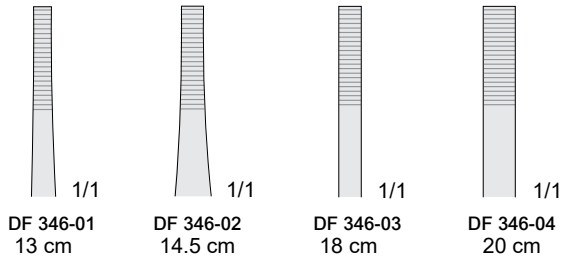

DF 347-01 / DF 347-02



DF 348-01 / DF 348-10

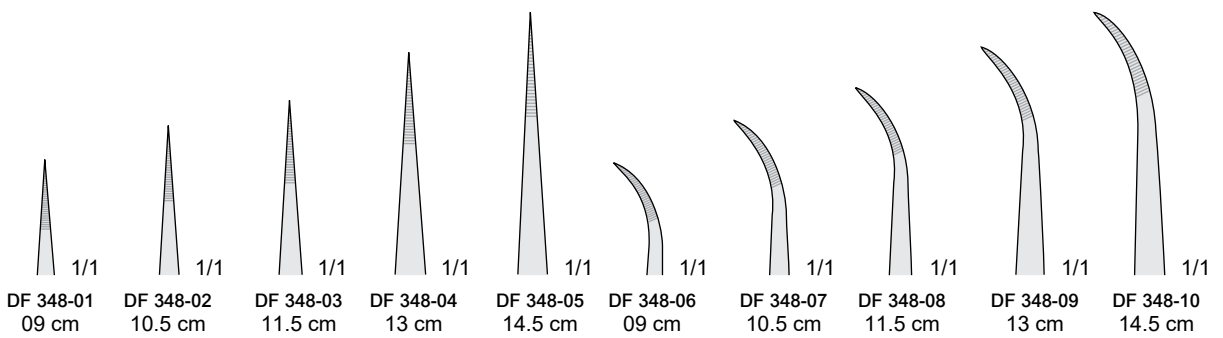

1 x 2 Denti - 1 x 2 Teeth - 1 x 2 Zähne - 1 x 2 Dents - 1 x 2 Dientes



Standard

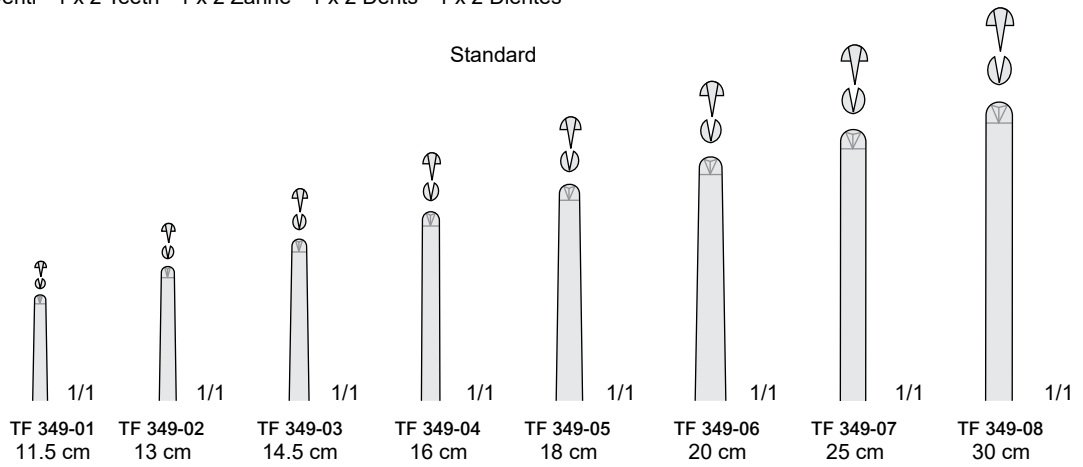

TF 349-01 / TF 349-08

1 x 2 Denti - 1 x 2 Teeth - 1 x 2 Zähne - 1 x 2 Dents - 1 x 2 Dientes



Strette - Schmal - Narrow - Étroites - Estrechas

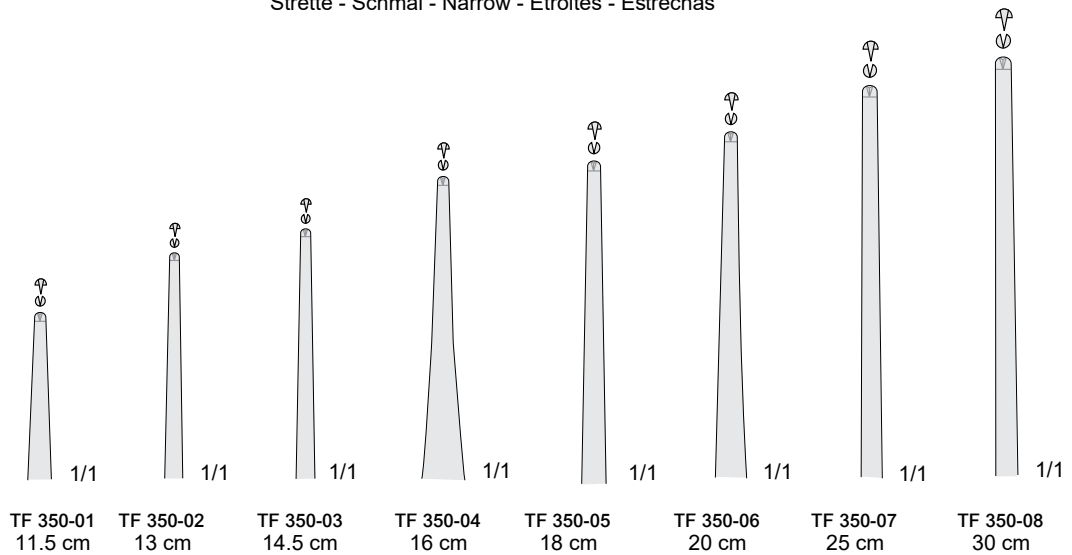

TF 350-01 / TF 350-08

Strette - Schmal - Narrow - Étroites - Estrechas

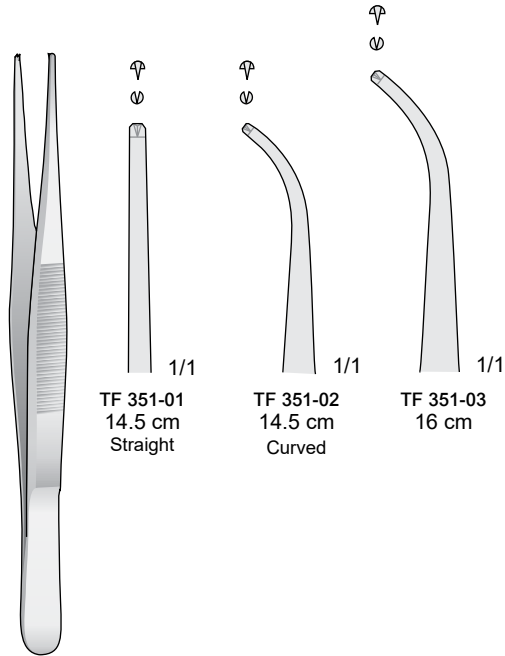

TF 351-01
14.5 cm
Straight

TF 351-02
14.5 cm
Curved

TF 351-03
16 cm

Fine - Delicate - Fein - Fines - Finas

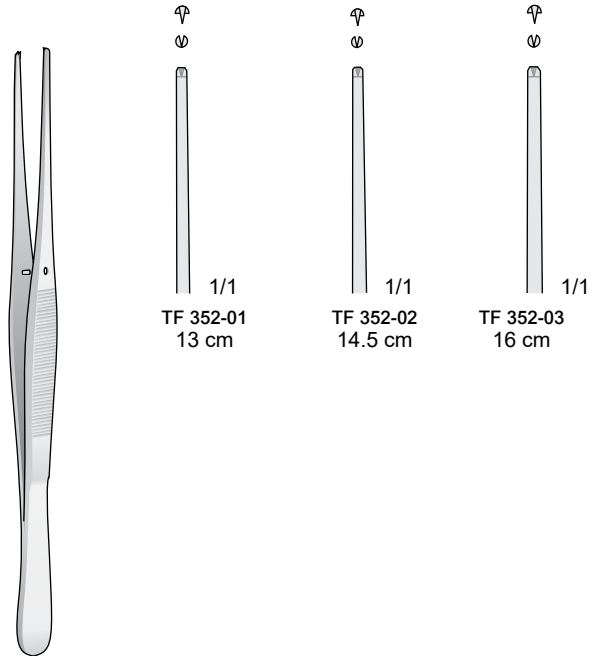

TF 352-01
13 cm

TF 352-02
14.5 cm

TF 352-03
16 cm

TF 351-01 / TF 351-03

TF 352-01 / TF 352-03

1 x 2 Denti
1 x 2 Teeth
1 x 2 Zähne
1 x 2 Dents
1 x 2 Dientes

1 x 2 Denti
1 x 2 Teeth
1 x 2 Zähne
1 x 2 Dents
1 x 2 Dientes

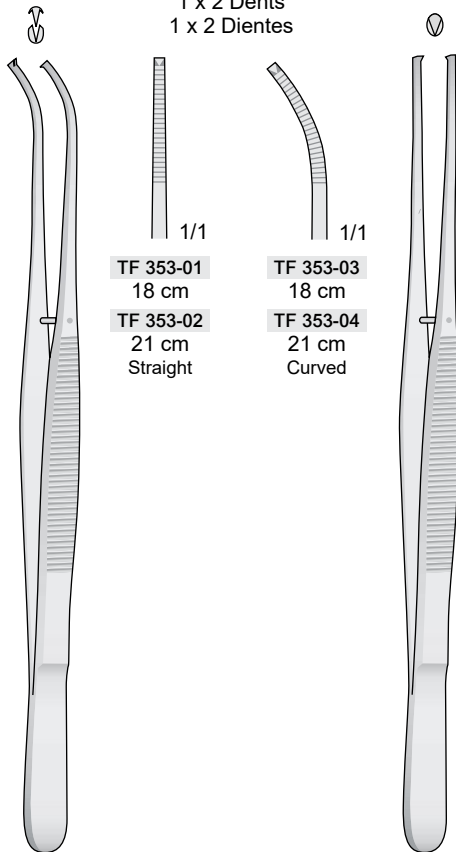

TF 353-01
18 cm

TF 353-03
18 cm

TF 353-02
21 cm
Straight

TF 353-04
21 cm
Curved

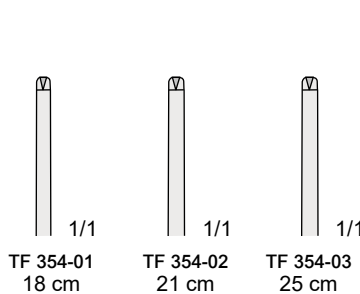

TF 354-01
18 cm

TF 354-02
21 cm

TF 354-03
25 cm

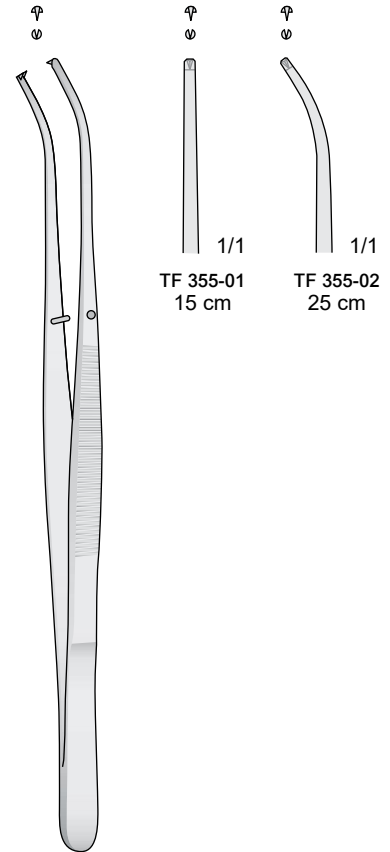

TF 355-01
15 cm

TF 355-02
25 cm

POTTS-SMITH

POTTS-SMITH

SEMKEN

TF 353-01 / TF 353-04

TF 354-01 / TF 354-03

TF 355-01 / TF 355-02

Pinzette chirurgisch
 Tissue forcep
 Chirurgische pinzette
 Pincés chirurgicale
 Pinzas chirùrgicas

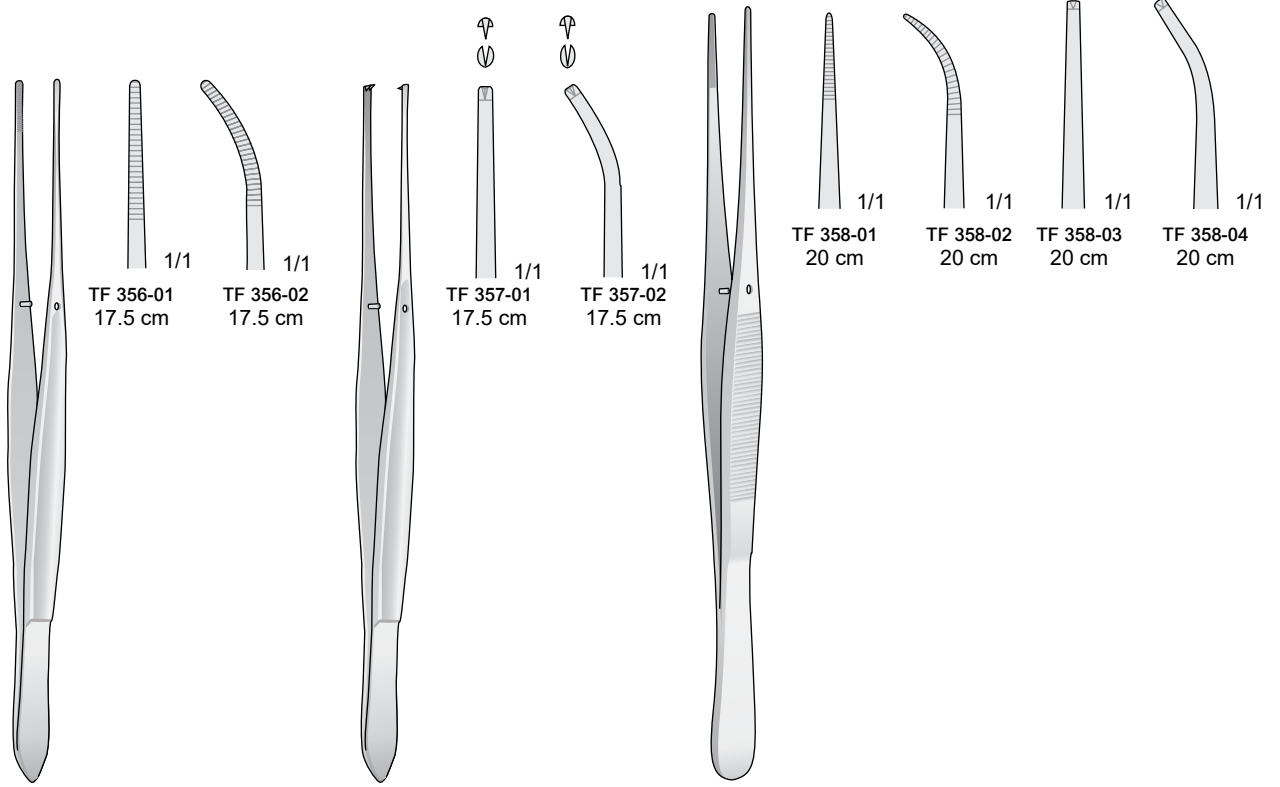

CUSHING

TF 356-01 / TF 356-02

CUSHING

TF 357-01 / TF 357-02

TF 358-01 / TF 358-04

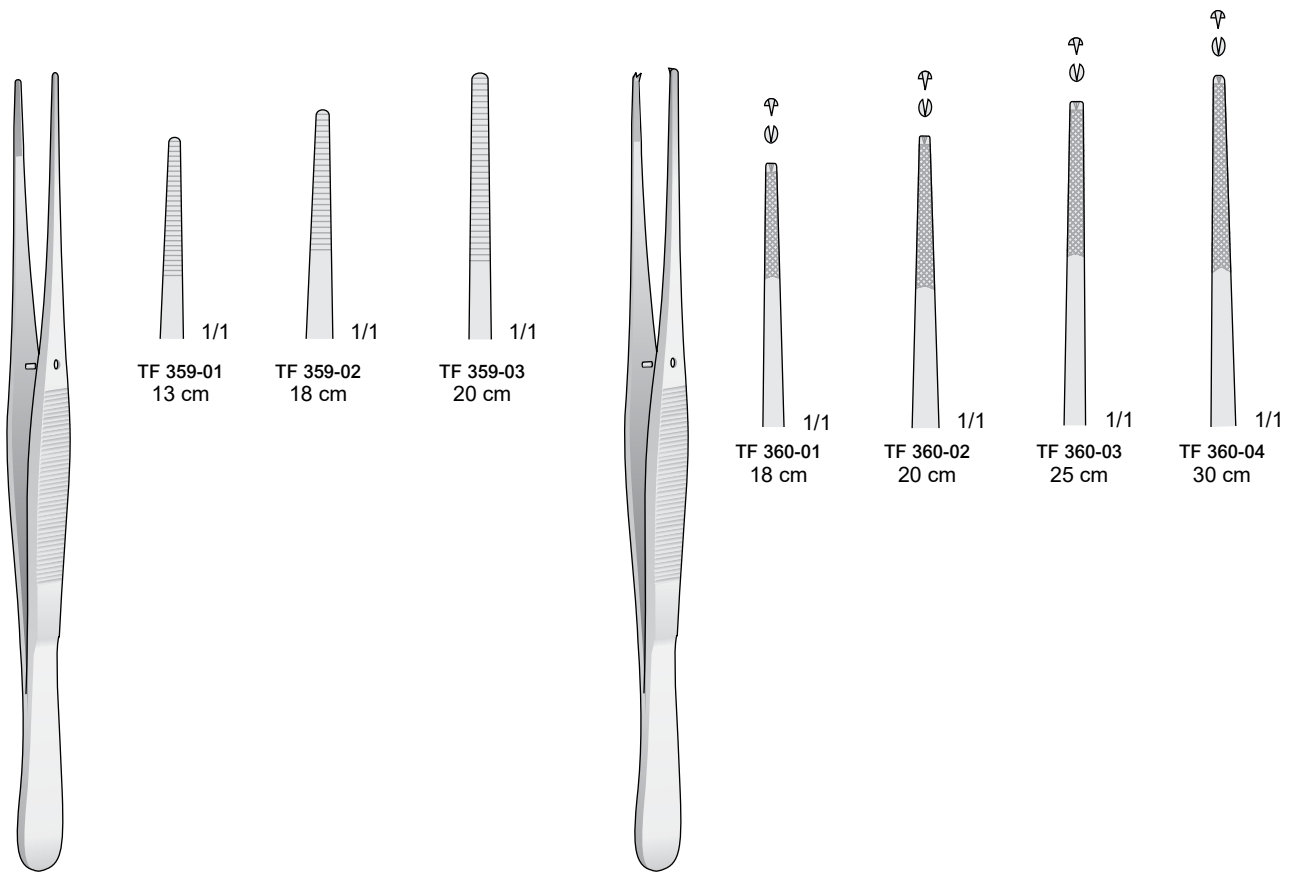

TF 359-01 / TF 359-03

TF 360-01 / TF 360-04



2 x 3 Denti - 2 x 3 Teeth - 2 x 3 Zähne
2 x 3 Dents - 2 x 3 Dientes

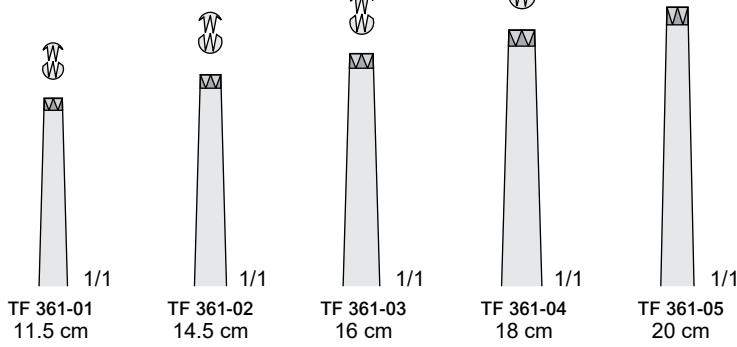

TF 361-01 / TF 361-05

3 x 4 Denti - 3 x 4 Teeth - 3 x 4 Zähne
3 x 4 Dents - 3 x 4 Dientes

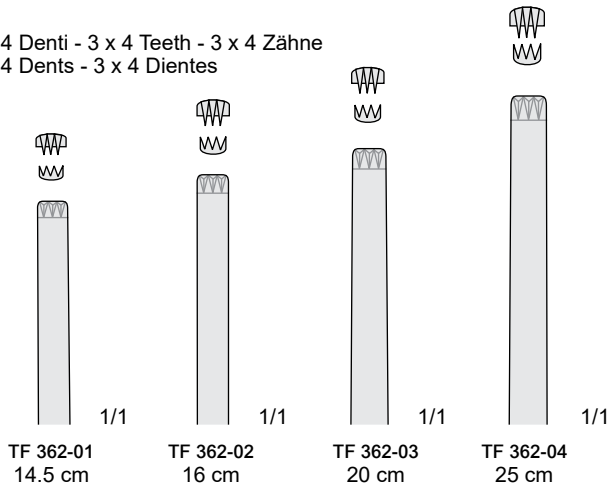

TF 362-01 / TF 362-04

4 x 5 Denti
4 x 5 Teeth
4 x 5 Zähne
4 x 5 Dents
4 x 5 Dientes

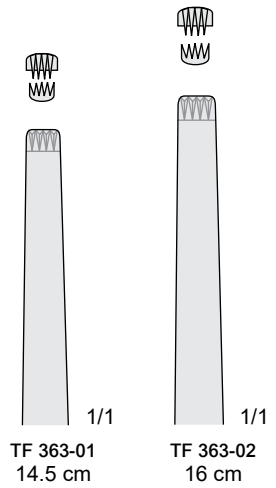

TF 363-01 / TF 363-02

Pinzette chirurgisch
 Tissue forcep
 Chirurgische pinzette
 Pincers chirurgicale
 Pinzas quirúrgicas

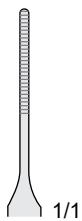

1/1

GERALD

TF 364-18 18 cm

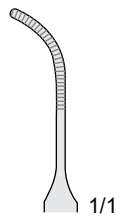
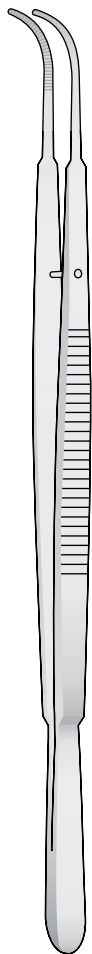

1/1

GERALD

TF 365-18 18 cm

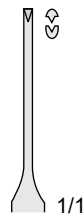

1/1

GERALD

TF 366-18 18 cm

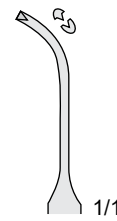
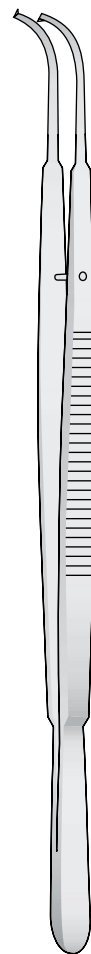

1/1

GERALD

TF 367-18 18 cm

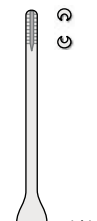

1/1

GERALD-BROWN

TF 368-18 18 cm



Pinzette per vasi e per tumori
Pinces vasculaires et pour tumeurs

3 x 4 Denti
3 x 4 Teeth
3 x 4 Zähne
3 x 4 Dents
3 x 4 Dientes

4 x 5 Denti
4 x 5 Teeth
4 x 5 Zähne
4 x 5 Dents
4 x 5 Dientes

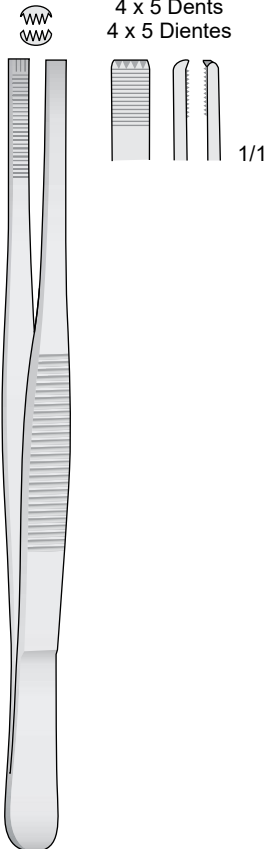

2 x 3 Denti
2 x 3 Teeth
2 x 3 Zähne
2 x 3 Dents
2 x 3 Dientes

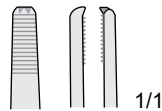

TF 371-01
18 cm

TF 371-02
20 cm

TF 371-03
25 cm

ADLERKREUTZ

TF 369-15	15 cm
TF 369-20	20 cm
TF 369-25	25 cm

ADLERKREUTZ

TF 370-15	15 cm
TF 370-20	20 cm

STILLE-BARRAYA

TF 371-01 / TF 371-03

Pinzette anatomic
 Dressing forcep
 Anatomische Pinzette
 Pincers Anatomique
 Pinzas de diseccion

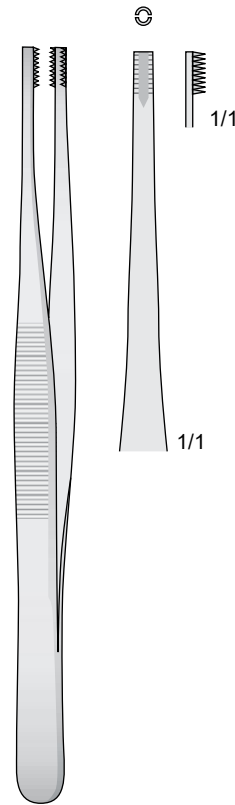
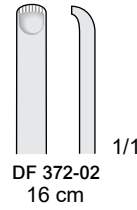
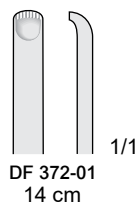

8 x 8 Denti
 8 x 8 Teeth
 8 x 8 Zähne
 8 x 8 Dents
 8 x 8 Dientes

DURANTE
 DF 372-01 / TF 372-02

BROWN
 DF 373-15 15 cm

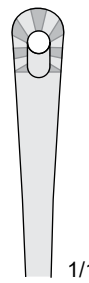
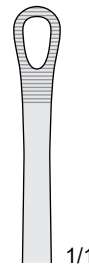
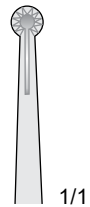
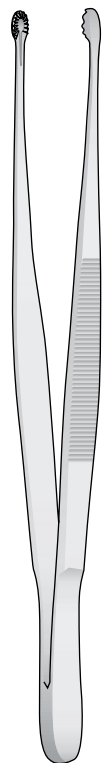
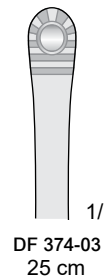
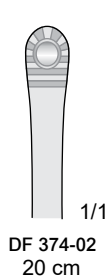
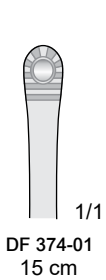
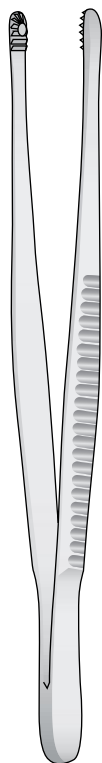

RUSSIAN
 DF 374-01 / DF 374-03

SELMAN
 DF 375-15 15 cm

SINGLEY-TUTTLE
 DF 376-23 23 cm

MAYO-RUSSIAN
 DF 377-23 23 cm

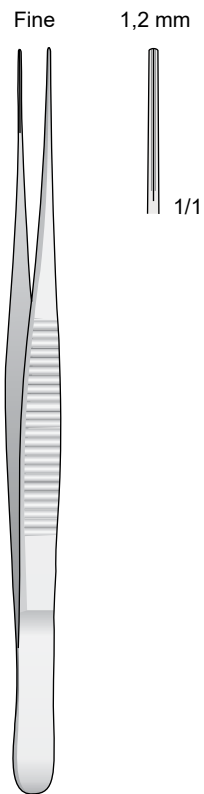

DE BAKEY

ATF 378-19 19.5 cm



DE BAKEY

ATF 379-01 / ATF 379-03

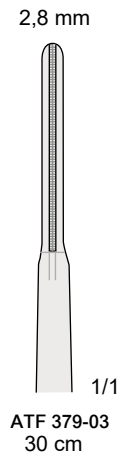
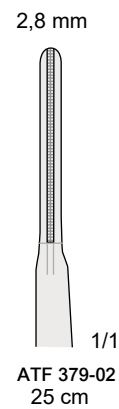
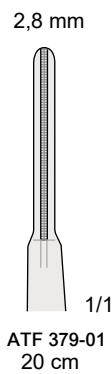

Pinzette atraumatiche
 Atraumatic Tissue forceps
 Atraumatische Pinzette
 Pincés Atraumatique
 Pinzas Atraumaticas

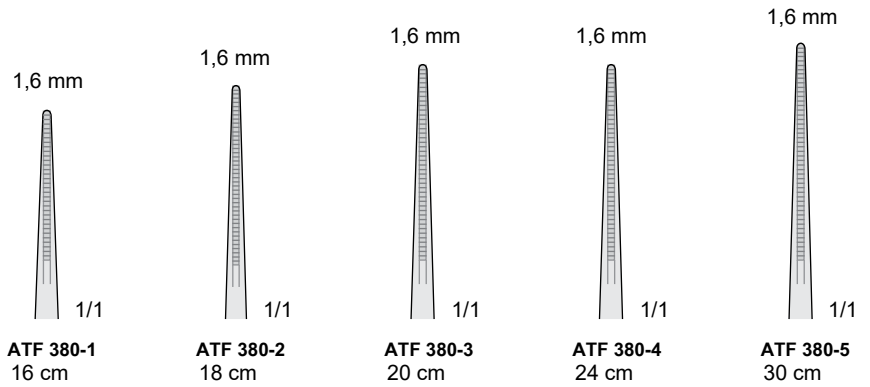

Pinzette atraumatiche
 Non-traumatic vascular tissue forceps
 Atraumatische pinzetten
 Pincés atraumatiques
 Pinzas atraumaticas

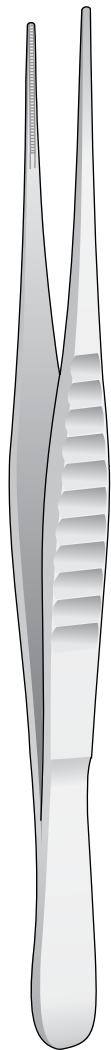

DE BAKEY

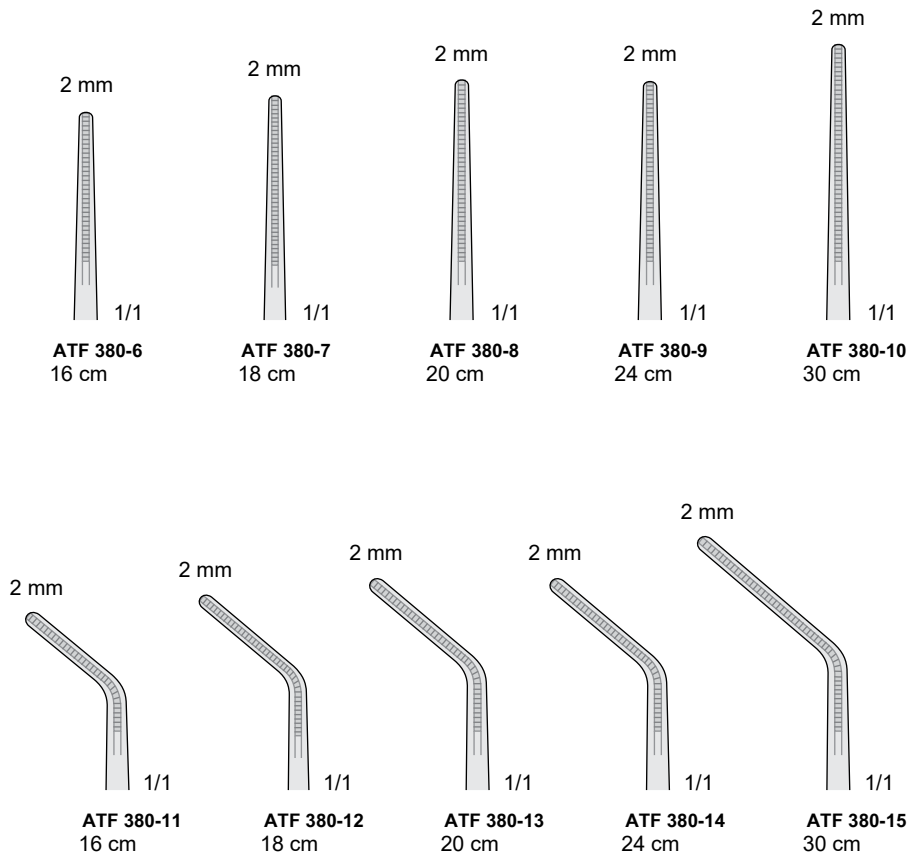

ATF 380-01 / ATF 380-15

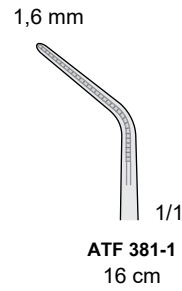

Pinzette atraumatiche
Atraumatische pinzetten
Atraumatic vascular tissue forceps
Pincas atraumaticas
Pinzas atraumaticas

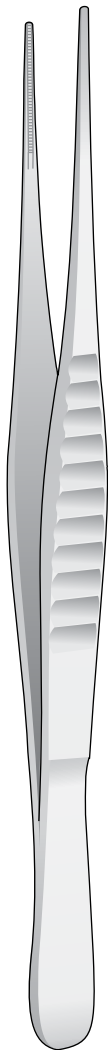

DE BAKEY

ATF 381-01 / ATF 381-09

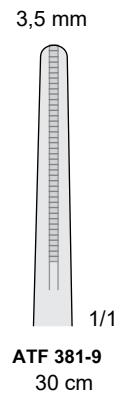
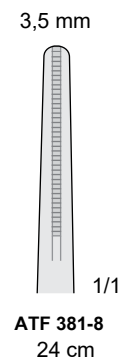
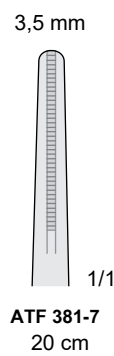
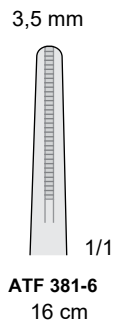
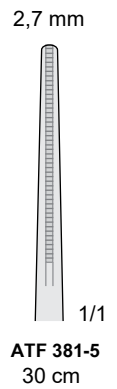
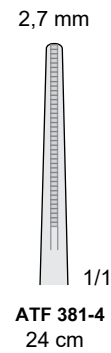
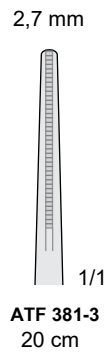
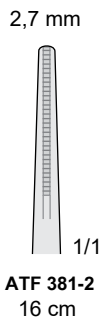

Micro pinzette
 Delicate forceps
 Micro Pinzetten
 Micro pincers
 Pinzas finos

Pinze da Fissazione-oftalmica - Fixier und fasspinzetten
 Fixation and Grasping forceps - Pinzas de fijación y de aprehensión

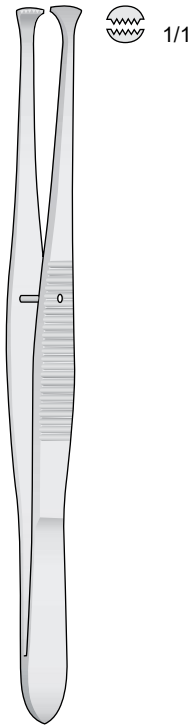

GRAEFE
DF 382-11 11 cm

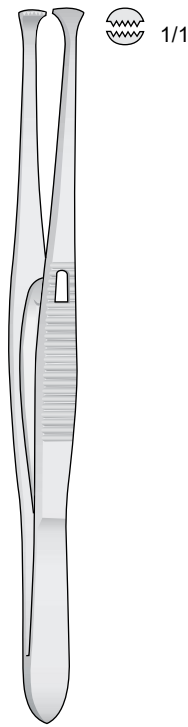

GRAEFE
DF 383-11 11 cm

Pinzetta-Columella
 con stop



COTTLE
DF 384-10 10 cm

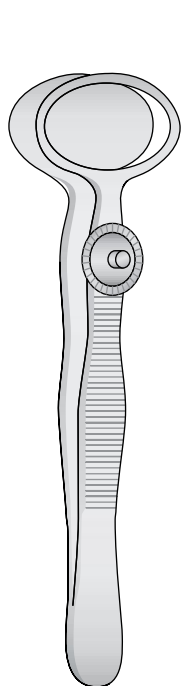
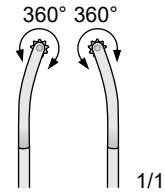

DESMARRES
DF 385-01 / DF 385-03
 9 cm

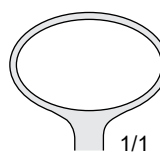

1/1
DF 385-01
 20 cm

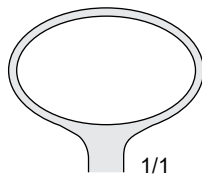

1/1
DF 385-02
 26 cm

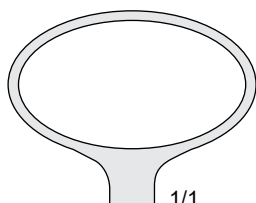

1/1
DF 385-03



DUVAL
DF 386-01 / DF 386-02

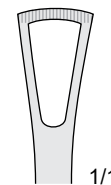

1/1
DF 386-01
 14 cm

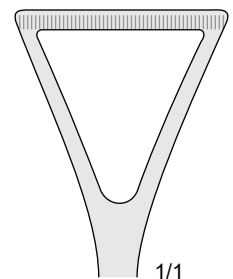

1/1
DF 386-02
 20 cm

Pinze intestinali
 Intestinal forceps
 Darpinzetten
 Pincers pour préhension de l'intestin
 Pinzas intestinales

Con punta al carburo di tungsteno - Tungsten-carbide forceps
Mit hartmetalleinsätzen - Avec plaquettes en carbure de tungstène - Pinzas con tungsteno

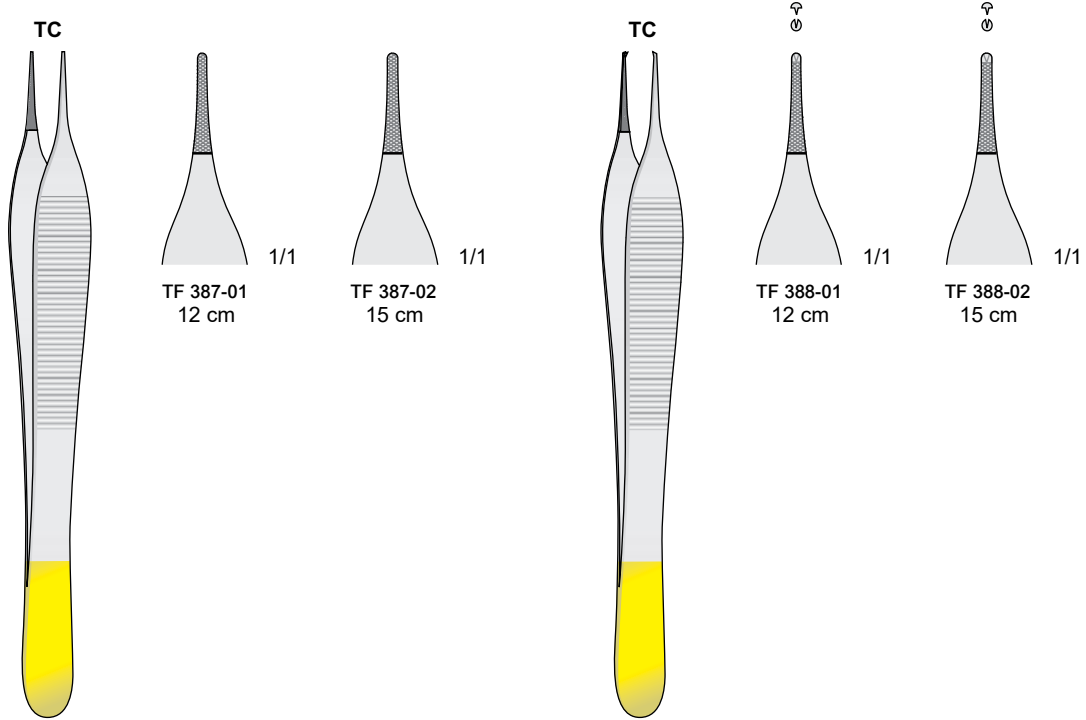

ADSON

TF 387-01 / TF 387-02

ADSON

TF 388-01 / TF 388-02

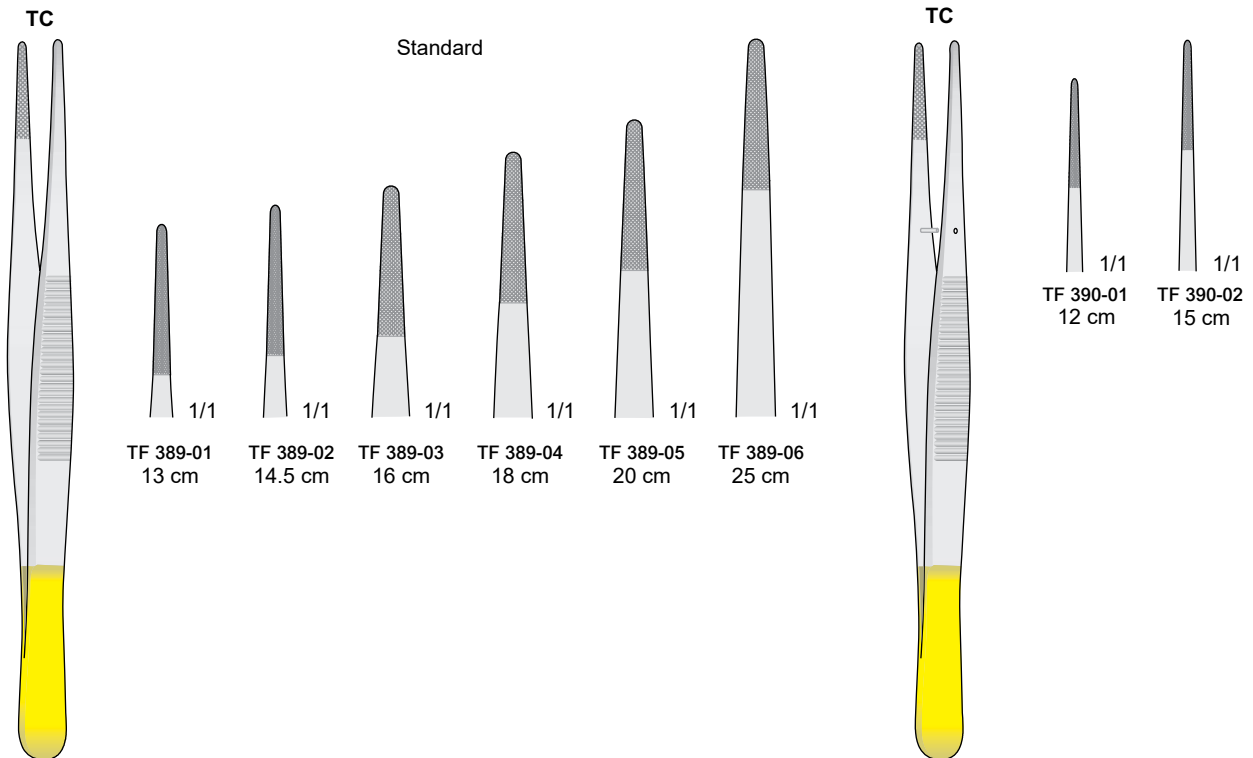

SEMKEN

TF 389-01 / TF 389-06

TF 390-01 / TF 390-02

Pinzette chirurgiche
Tissue forcep
Chirurgische pinzette
Pincas chirurgicale
Pinzas chirùrgicas

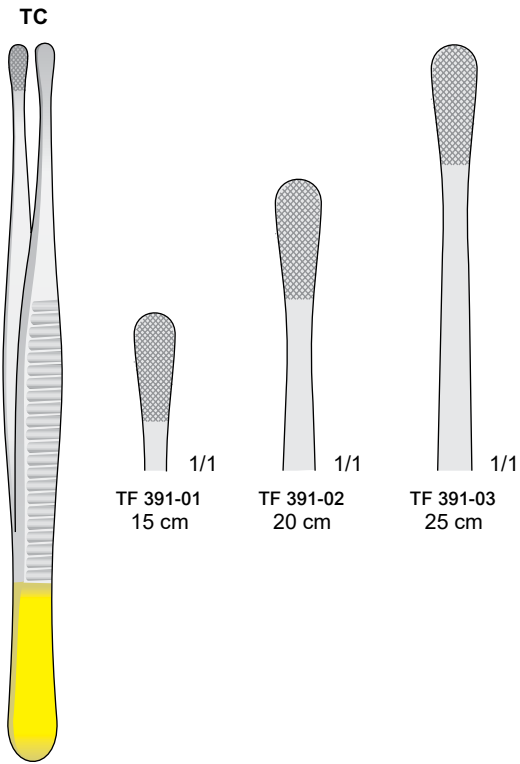

WANGENSTEEN
TF 391-01 / TF 391-03

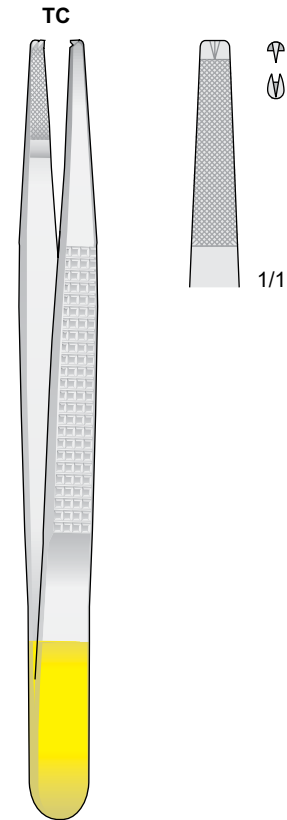

BONNEY
TF 392-18 18 cm

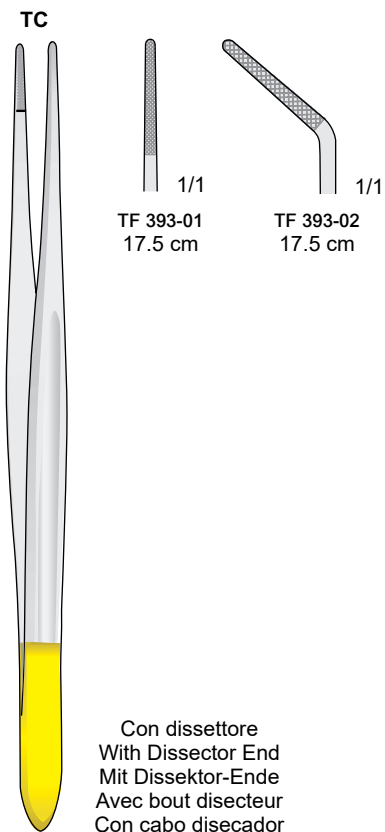

CUSHING
TF 393-01 / TF 393-02

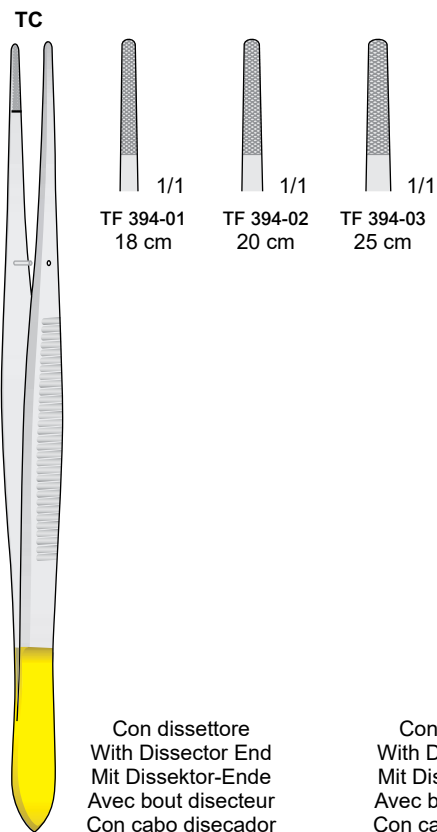

POTTS-SMITH
TF 394-01 / TF 394-03

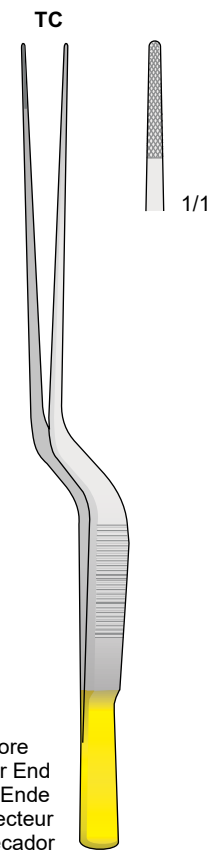

TAYLOR
TF 395-18 18.5 cm

Con punta al carburo di tungsteno
Tungsten-carbide forceps
Mit hartmetalleinsätzen
Avec plaquettes en carbure de tungstène
Pinzas con tungsteno

TC

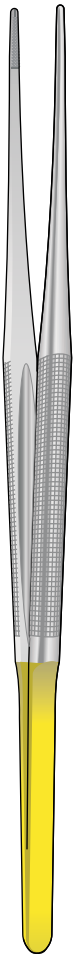

DE BAKAY

TF 396-18 18 cm

TC



TF 397-01 / TF 397-06

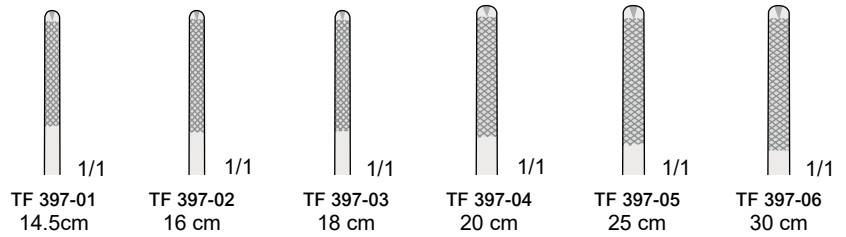

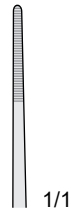
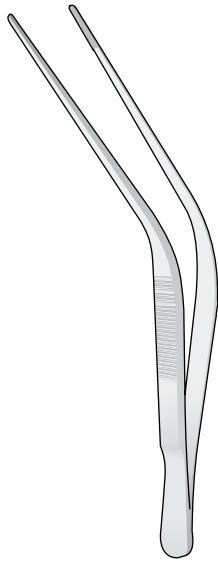

TROELTSCH

EF 398-11 11 cm

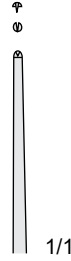
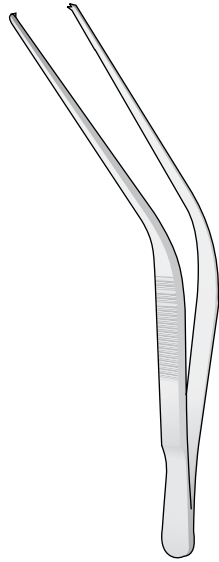

TROELTSCH

EF 399-11 11 cm

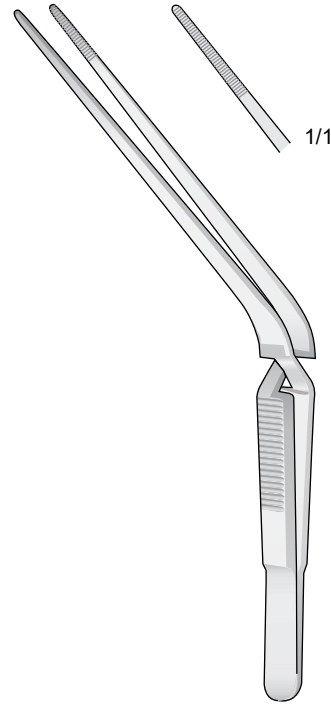

1/1

TROELTSCH

EF 400-13 13 cm

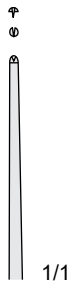

LUCAE

EF 401-14 14 cm

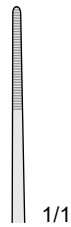
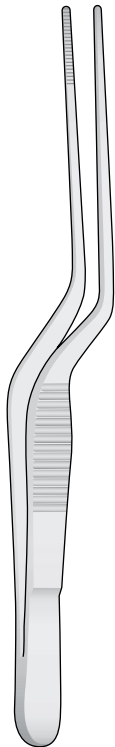

LUCAE

EF 402-14 14 cm

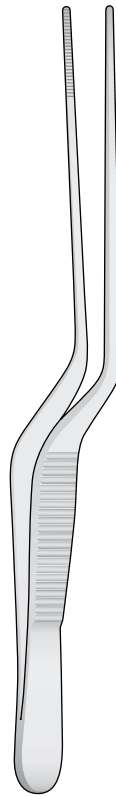

JANSEN

EF 403-16 16 cm

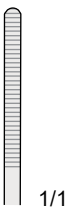

GRÜENWALD

EF 404-20 20 cm

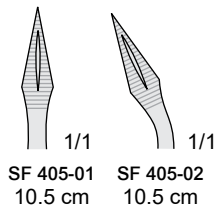

HUNTER
SF 405-01 / SF 405-02

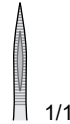

FEICHENFELD
SF 406-7 7.5 cm

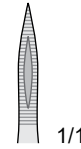

FEICHENFELD
SF 407-9 9 cm

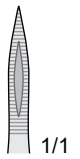
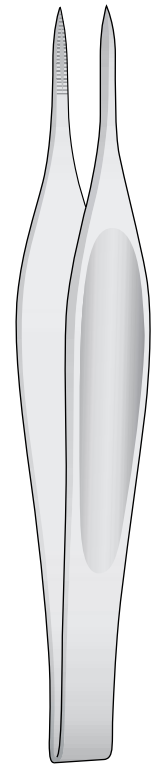

FEICHENFELD
SF 408-11 11.5 cm

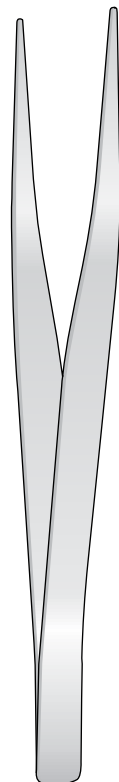

SF 409-15 15 cm

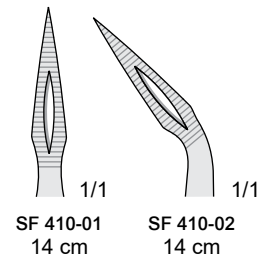
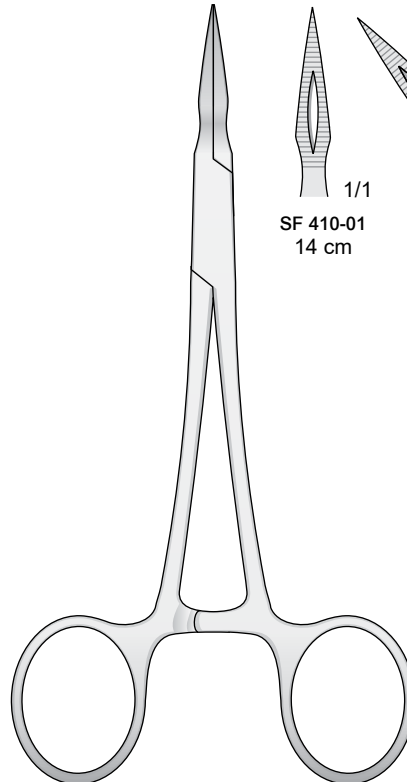

STIEGLITZ
SF 410-01 / SF 410-02

Pinzette Depilatori
 Cilia forcep
 Cilienpinzette
 Pincés à épiler les cil
 Pinzas depilatorie

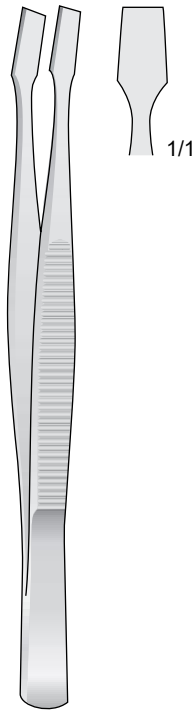

KÜHNE
CF 411-10 10.5 cm

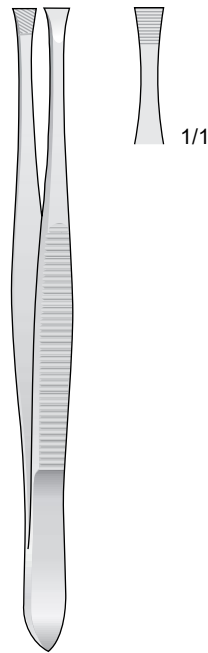

LITTAUER
CF 412-8 8.5 cm

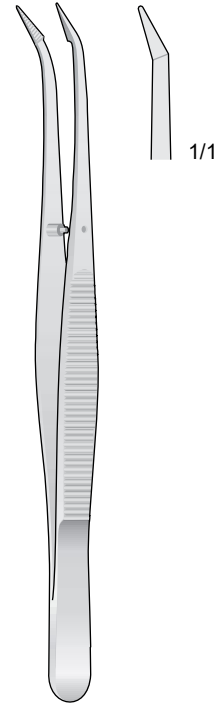

BARRAQUER
CF 413-10 10.5 cm

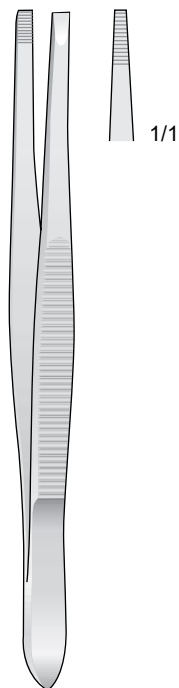

CF 414-9 9 cm

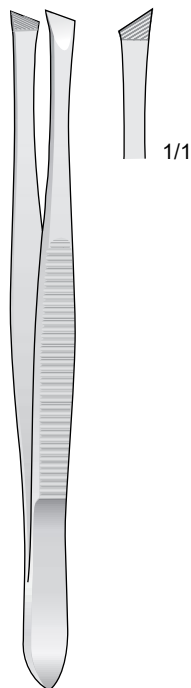

CF 415-9 9 cm

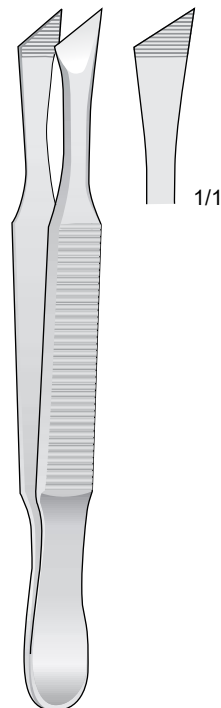

BERGH
CF 416-10 10.5 cm

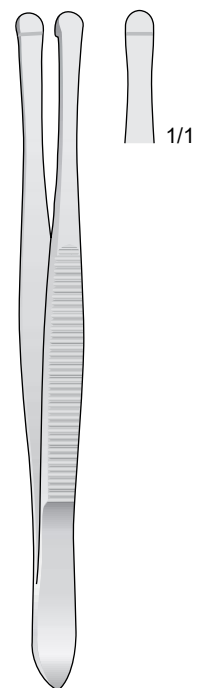

BEER
CF 417-9 9 cm



we take a closer look

+ Hemostatic Forceps Towel Clamps



+
Arterienklemmen | Tuchklemmen
Pincés hémostatiques | Pincés à champs
Pinzas hemostáticas | Pinzas de campo
Pinzette emostatiche | Fissateli

Pinze emostatic
 Hemostatic forcep
 Arterienklemme
 Pincés hémostatique
 Pinzas hemostáticas

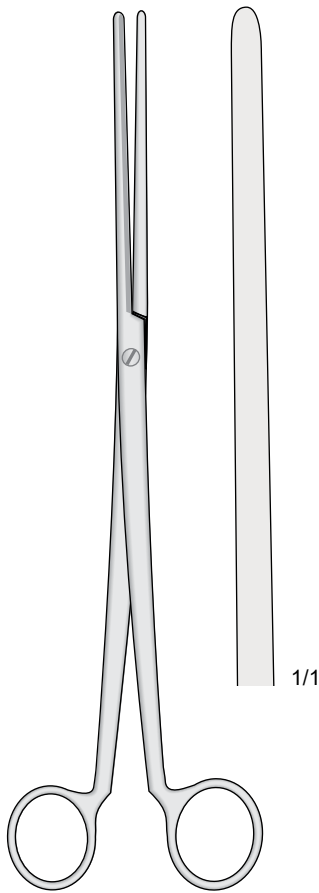

COLLIN
HF 420-26 26 cm

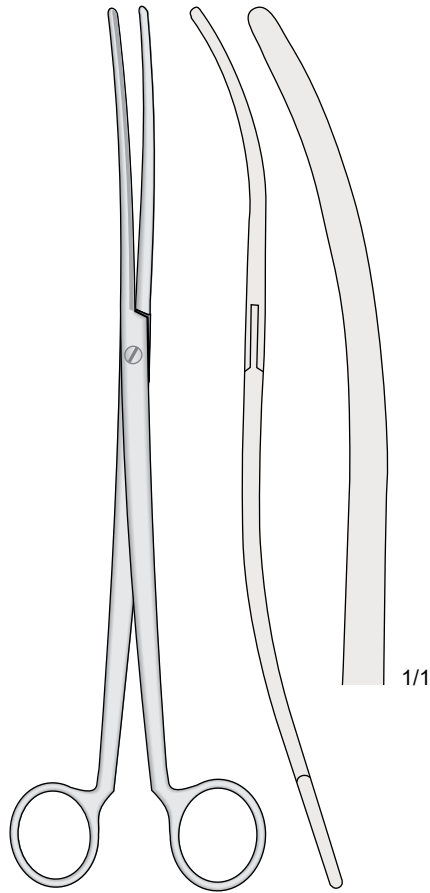

COLLIN
HF 421-26 26 cm

Pinze Sinus
 Sinus forceps
 Sinus klemmen
 Pincés à Sinus
 Pinzas para seno

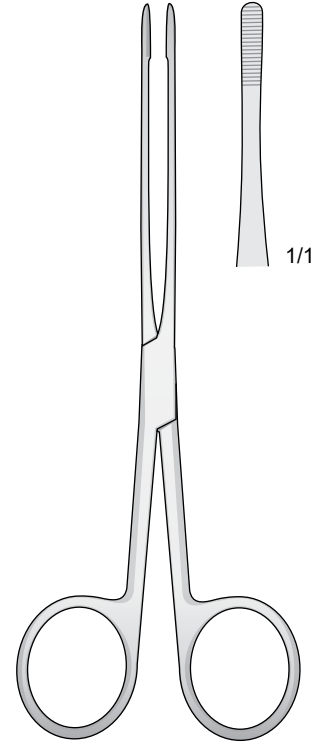

LISTER
HF 422-15 15 cm

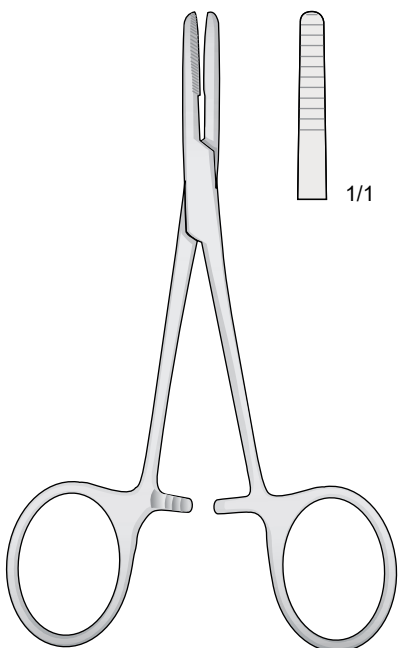

TERRIER
HF 423-13 13 cm

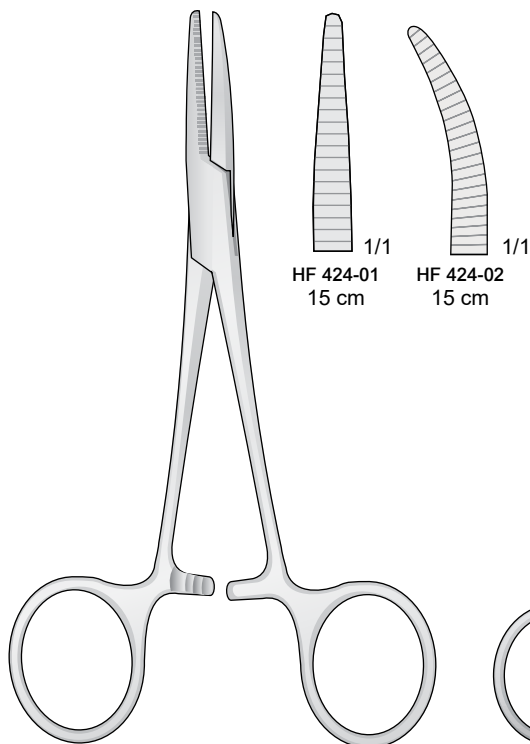

JONES
HF 424-01 / HF 424-02

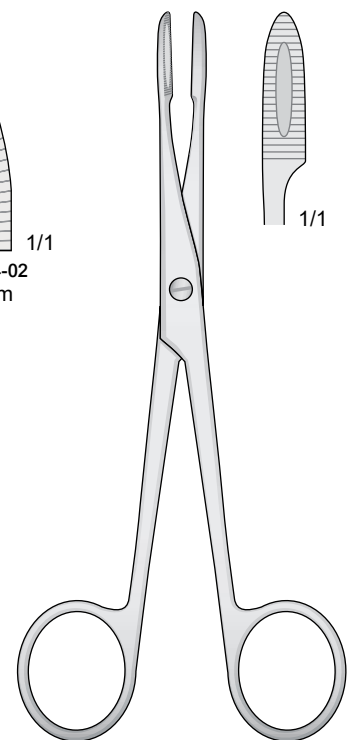

GROSS
HF 425-13 13 cm
HF 425-16 16 cm

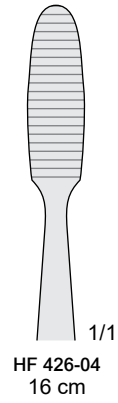
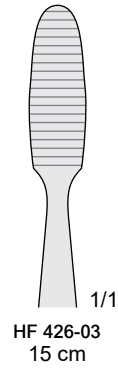
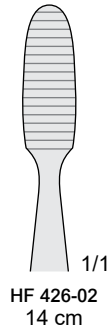
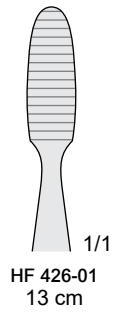
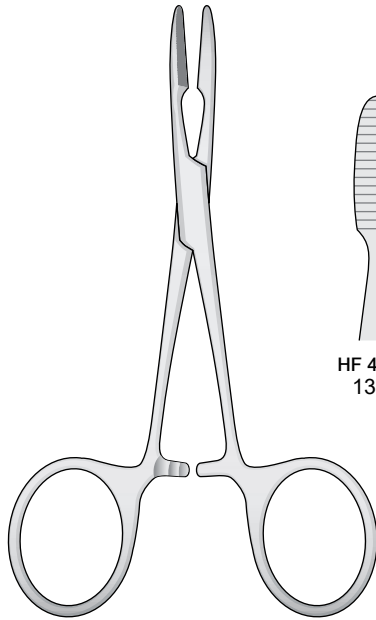

PEAN-MURPHY

HF 426-01 / HF 426-04

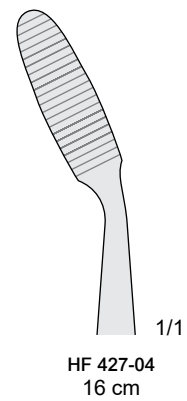
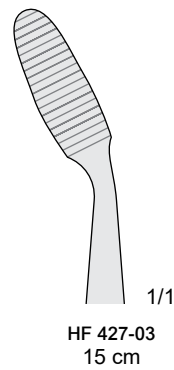
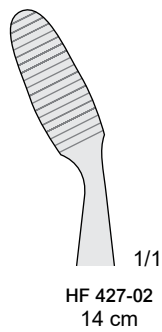
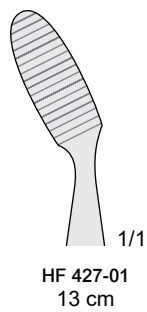
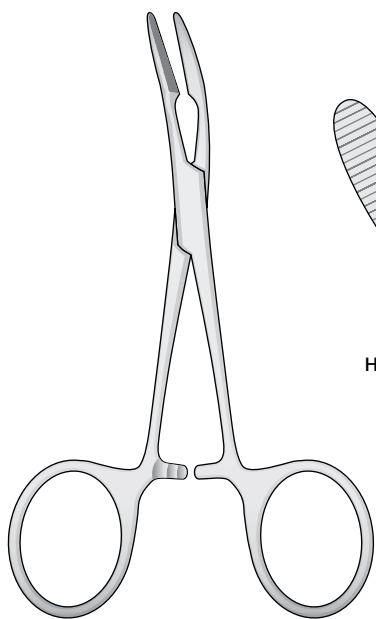

PEAN-MURPHY

HF 427-01 / HF 427-04

Pinze per tamponi
 Sponge and dressing forceps
 Schwamm und tamponzange
 Pincès à tampon
 Pinzas para tampones

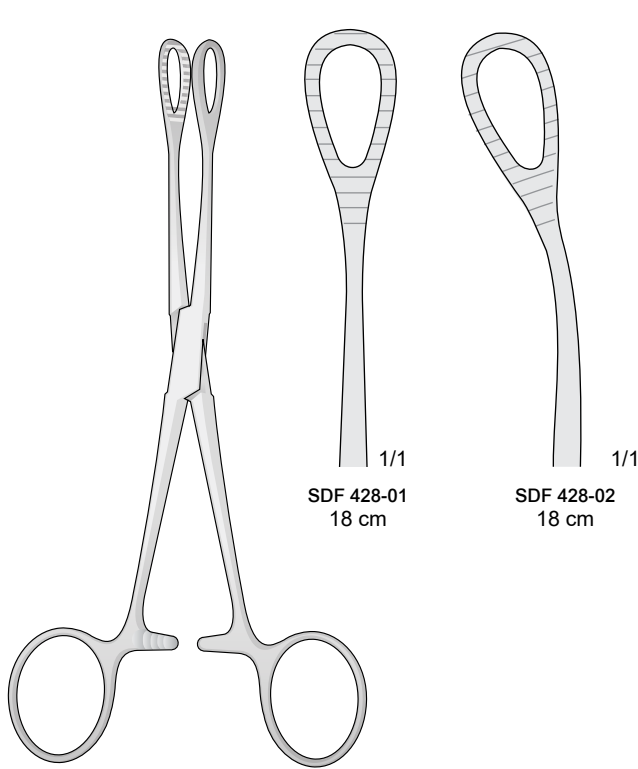

FOERSTER-BALLENGER
SDF 428-01 / SDF 428-02

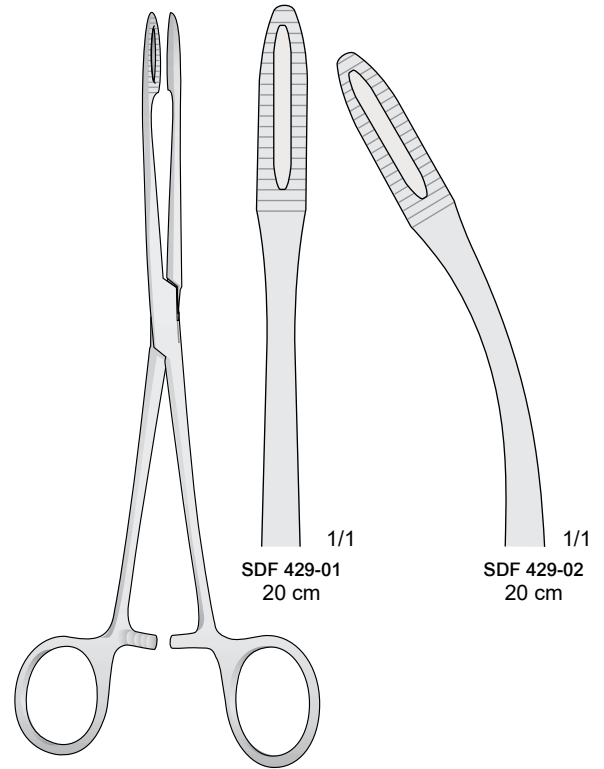

GROSS
SDF 429-01 / SDF 429-02

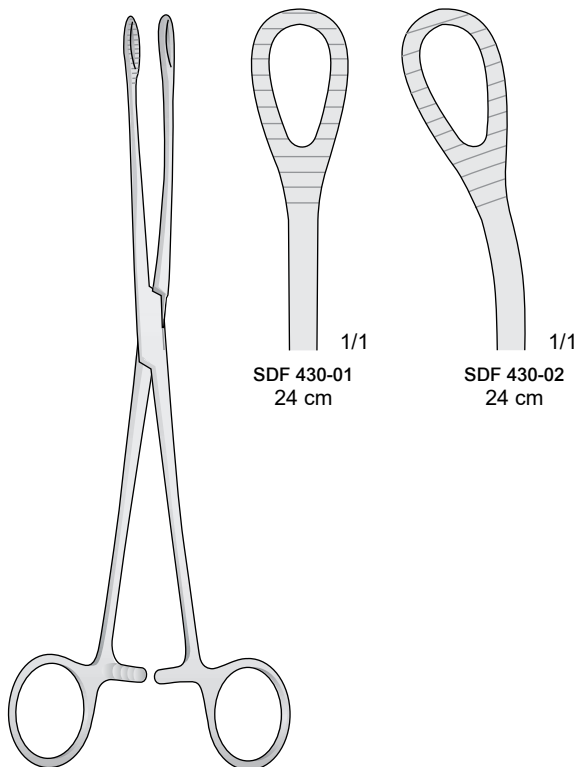

FOERSTER-BALLENGER
SDF 430-01 / SDF 430-02

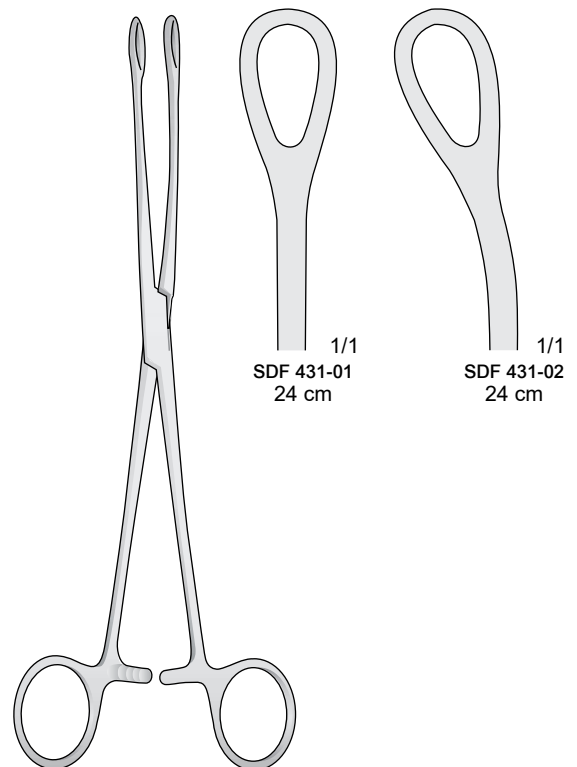

FOERSTER-BALLENGER
SDF 431-01 / SDF 431-02

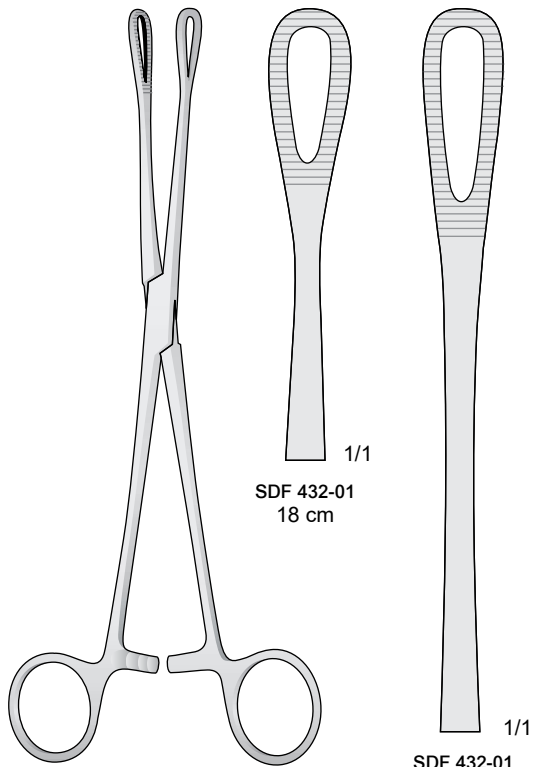

SDF 432-01
18 cm

SDF 432-01
24.5 cm

RAMPLEY

SDF 432-01 / SDF 432-02

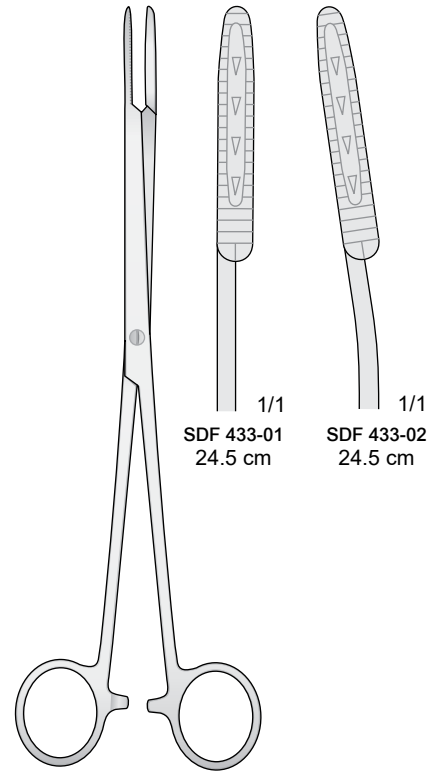

SDF 433-01
24.5 cm

SDF 433-02
24.5 cm

MAIER

SDF 433-01 / SDF 433-02

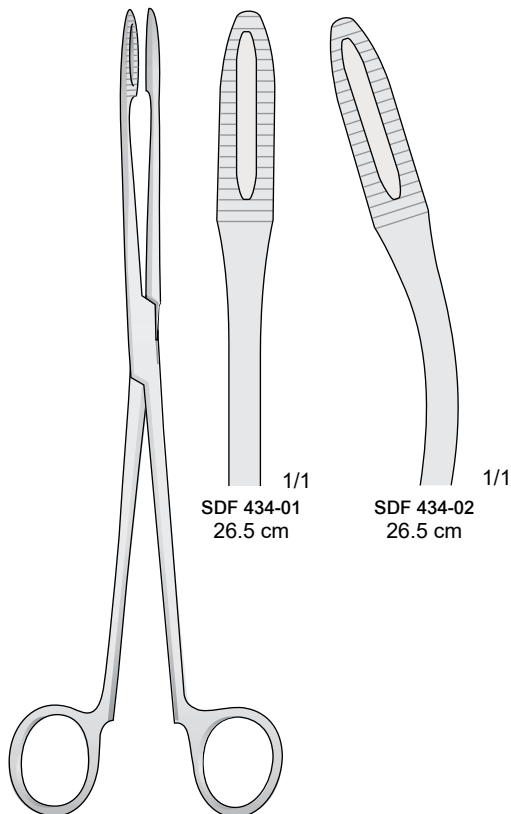

SDF 434-01
26.5 cm

SDF 434-02
26.5 cm

MAIER

SDF 434-01 / SDF 434-02

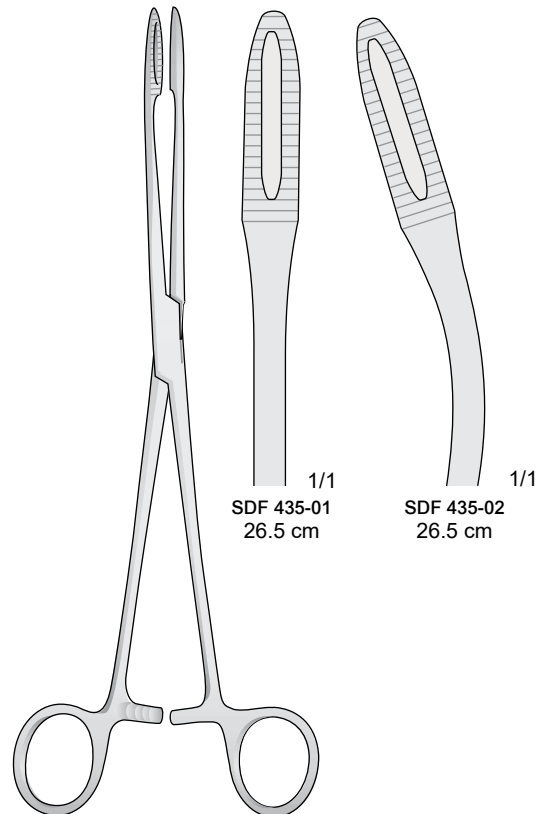

SDF 435-01
26.5 cm

SDF 435-02
26.5 cm

MAIER

SDF 435-01 / SDF 435-02

Pinze tirlingua
 Tongueforceps
 Zungenzangen
 Pincés tire-langue
 Pinzas tira-lengua

Gommini di ricambio 2 pezzi - Pair, Rubber jaws, only
 Paar, Gummipolster, Allein - Paire, mors en caotchouc, seuls
 Par, Bocas de goma, sueltas

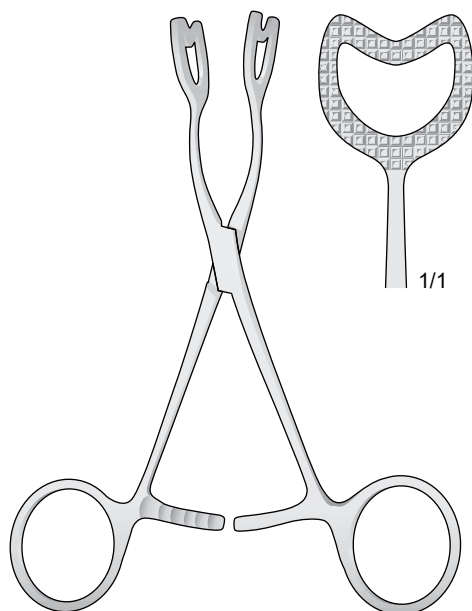

TF 436-14 14 cm

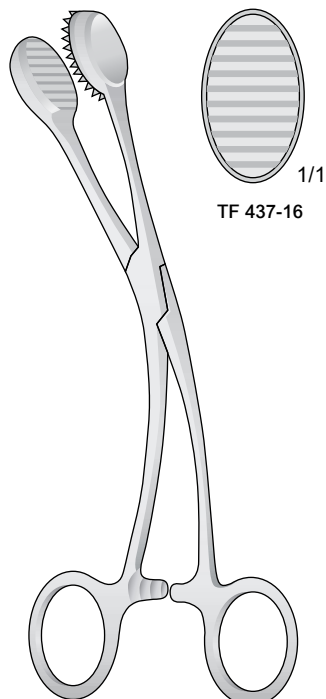

TF 437-16 16 cm

Gommini di ricambio 2 pezzi - Pair, Rubber jaws, only
 Paar, Gummipolster, Allein - Paire, mors en caotchouc, seuls
 Par, Bocas de goma, sueltas

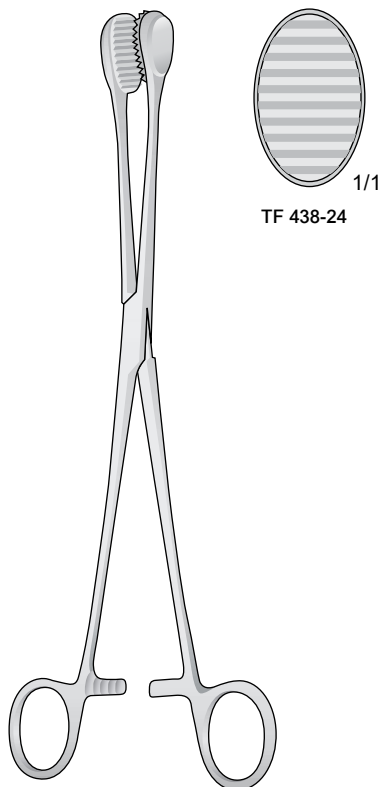

CHILD
TF 438-24 24 cm

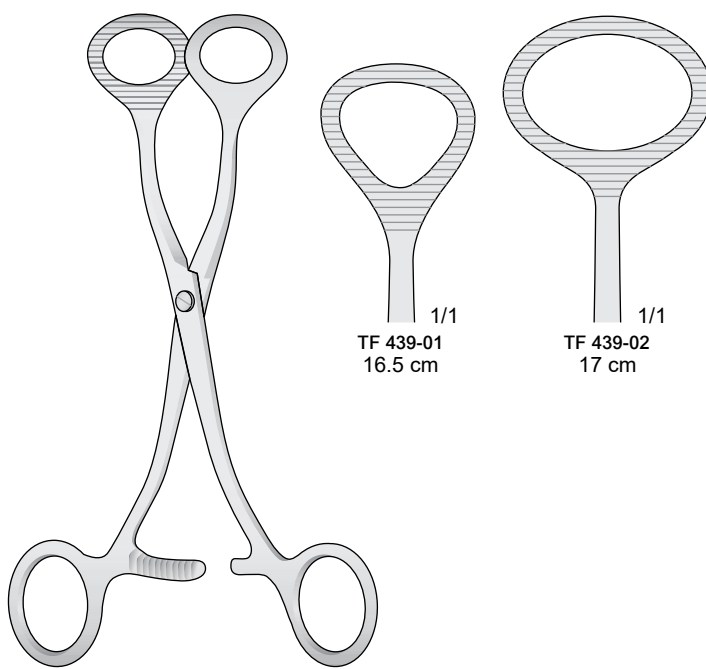

COLLIN
TF 439-01 / TF 439-02

Pinza per batuffoli e tamponi
Cotton swab-sponge holding forceps
Tupfer-Schwammzangen - Pincas à tampons et éponges
Pinzas para tampones porta esponjas

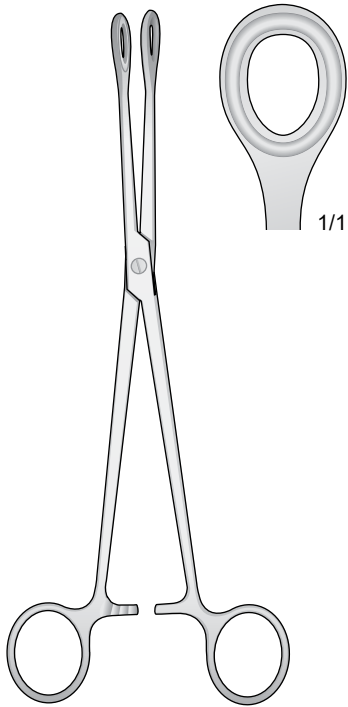

AF 440-23 23 cm

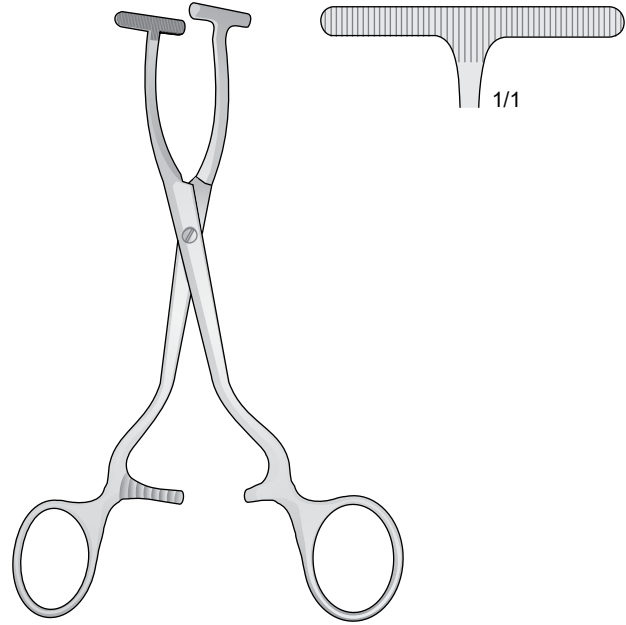

AF 441-15 15 cm

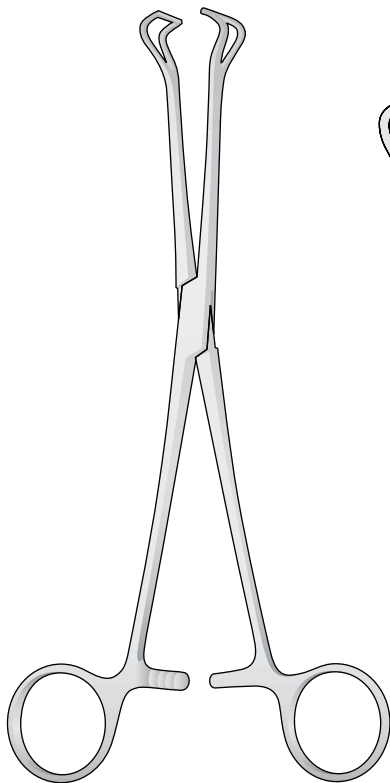

BABCOCK
AF 442-01 / AF 442-03

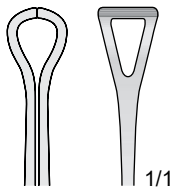

AF 442-01
15.5 cm

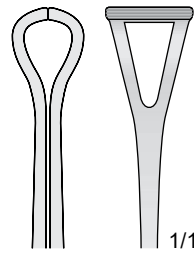

AF 442-02
18 cm

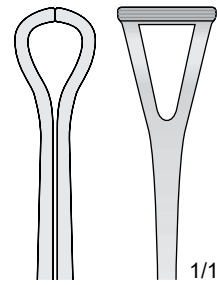

AF 442-03
24 cm

Pinze per afferrare i tessuti
 Gum and tissue forceps
 Gewebe und organ Fasszangen
 Pincés pour saisir les tissue
 Pinzas para coger las encias

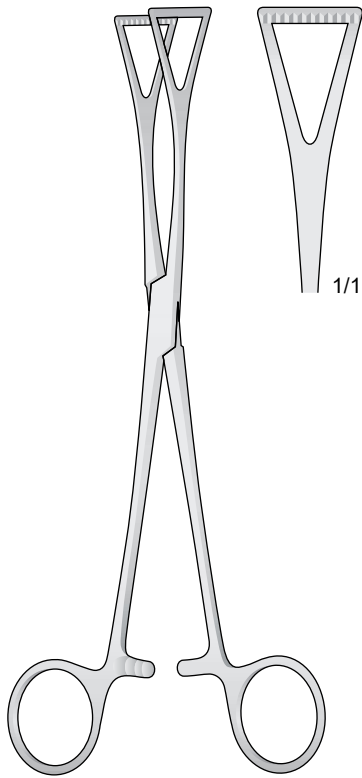

DUVAL

GTF 443-18 18.5 cm

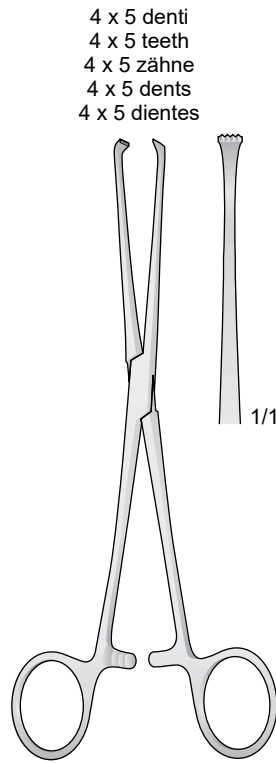

4 x 5 denti
 4 x 5 teeth
 4 x 5 zähne
 4 x 5 dents
 4 x 5 dientes

BABY-ALLIS

GTF 444-13 13 cm

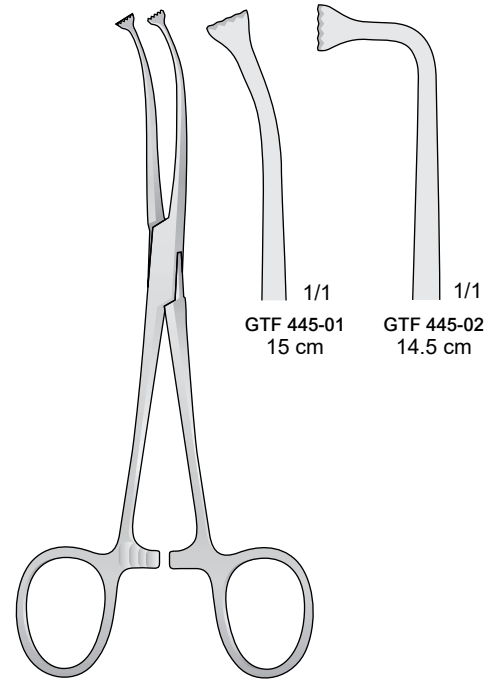

ALLIS

GTF 445-01 / GTF 445-02

GTF 445-01
15 cm

GTF 445-02
14.5 cm

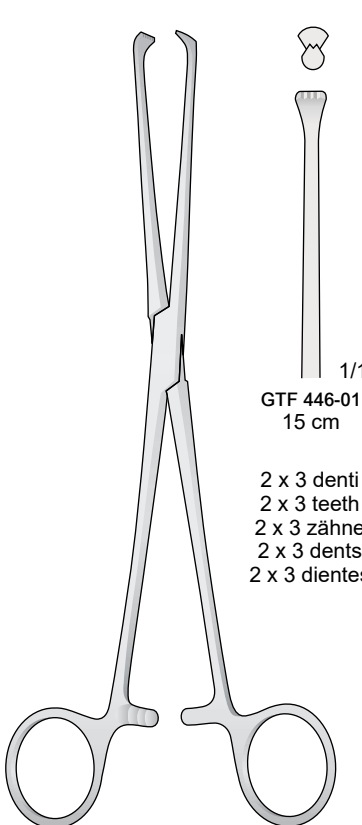

ALLIS

GTF 446-01 / GTF 446-07

1/1	1/1	1/1	1/1	1/1	1/1	1/1
GTF 446-01 15 cm	GTF 446-02 15 cm	GTF 446-03 15 cm	GTF 446-04 16 cm	GTF 446-05 20 cm	GTF 446-06 22 cm	GTF 446-07 25 cm
2 x 3 denti 2 x 3 teeth 2 x 3 zähne 2 x 3 dents 2 x 3 dientes	3 x 4 denti 3 x 4 teeth 3 x 4 zähne 3 x 4 dents 3 x 4 dientes	4 x 5 denti 4 x 5 teeth 4 x 5 zähne 4 x 5 dents 4 x 5 dientes	5 x 6 denti 5 x 6 teeth 5 x 6 zähne 5 x 6 dents 5 x 6 dientes	5 x 6 denti 5 x 6 teeth 5 x 6 zähne 5 x 6 dents 5 x 6 dientes	5 x 6 denti 5 x 6 teeth 5 x 6 zähne 5 x 6 dents 5 x 6 dientes	5 x 6 denti 5 x 6 teeth 5 x 6 zähne 5 x 6 dents 5 x 6 dientes

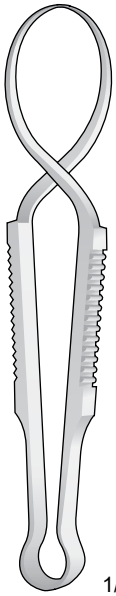

1/1

SCHAEDEL
TC 447-8 8.5 cm

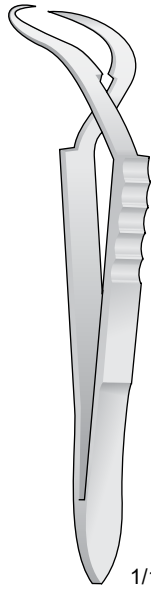

1/1

JONES
TC 448-9 9 cm

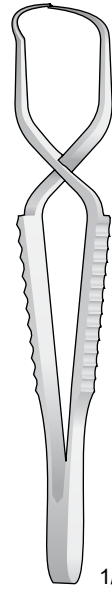

1/1

FAURE
TC 449-8 8.5 cm

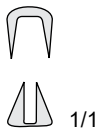
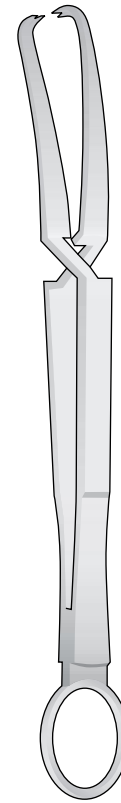

1/1

1/1

DOYEN
TC 450-18 18 cm

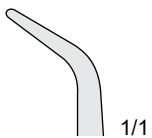

1/1

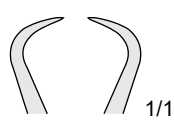
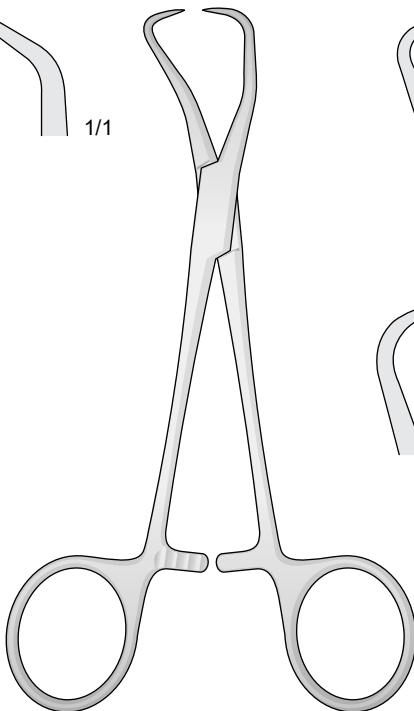

1/1

TC 451-01
9 cm

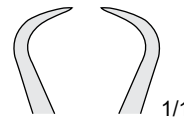

1/1

TC 451-02
10 cm

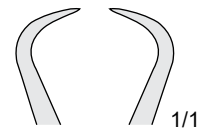

1/1

TC 451-03
11 cm

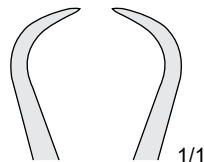

1/1

TC 451-04
13 cm

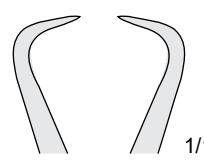

1/1

TC 451-05
13.5 cm

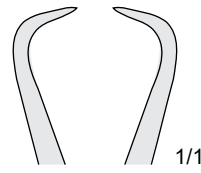

1/1

TC 451-06
14 cm

BACKHAUS
TC 451-01 / TC 451-02

Fissatel
Towel clamp
Tuchklemme
Pinces pour fixer les compresse
Pinzas de campo

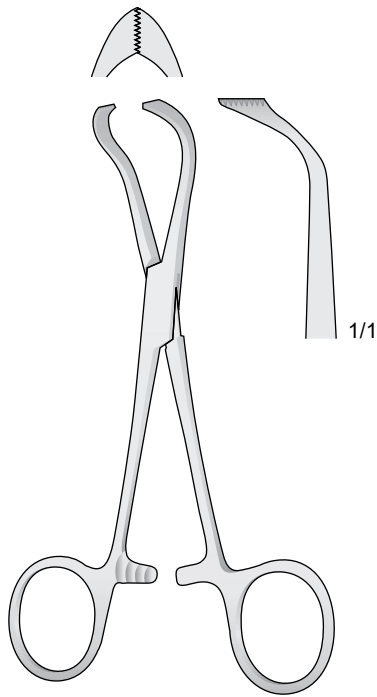

LORNA

TC 452-10 10 cm

Per teli di carta
For paper cloths
Für Papiertücher
Pour Champs en papier

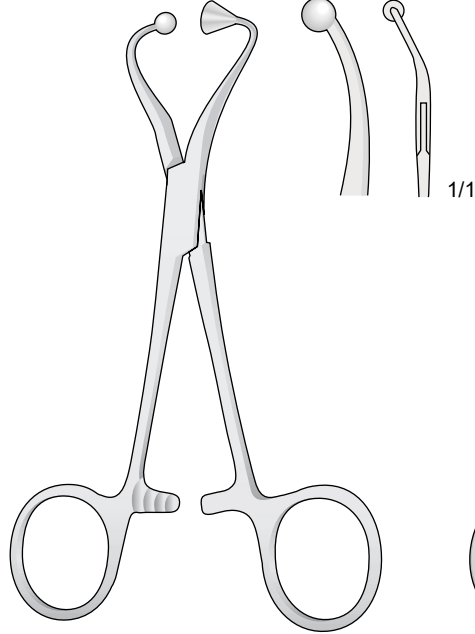

TC 453-11 11.5 cm

Per teli di carta
For paper cloths
Für Papiertücher
Pour Champs en papier

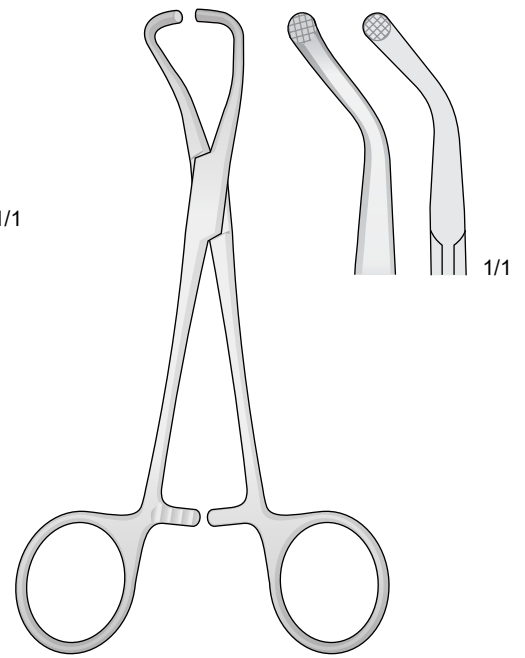

TC 454-13 13 cm

Per teli di carta
For paper cloths
Für Papiertücher
Pour Champs en papier

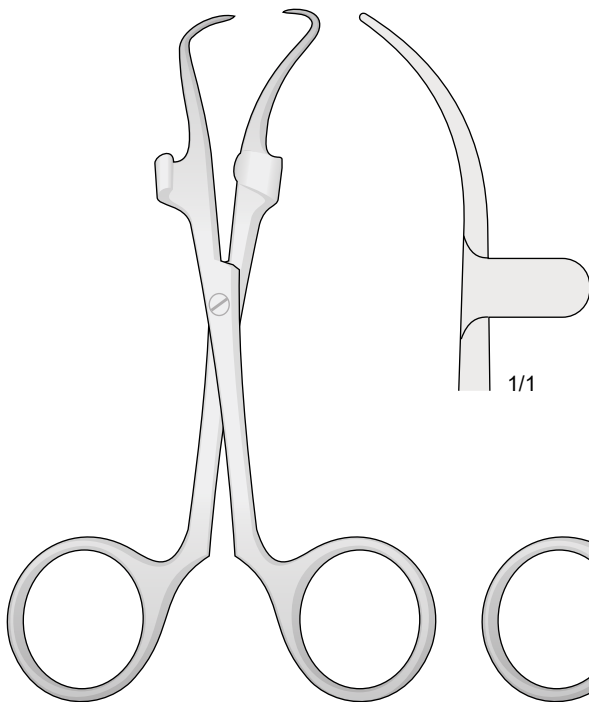

ROBIN

TC 455-14 14 cm

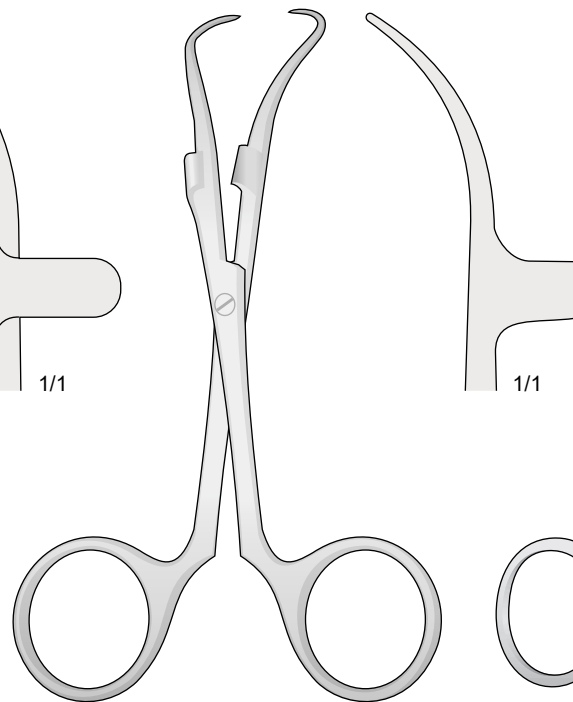

ROBIN

TC 456-14 14 cm

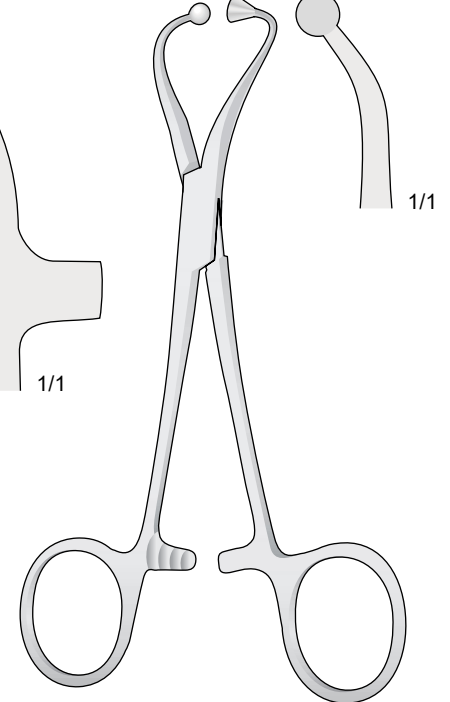

TC 457-14 14 cm

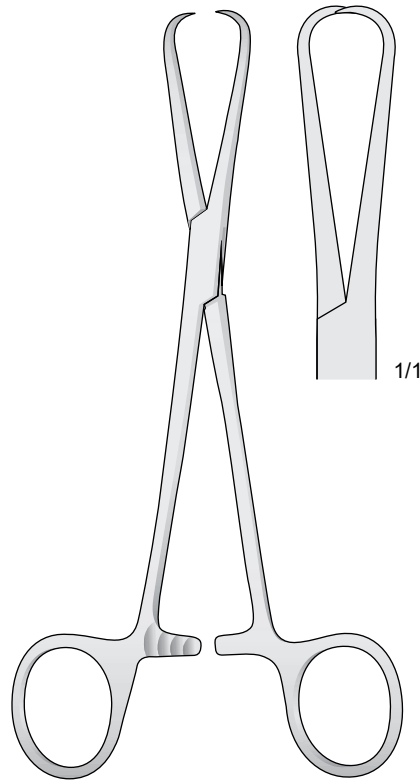

BERNHARD

TC 458-16 16.5 cm

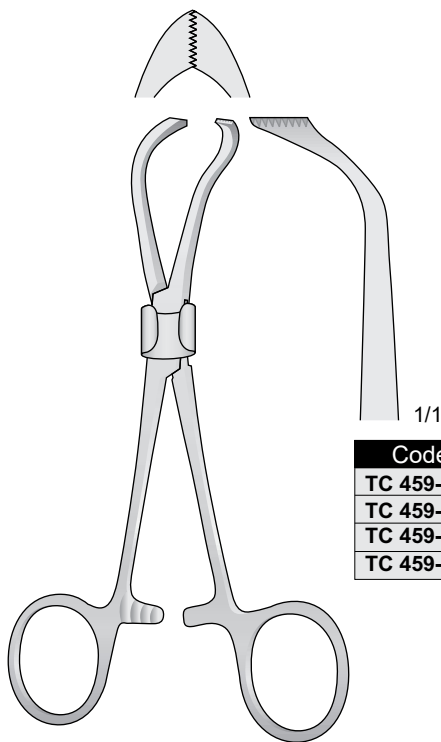

Code	Size
TC 459-01	Ø 9 mm
TC 459-02	Ø 12 mm
TC 459-03	Ø 14 mm
TC 459-04	Ø 17 mm

TC 459-01 / TC 459-04

10 cm

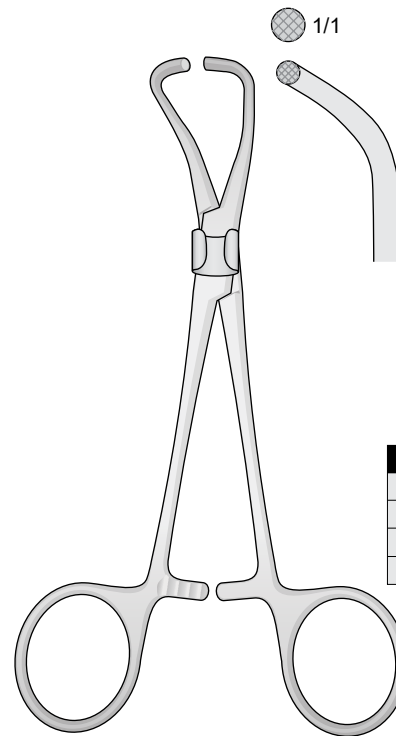

Code	Size
TC 460-01	Ø 9 mm
TC 460-02	Ø 12 mm
TC 460-03	Ø 14 mm
TC 460-04	Ø 17 mm

TC 460-01 / TC 460-04

13 cm

Pinze emostatiche delicate
 Fine Artery forceps
 Fine-Arterienklemmen
 Delicate Pincers hémostatiques
 Pinzas hemostáticas fino

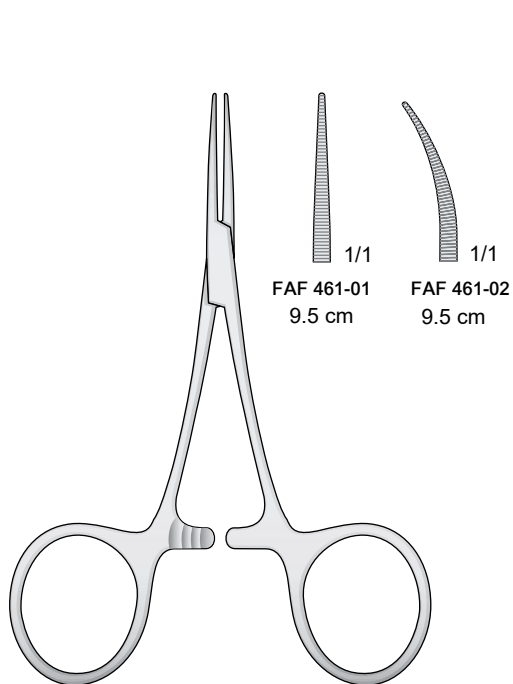

HARTMANN-BABY-MOSQUITO
FAF 461-01 / FAF 461-02

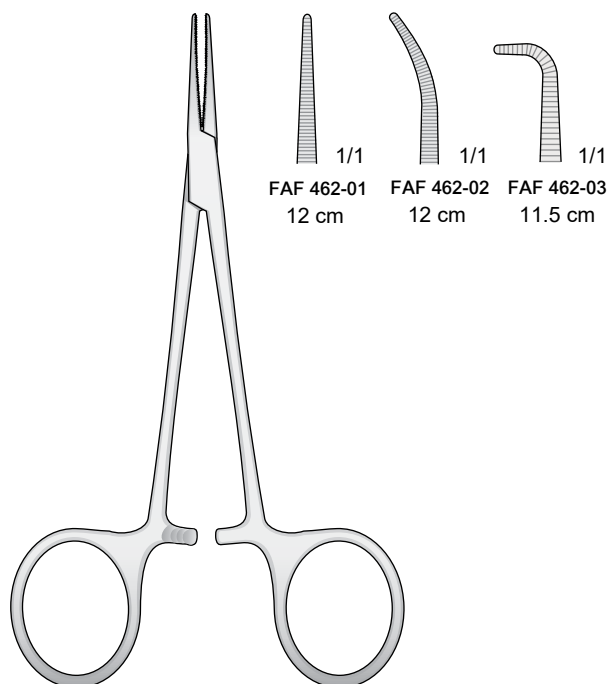

MICRO-HALSTED
FAF 462-01 / FAF 462-03

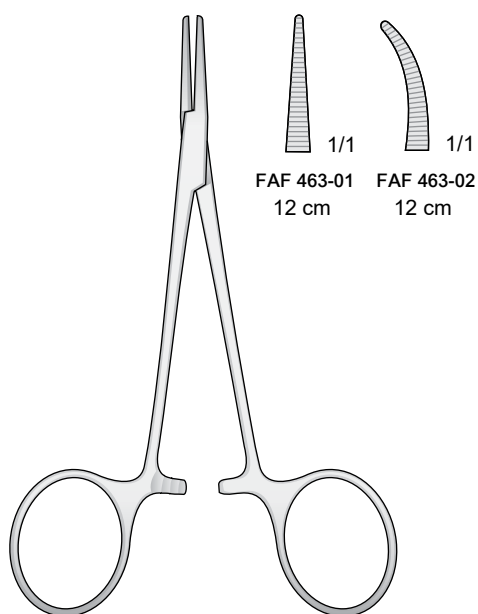

HALSTED-MOSQUITO
FAF 463-01 / FAF 463-02

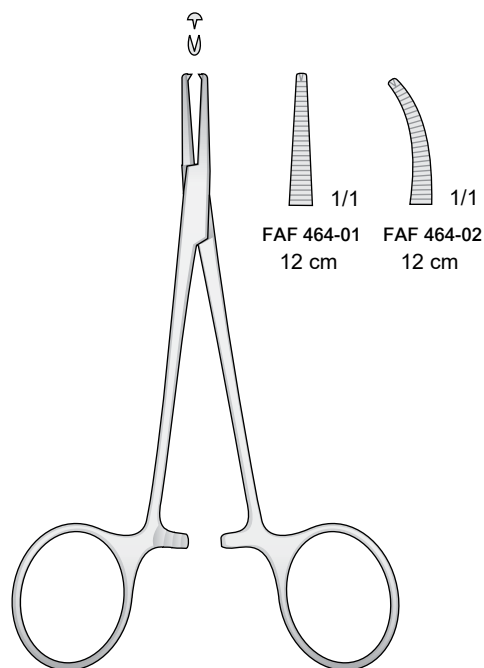

HALSTED-MOSQUITO
FAF 464-01 / FAF 464-02

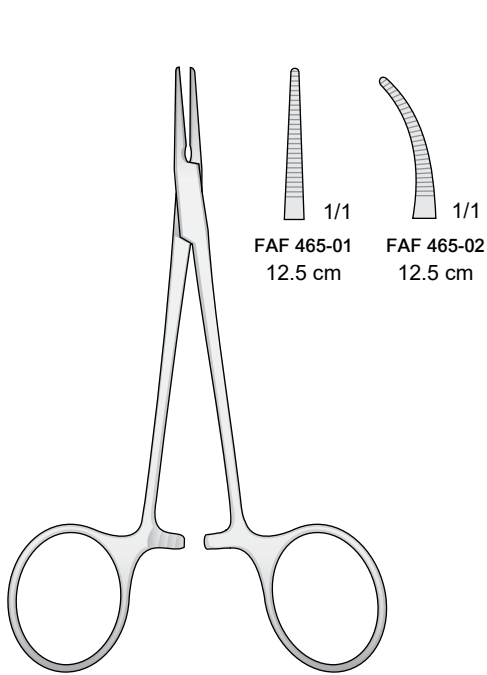

HALSTED
FAF 465-01 / FAF 465-02

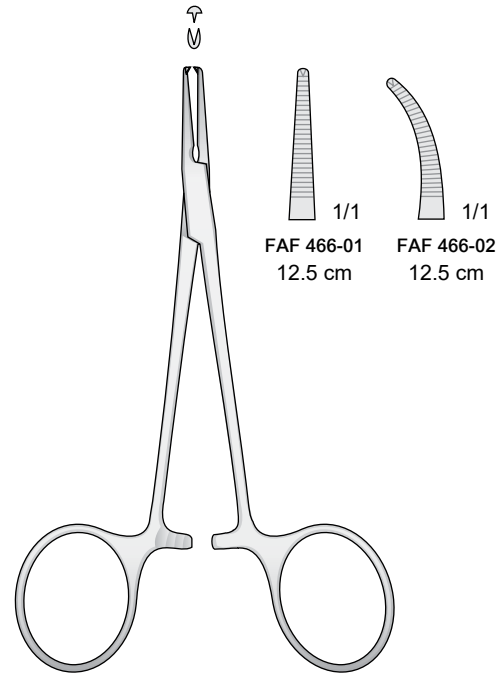

HALSTED
FAF 466-01 / FAF 466-02

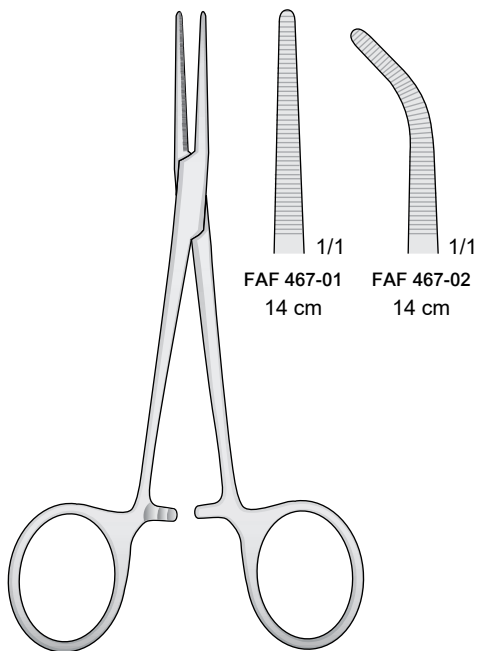

GIDEF
FAF 467-01 / FAF 467-02

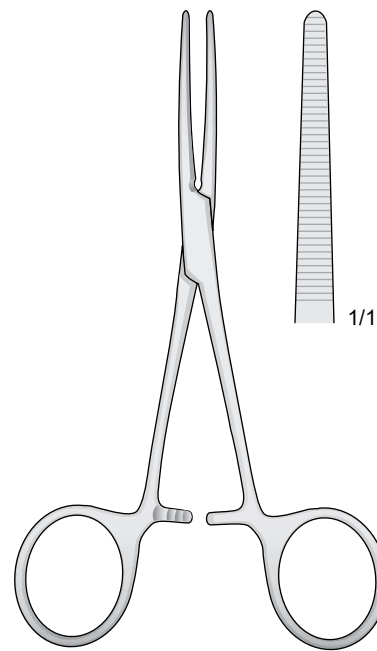

PEAN
FAF 468-14 14 cm

Pinze emostatic
 Hemostatic forcep
 Arterienklemme
 Pinces hémostatique
 Pinzas hemostáticas

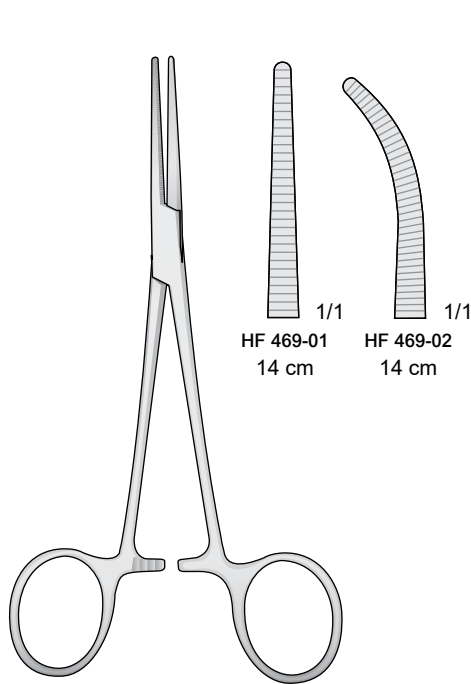

CRILE
HF 469-01 / HF 469-02

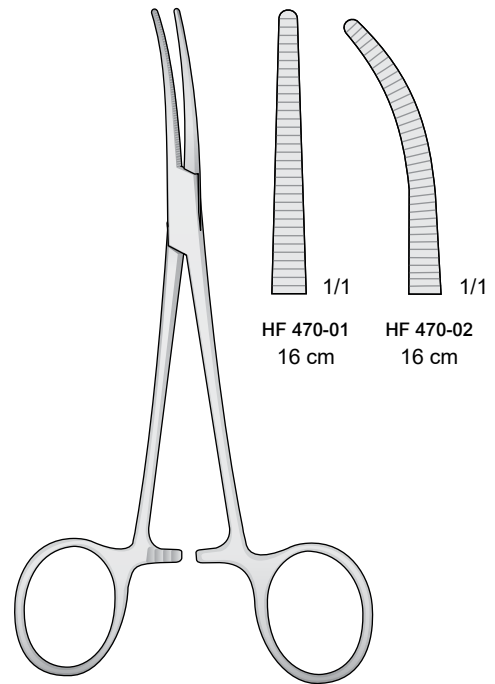

CRILE
HF 470-01 / HF 470-02

Curve sul lato
 Curved to side
 Seitwärts gebogen
 Courbes latérales
 Curvas laterales

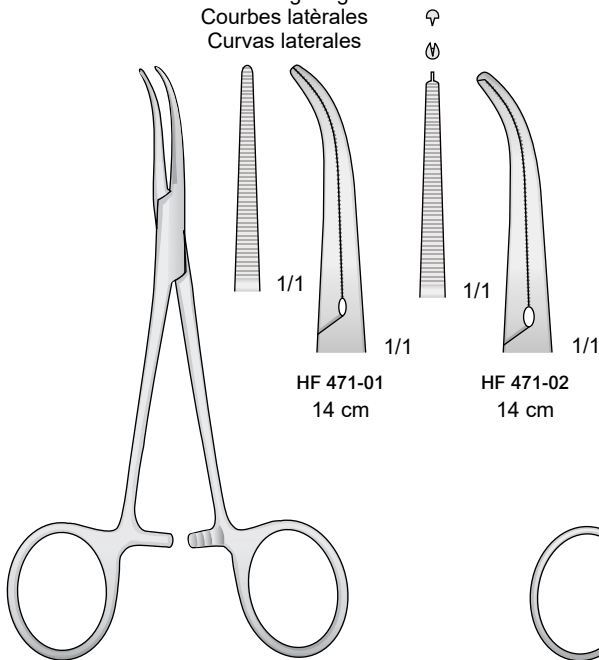

DANDY
HF 471-01 / HF 471-02

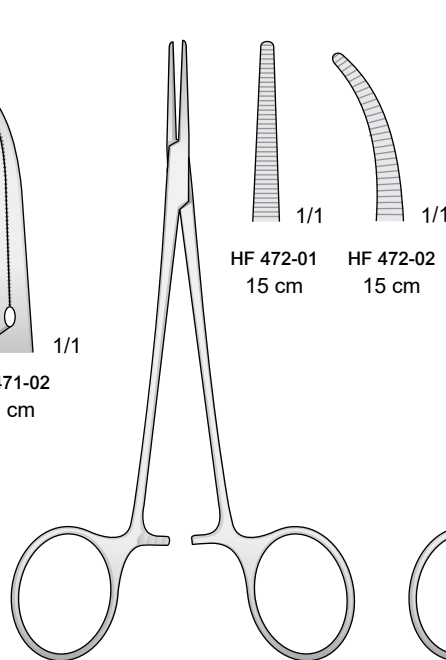

LERICHE
HF 472-01 / HF 472-02

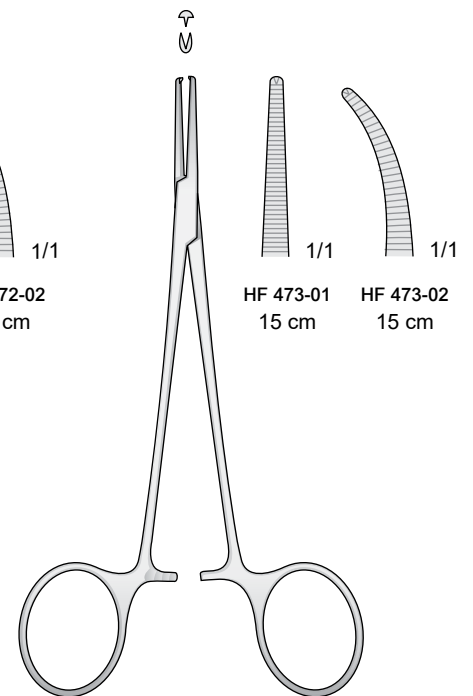

LERICHE
HF 473-01 / HF 473-02

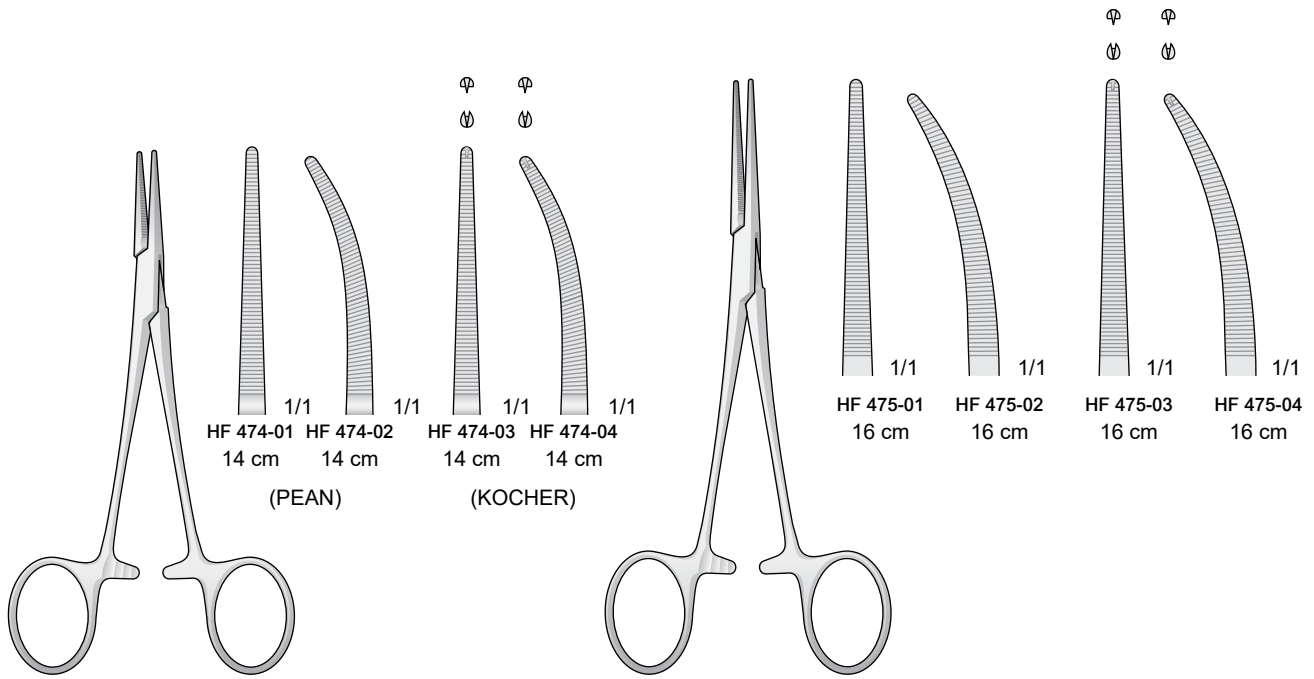

BABY-CRILE

HF 474-01 / HF 474-04

CRILE

HF 475-01 / HF 475-04

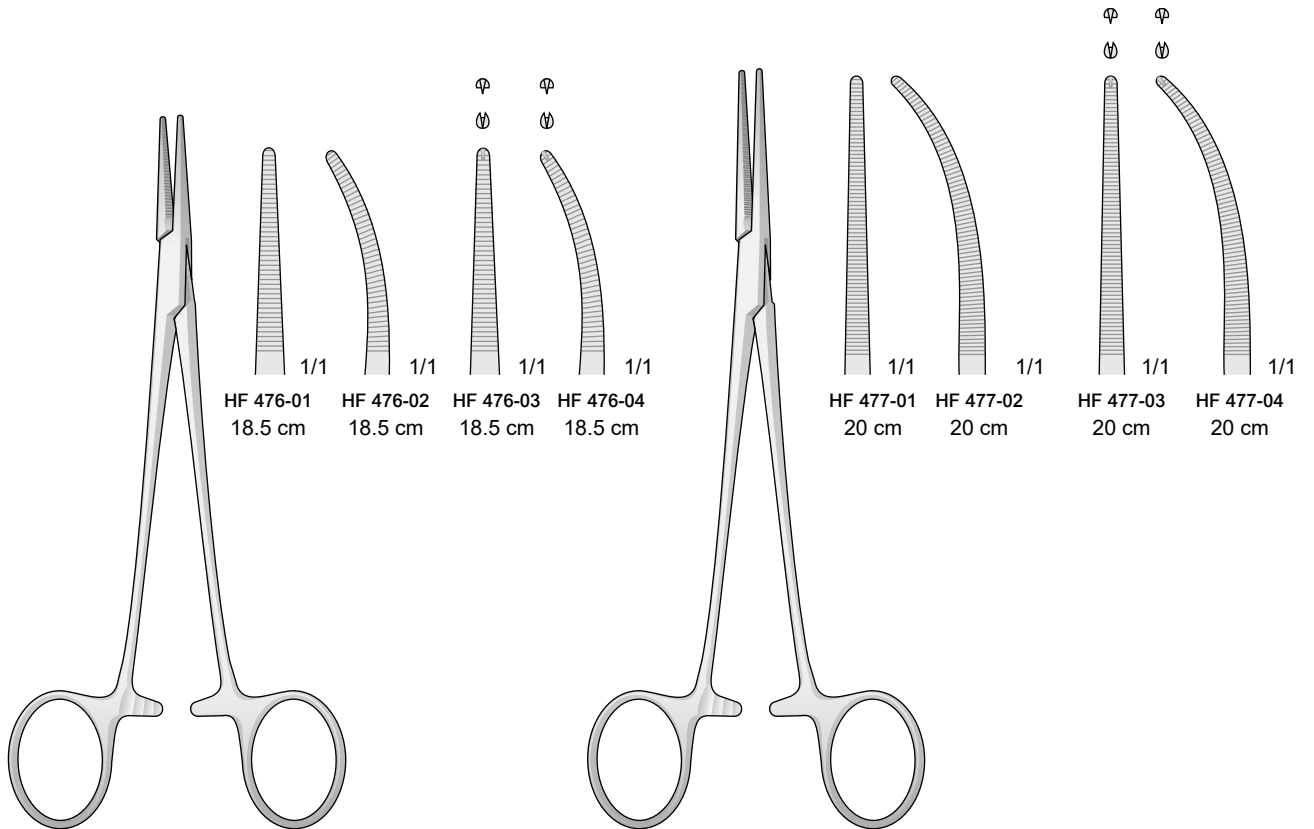

HALSTED

HF 476-01 / HF 476-04

HALSTED-MOSQUITO

HF 477-01 / HF 477-04

Pinze emostatic
 Hemostatic forcep
 Arterienklemme
 Pincés hémostatique
 Pinzas hemostáticas

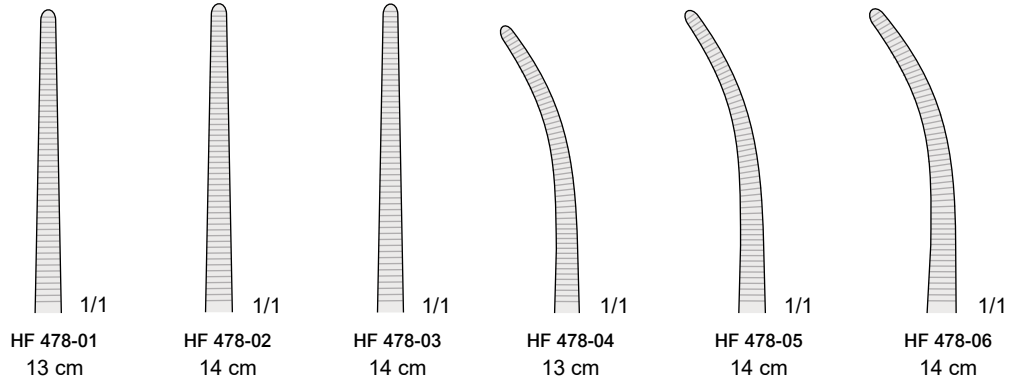
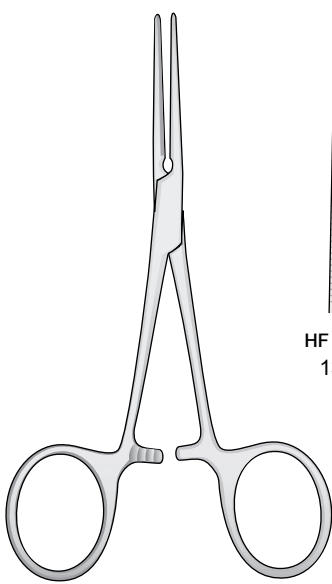

PEAN

HF 478-01 / HF 478-06

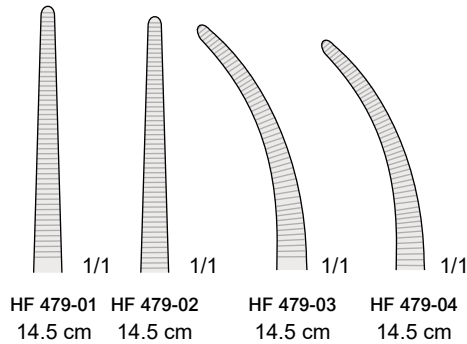
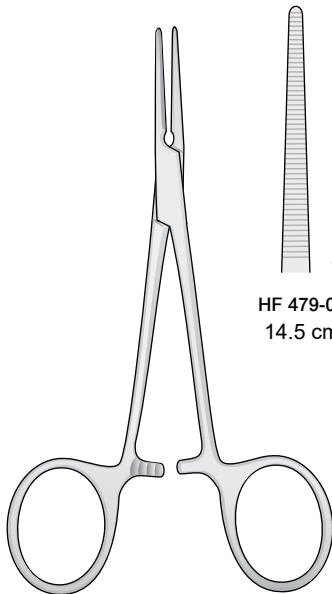

PEAN

HF 479-01 / HF 479-04

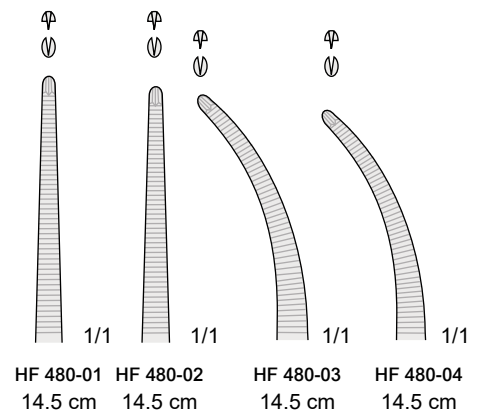
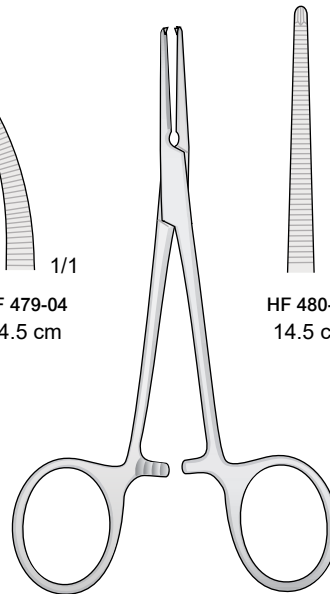

KOCHER

HF 480-01 / HF 480-04

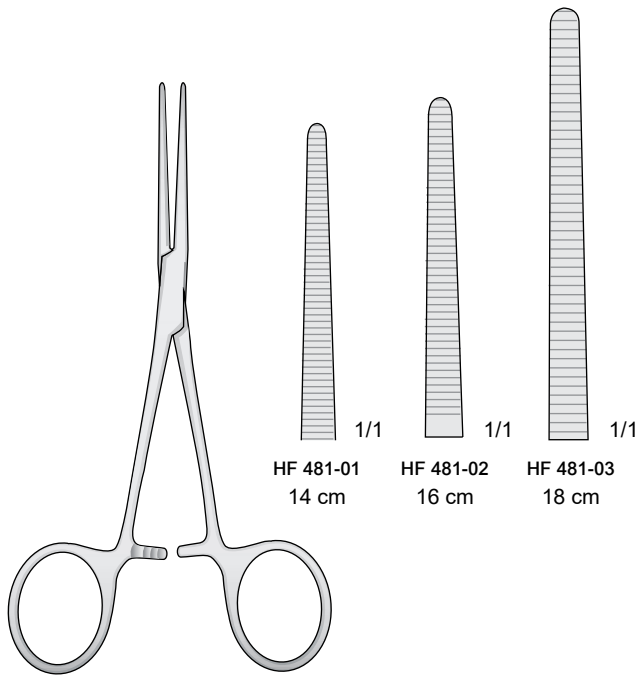

HF 481-01
14 cm

HF 481-02
16 cm

HF 481-03
18 cm

ROCHESTER-PEAN

HF 481-01 / HF 481-03

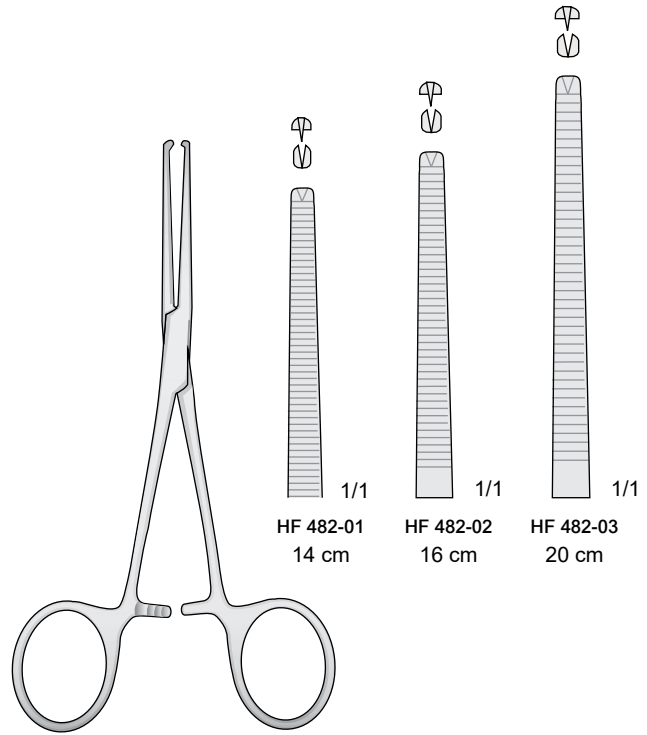

HF 482-01
14 cm

HF 482-02
16 cm

HF 482-03
20 cm

KOCHER-OCHSNER

HF 482-01 / HF 482-03

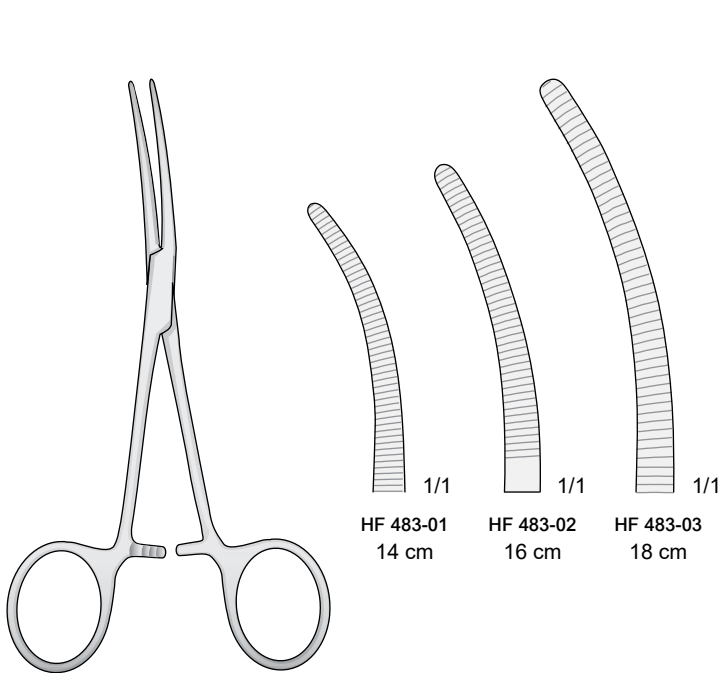

HF 483-01
14 cm

HF 483-02
16 cm

HF 483-03
18 cm

ROCHESTER-PEAN

HF 483-01 / HF 483-03

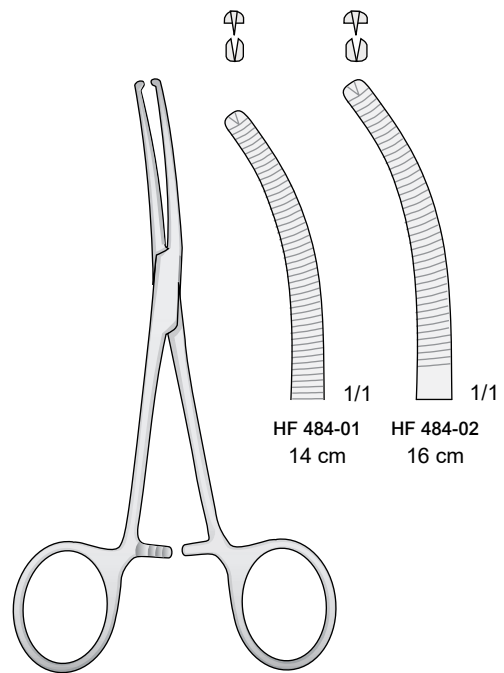

HF 484-01
14 cm

HF 484-02
16 cm

KOCHER-OCHSNER

HF 484-01 / HF 484-02

Pinze emostatic
 Hemostatic forcep
 Arterienklemme
 Pinces hémostatique
 Pinzas hemostáticas

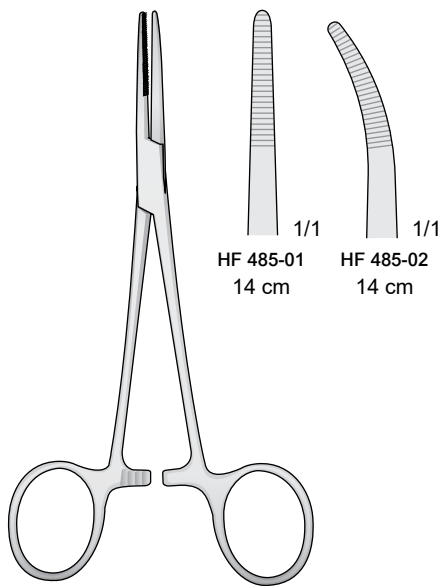

KELLY
HF 485-01 / HF 485-02

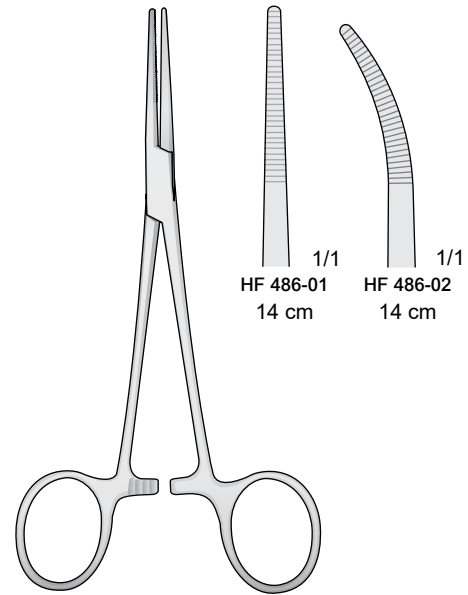

KELLY
HF 486-01 / HF 486-02

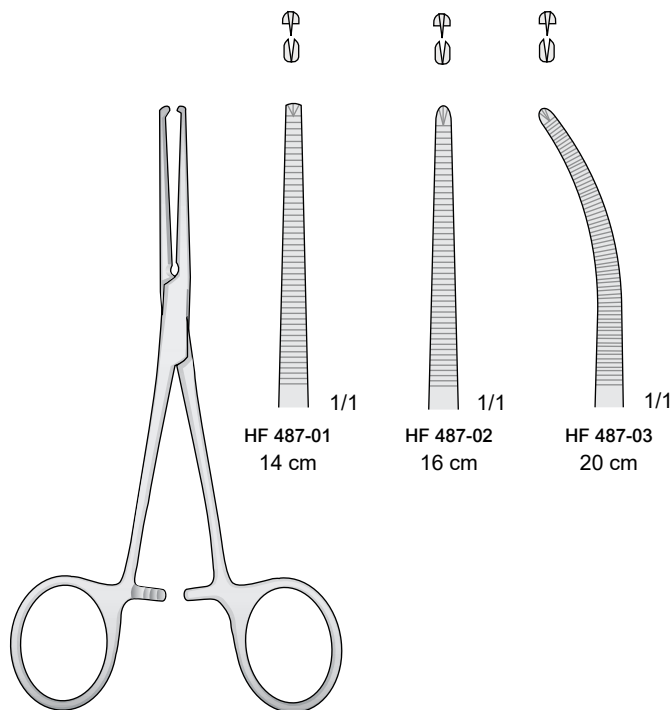

KOCHER
HF 487-01 / HF 487-03

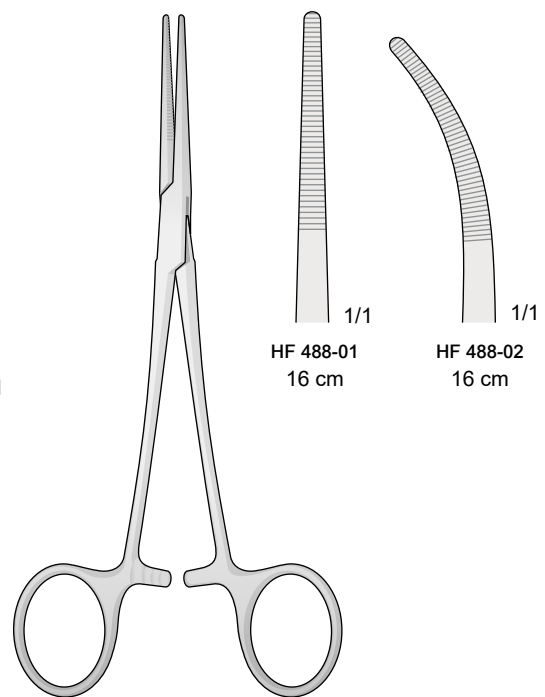

RANKIN
HF 488-01 / HF 488-02

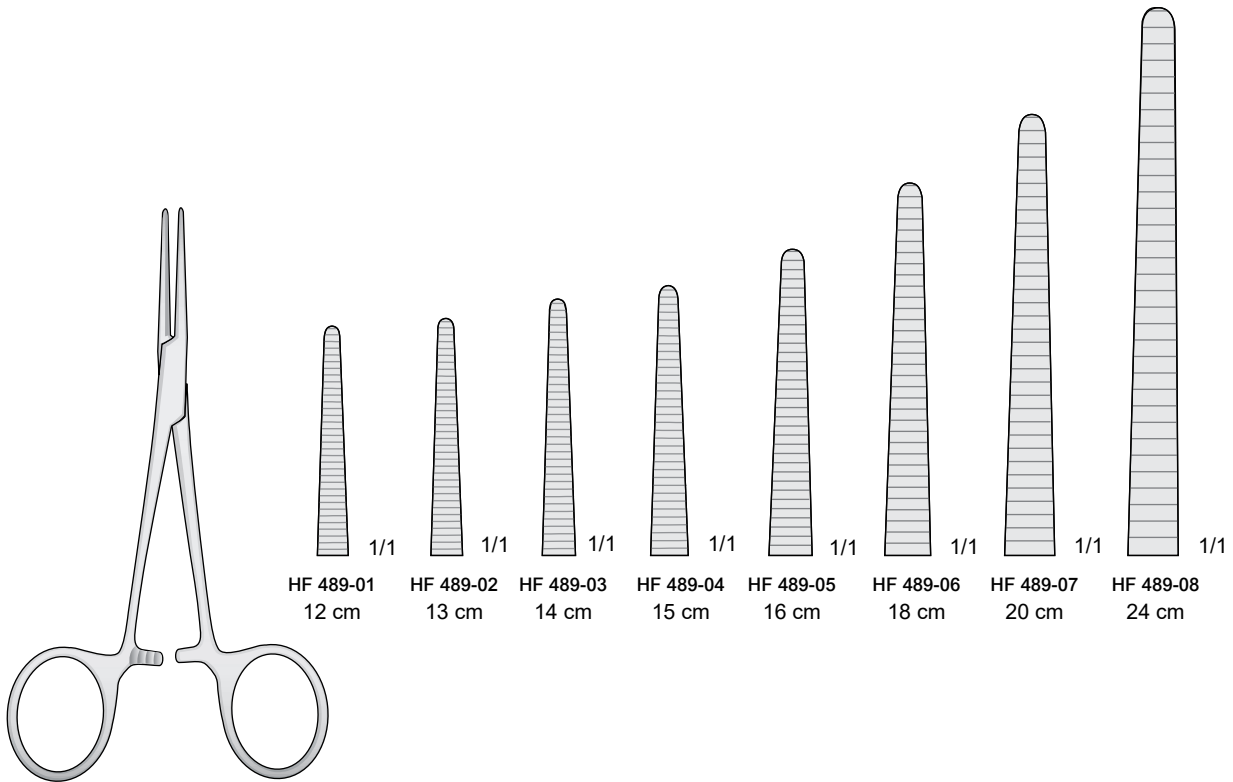

PEAN

HF 489-01 / HF 489-08

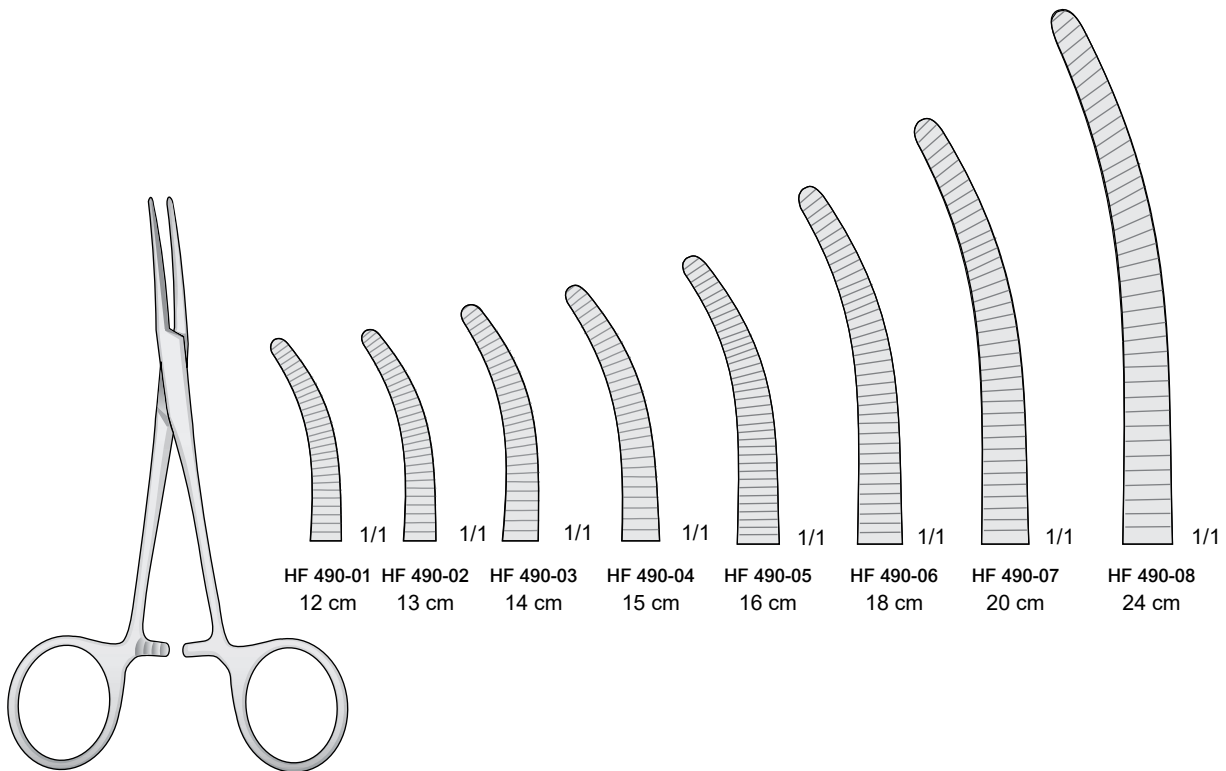

PEAN

HF 490-01 / HF 490-08

Pinze emostatic
 Hemostatic forcep
 Arterienklemme
 Pinces hémostatique
 Pinzas hemostáticas

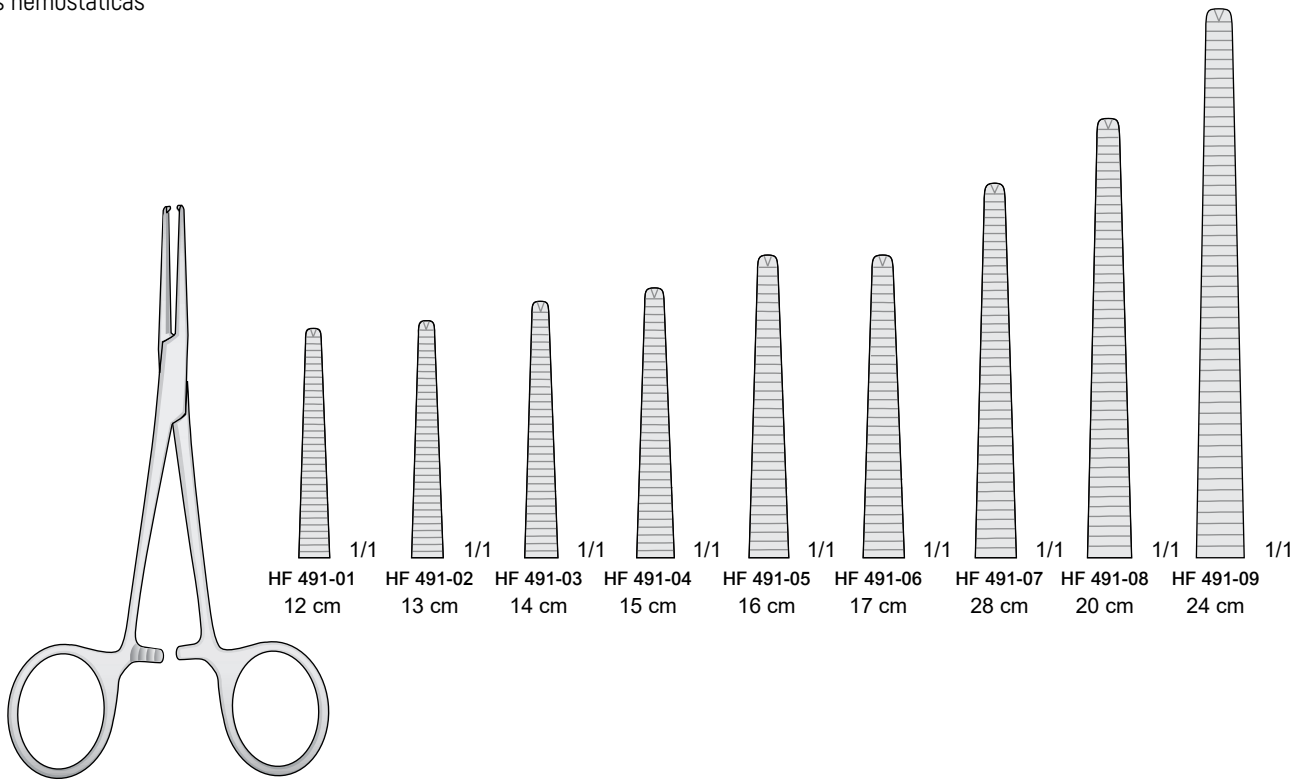

KOCHER

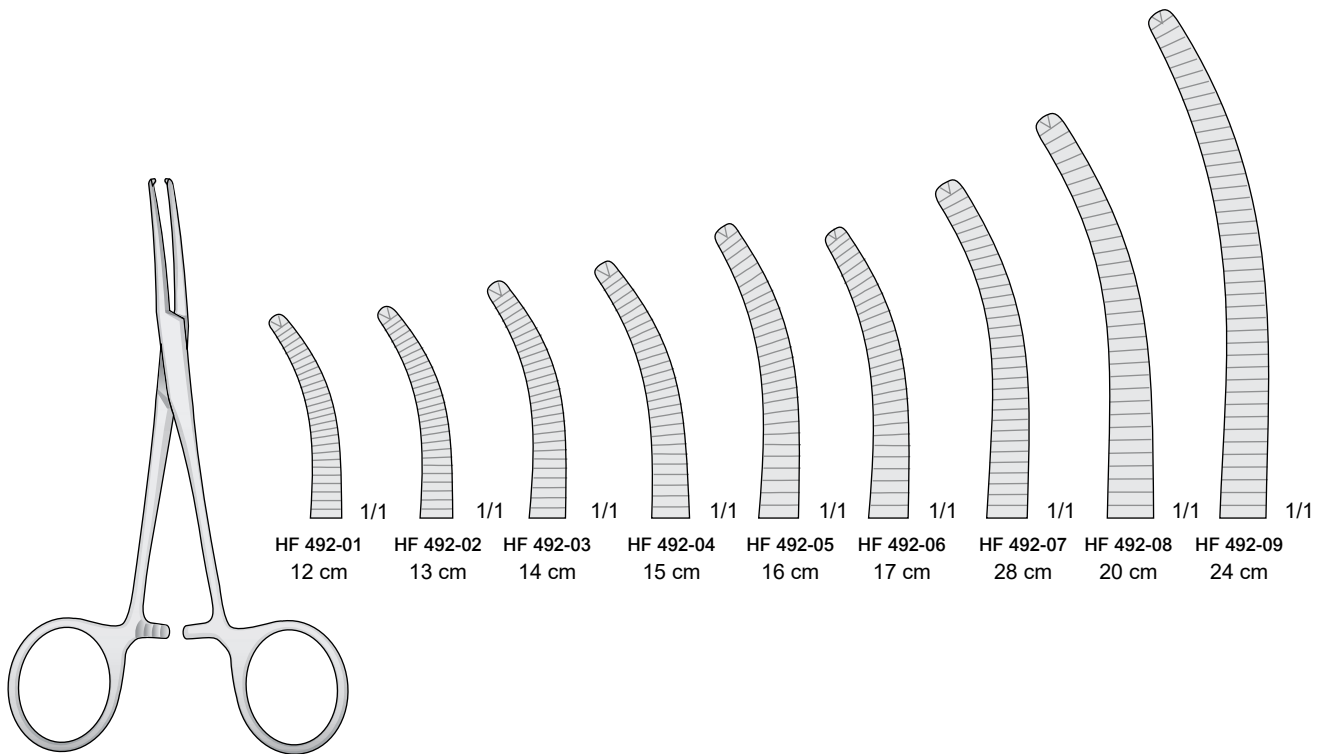

KOCHER

HF 492-01 / HF 492-09

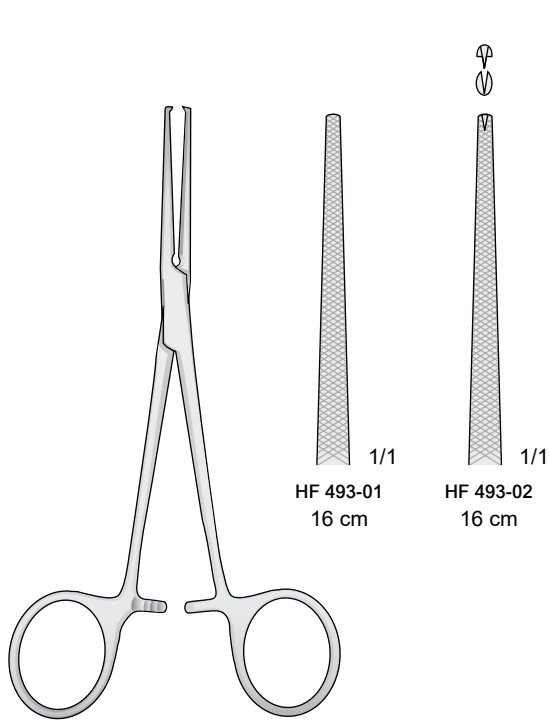

DIXON-LOVELACE
HF 493-01 / HF 493-02

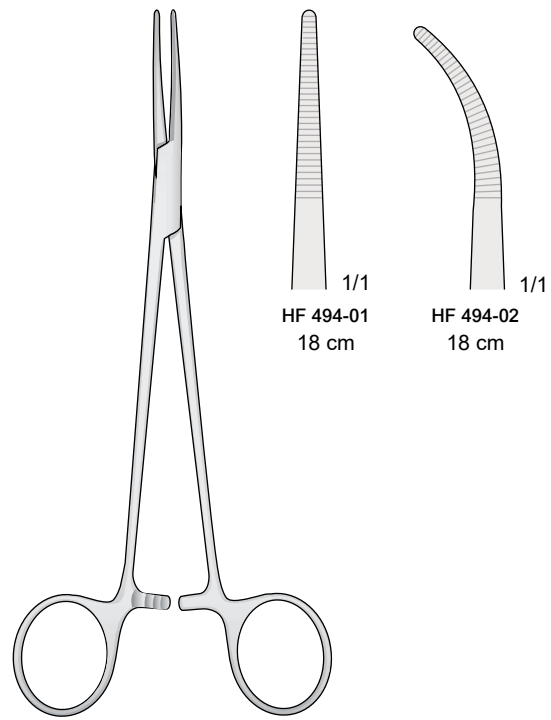

BIRKETT
HF 494-01 / HF 494-02

Pinza per peritoneo - Peritoneal clamps forceps
Pritoneum klemmen - Pincas-camps pour les péritoine
Pinzas-clamps para peritoneo

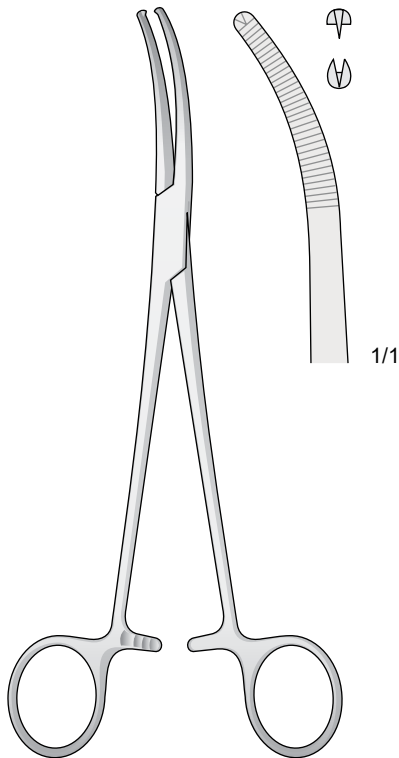

MIKULICZ
HF 495-19 19 cm

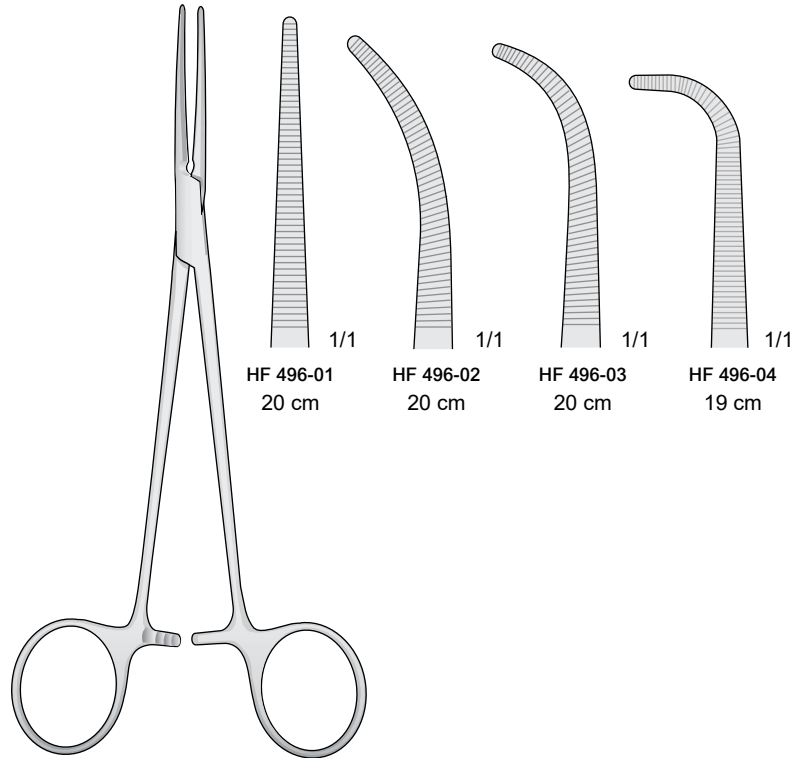

HEISS
HF 496-01 / HF 496-04

Pinze emostatic
 Hemostatic forcep
 Arterienklemme
 Pinces hémostatique
 Pinzas hemostáticas

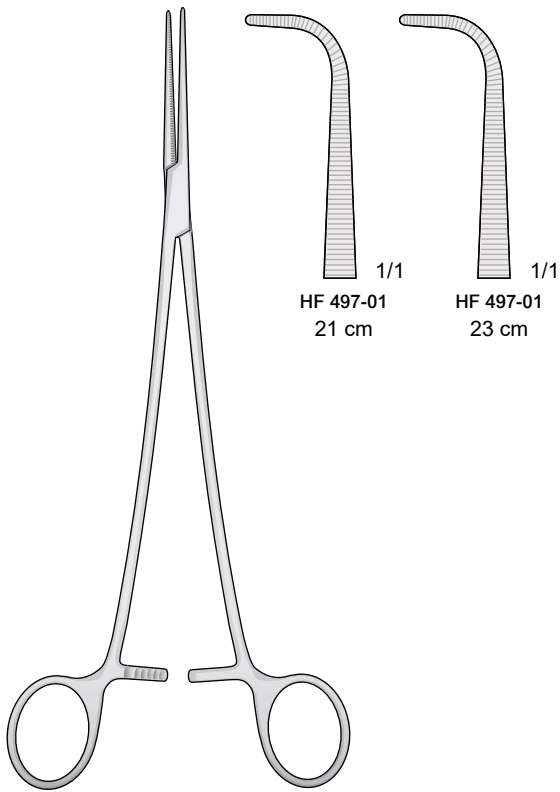

BENGOLEA
HF 497-01 / HF 497-02

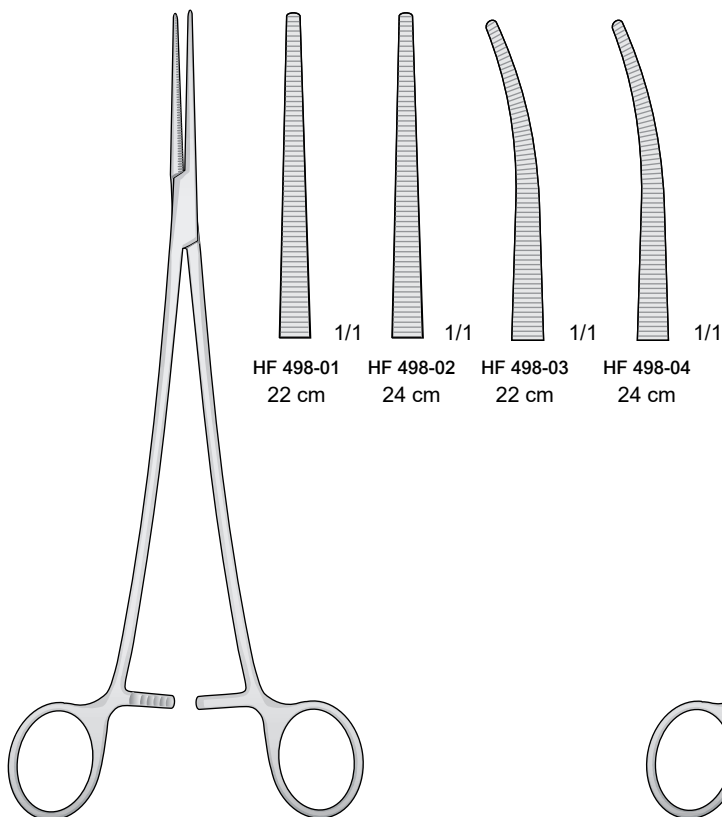

BENGOLEA
HF 498-01 / HF 498-04

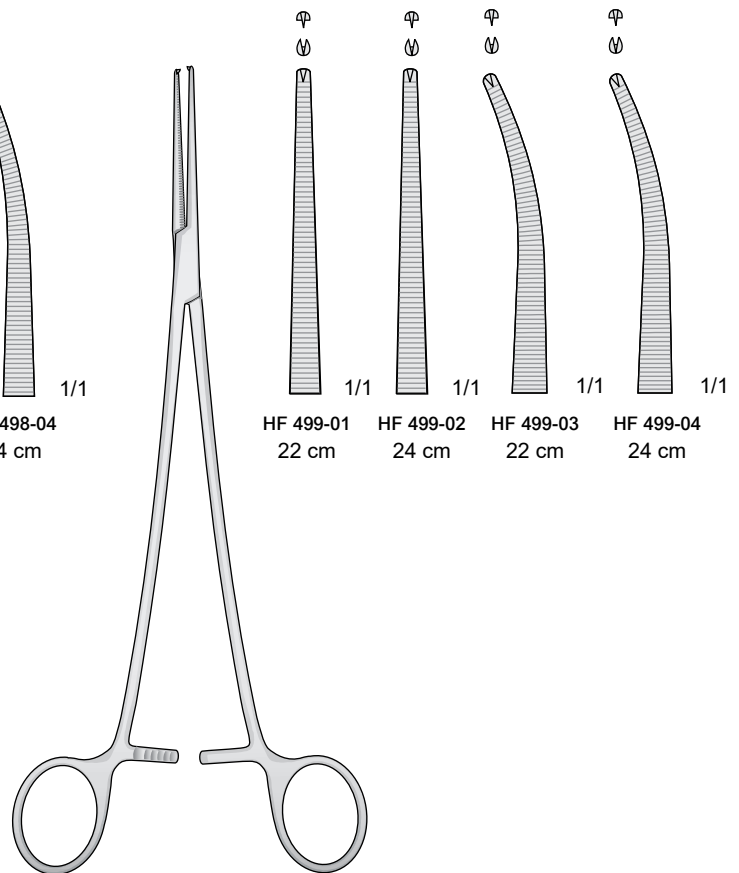

BENGOLEA
HF 499-01 / HF 499-04



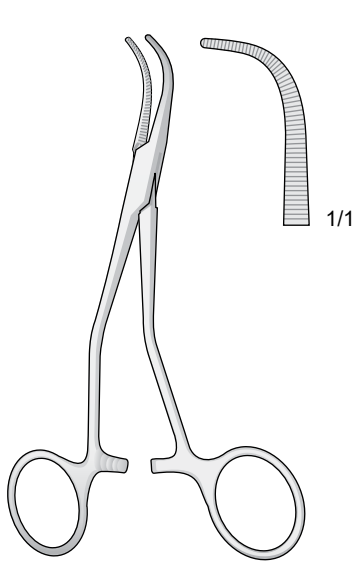

AFP 500-13 13 cm

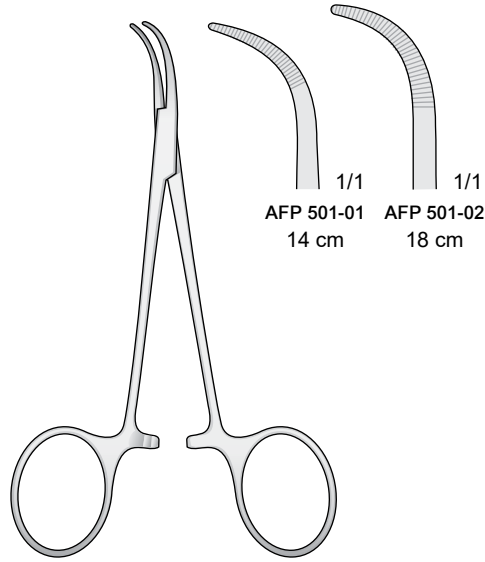

BABY-MIXTER
AFP 501-01 / AFP 501-02

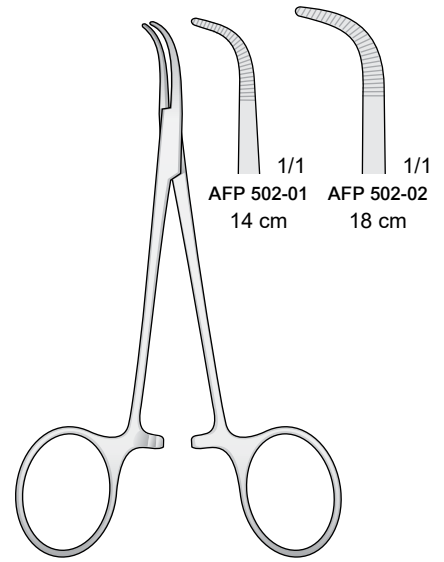

BABY-ADSON
AFP 502-01 / AFP 502-02

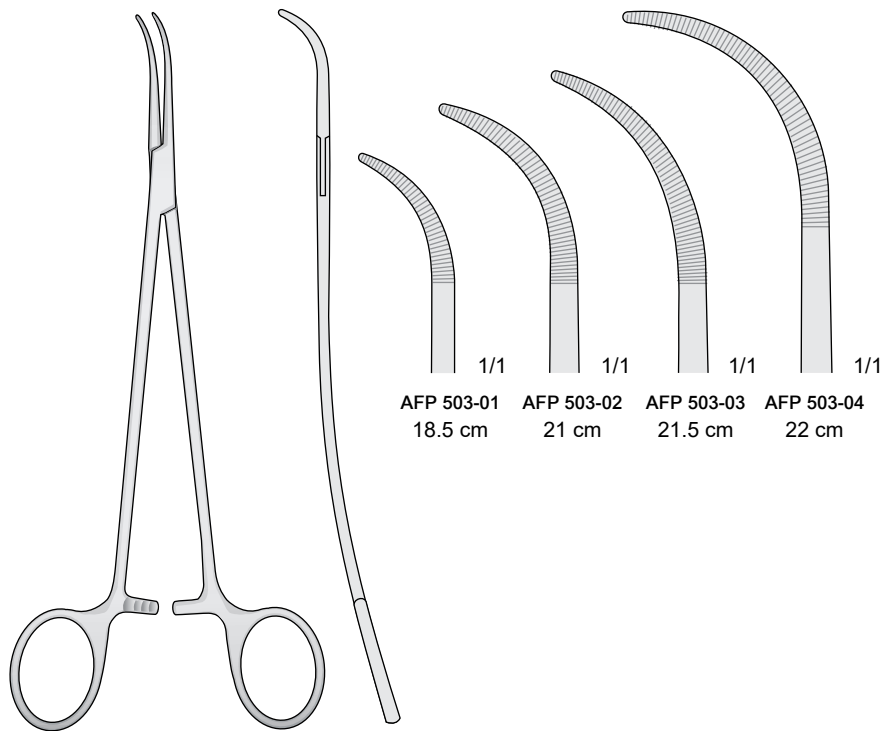

AFP 503-01 / AFP 503-04

Pinze emostatiche per preparazioni e legature
 Artery forceps for preparation and ligature
 Arterienklemmen Präparier und Ligaturklemmen
 Pinces hémostatiques à disséquer et à ligatures
 Pinzas hemostáticas Preparación y para ligaduras

Passafili

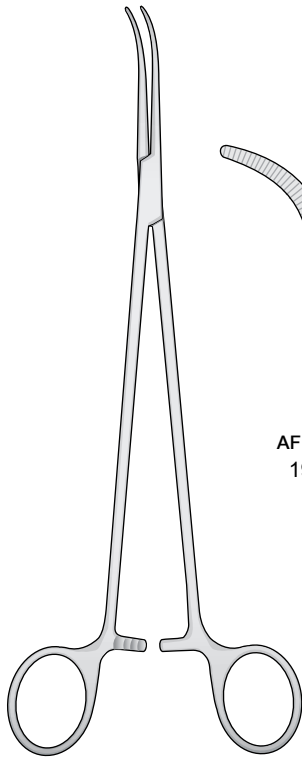

OVERHOLT-GEISSENDORFER
AFP 504-01 / AFP 504-12

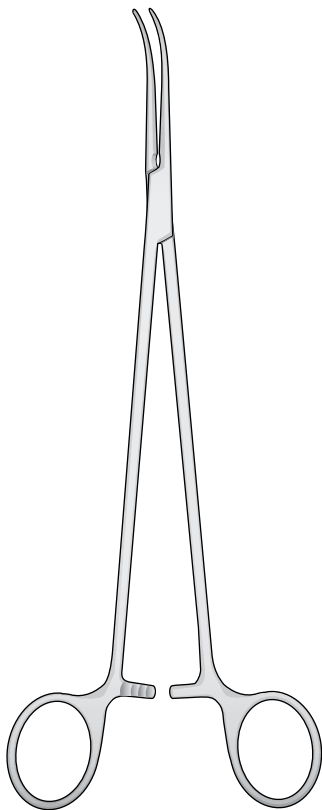
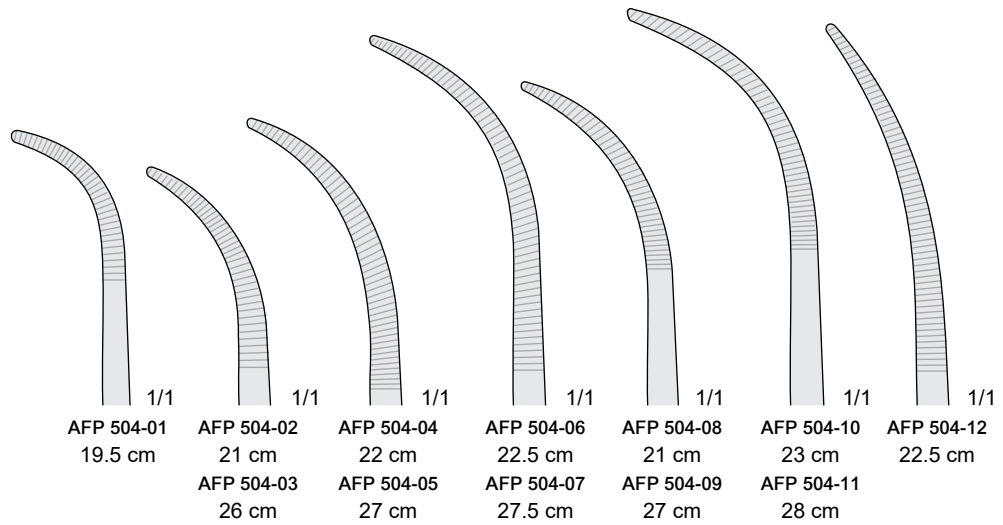

OVERHOLT
AFP 505-01 / AFP 505-10

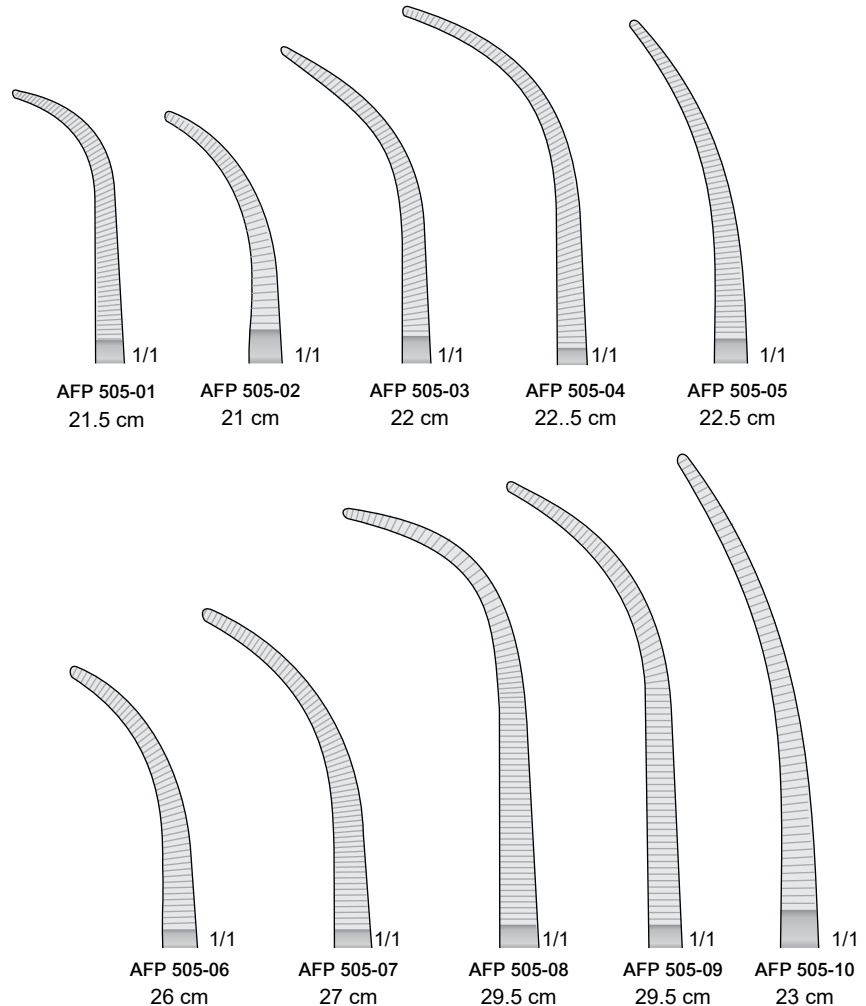

Pinze emostatiche per preparazioni e legature
 Artery forceps for preparation and ligature
 Arterienklemmen Präparier und Ligaturklemmen
 Pinces hemostatiques à disséquer et à ligatures
 Pinzas hemostáticas Preparacion y para ligaduras

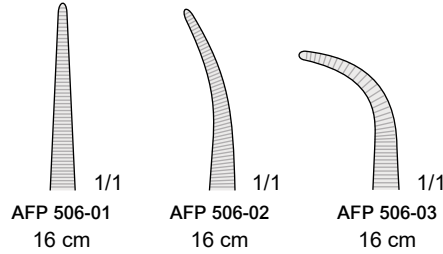
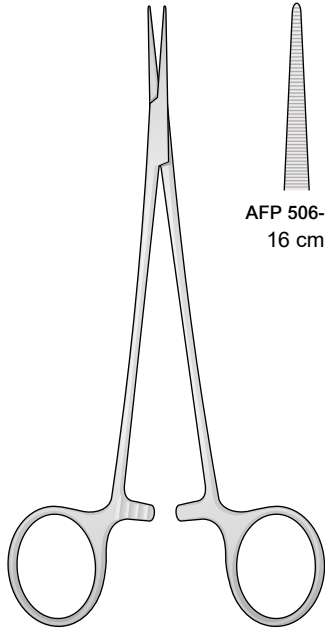

AFP 506-01 / AFP 506-03

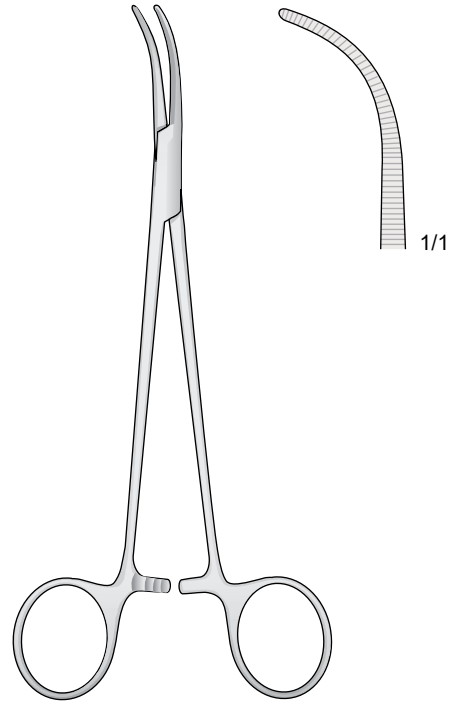

ROCHESTER-PEAN

AFP 507-18 18 cm

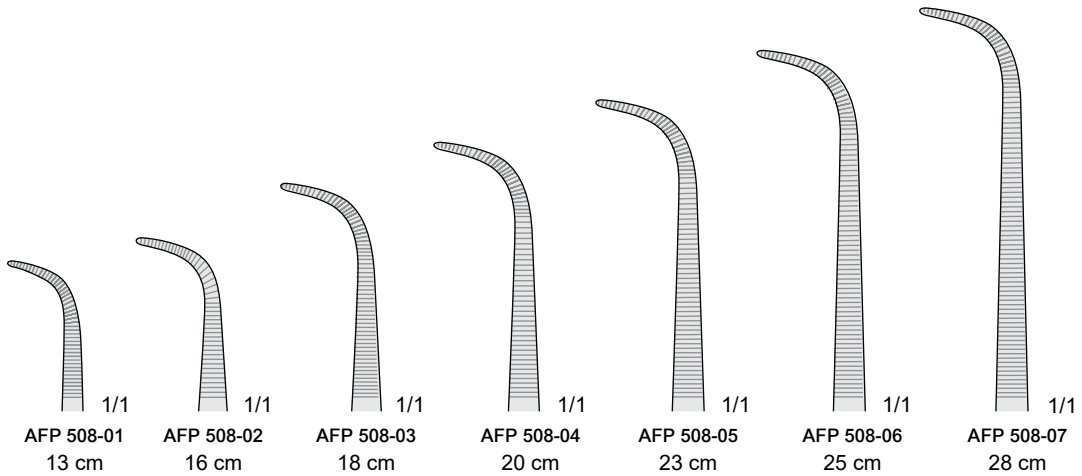
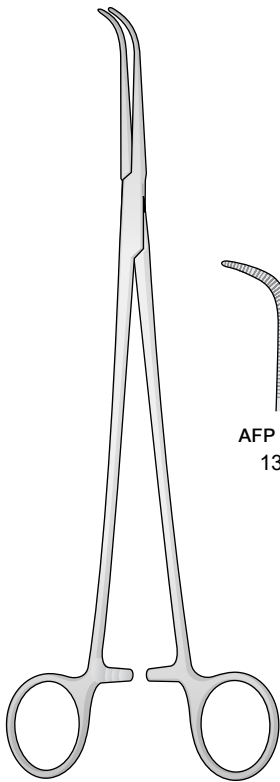

GEMINI

AFP 508-01 / AFP 508-07

Pinze emostatiche per preparazioni e legature
Artery forceps for preparation and ligature
Arterienklemmen Präparier und Ligaturklemmen
Pincés hemostàtiques à disséquer et à ligatures
Pinzas hemostáticas Preparacion y para ligaduras

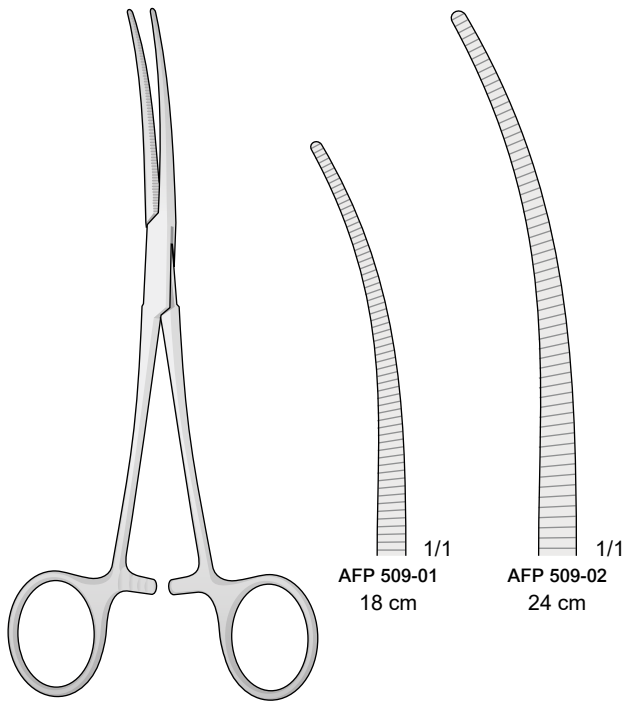

CRAFOORD

AFP 509-01 / AFP 509-02

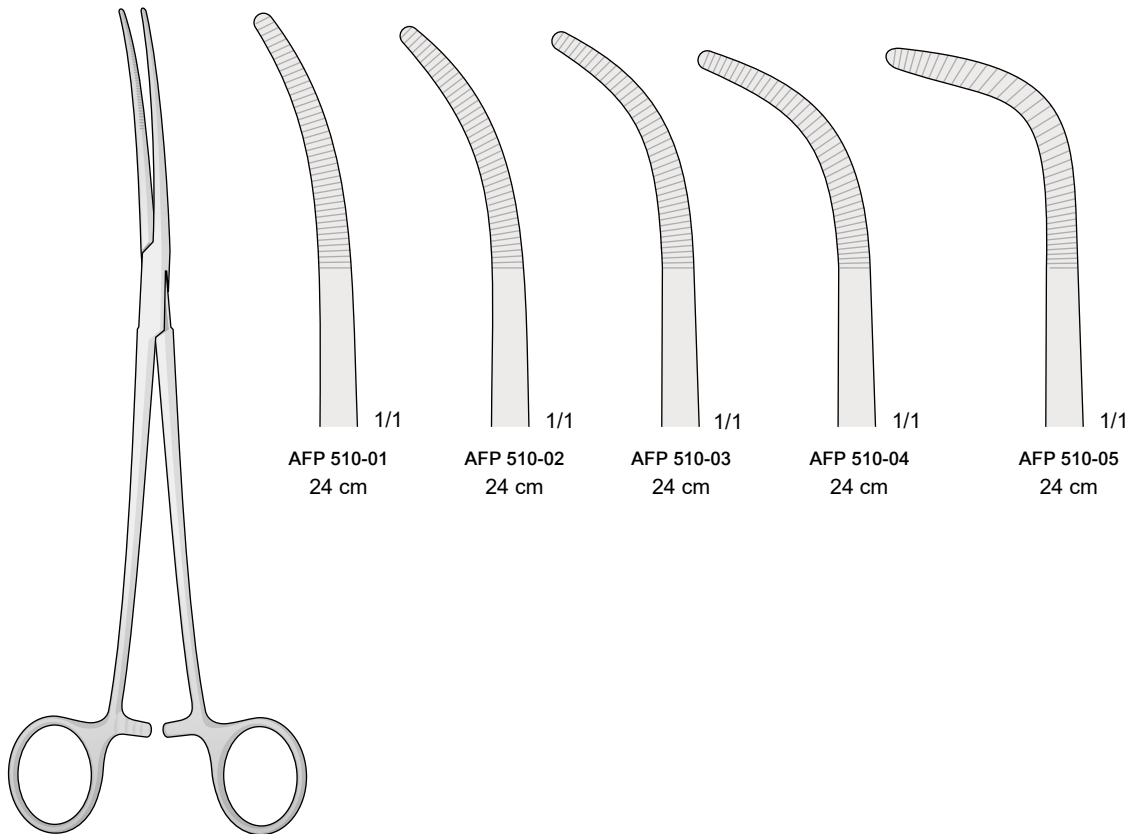

RUMEL

AFP 510-01 / AFP 510-05

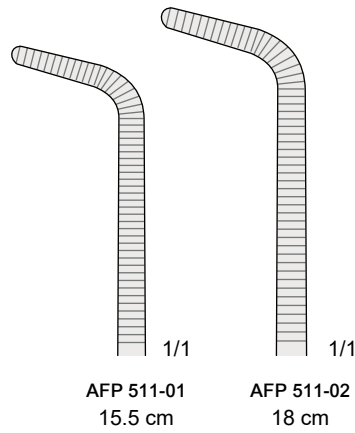
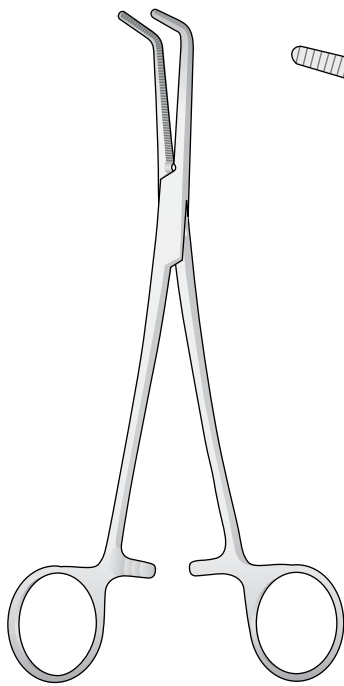

MIXTER
AFP 511-01 / AFP 511-02

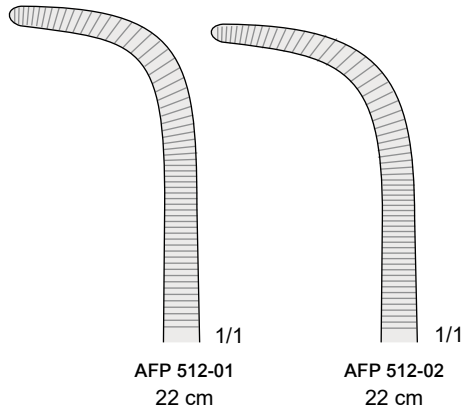
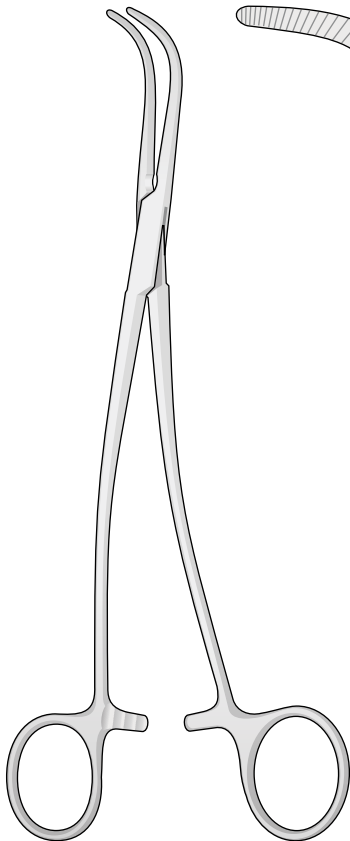

GRAY
AFP 512-01 / AFP 512-02

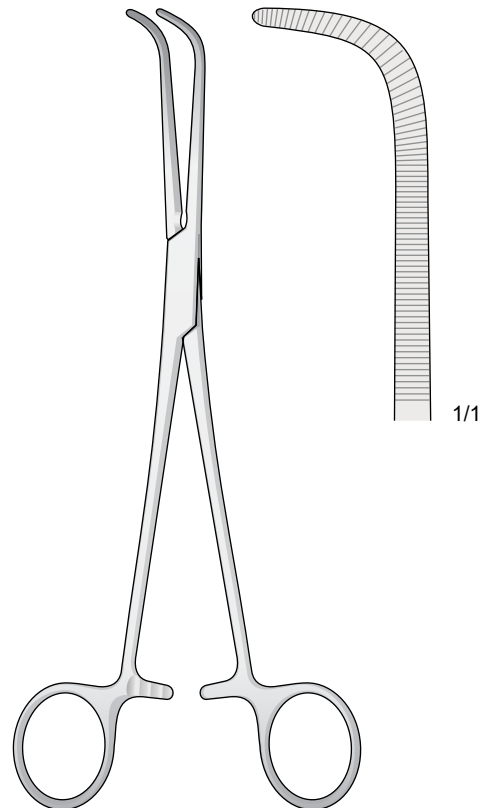

WIKSTROEM
AFP 513-20 2.5 cm

Pinze emostatiche per preparazioni e legature
 Artery forceps for preparation and ligature
 Arterienklemmen Präparier und Ligaturklemmen
 Pinces hémostatiques à disséquer et à ligatures
 Pinzas hemostáticas Preparación y para ligaduras

Pinze per tonsille
 Tonsil forceps
 Tonsillenklemmen
 Pinces pour amygdales
 Pinzas para amígdalas

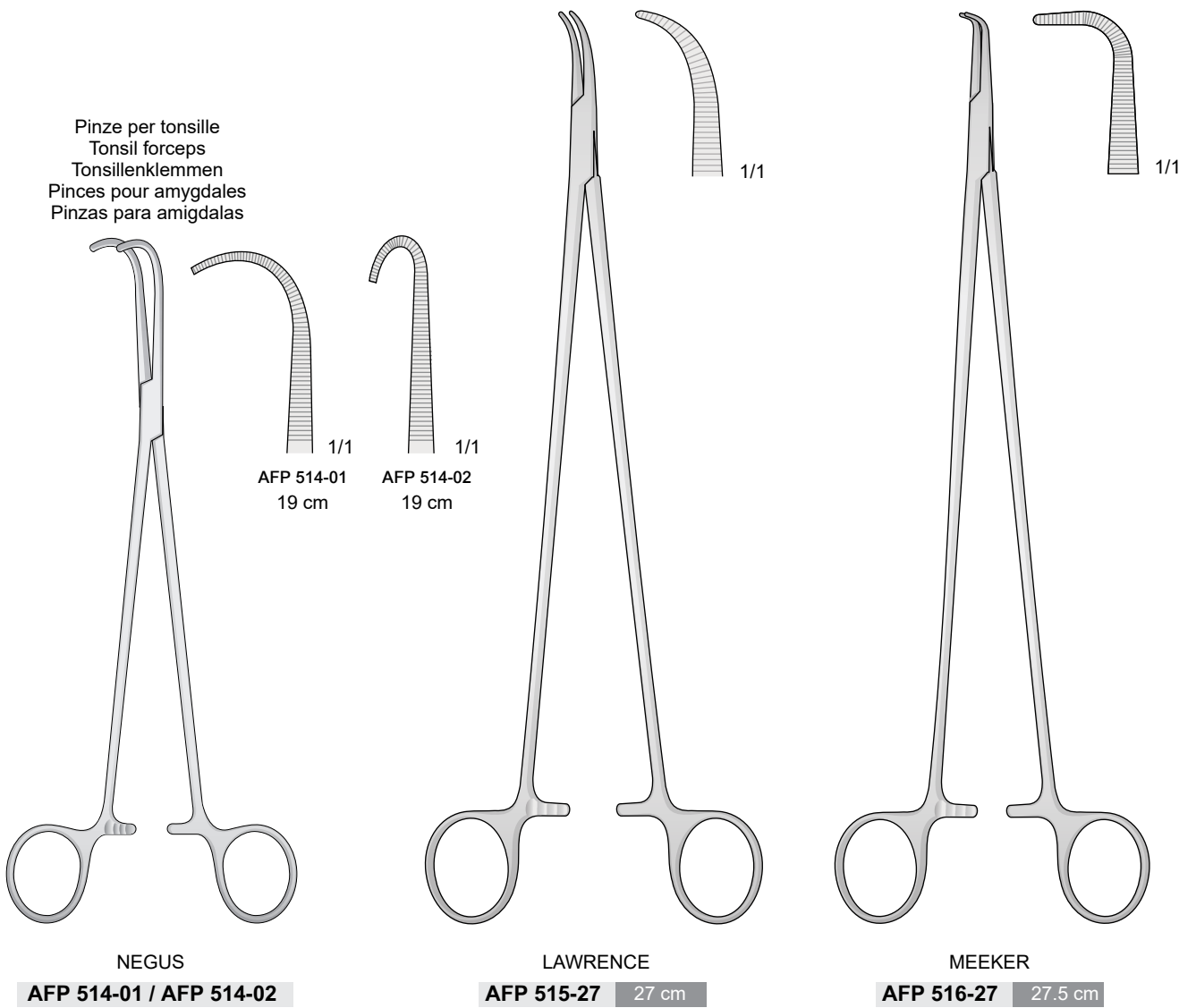

NEGUS

AFP 514-01 / AFP 514-02

LAWRENCE

AFP 515-27 27 cm

MEEKER

AFP 516-27 27.5 cm

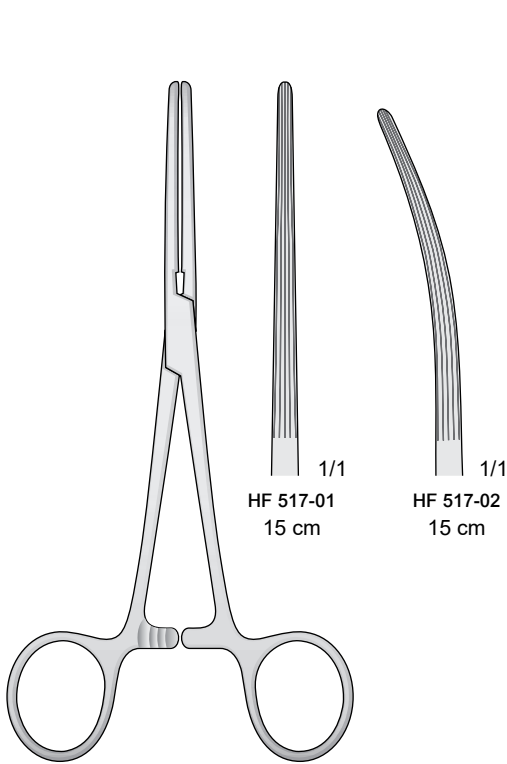

BAINBRIDGE
HF 517-01 / HF 517-02

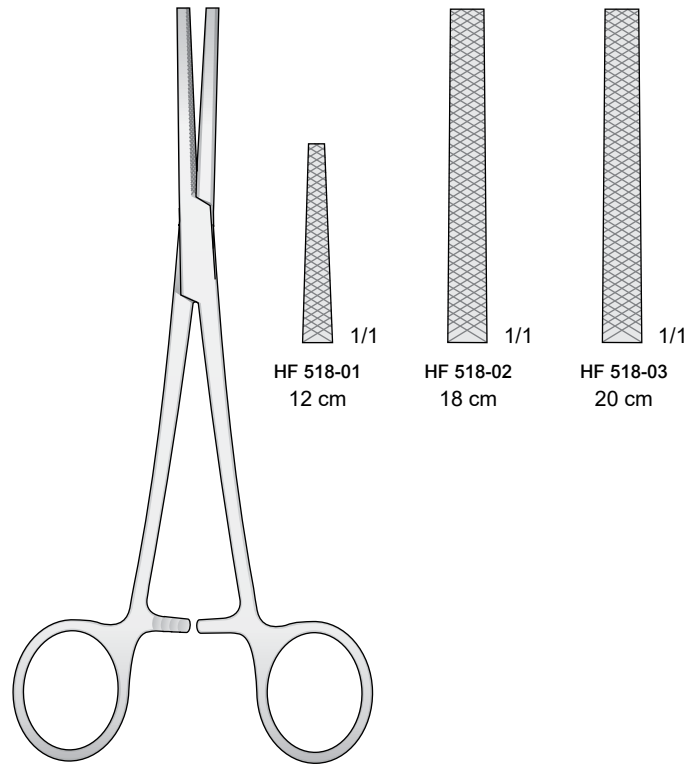

HF 518-01 / HF 518-03

Angiotribe - Druckklemmen
Angiotribes - Pincas-clamps para presión progresiva

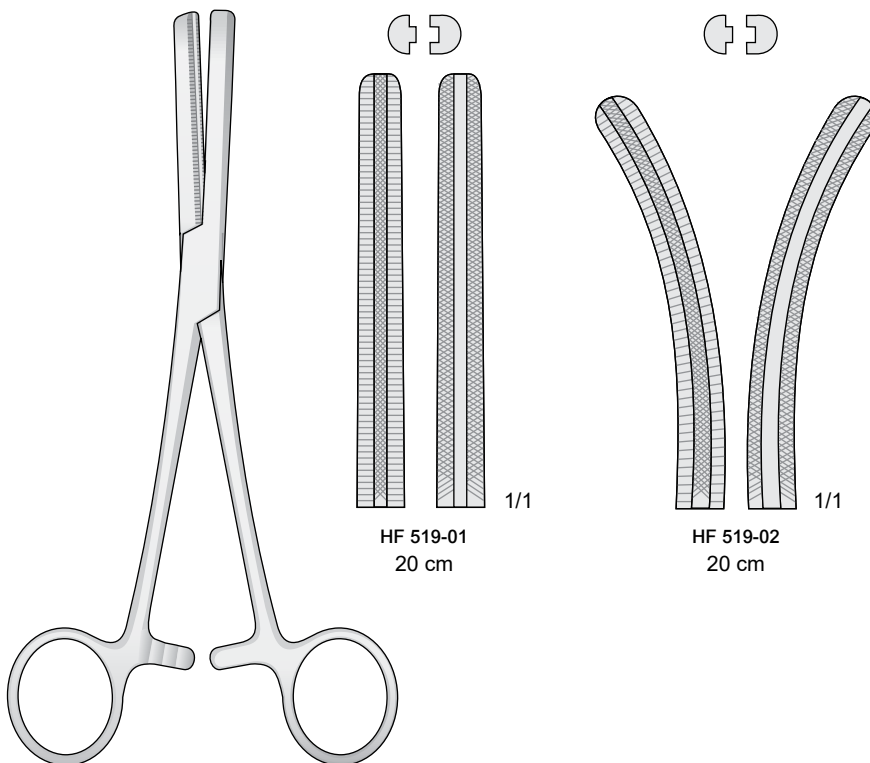

FERGUSON
HF 519-01 / HF 519-02

Pinze serratub
Tubing Clamp
Schlauchklemme
Pincas presse-tube
Pinzas cierra-tubos

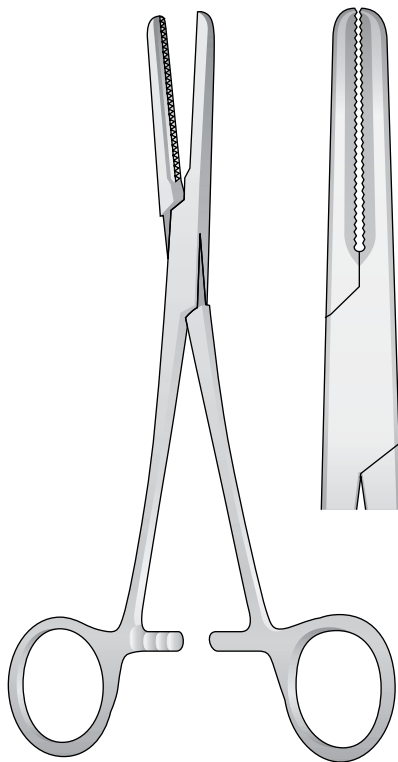

TC 520-01 / TC 520-03

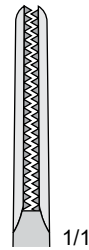

TC 520-01
15 cm

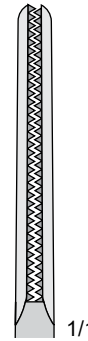

TC 520-02
18 cm

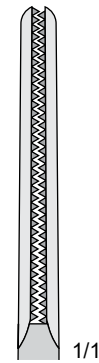

TC 520-03
20 cm

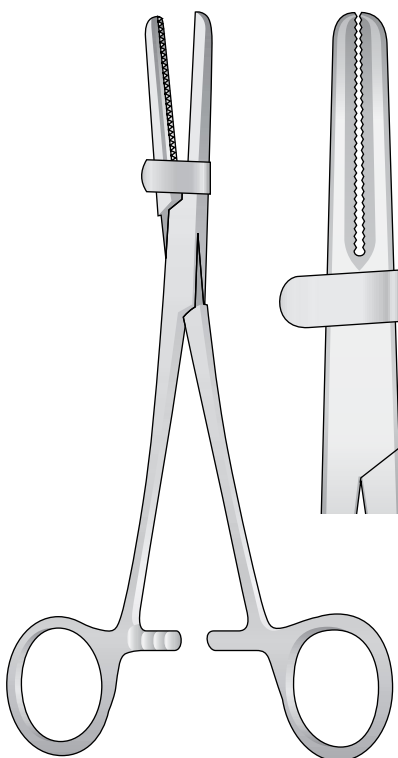

TC 521-01 / TC 521-03

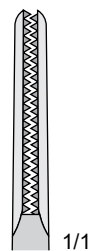

TC 521-01
15 cm

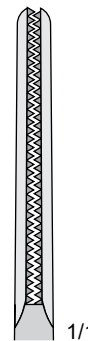

TC 521-02
18 cm

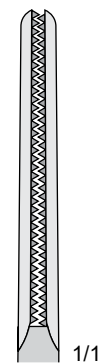

TC 521-03
20 cm

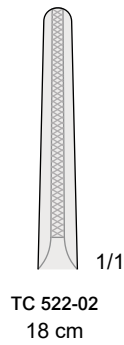
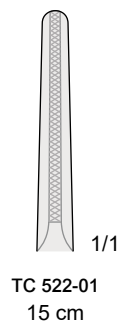
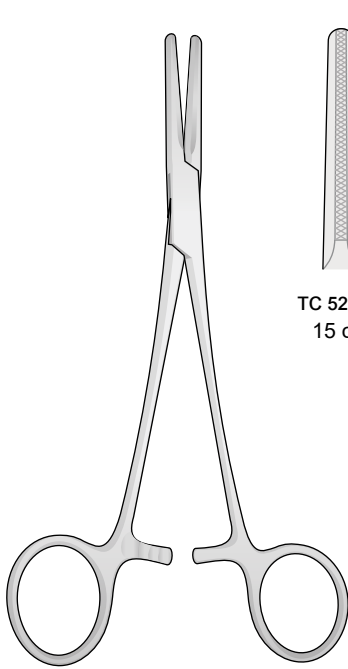

TC 522-01 / TC 522-02

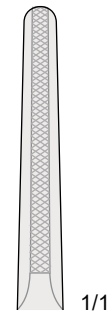
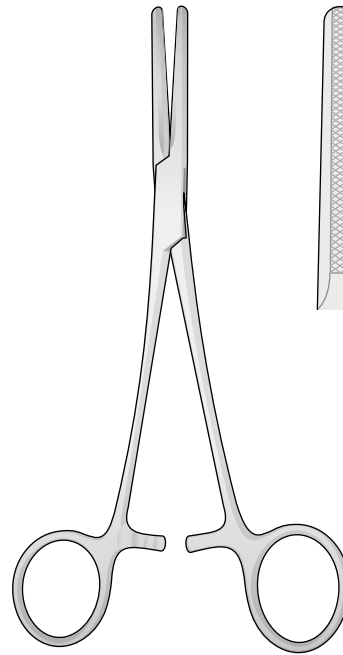

TC 523-18 18 cm

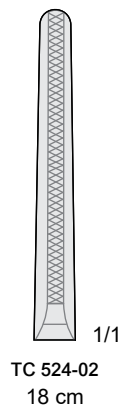
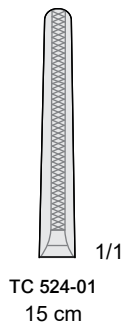
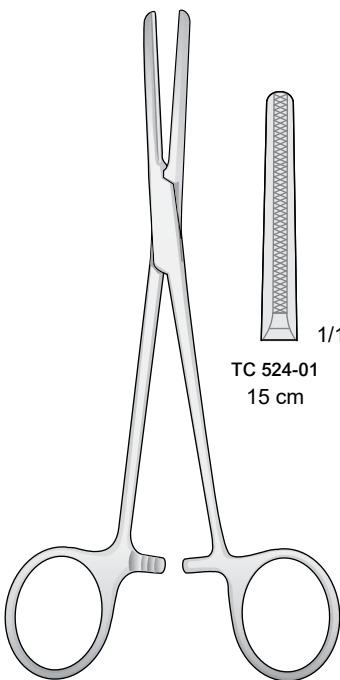

TC 524-01 / TC 524-02

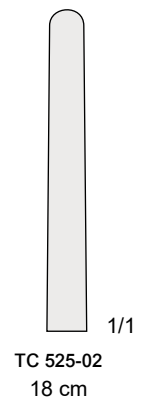
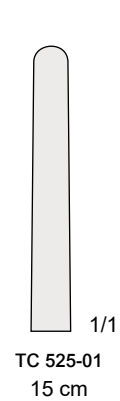
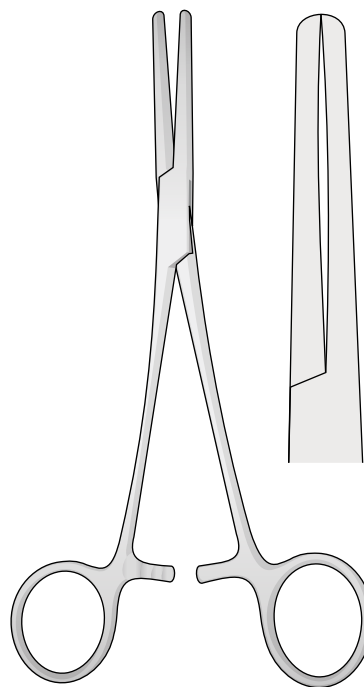

TC 525-01 / TC 525-02



we take a closer look

Atraumatic Vascular Clamps



Atraumatische Gefäßklemmen
Pinces vasculaires atraumatiques
Pinzas vasculares atraumáticas
Pinze vascolari atraumatiche

Atraumatiche - Atraumatic
Atraumatische - Atraumatiques - Atraumáticas

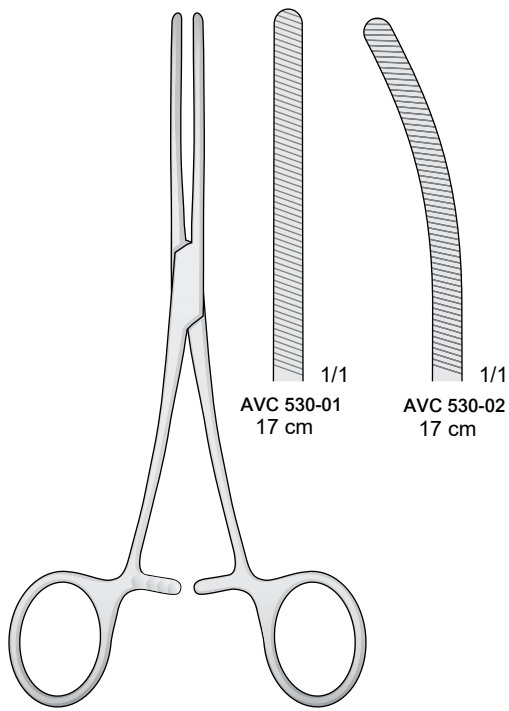

DOYEN
AVC 530-01 / AVC 530-02

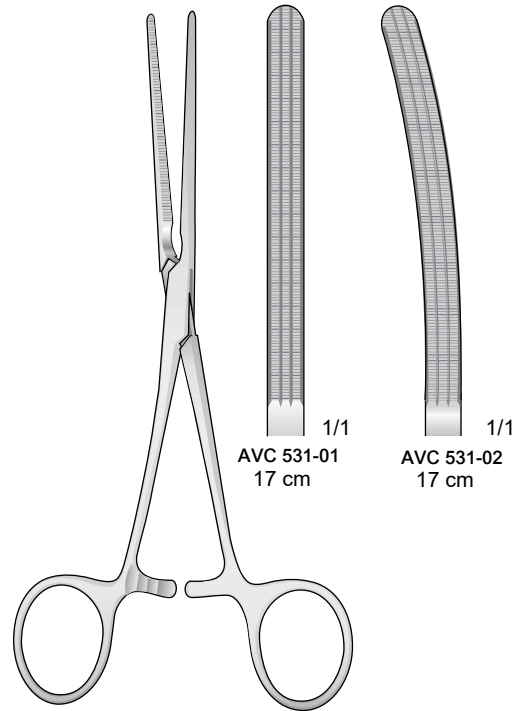

DOYEN
AVC 531-01 / AVC 531-02

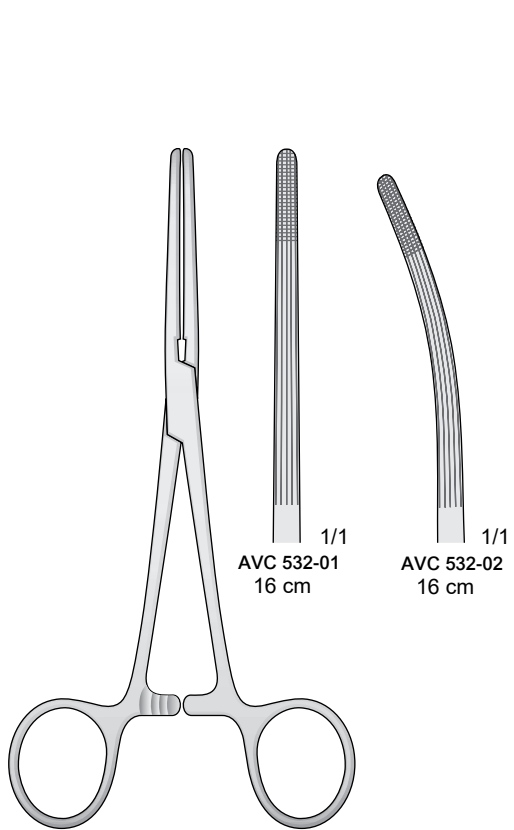

ROCHESTER-CARMALT
AVC 532-01 / AVC 532-02

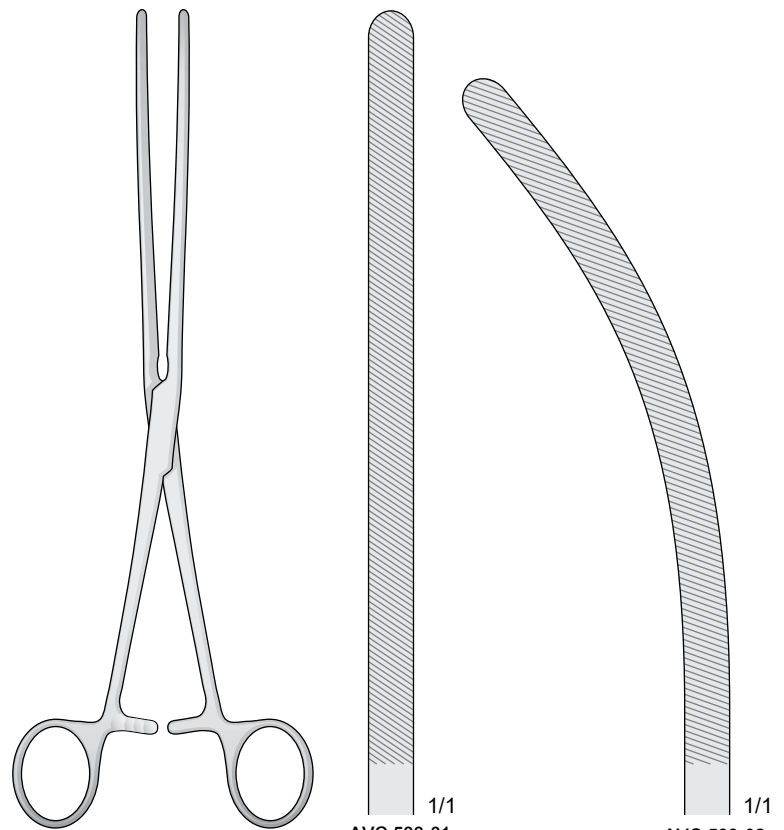

DOYEN
AVC 533-01 / AVC 533-02

Pinze intestinali elastiche
Intestinal clamps soft elastic
Darmklemmen Elastisch
Pincas intestinales
Pinzas intestinales

Elastiche - Elastisch - Elastich - Elastic - Elasticas

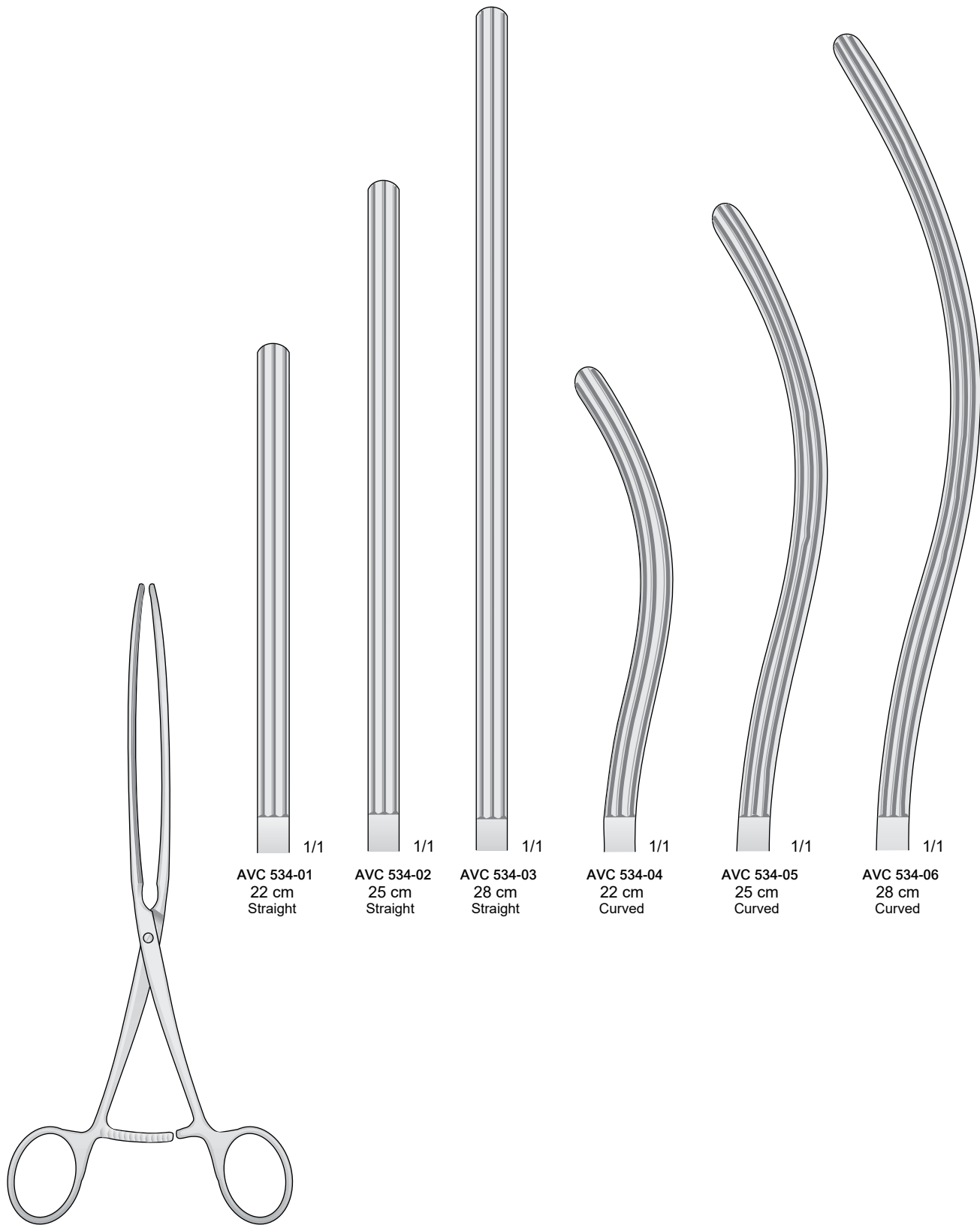

KOCHER

AVC 534-01 / AVC 534-06



Atraumatiche - Atraumatic
Atraumatische - Atraumatiques - Atraumáticas

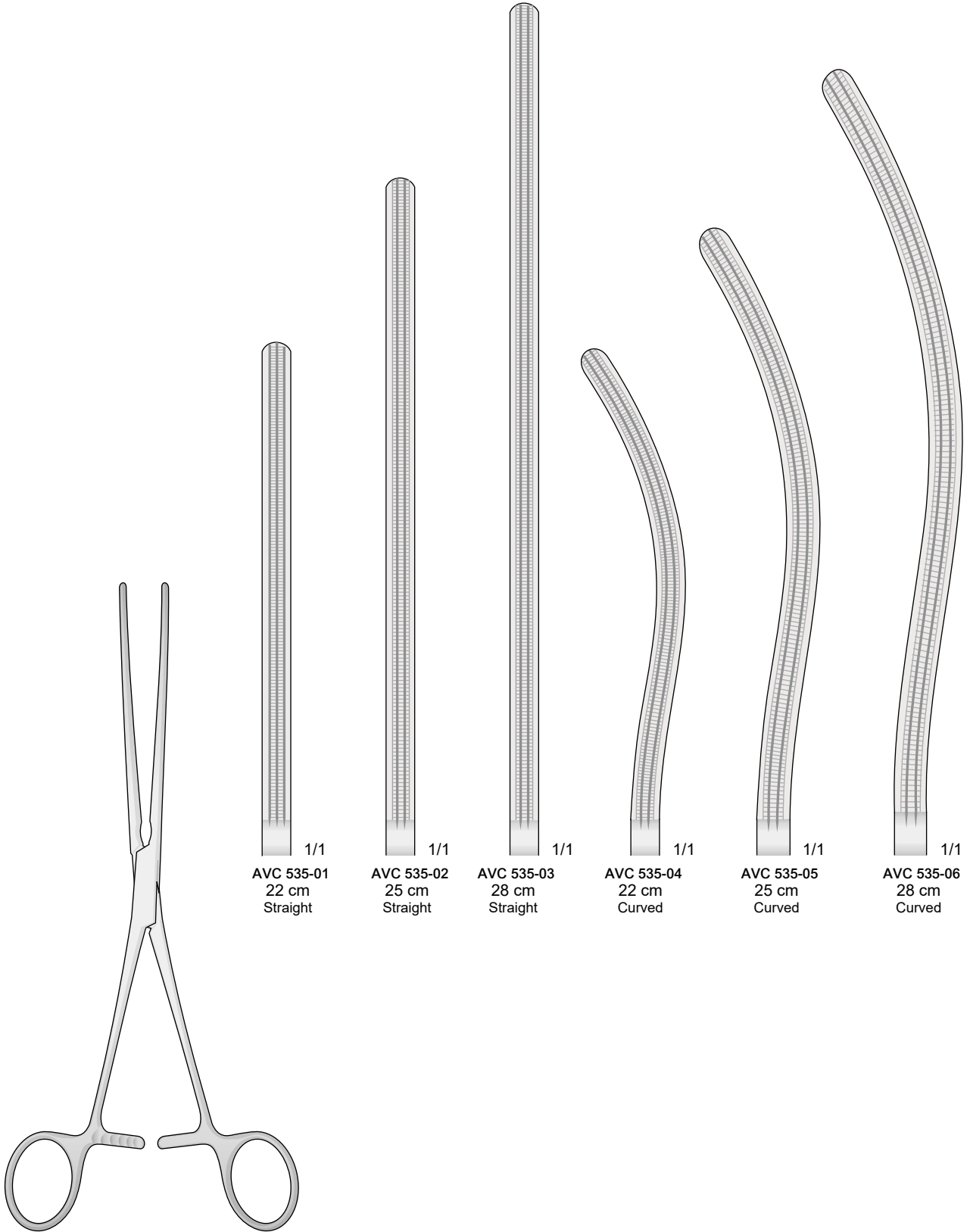

KOCHER

AVC 535-01 / AVC 535-06

AVC 535-01
22 cm
Straight

AVC 535-02
25 cm
Straight

AVC 535-03
28 cm
Straight

AVC 535-04
22 cm
Curved

AVC 535-05
25 cm
Curved

AVC 535-06
28 cm
Curved

Pinze per intestino e stomaco
 Intestinal-stomach clamps
 Darm-magen Gefäßklemmen
 Pincers-clamps pour l'intestin et l'estomac
 Pinzas intestinales stomacales

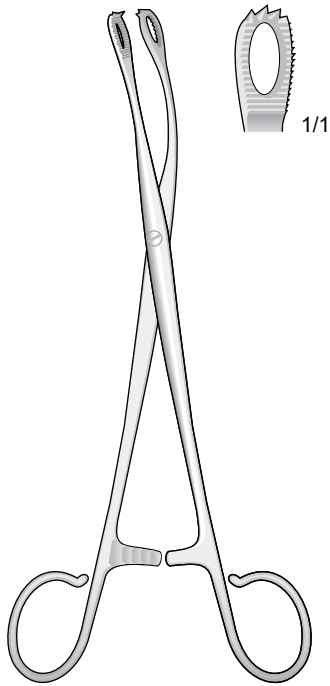

BLOHMKE
AVC 536-20 20 cm

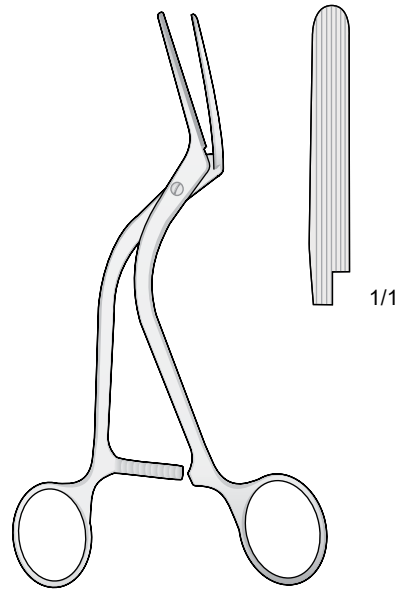

HÖPFNER
AVC 537-16 16.5 cm

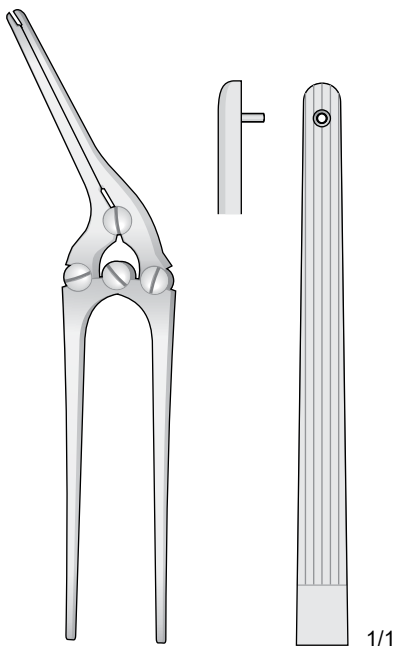

PAYR
AVC 538-20 20 cm

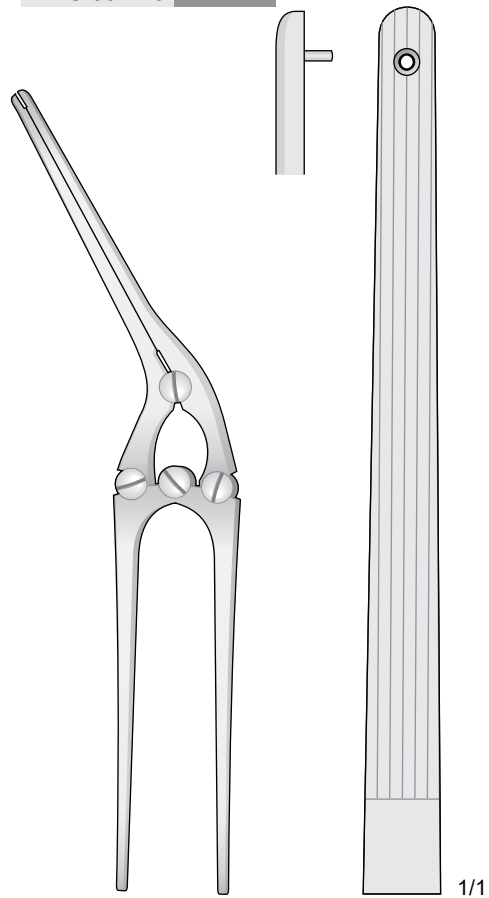

PAYR
AVC 539-28 28 cm

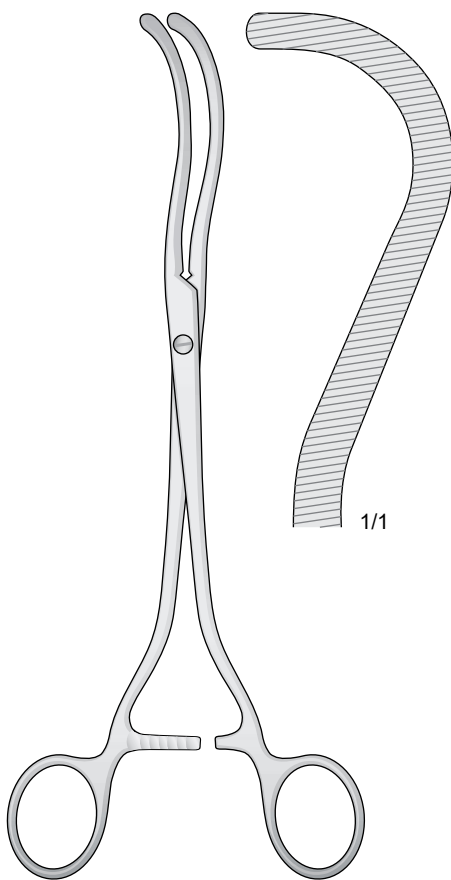

GUYON

AVC 540-23 23.5 cm

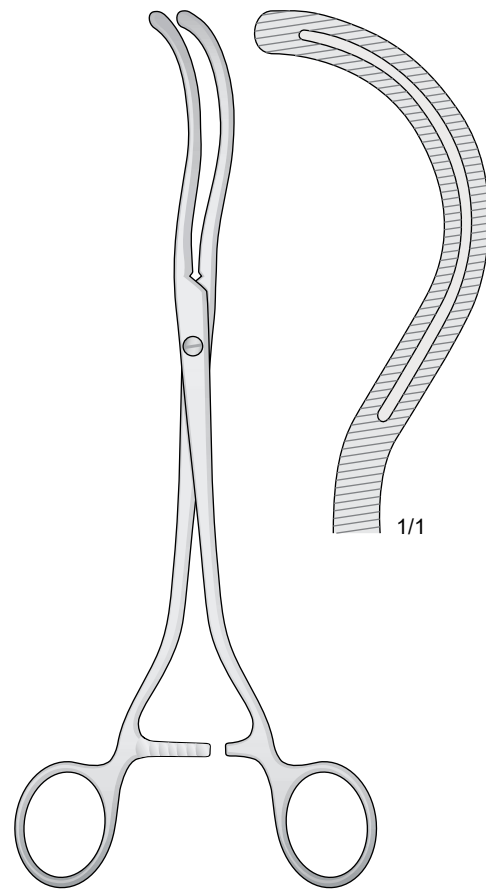

STILLE

AVC 541-24 24 cm

Pinze per peduncoli renali
Kidney pedicle clamps forceps
Nierenstielklemmen
Pinces-clamps pour pédicules rénaux
Pinzas clamps para pedúncolos renales

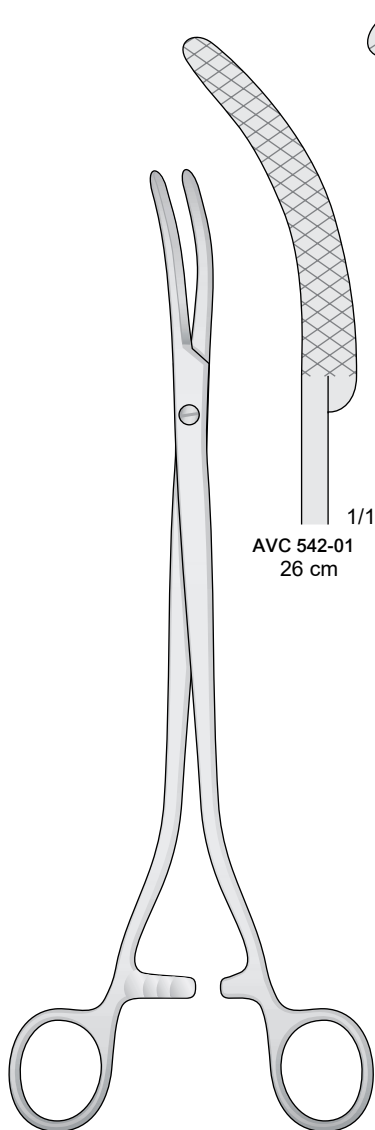

AVC 542-01
26 cm

WERTHEIM

AVC 542-01 / AVC 542-02

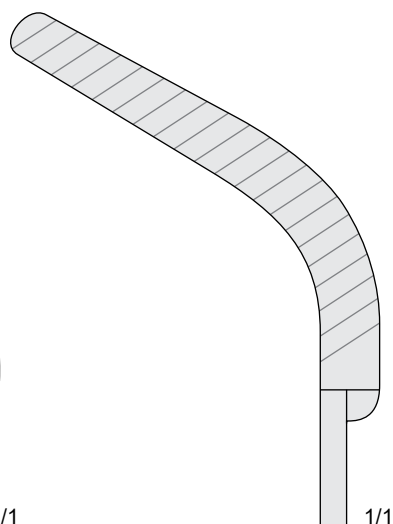

AVC 542-02
26 cm

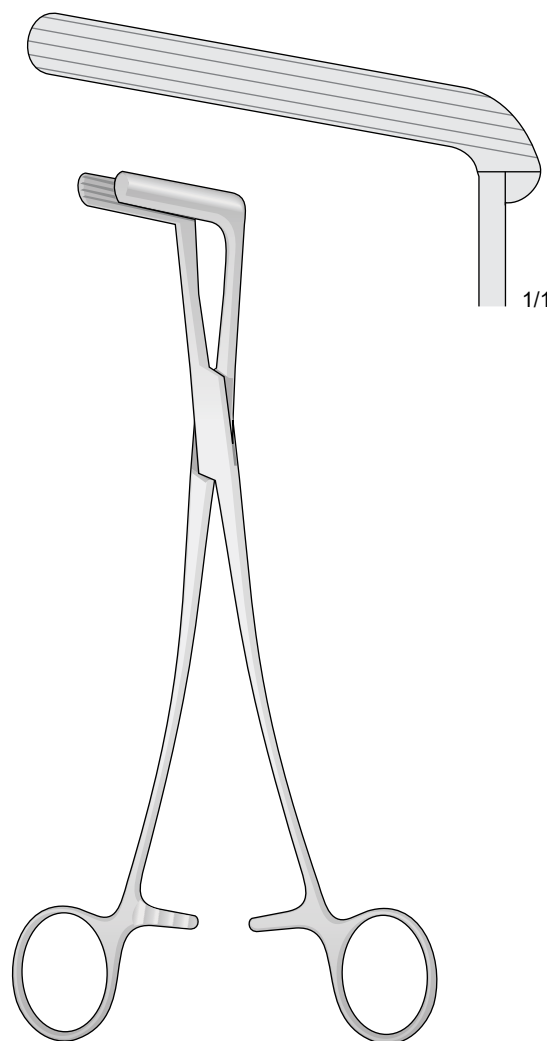

AVC 543-23 23.5 cm

WERTHEIM

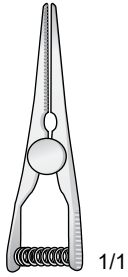

AVC 544-3 3.5 cm

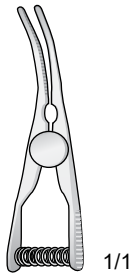

AVC 545-3 3.5 cm

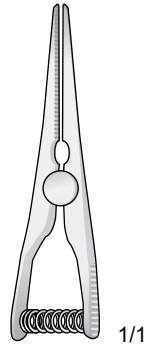

AVC 546-4 4.5 cm

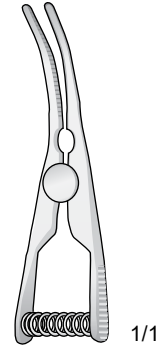

AVC 547-4 4.5 cm

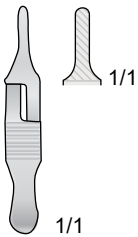

AVC 548-3 3 cm

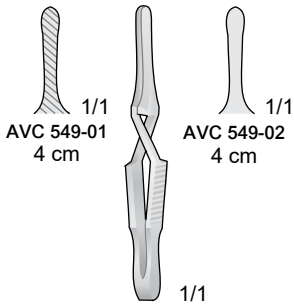

DIFFENBACH
AVC 549-01 / AVC 549-02 4 cm

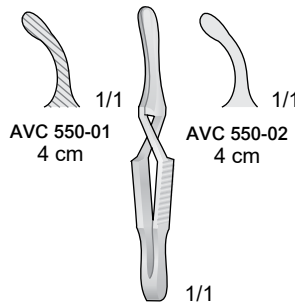

DIFFENBACH
AVC 550-01 / AVC 550-02 4 cm

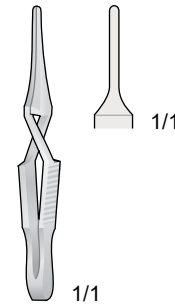

AVC 551-4 4 cm

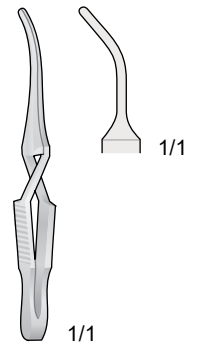

AVC 552-4 4.5 cm

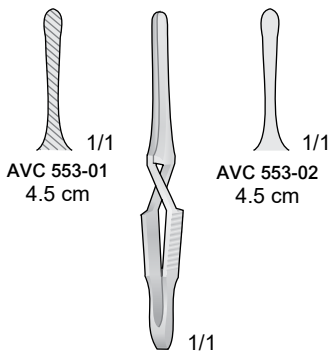

DIFFENBACH
AVC 553-01 / AVC 553-02 4.5 cm

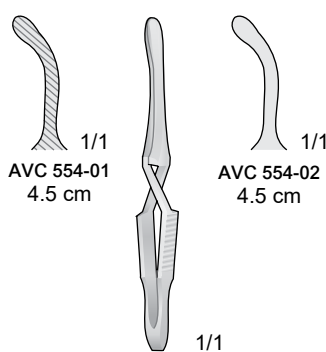

DIFFENBACH
AVC 554-01 / AVC 554-02 4.5 cm

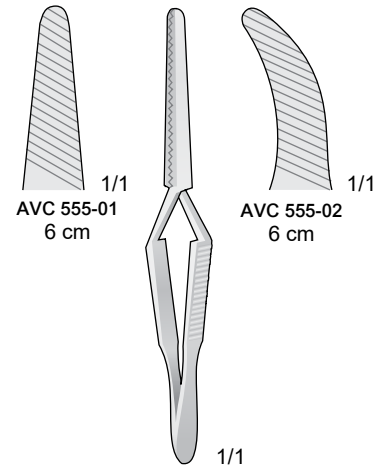

DIFFENBACH
AVC 555-01 / AVC 555-02 6 cm

Pinze Atrauma Bulldog
 Atrauma Bulldog clamps
 Atrauma Bulldogklemmen
 Clamps Bulldog Atrauma
 Pinzas Atrauma Bulldog

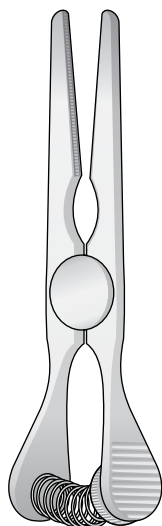

GLOVER

AVC 556-01 / AVC 556-04

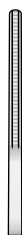

1/1

AVC 556-01
6 cm



1/1

AVC 556-02
7 cm



1/1

AVC 556-03
9 cm



1/1

AVC 556-04
11 cm

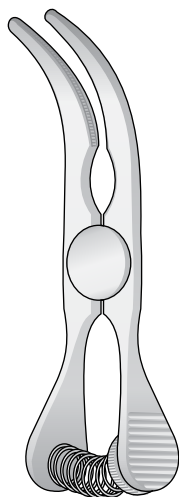

GLOVER

AVC 557-01 / AVC 557-04



1/1

AVC 557-02
6.5 cm

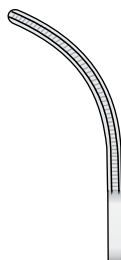

1/1

AVC 557-03
8.5 cm



1/1

AVC 557-04
10.5 cm

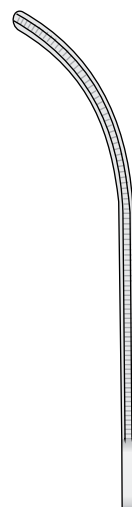

1/1

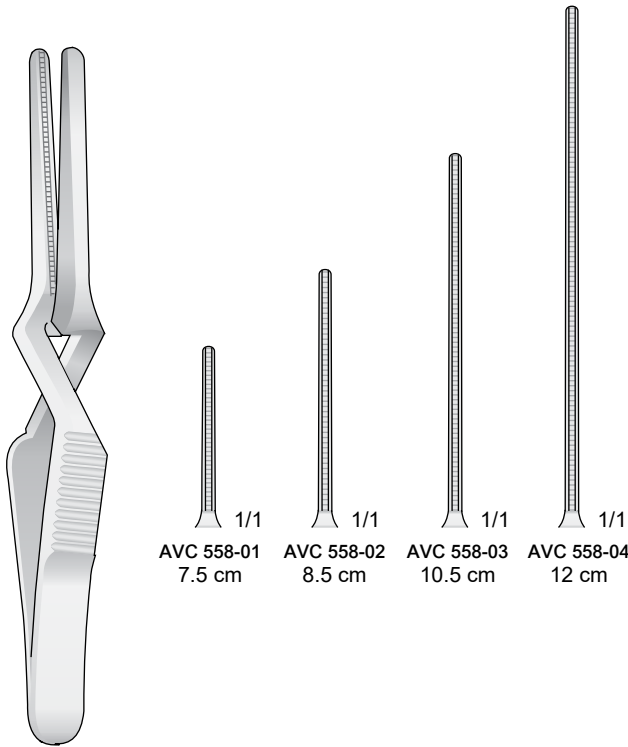

AVC 558-01 / AVC 558-04

Pinza per applicare e rimuovere Bulldog clamps
Zange zum ansetzen der Bulldogklemmen
Forceps for applying and removing Bulldog clamps
Pinces pour applicateur clamps Bulldog
Pinzas de aplicación para pinzas Bulldog

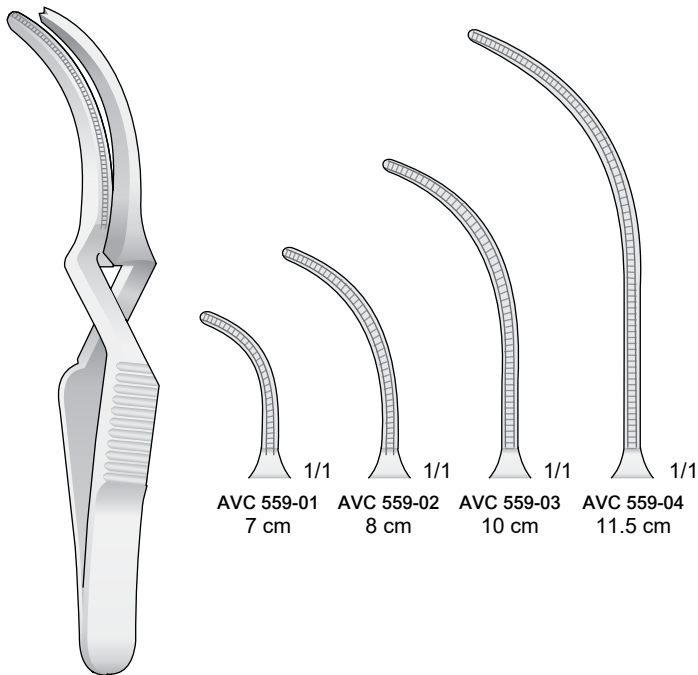

AVC 559-01 / AVC 559-04

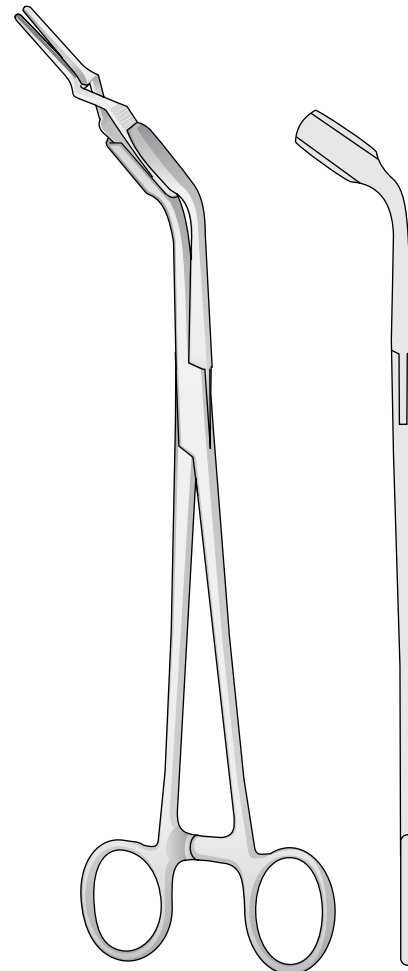

AVC 560-23 23 cm

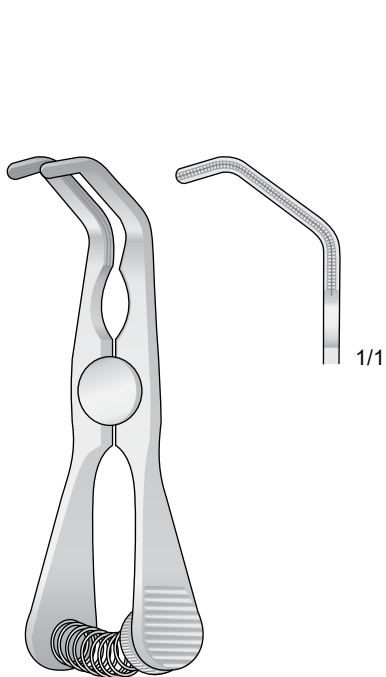

DE BAKEY-SATINSKY
AVC 561-7 7 cm

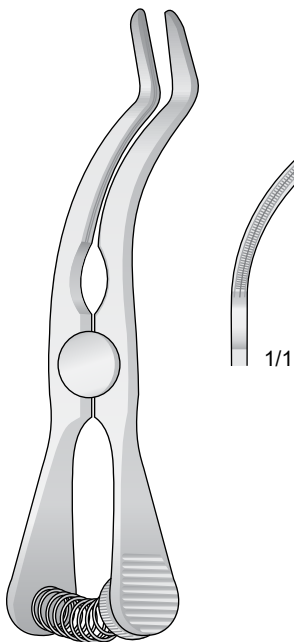

DE BAKEY-CAROTIS
AVC 562-9 9 cm

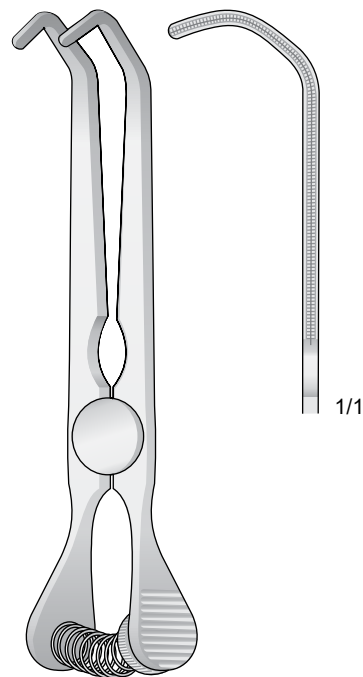

DE BAKEY-SATINSKY
AVC 563-10 10 cm

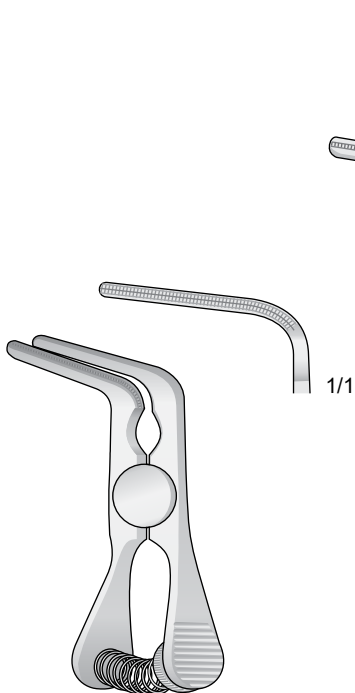

GLOVER
AVC 564-5 5 cm

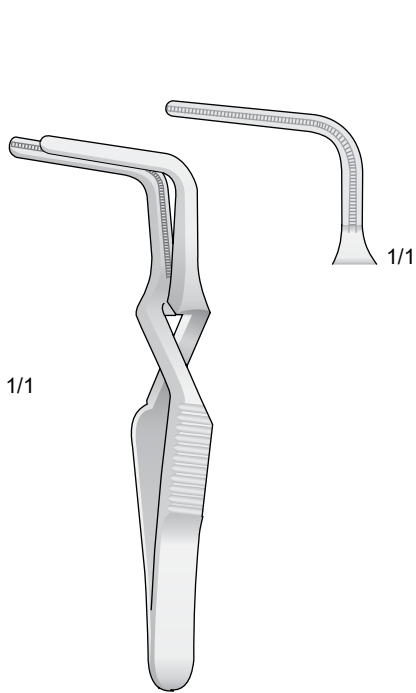

SANTULLI
AVC 565-7 7 cm

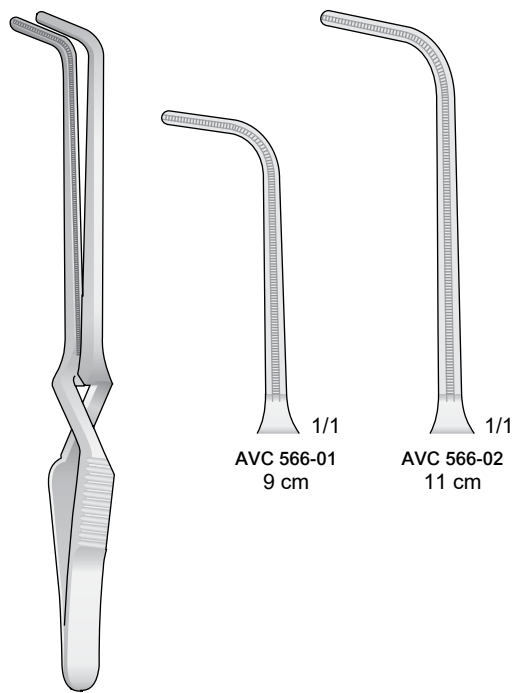

AVC 566-01 / AVC 566-02

Pinze atraumatiche per neonati e bambini
 Atraumatic Vessel clamps for babies and children
 Atraumatische Gefäßklemmen für Säuglinge und Kinder
 Pincas vasculares atraumáticas pour enfants
 Pinzas vasculares atraumáticas para niños

Modelli estremamente fini
 Delicate - Fein - Fins - Finas

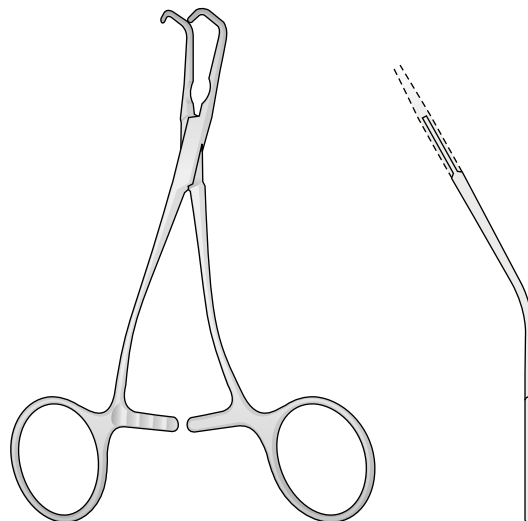
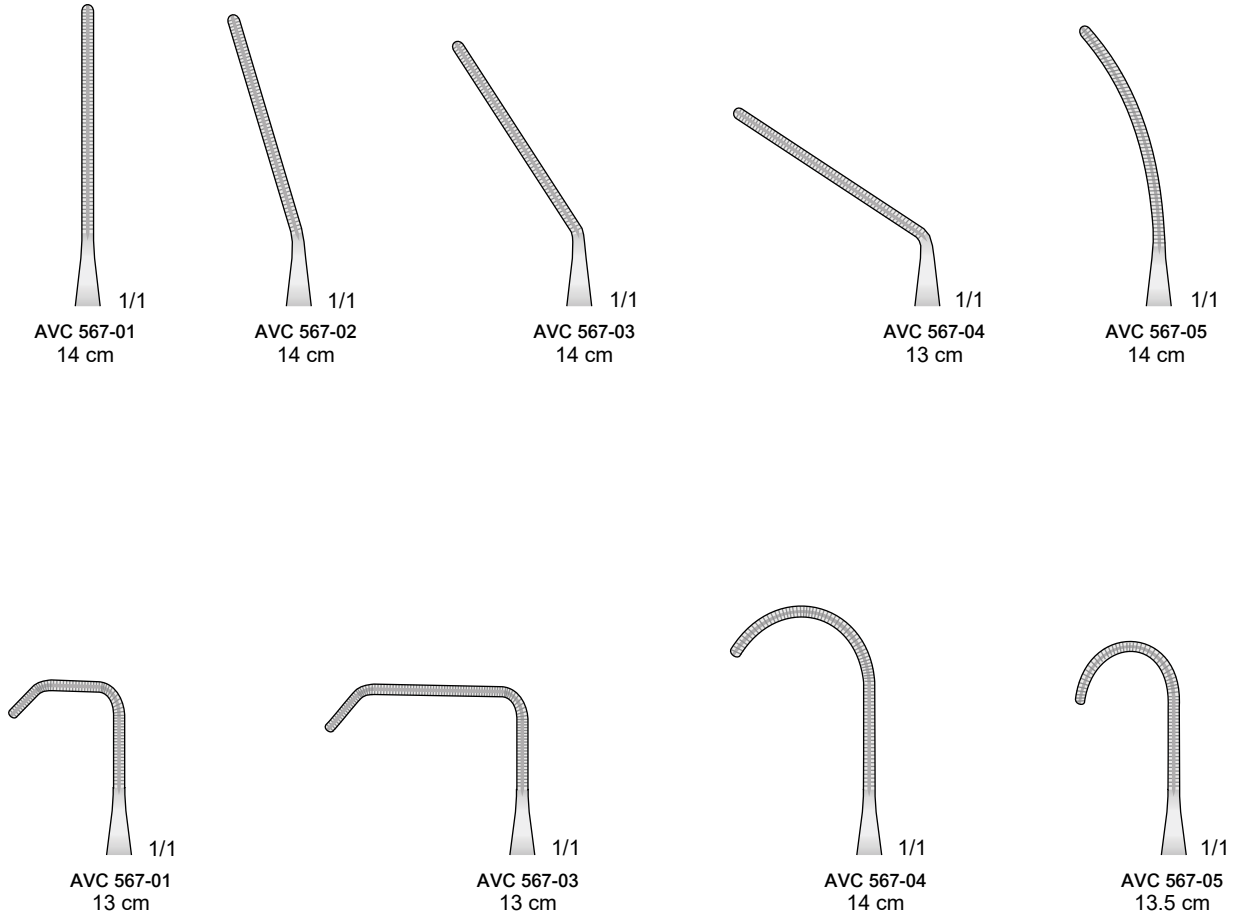

AVC 567-01 / AVC 567-09

Pinze atraumatiche
 Atraumatic vessel clamps
 Atraumatische Gefäßklemmen
 Pincés vasculaires atrauma
 Pinzas vasculares atraumáticas

Atraumatic
 Atraumatic
 Atraumatische
 Atraumatiques
 Atraumaticas

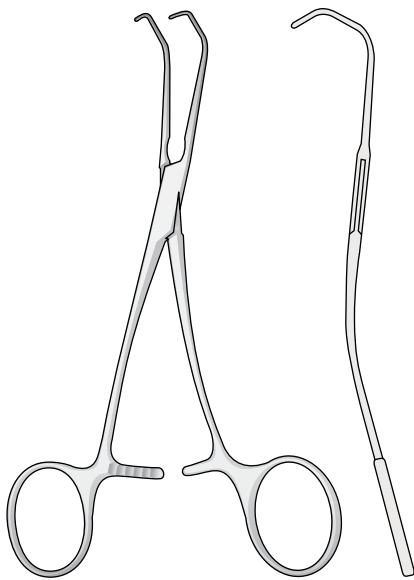

CASTANEDA

AVC 568-01 / AVC 568-04

15.5 cm

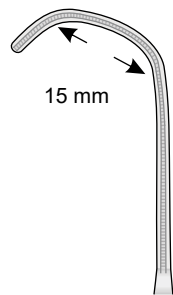

15 mm

AVC 568-01
4.8 cm

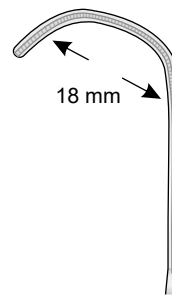

18 mm

AVC 568-02
5.2 cm

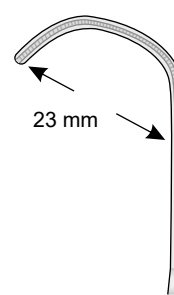

23 mm

AVC 568-03
5.6 cm

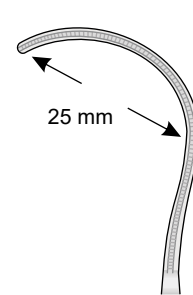

25 mm

AVC 568-04
5 cm

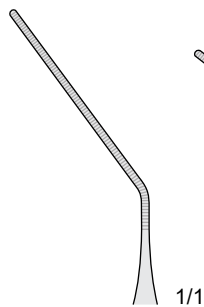

1/1

AVC 569-01
12 cm

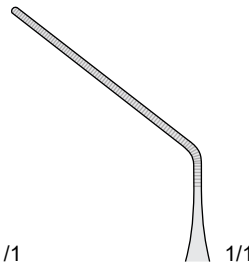

1/1

AVC 569-02
12 cm

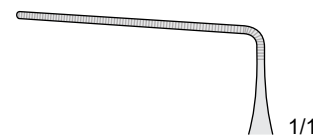

1/1

AVC 569-03
12 cm

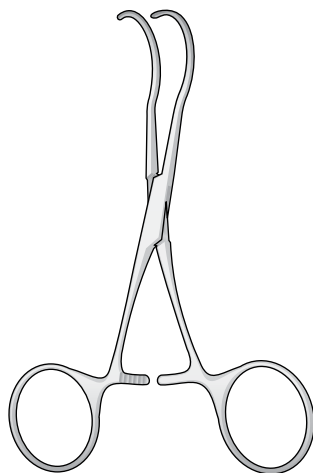

CASTANEDA

AVC 569-01 / AVC 569-07

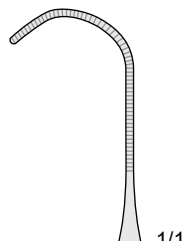

1/1

AVC 569-04
12 cm

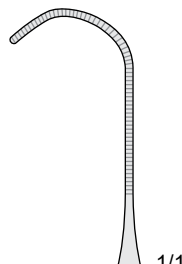

1/1

AVC 569-05
12 cm

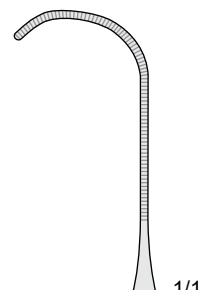

1/1

AVC 569-06
12 cm

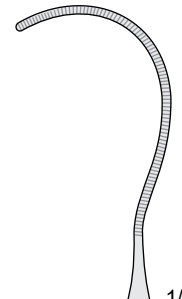

1/1

AVC 569-07
12 cm

Pinze per neonati e bambini
Atraumatic vessel clamps for babys and children
Säugling - und Kinderklemmen
Pinces-clamps pour nouveaux-nés et enfants
Pinzas vasculares atraumáticas para niños

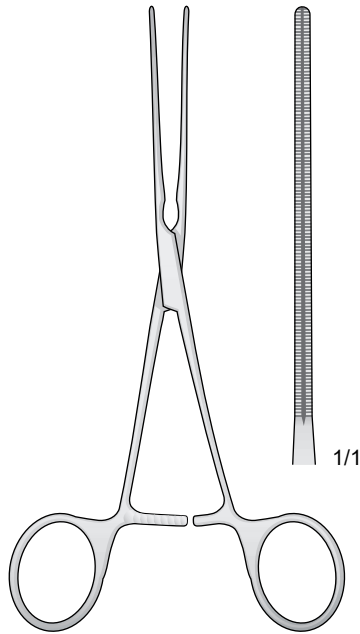

AVC 570-16 16.5 cm

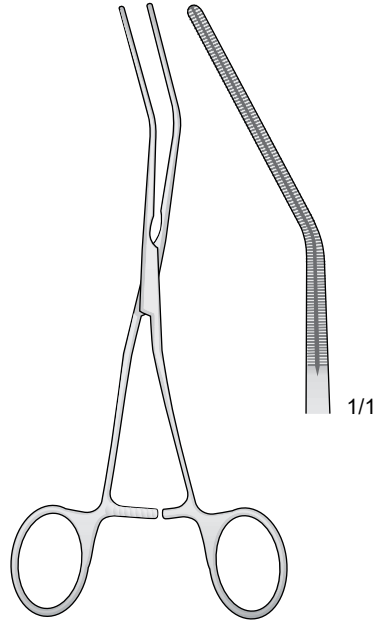

AVC 571-16 16 cm

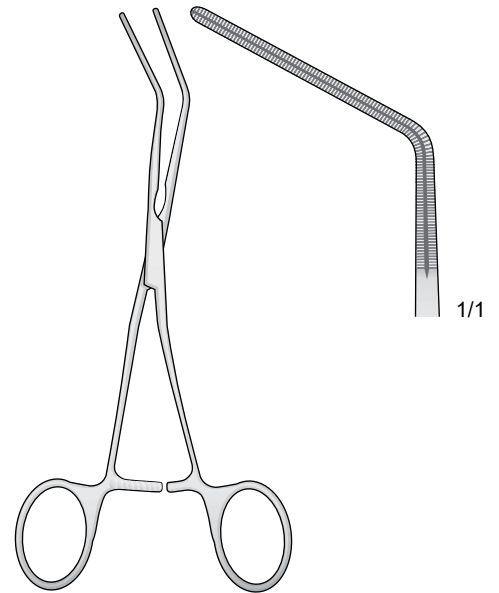

AVC 572-15 15 cm

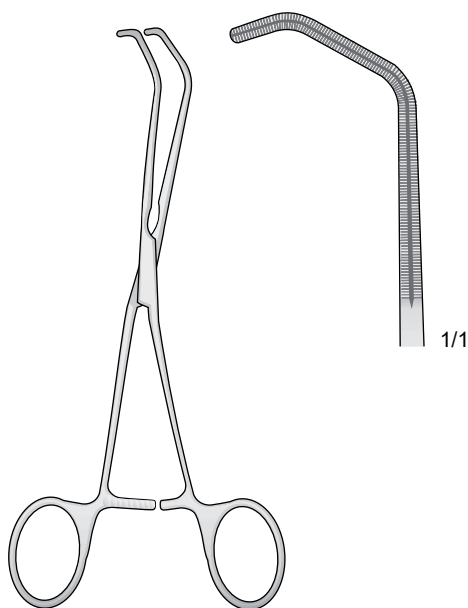

AVC 573-15 15 cm

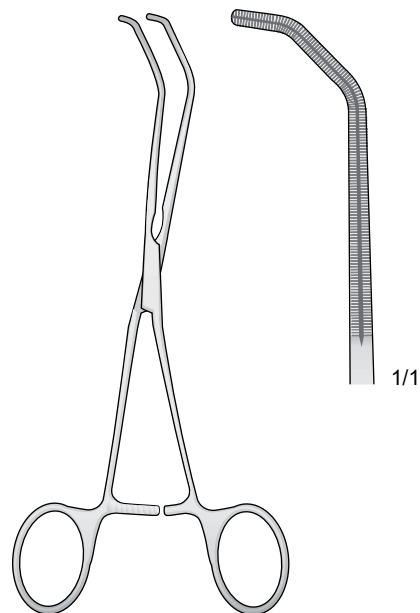

AVC 574-15 15.5 cm

Pinze atraumatiche
 Atraumatic vessel clamps
 Atraumatische Gefäßklemmen
 Pincés vasculaires atrauma
 Pinzas vasculares atraumáticas

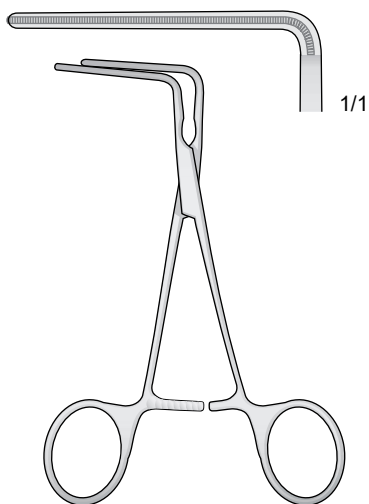

De BAKEY
AVC 575-10 10 cm

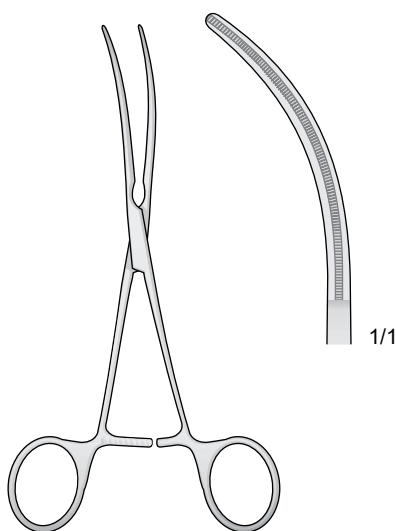

De BAKEY
AVC 576-11 11cm

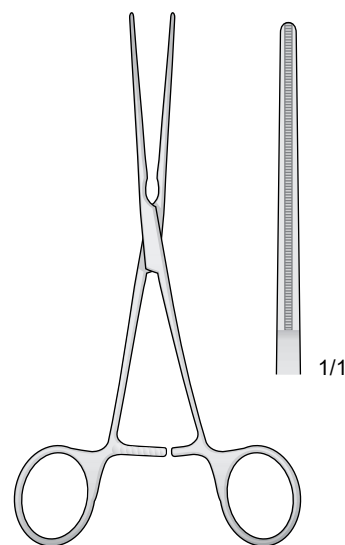

De BAKEY
AVC 577-12 12 cm

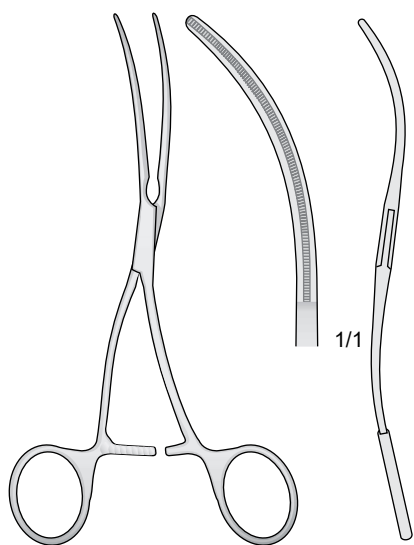

De BAKEY
AVC 578-12 12 cm

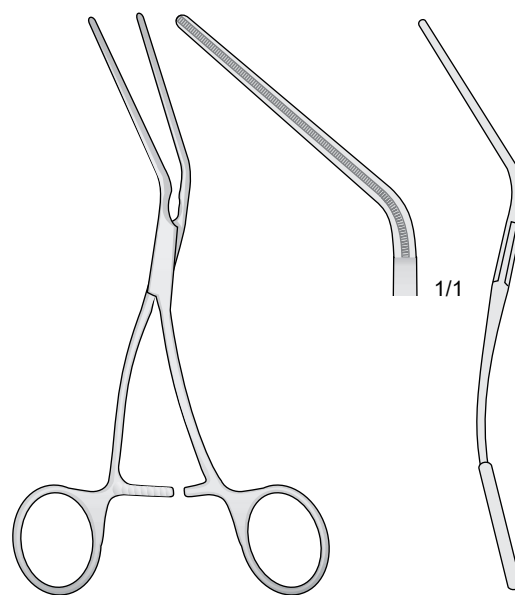

De BAKEY
AVC 579-13 13 cm

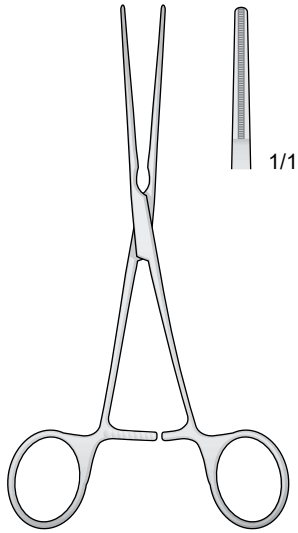

De BAKEY - MOSQUITO
AVC 580-12 12 cm

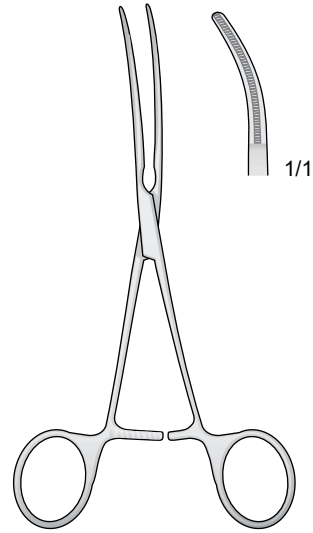

De BAKEY - MOSQUITO
AVC 581-12 12 cm

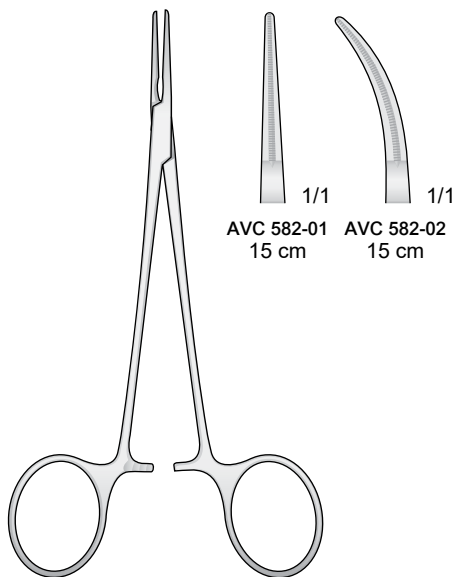

De BAKEY - MOSQUITO
AVC 582-01 / AVC 582-02

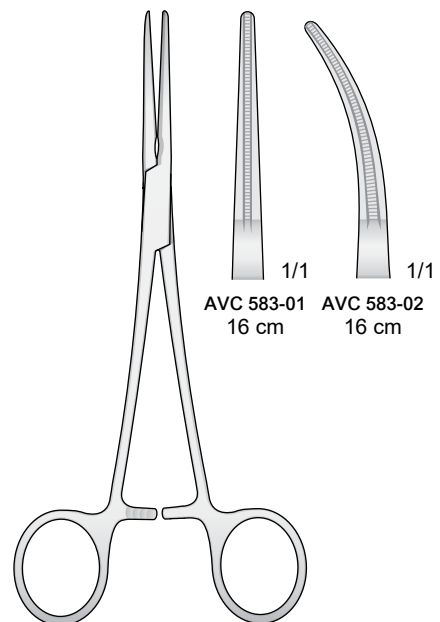

De BAKEY - RANKIN
AVC 583-01 / AVC 583-02

Pinze atraumatiche
Atraumatic vessel clamps
Atraumatische Gefäßklemmen
Pincés vasculaires atrauma
Pinzas vasculares atraumáticas

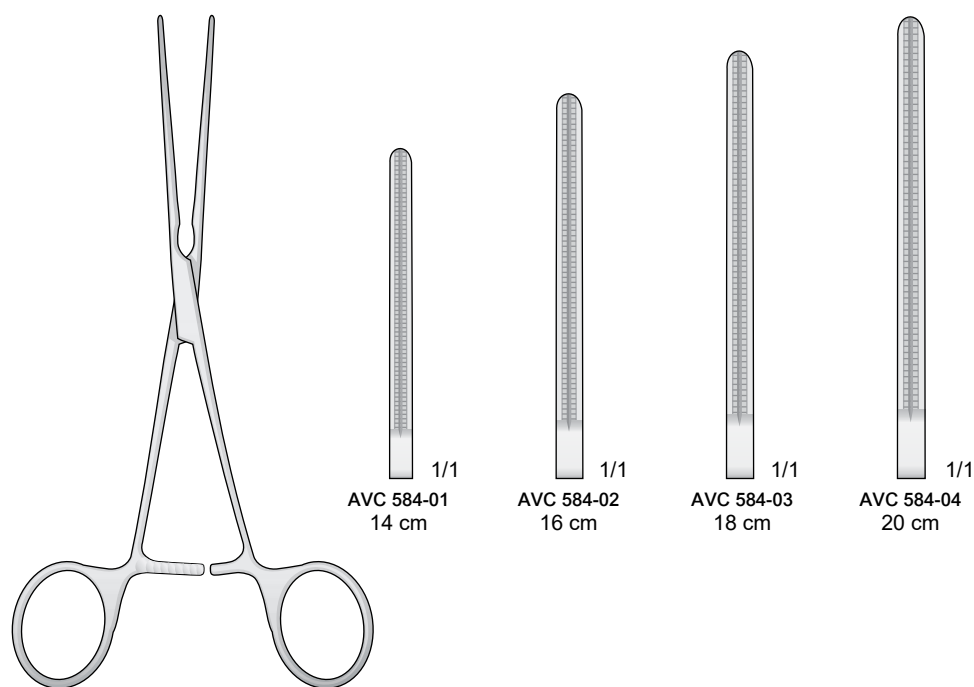

De BAKEY - PEAN

AVC 584-01 / AVC 584-04

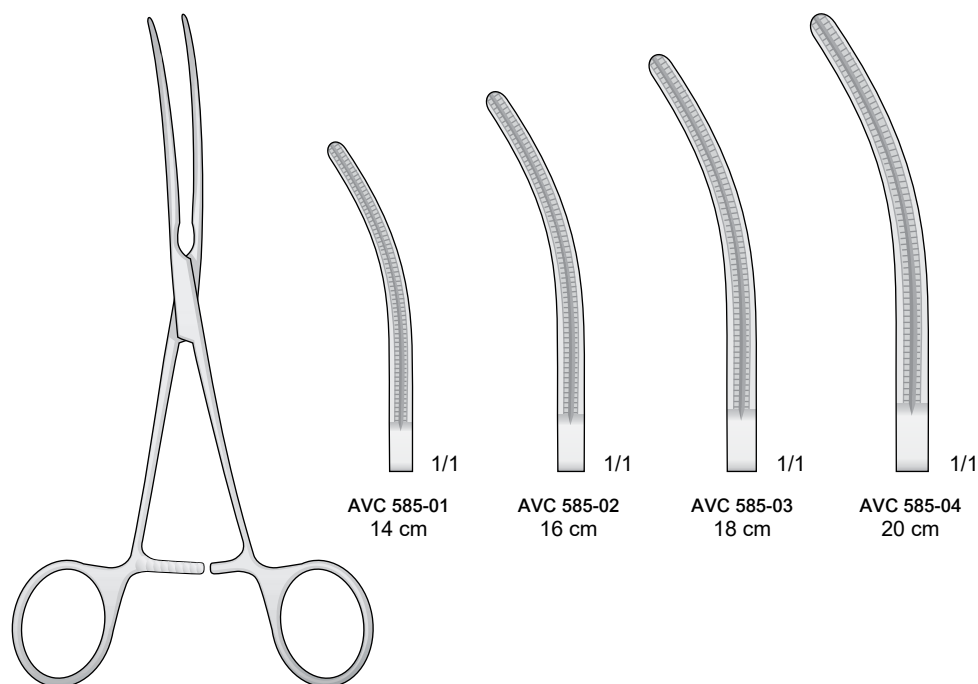

De BAKEY - PEAN

AVC 585-01 / AVC 585-04

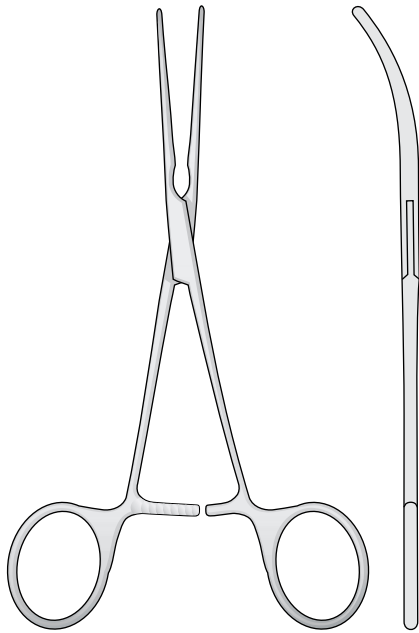

De BAKEY
AVC 586-01 / AVC 586-02

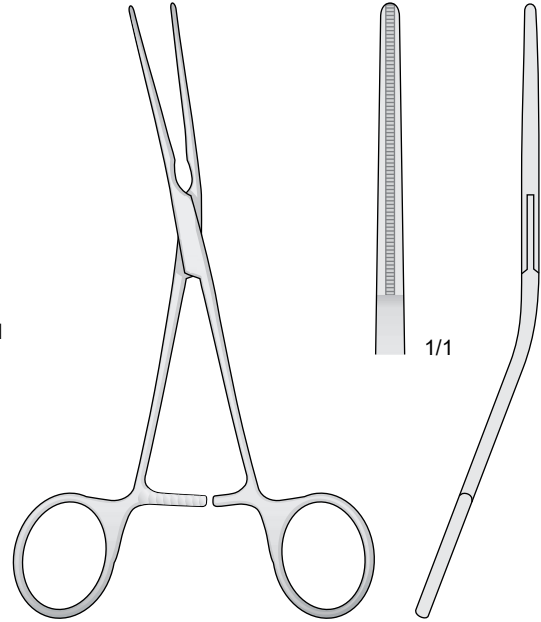
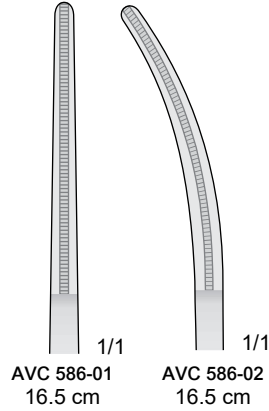

De BAKEY
AVC 587-16 16.5 cm

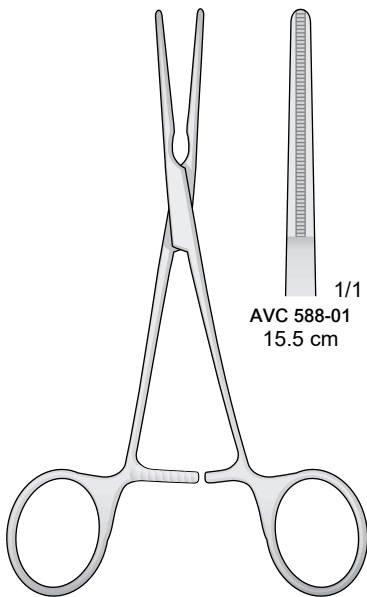
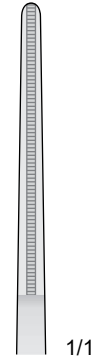

De BAKEY - BAINBRIDGE
AVC 588-01 / AVC 588-02

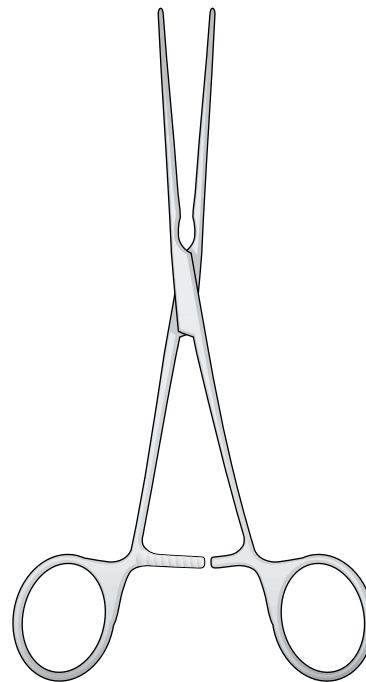
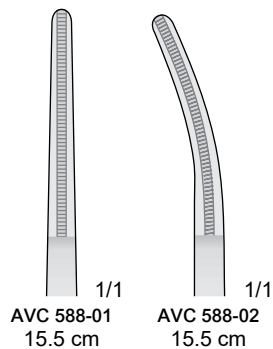

De BAKEY - BAINBRIDGE
AVC 589-01 / AVC 589-02

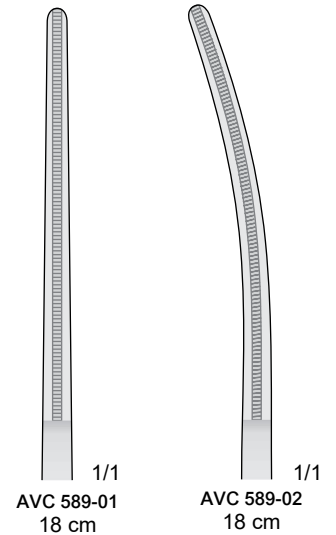

Pinze atraumatiche
Atraumatic vessel clamps
Atraumatische Gefäßklemmen
Pincés vasculaires atrauma
Pinzas vasculares atraumáticas

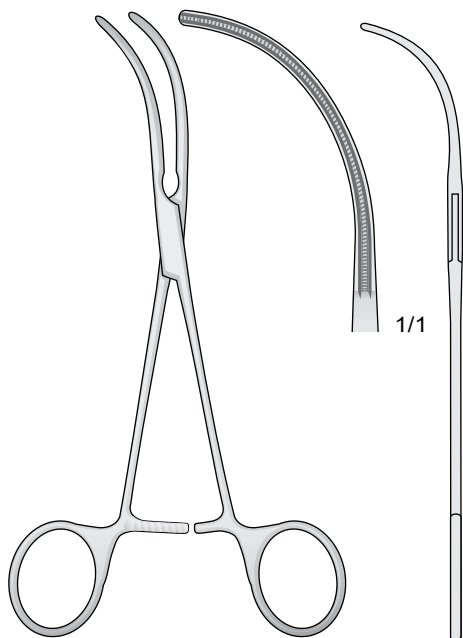

De BAKEY

AVC 590-16 16 cm

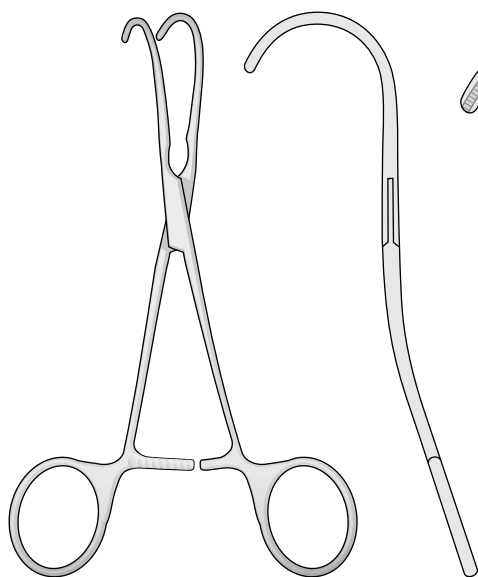

De BAKEY

AVC 591-01 / AVC 591-02

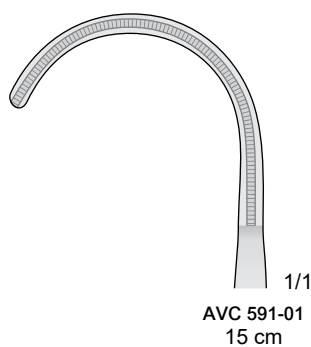

AVC 591-01
15 cm

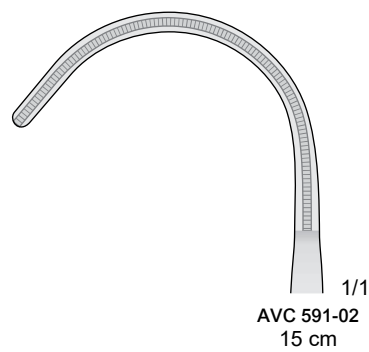

AVC 591-02
15 cm

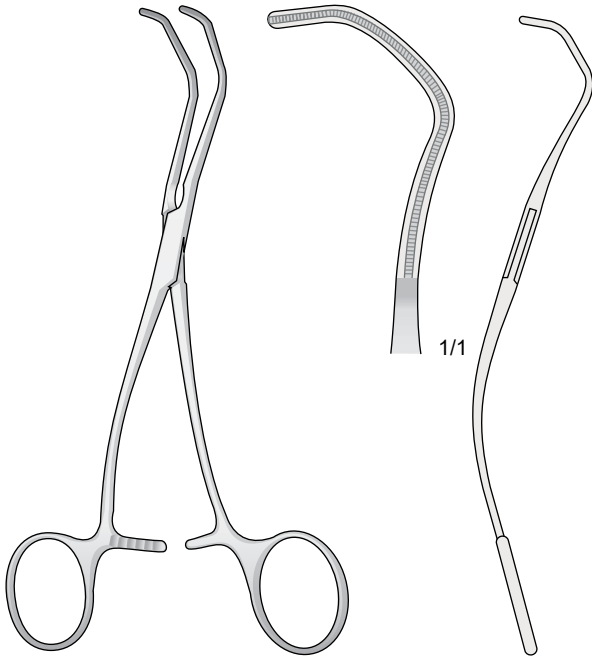

De-BAKEY
AVC 592-17 17 cm

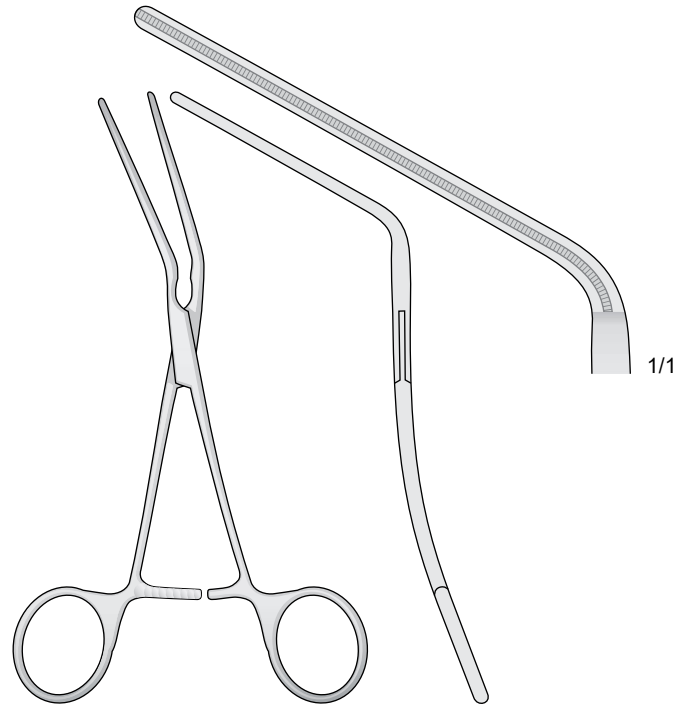

De BAKEY
AVC 593-16 16.5 cm

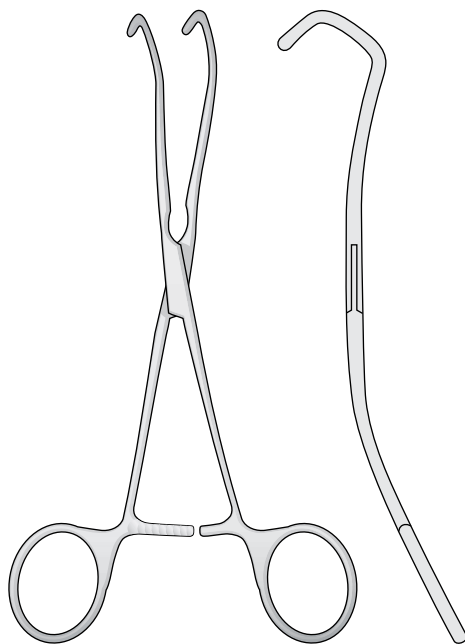

DERRA
AVC 594-01 / AVC 594-03

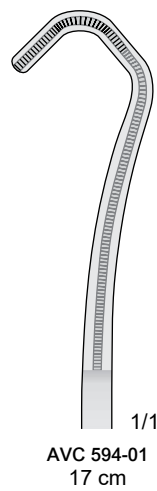

AVC 594-01
17 cm

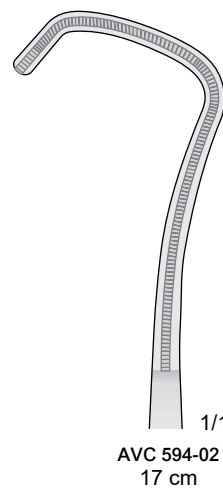

AVC 594-02
17 cm

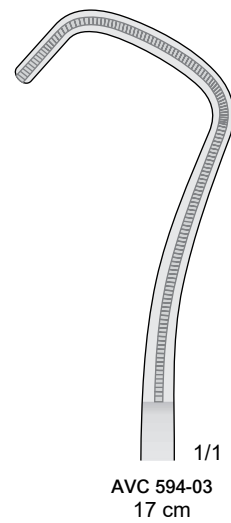

AVC 594-03
17 cm

Pinze atraumatiche
 Atraumatic vessel clamps
 Atraumatische Gefäßklemmen
 Pincés vasculaires atrauma
 Pinzas vasculares atraumáticas

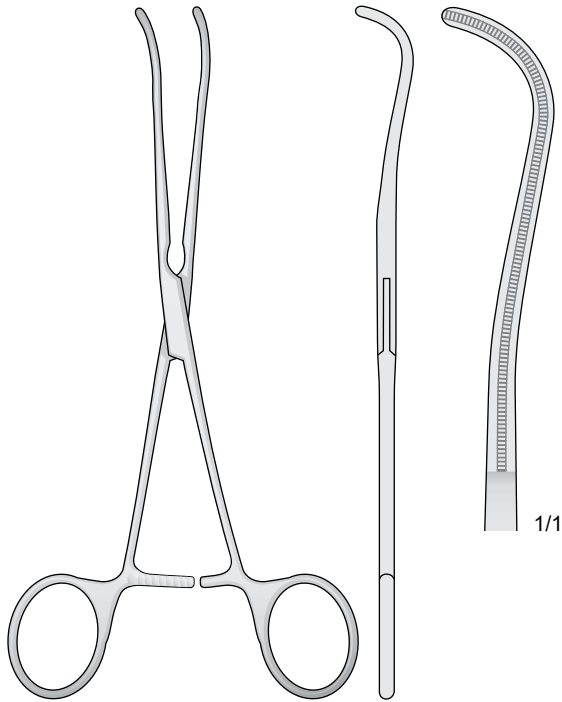

De BAKEY
AVC 595-19 19 cm

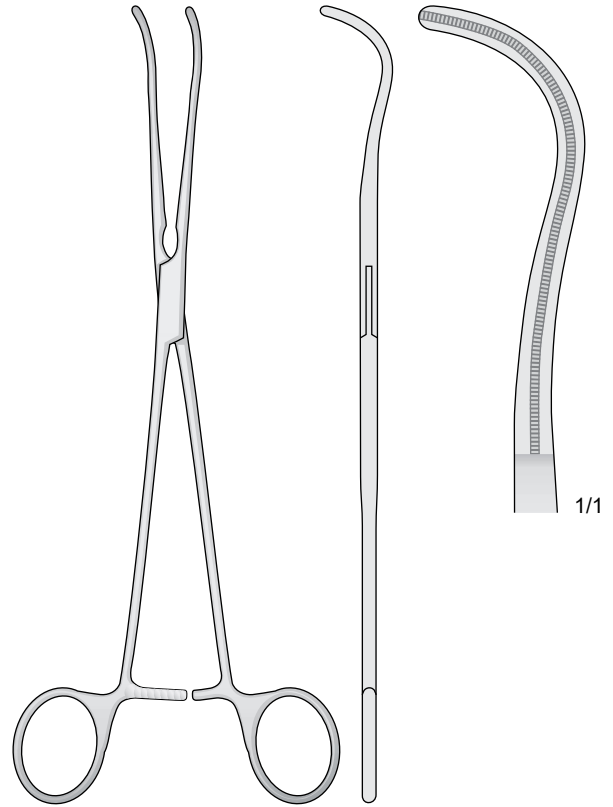

De BAKEY
AVC 596-23 23 cm

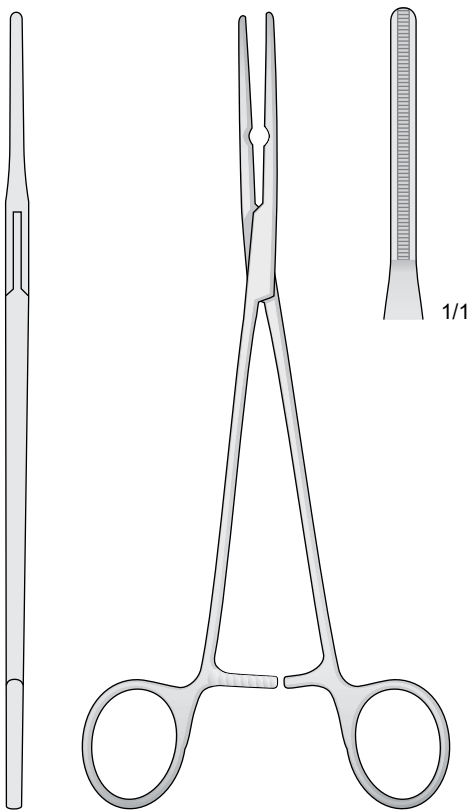

De BAKEY
AVC 597-21 21.5 cm

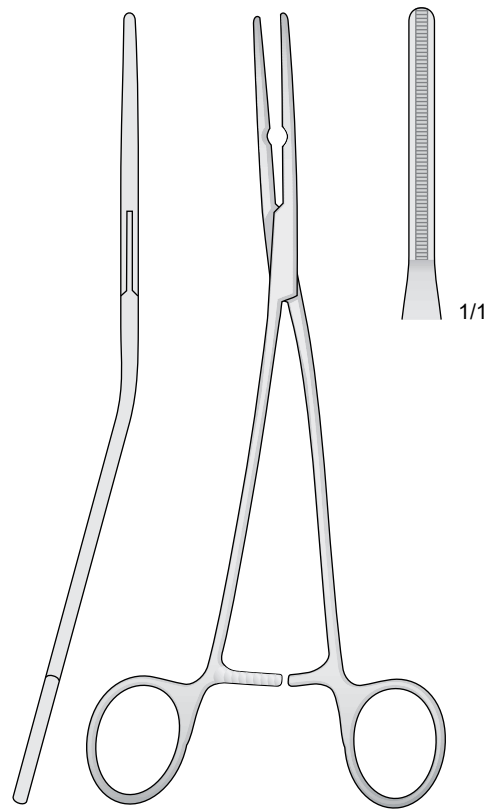

De BAKEY
AVC 598-21 21.5 cm

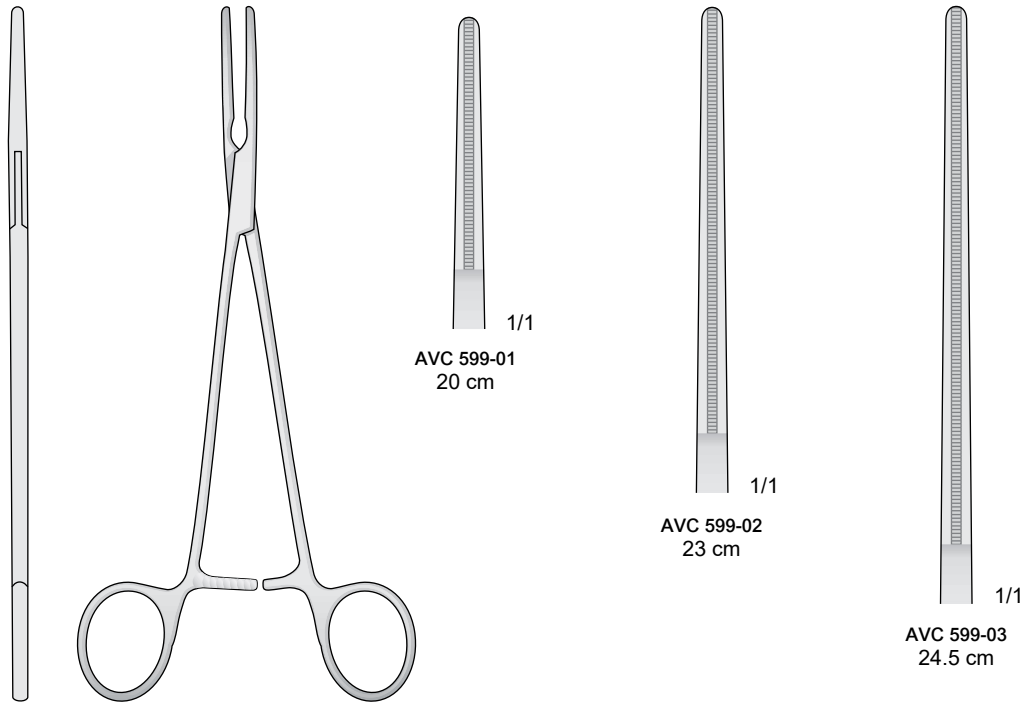

De BAKEY

AVC 599-01 / AVC 599-03

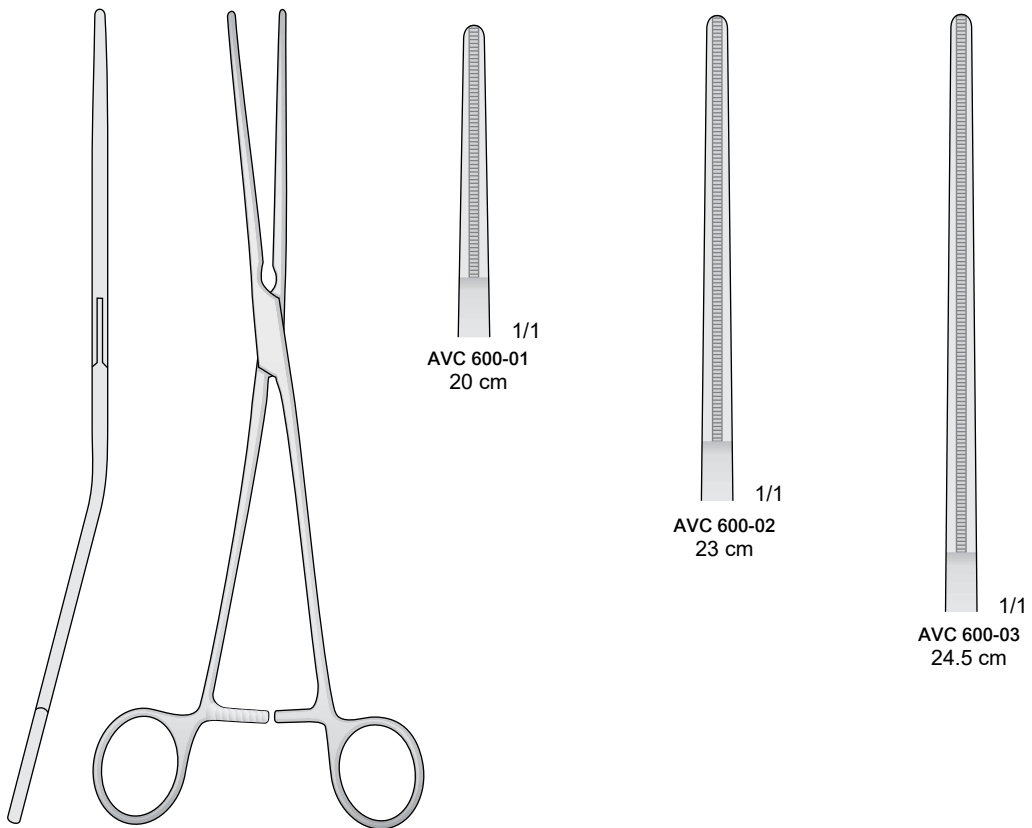

De BAKEY

AVC 600-01 / AVC 600-03

Pinze atraumatiche
 Atraumatic vessel clamps
 Atraumatische Gefäßklemmen
 Pinces vasculaires atrauma
 Pinzas vasculares atraumáticas

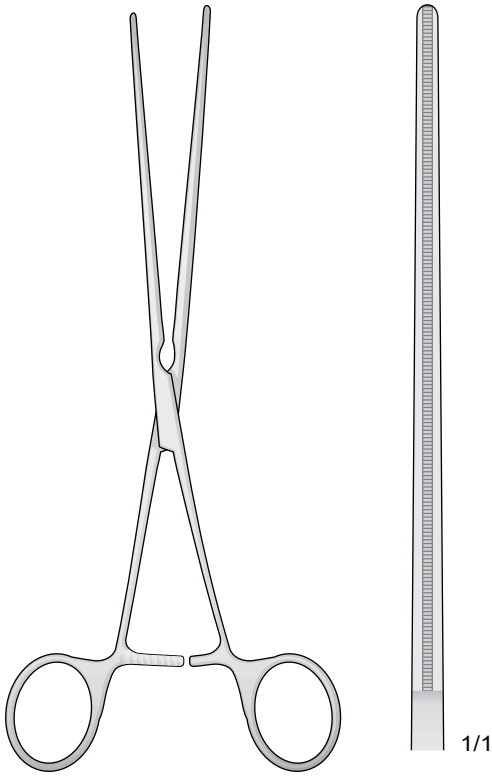

De BAKEY
AVC 601-22 22 cm

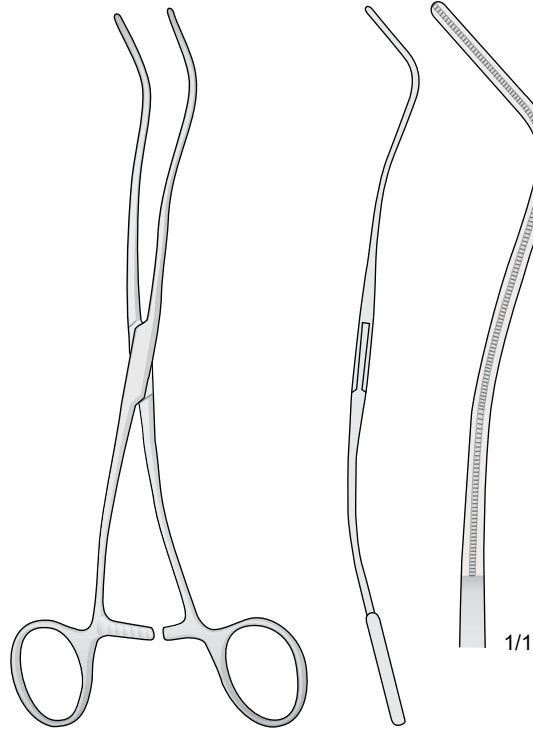

De BAKEY
AVC 602-20 20 cm

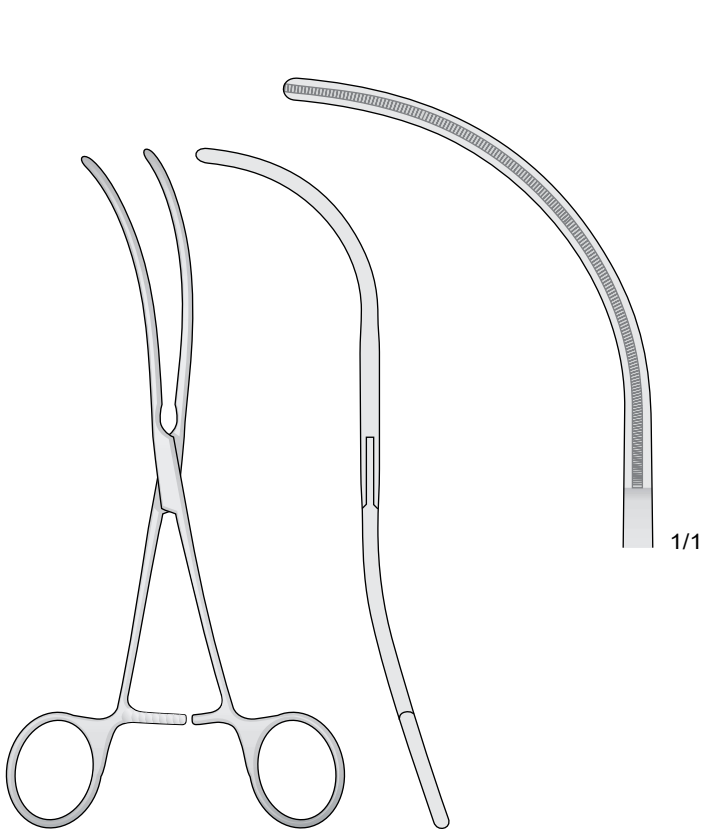

De BAKEY
AVC 603-18 18 cm

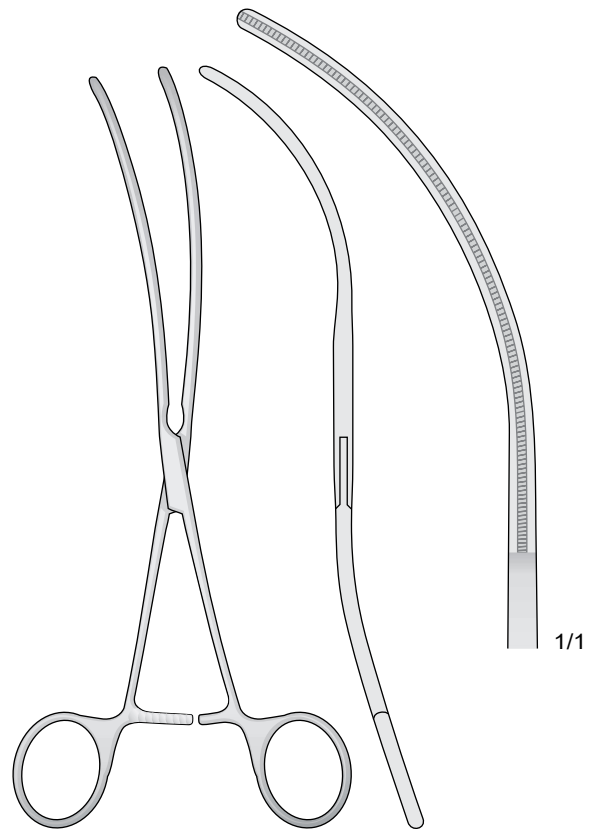

De BAKEY
AVC 604-20 20 cm

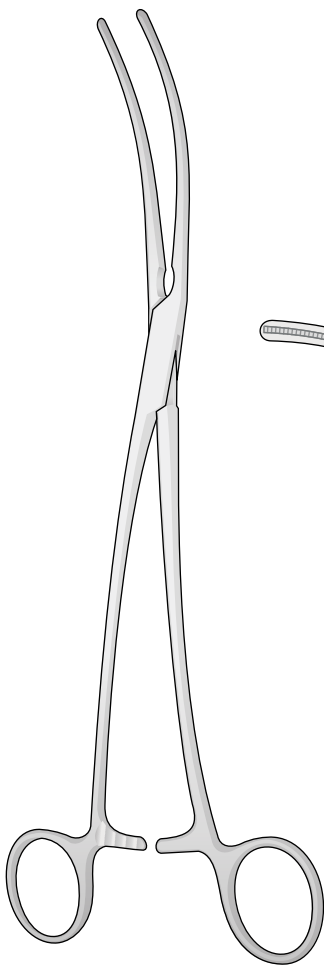

De BAKEY-BAHNSON
AVC 605-01 / AVC 605-03

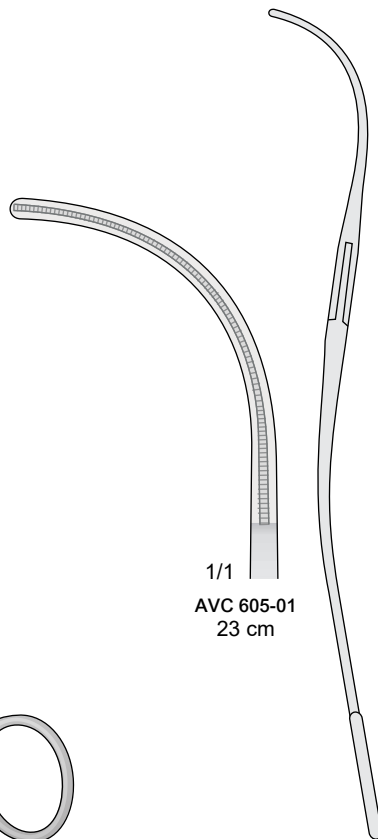

1/1
AVC 605-01
23 cm

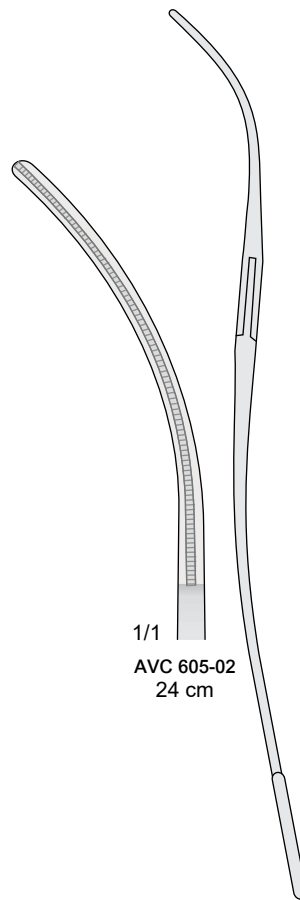

1/1
AVC 605-02
24 cm

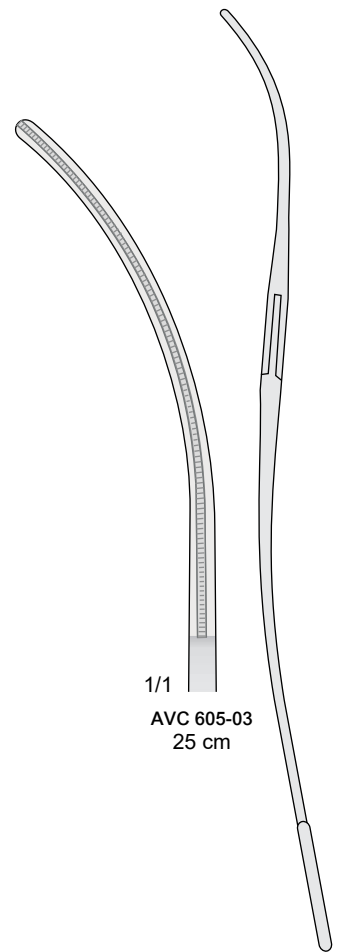

1/1
AVC 605-03
25 cm

Pinze atraumatiche
Atraumatic vessel clamps
Atraumatische Gefäßklemmen
Pincés vasculaires atrauma
Pinzas vasculares atraumáticas

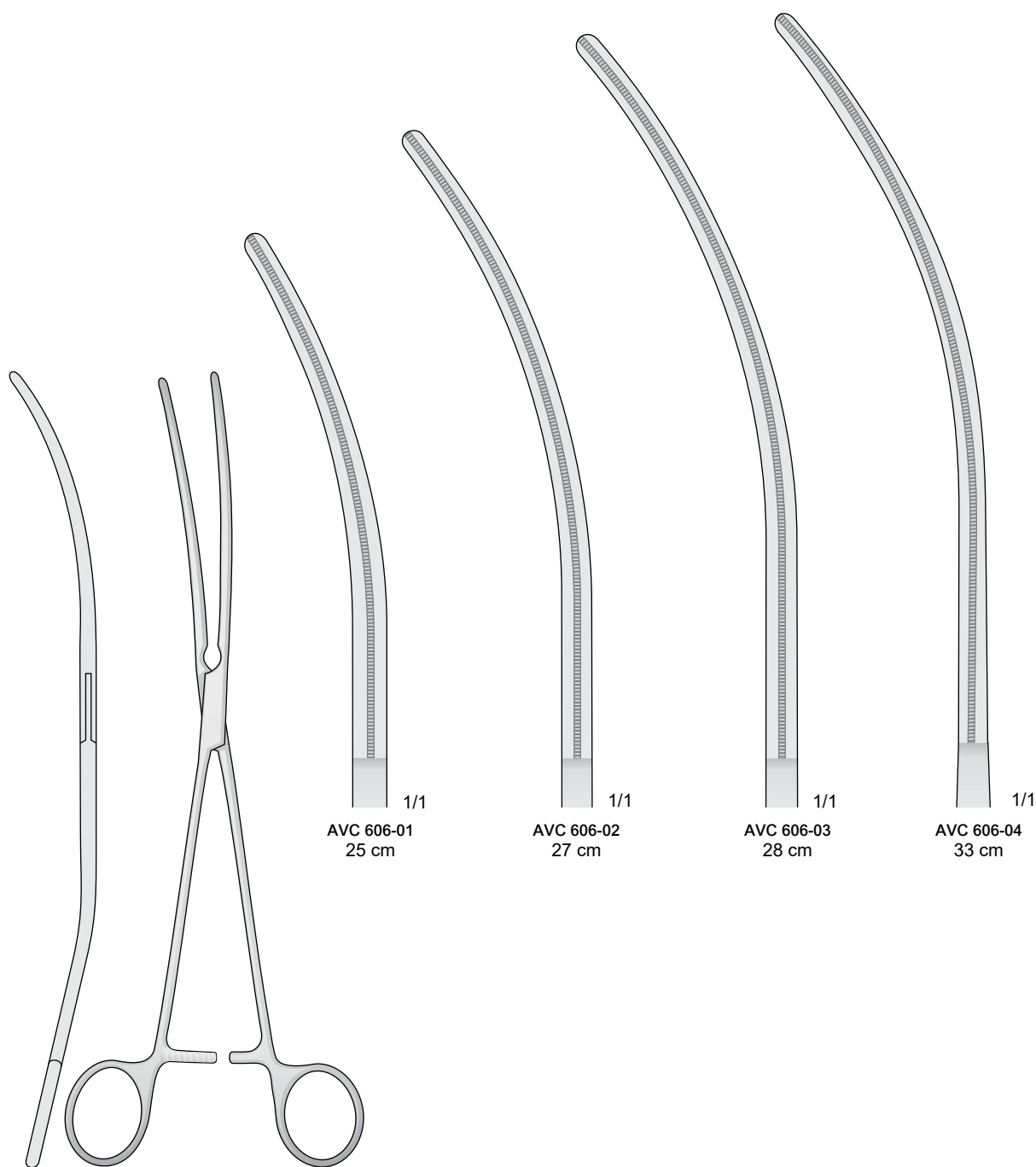

De BAKEY

AVC 606-01 / AVC 606-04



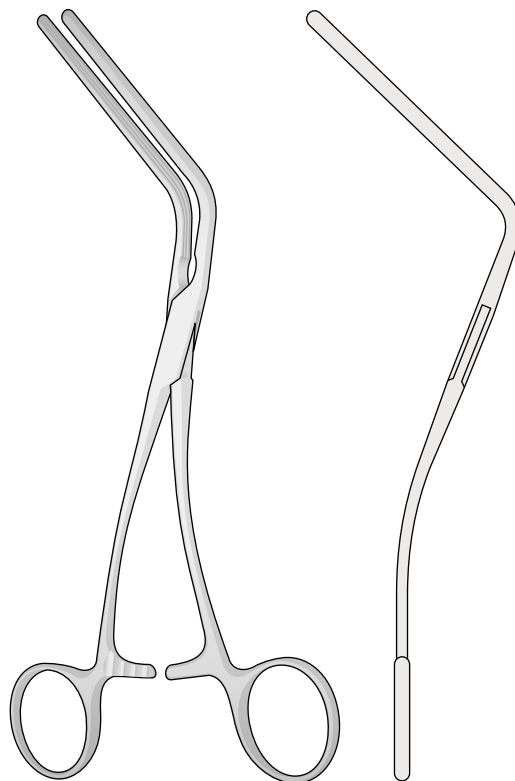
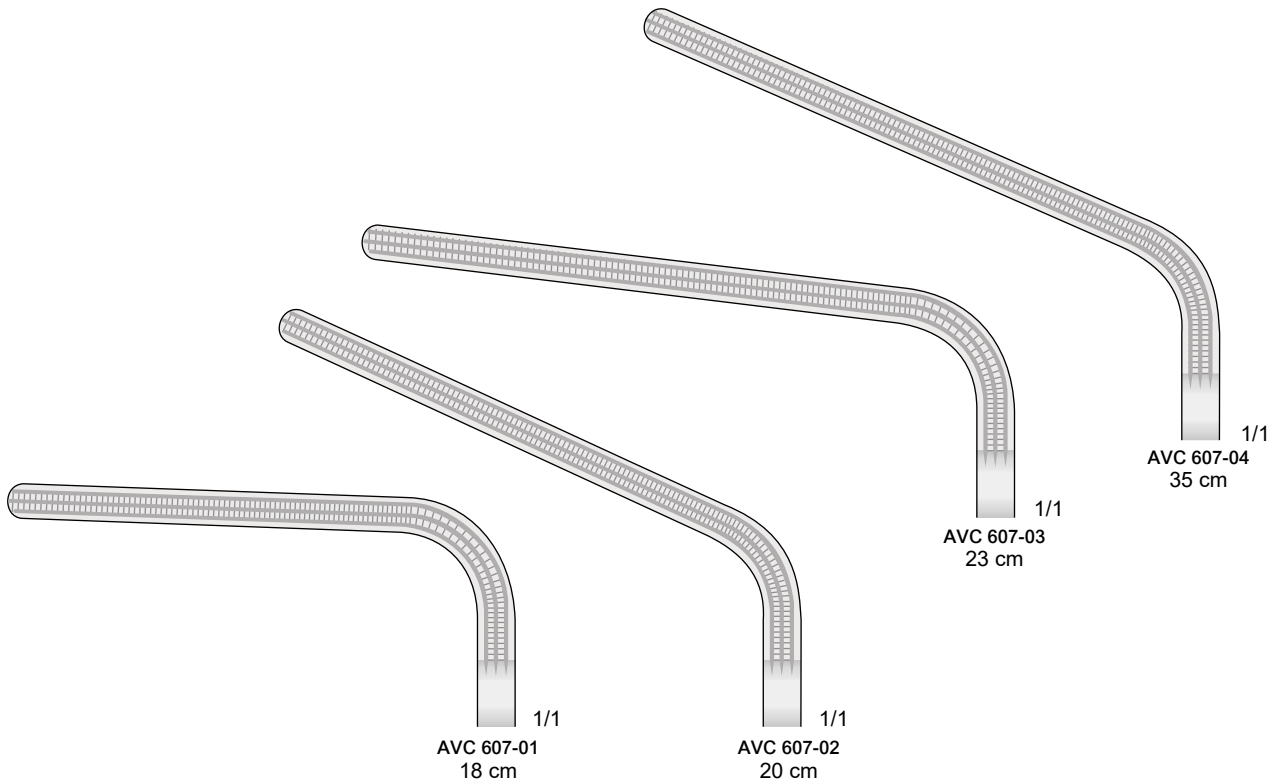

MORRIS-De BAKEY
AVC 607-01 / AVC 607-04

Pinze atraumatiche
 Atraumatic vessel clamps
 Atraumatische Gefäßklemmen
 Pincés vasculaires atrauma
 Pinzas vasculares atraumáticas

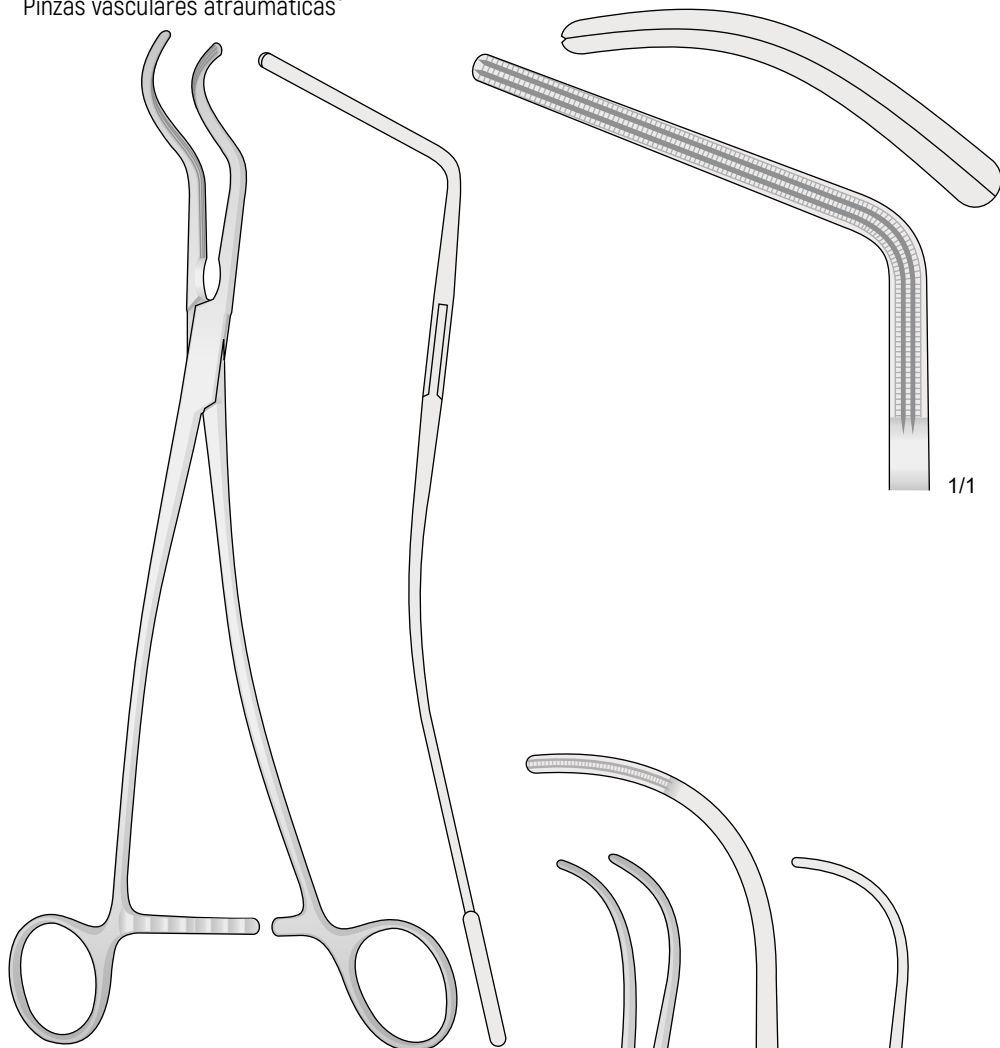

De BAKEY
AVC 608-27 27 cm

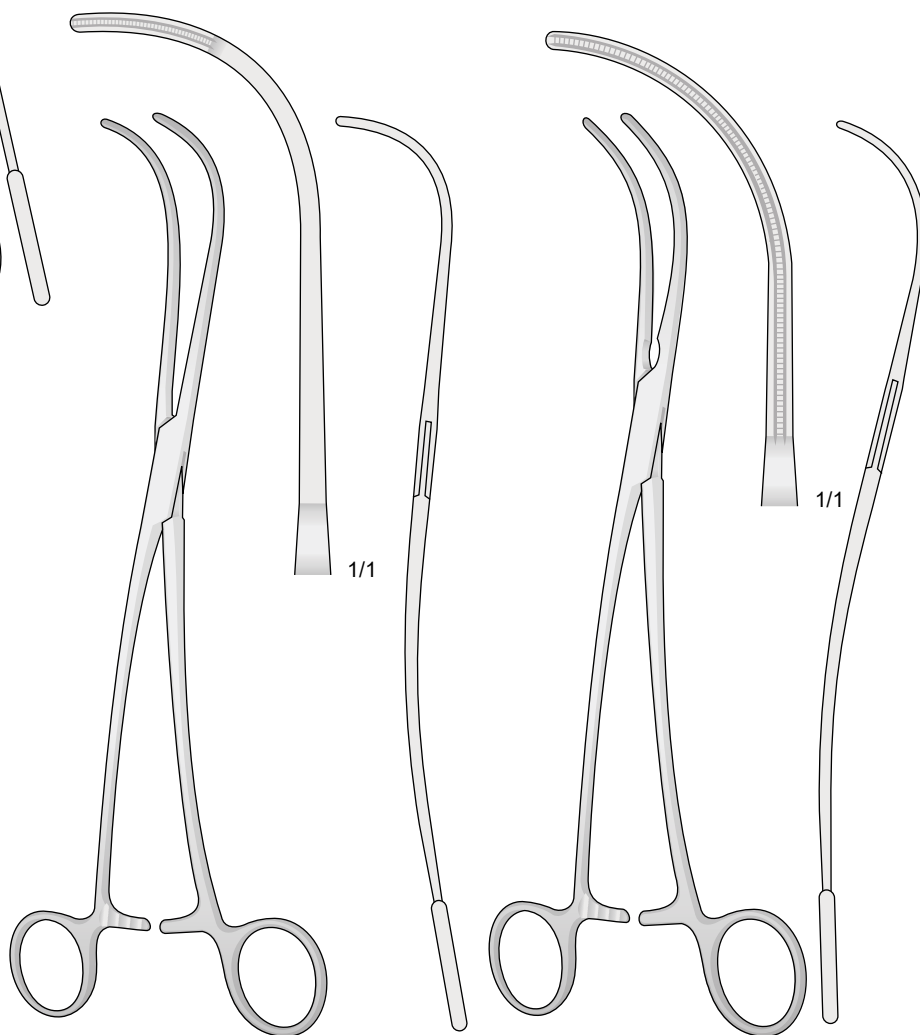

De BAKEY
AVC 609-24 24 cm

De BAKEY
AVC 610-24 24 cm

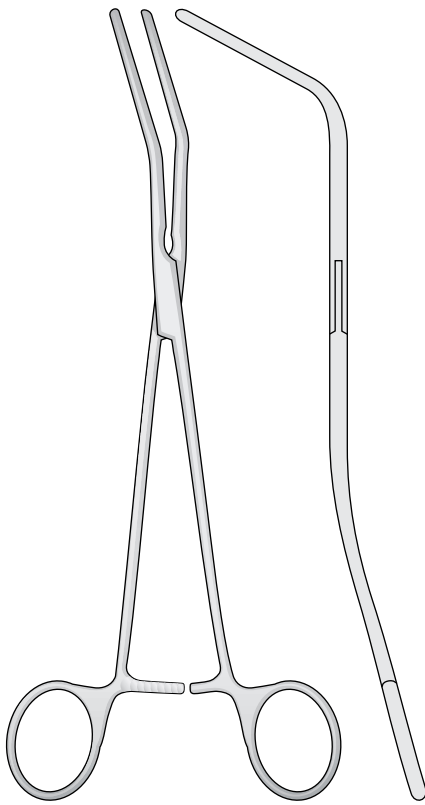

De BAKEY

AVC 611-01 / AVC 611-04

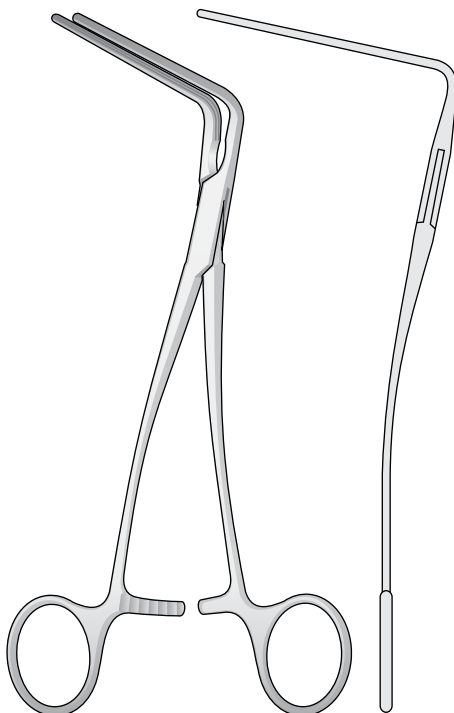
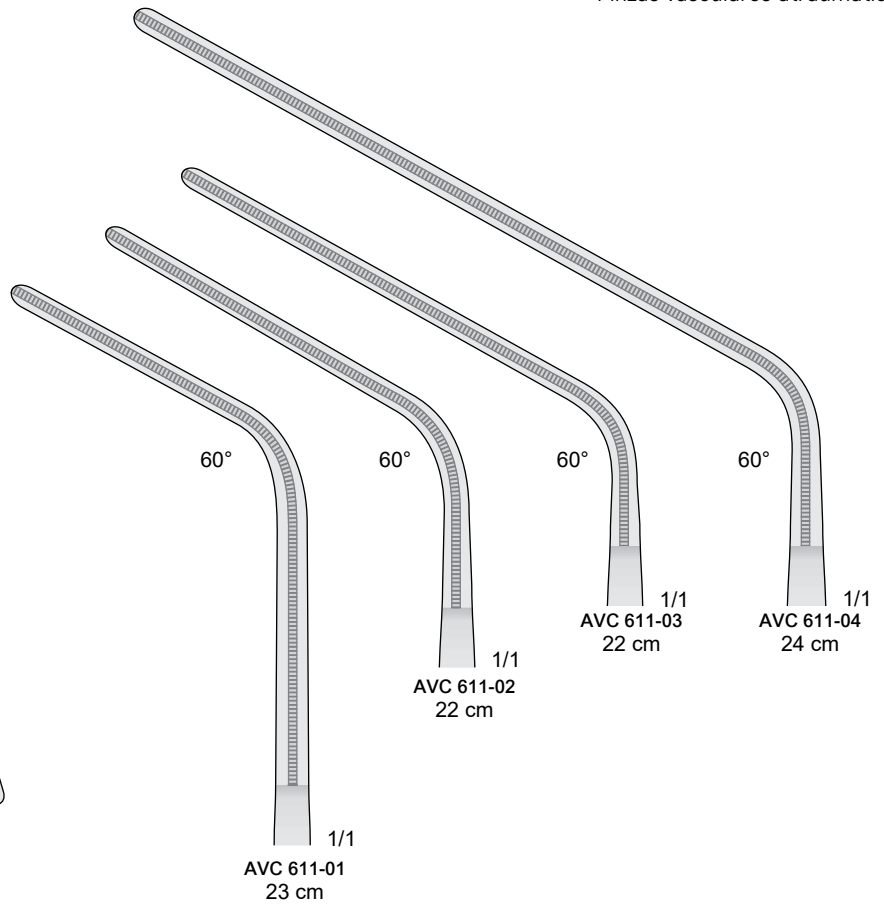

De-BAKEY

AVC 612-01 / AVC 612-04

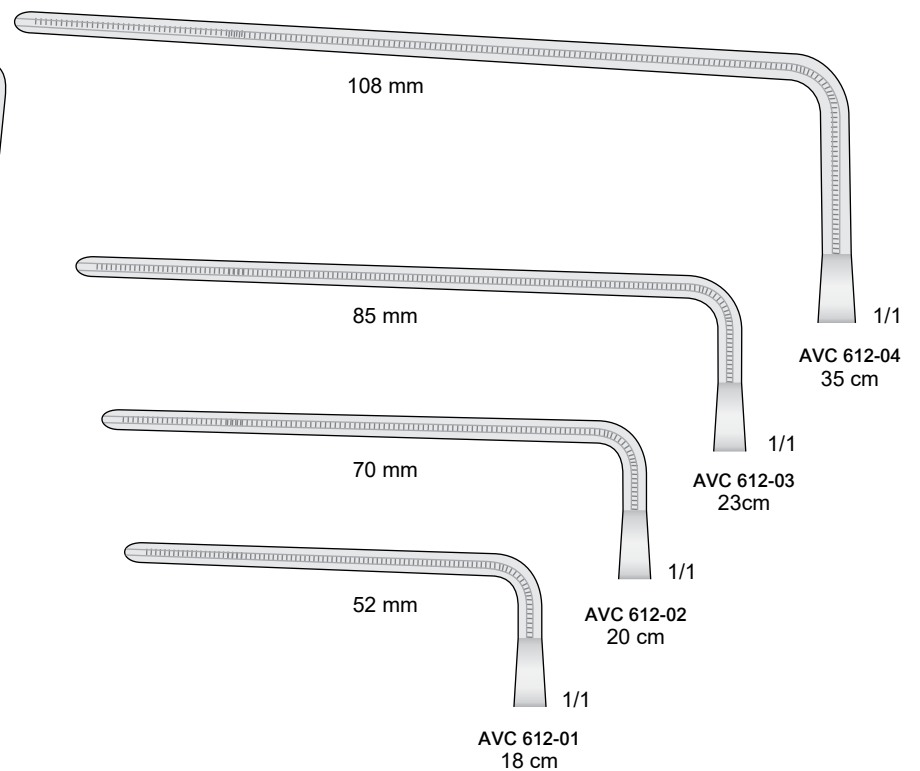

Pinze atraumatiche
Atraumatic vessel clamps
Atraumatische Gefäßklemmen
Pincés vasculaires atrauma
Pinzas vasculares atraumáticas

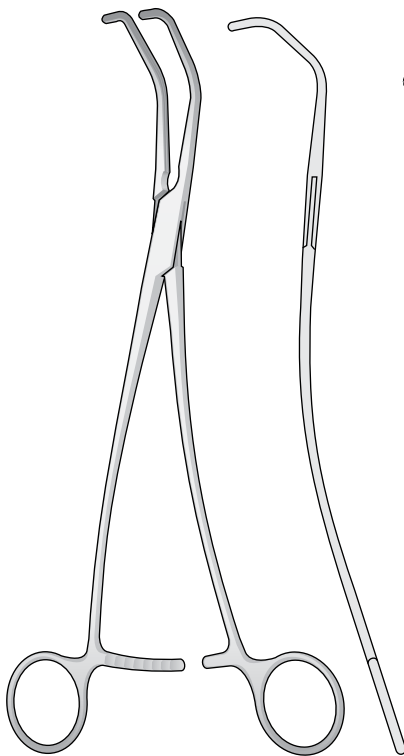

De BAKEY-SATINSKY
AVC 613-01 / AVC 613-03

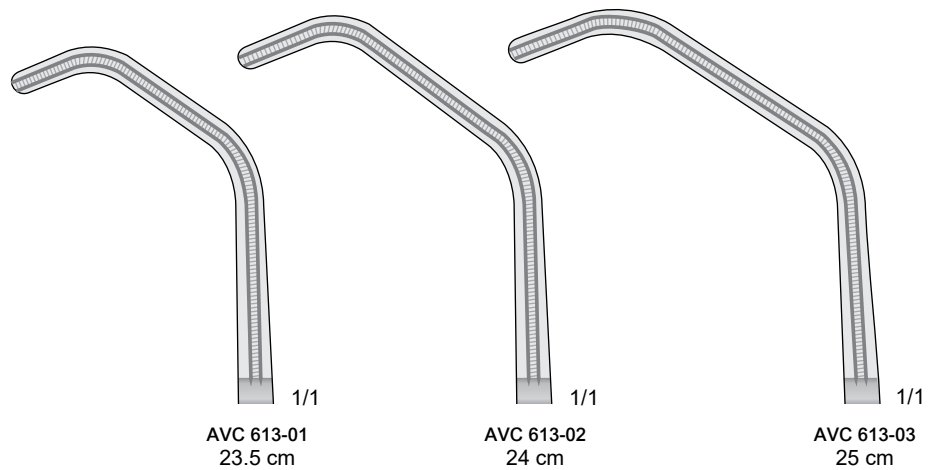

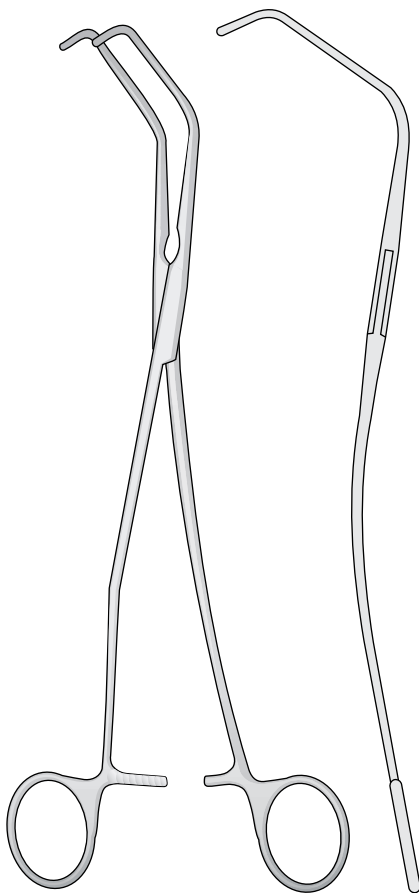
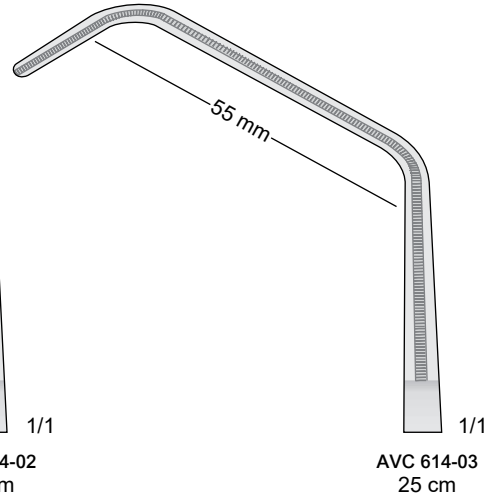
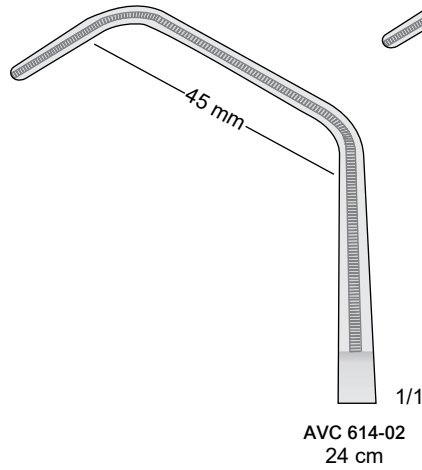
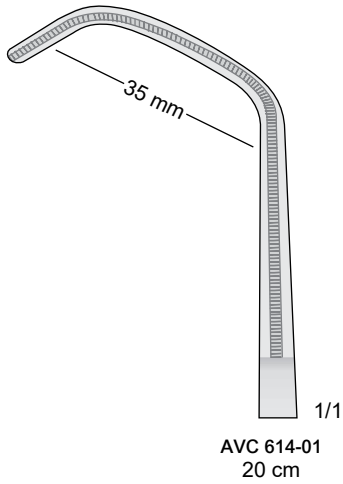

De-BAKEY

AVC 614-01 / AVC 614-05

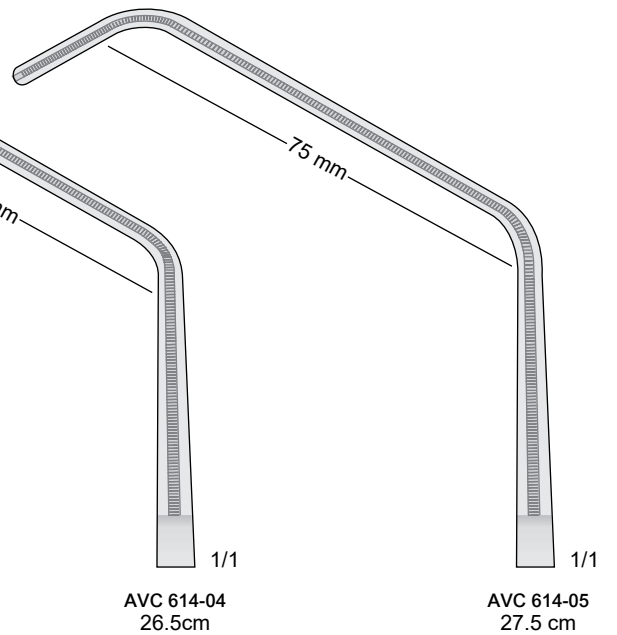
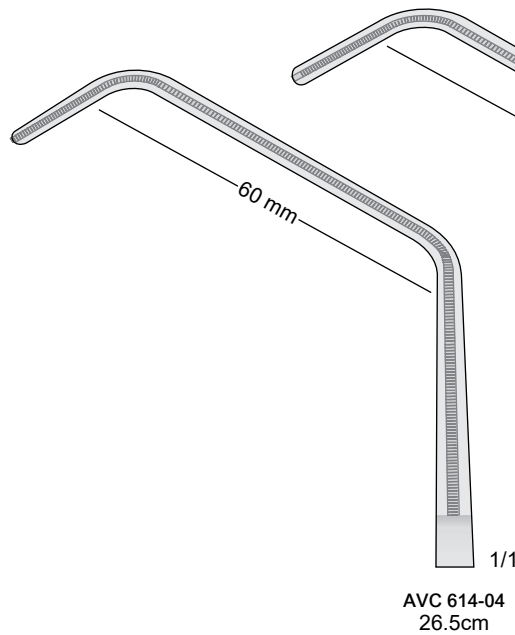

Pinze atraumatiche
Atraumatic vessel clamps
Atraumatische Gefäßklemmen
Pincés vasculaires atrauma
Pinzas vasculares atraumáticas

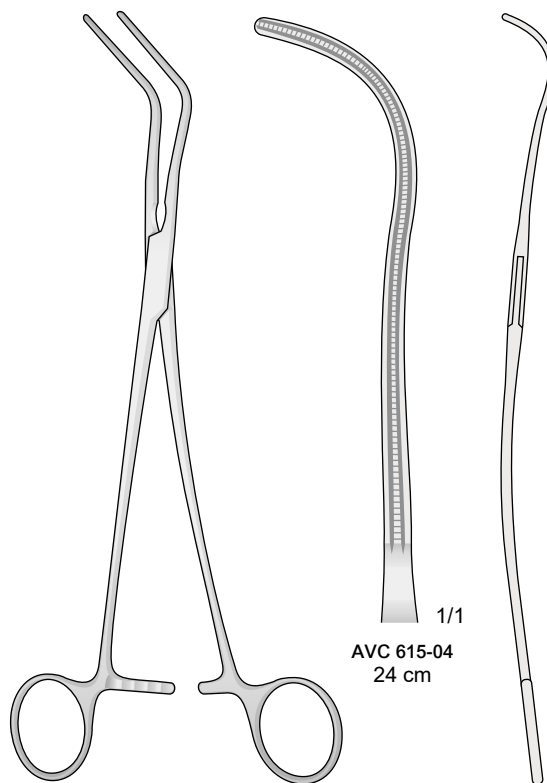
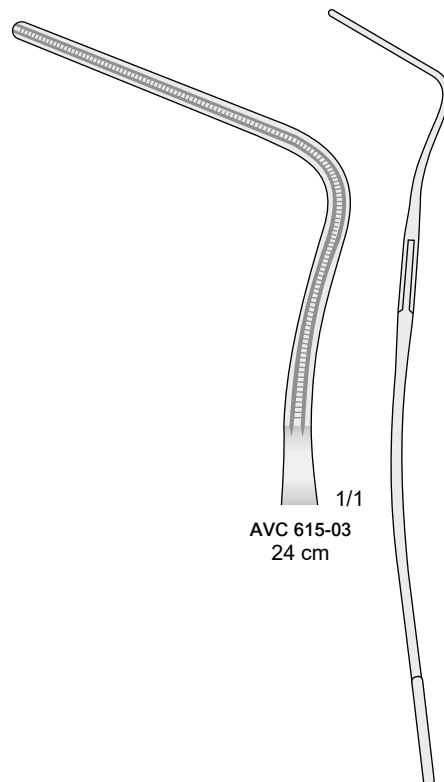
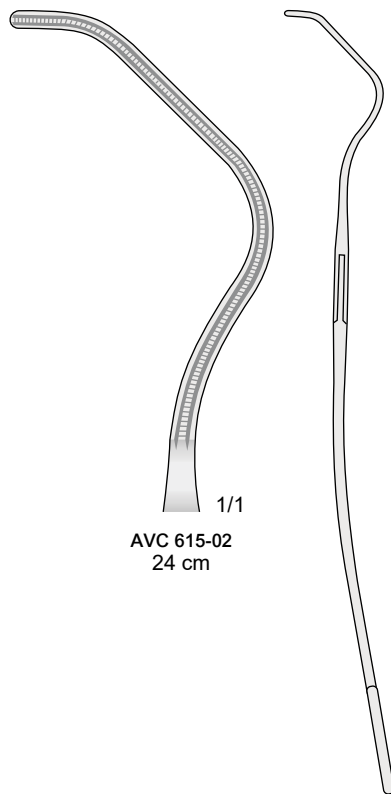
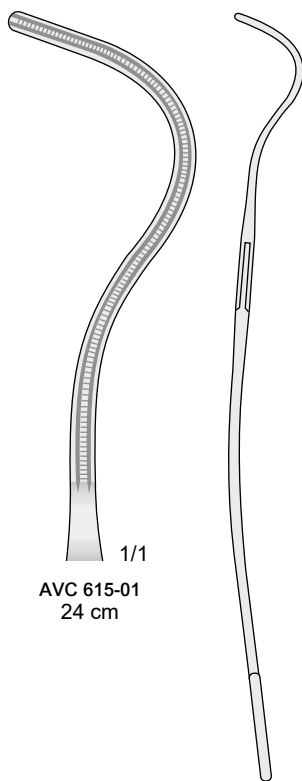

De BAKEY-HARKEN
AVC 615-01 / AVC 615-04

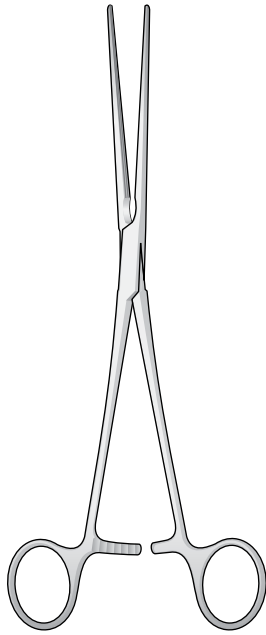

De BAKEY

AVC 616-01 / AVC 616-04



1/1

AVC 616-01
21.5 cm

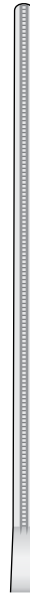

1/1

AVC 616-02
23 cm



1/1

AVC 616-03
27 cm



1/1

AVC 616-04
31.5 cm

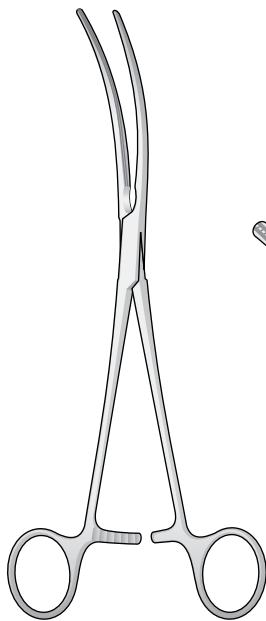

De BAKEY

AVC 617-01 / AVC 617-04

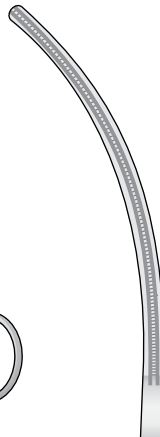

1/1

AVC 617-01
21.5 cm

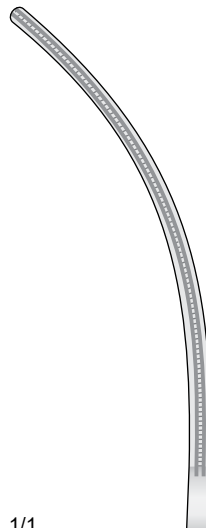

1/1

AVC 617-02
23 cm

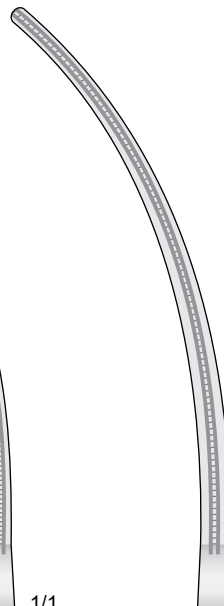

1/1

AVC 617-03
27 cm

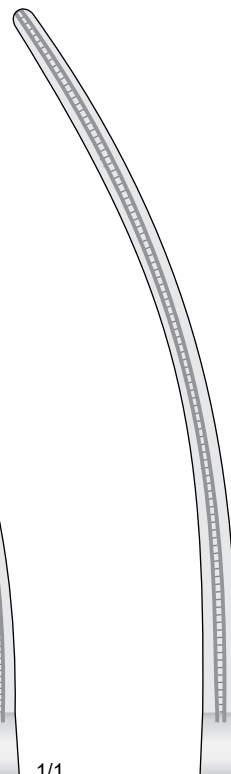

1/1

AVC 617-04
31 cm

Pinze atraumatiche
Atraumatic vessel clamps
Atraumatische Gefäßklemmen
Pincés vasculaires atrauma
Pinzas vasculares atraumáticas

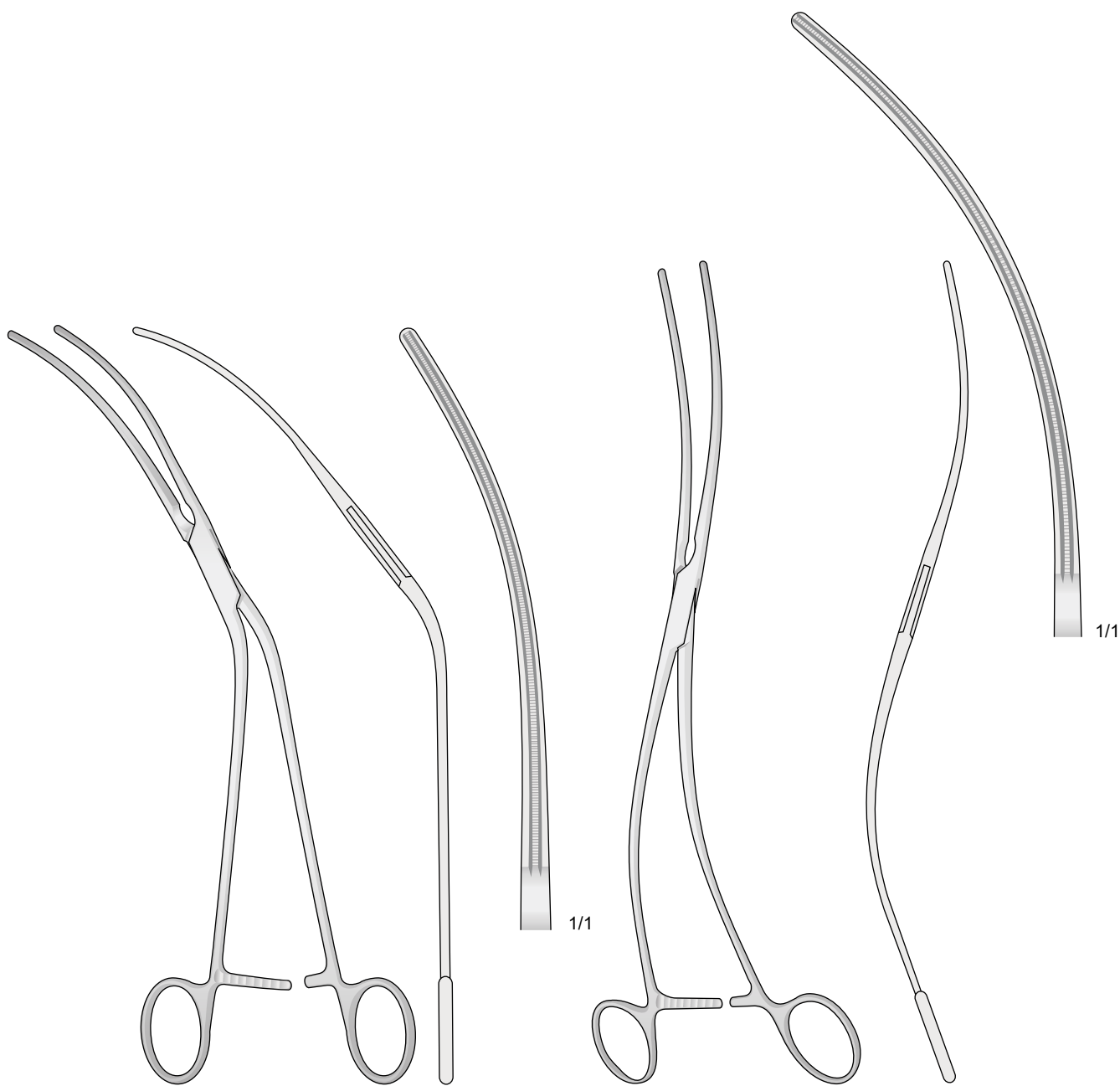

De BAKEY
AVC 618-28 28 cm

AVC 619-30 30 cm

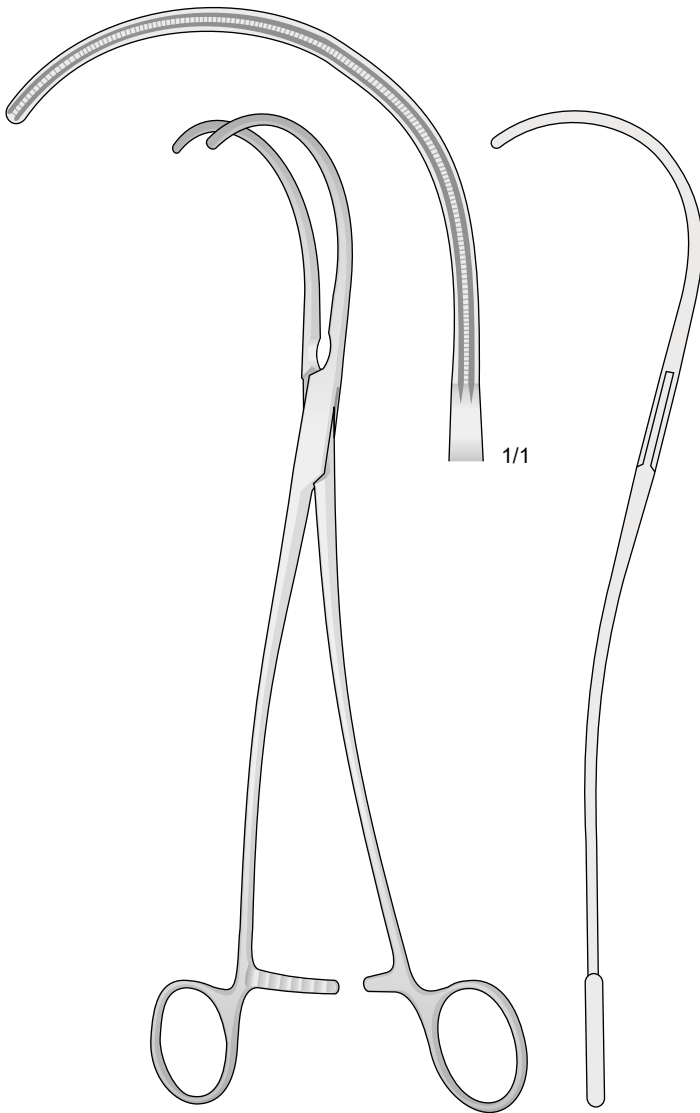

De BAKEY
AVC 620-26 26 cm

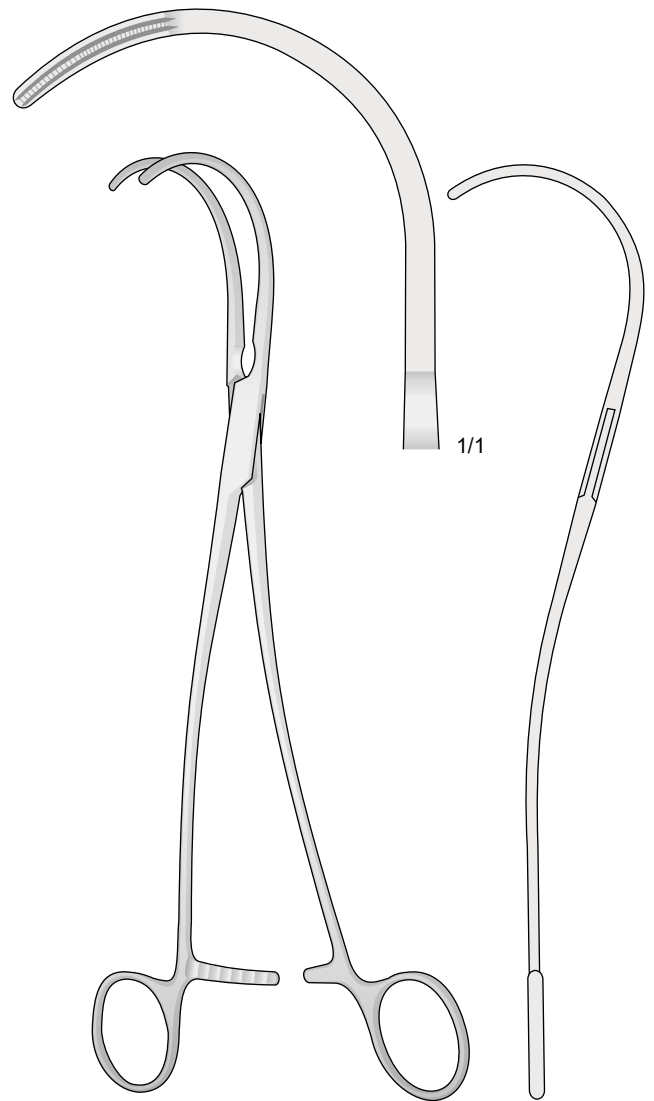

De BAKEY
AVC 621-25 25 cm

Pinze atraumatiche
Atraumatic vessel clamps
Atraumatische Gefäßklemmen
Pincés vasculaires atrauma
Pinzas vasculares atraumáticas

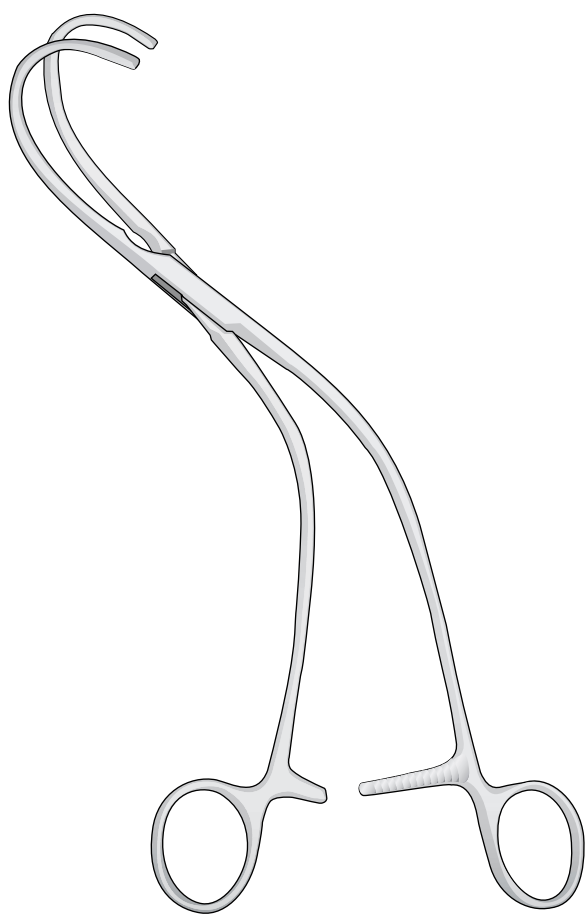
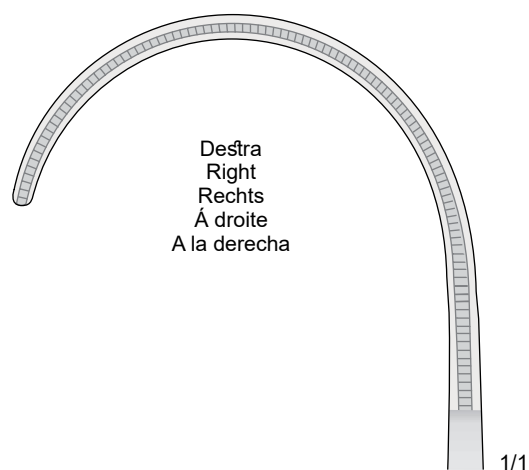
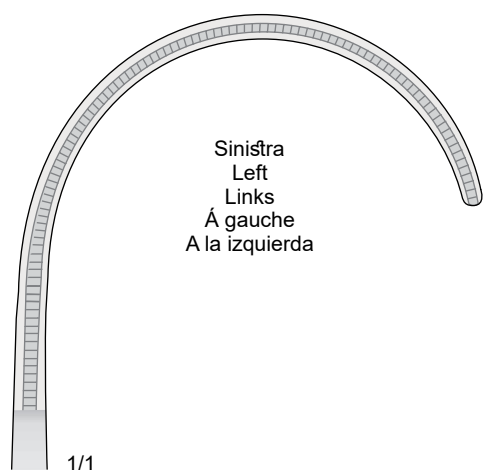

WEBER
AVC 622-26 26 cm

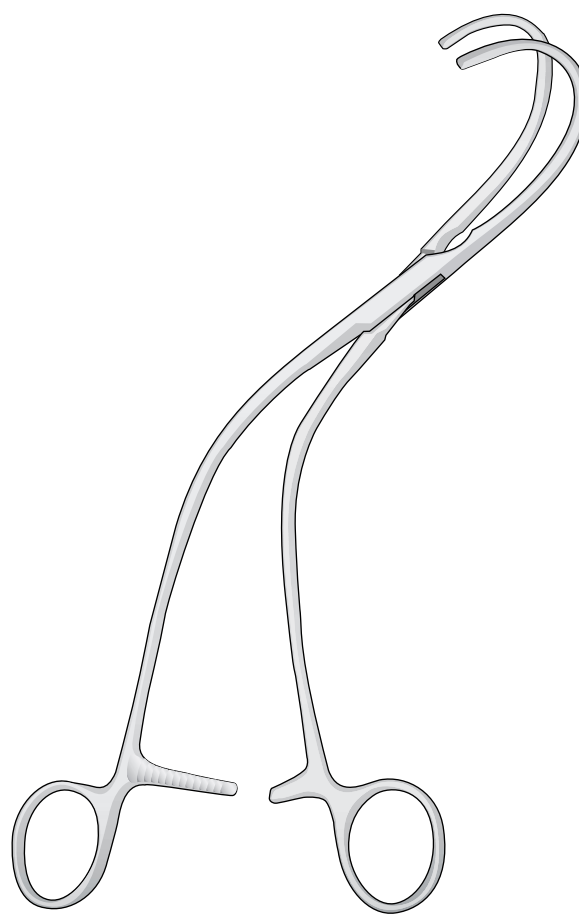

WEBER
AVC 623-26 26 cm



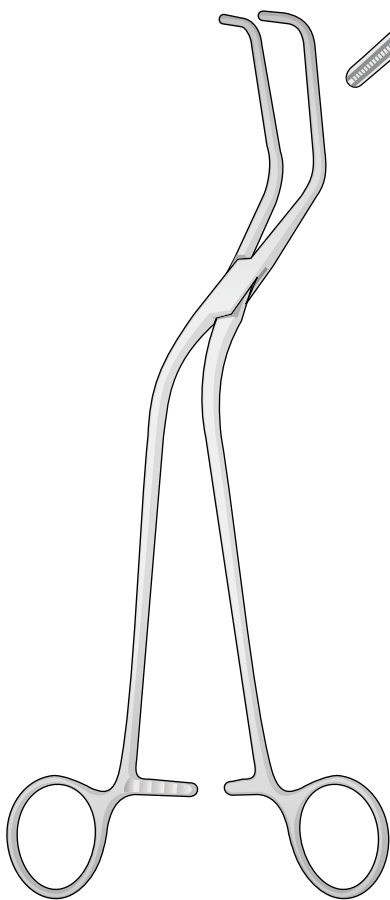

OCHSNER
AVC 624-23 23.5 cm

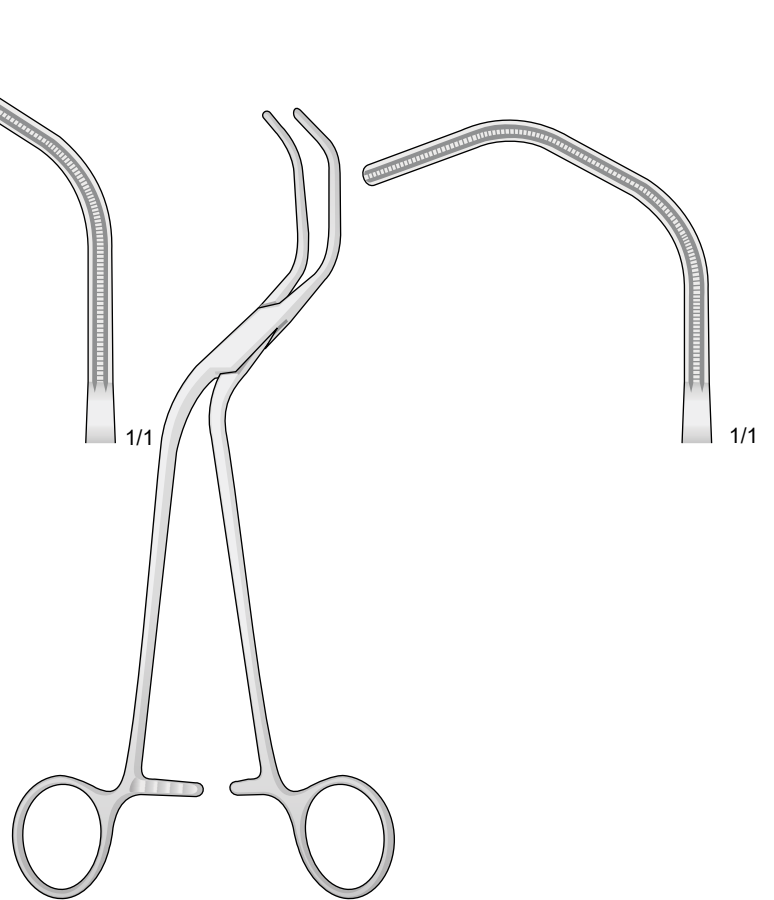

DIETRICH
AVC 625-21 21 cm

Pinze atraumatiche
Atraumatic vessel clamps
Atraumatische Gefäßklemmen
Pincés vasculaires atrauma
Pinzas vasculares atraumáticas

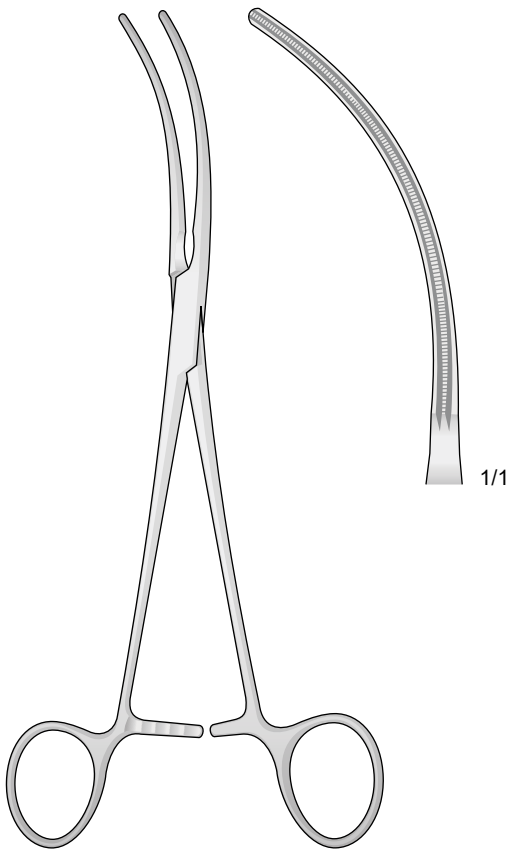

POTTS
AVC 626-22 22 cm

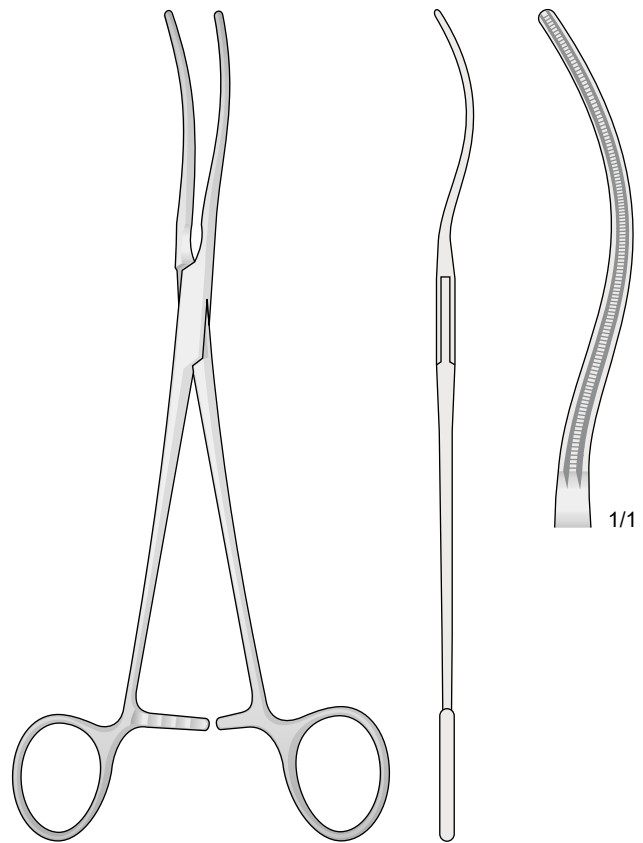

POTTS
AVC 627-22 22 cm

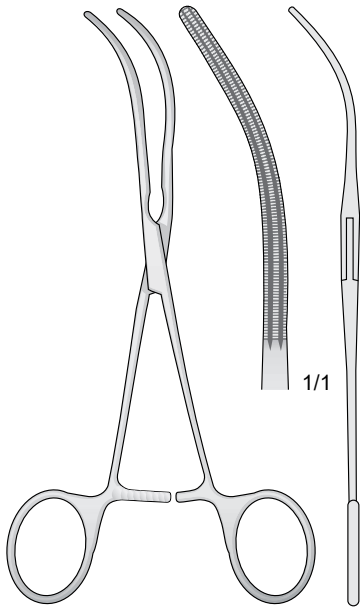

GLOVER

AVC 628-17 17 cm

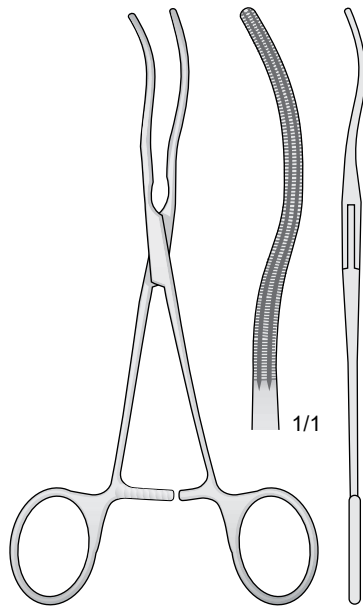

AVC 629-17 17 cm

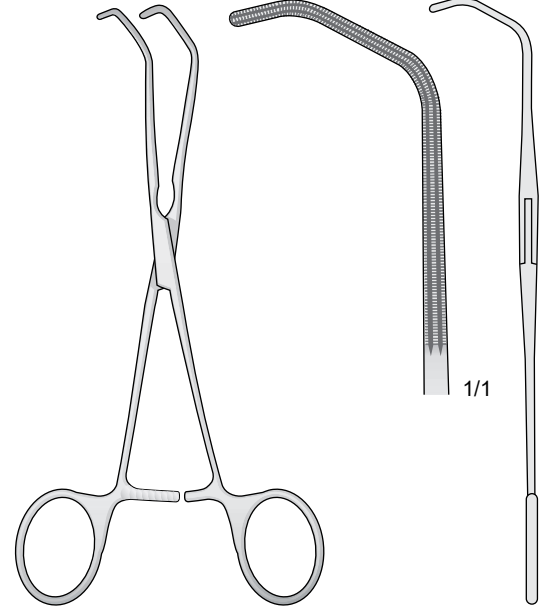

BECK

AVC 630-17 17 cm

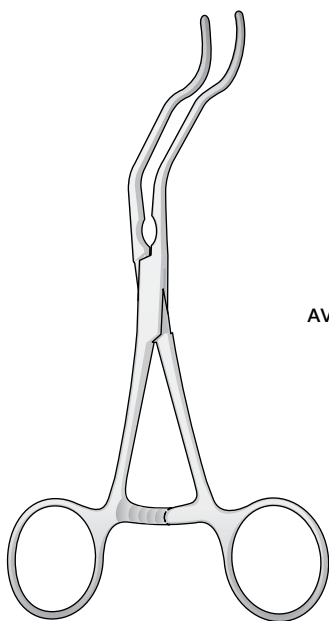

GREGORY

AVC 631-01 / AVC 631-03



AVC 631-01
14 cm



AVC 631-02
16 cm



AVC 631-03
18 cm

Pinze atraumatiche
 Atraumatic vessel clamps
 Atraumatische Gefäßklemmen
 Pincés vasculares atrauma
 Pinzas vasculares atraumáticas

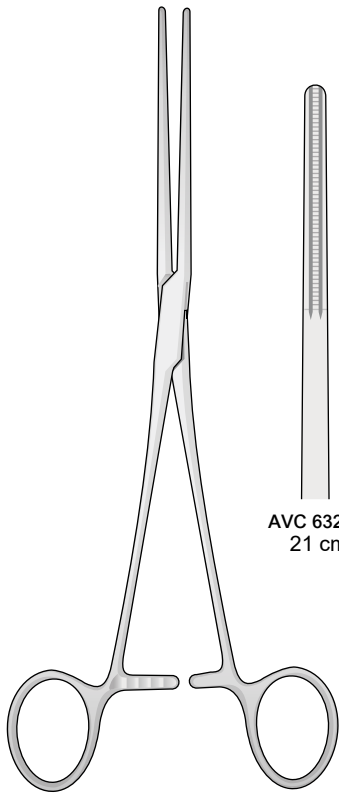

POTTS

AVC 632-01 / AVC 632-02

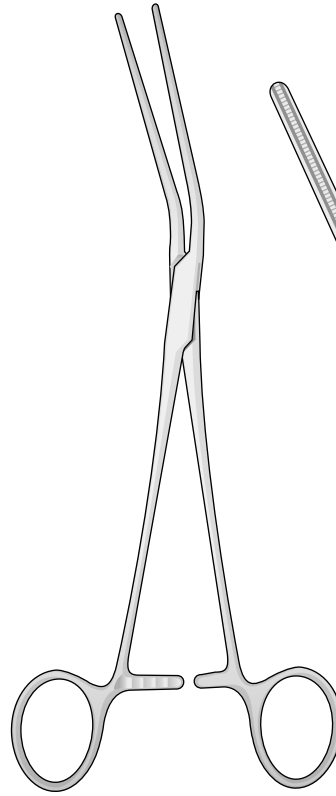
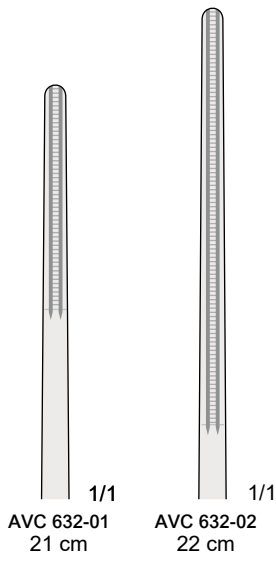

POTTS

AVC 633-01 / AVC 633-02

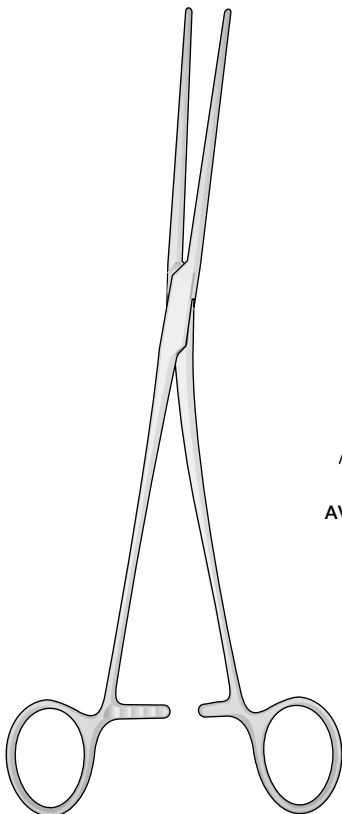
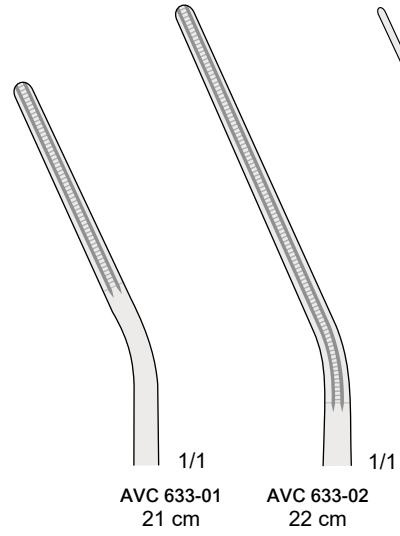

POTTS

AVC 634-01 / AVC 634-02

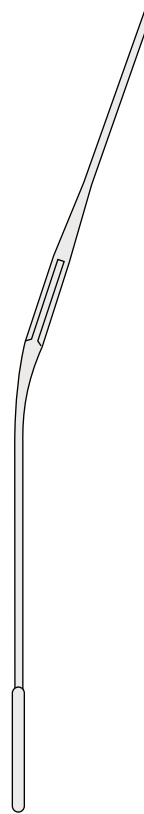
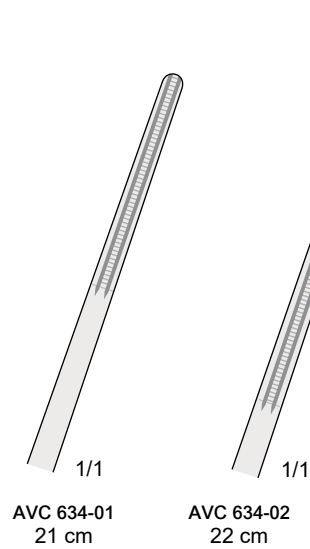

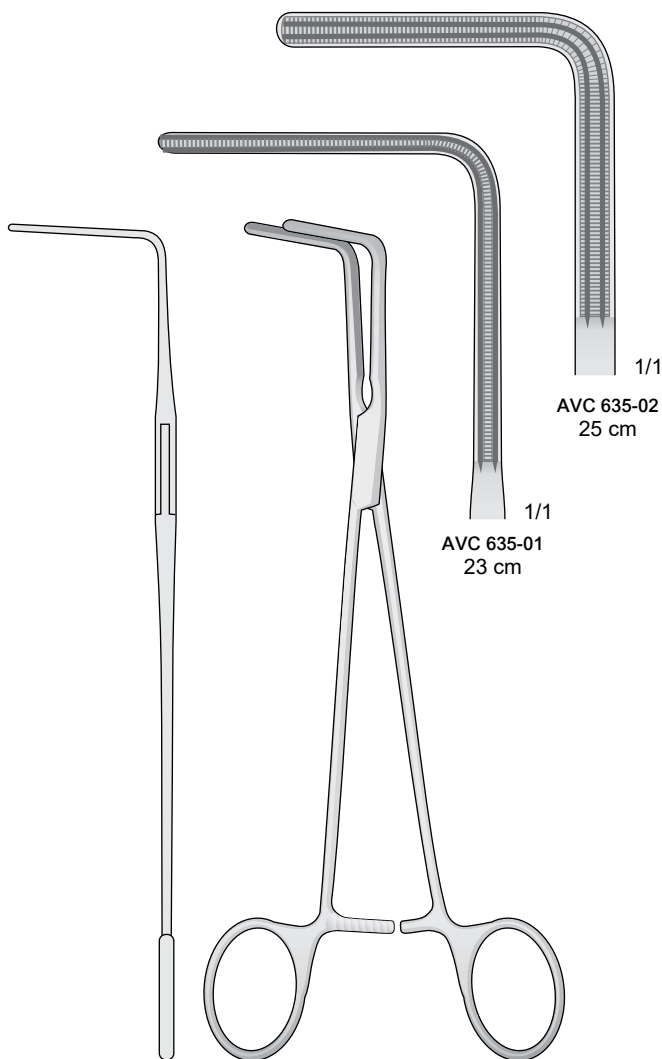

LEES

AVC 635-01 / AVC 635-02

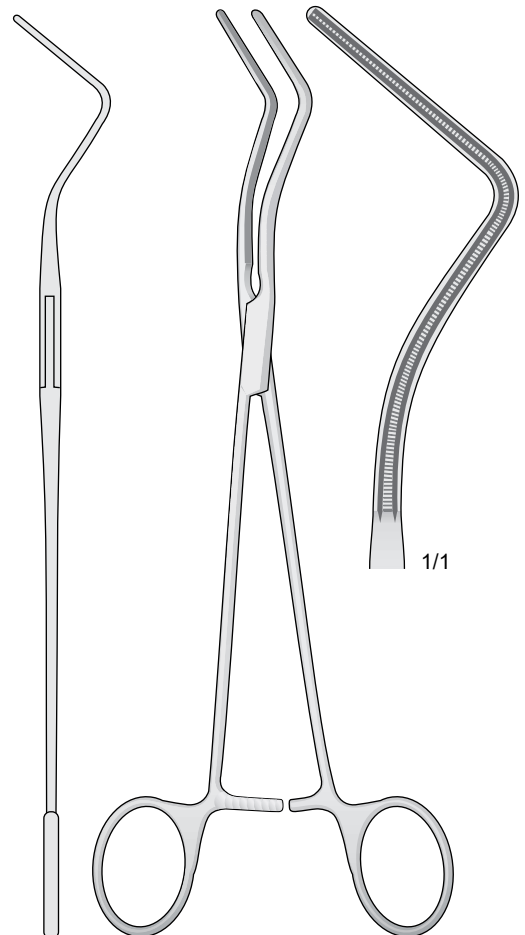

LEES

AVC 636-25 25 cm

Pinze atraumatiche
Atraumatic vessel clamps
Atraumatische Gefäßklemmen
Pincés vasculaires atrauma
Pinzas vasculares atraumáticas

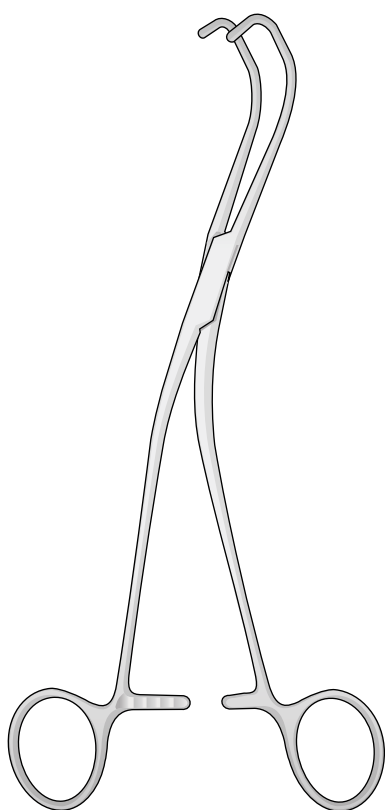

LAMBERT-KAY
AVC 637-01 / AVC 637-02

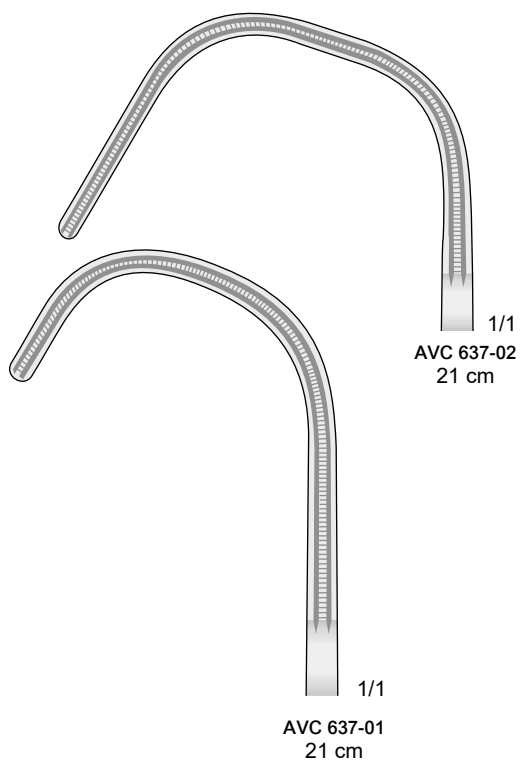
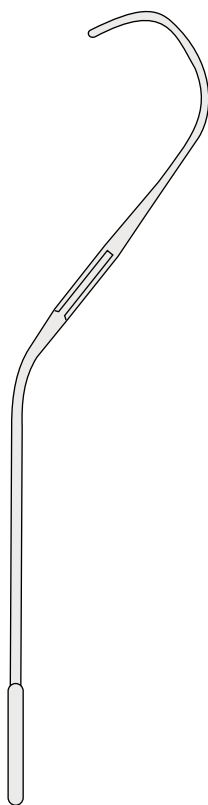

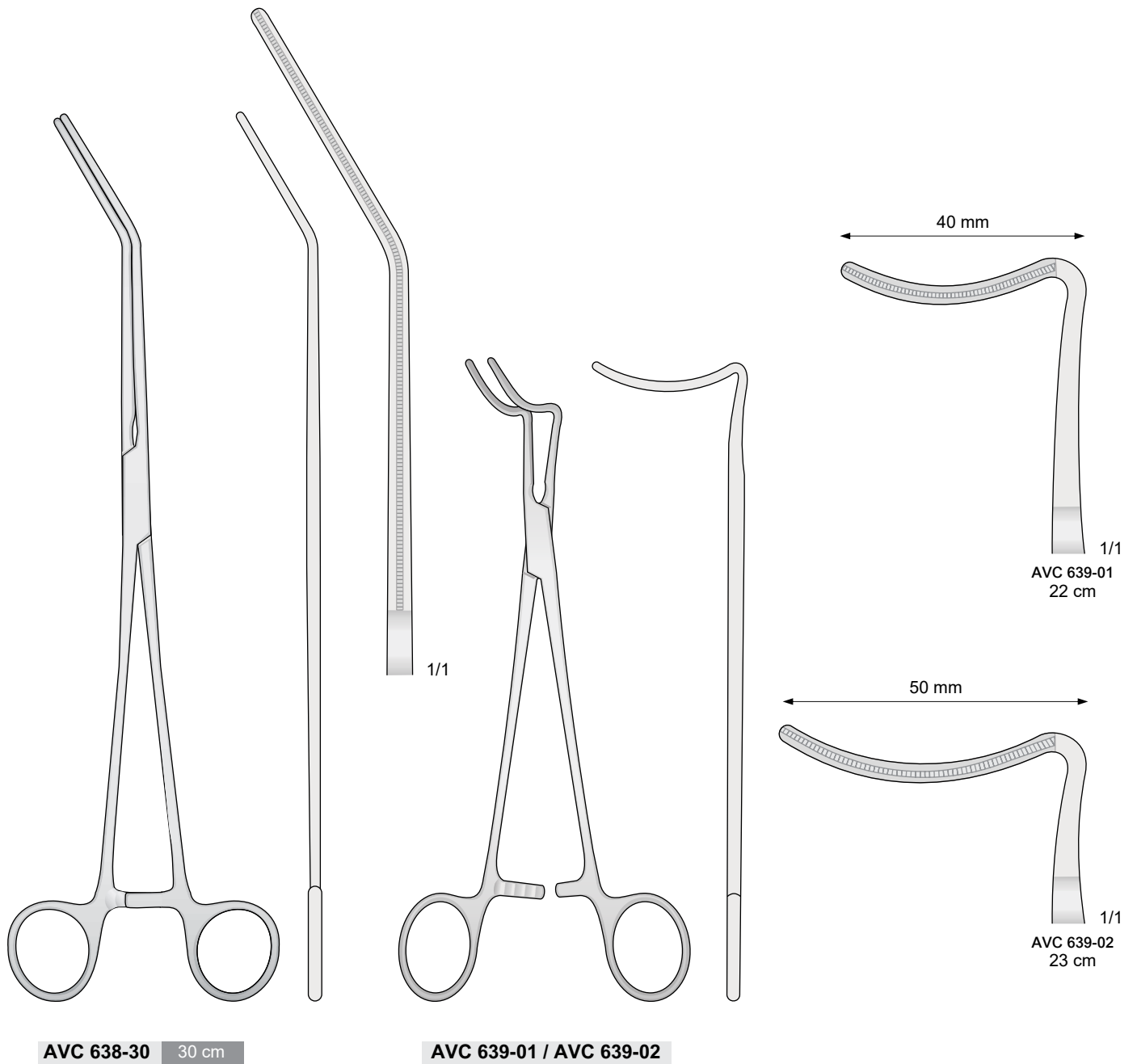

Pinze atraumatiche
 Atraumatic vessel clamps
 Atraumatische Gefäßklemmen
 Pinces vasculaires atrauma
 Pinzas vasculares atraumáticas

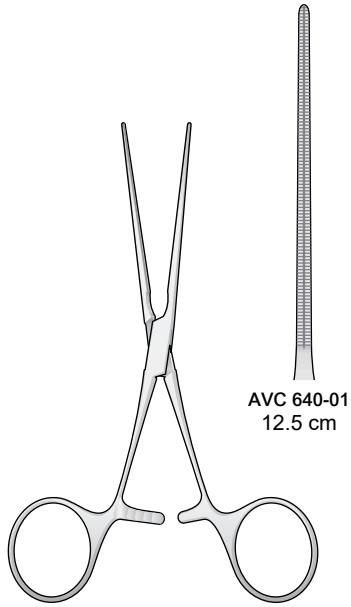

AVC 640-01
12.5 cm

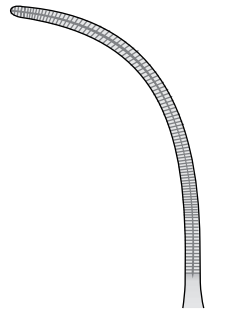

AVC 640-02
11.5 cm

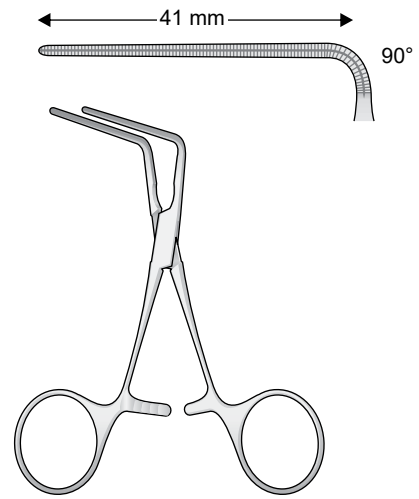

COOLEY
AVC 641-10 10 cm

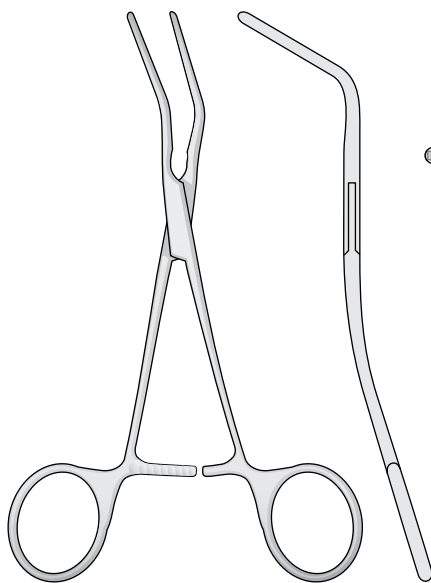

COOLEY
AVC 642-01 / AVC 642-02

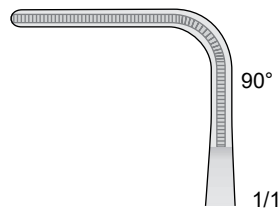

AVC 642-01
14 cm

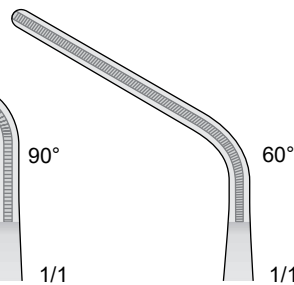

AVC 642-02
14 cm

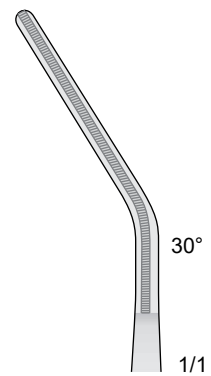

AVC 642-03
14 cm

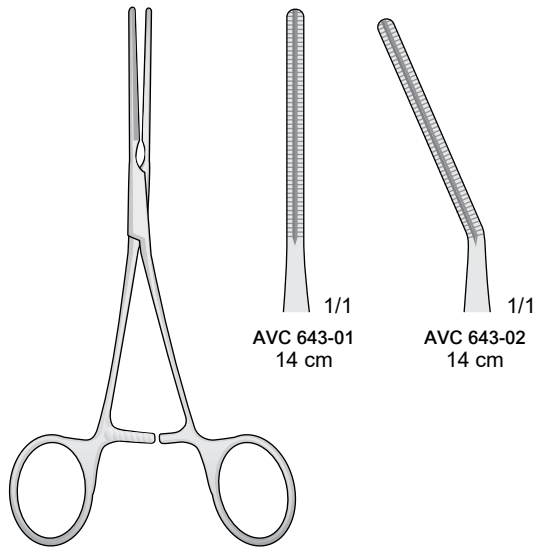

COOLEY

AVC 643-01 / AVC 643-02

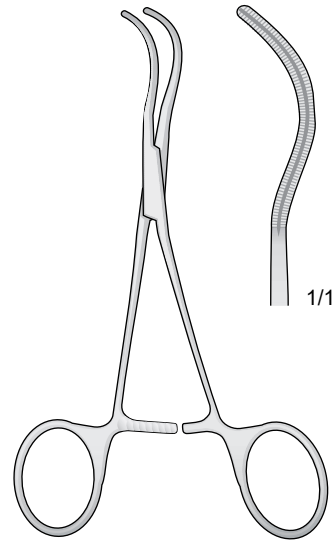

COOLEY

AVC 644-14 14 cm

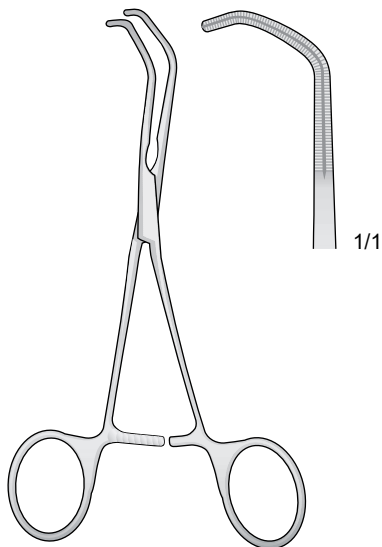

COOLEY

AVC 645-14 14 cm

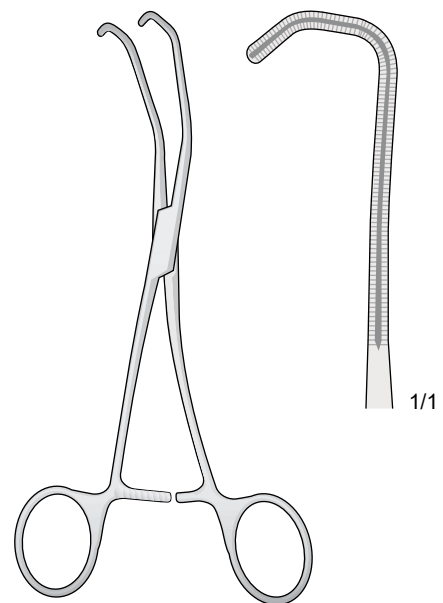

COOLEY

AVC 646-16 16 cm

Pinze atraumatiche
 Atraumatic vessel clamps
 Atraumatische Gefäßklemmen
 Pincés vasculaires atrauma
 Pinzas vasculares atraumáticas

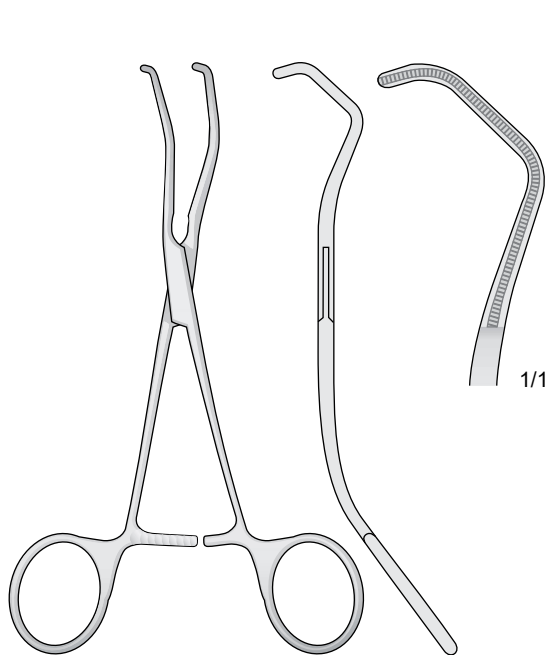

COOLEY
AVC 647-16 16 cm

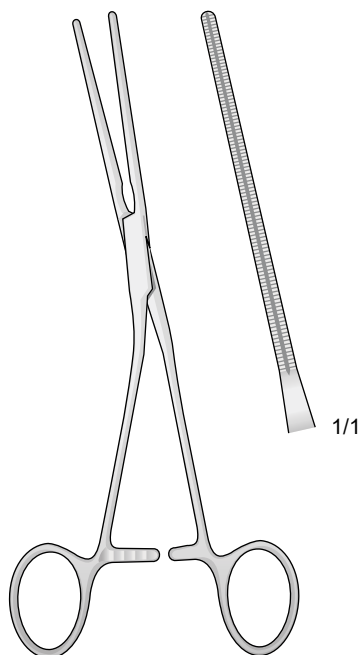

COOLEY
AVC 648-17 17 cm

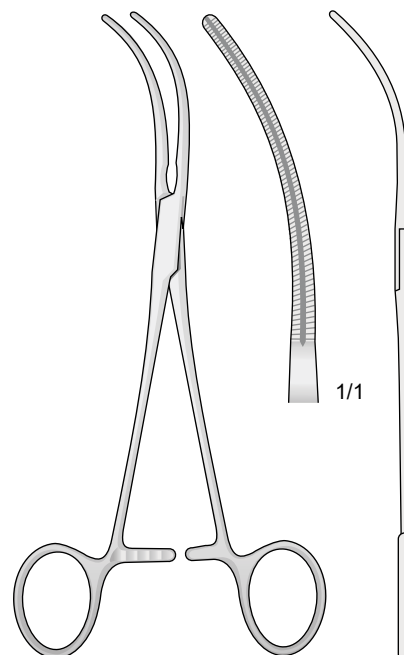

COOLEY
AVC 649-17 17 cm

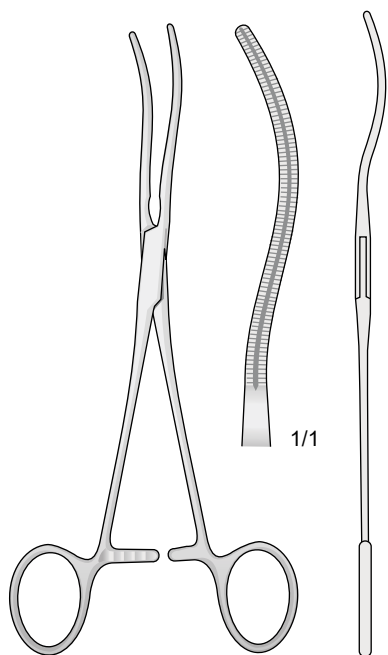

COOLEY
AVC 650-17 17 cm

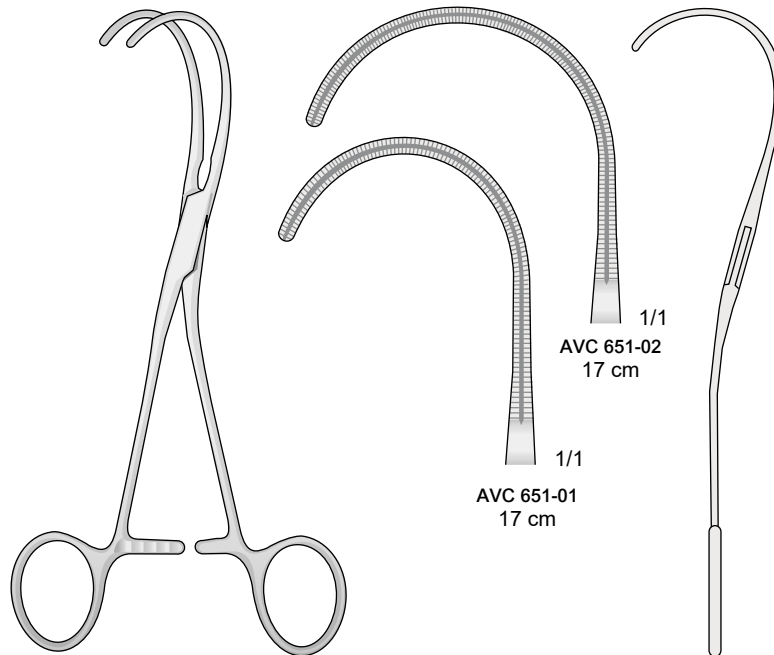

COOLEY
AVC 651-01 / AVC 651-02

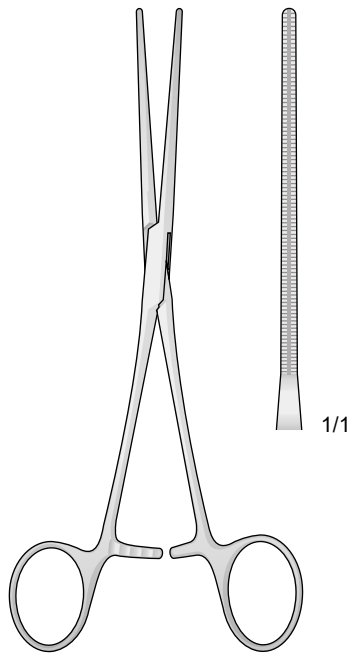

COOLEY

AVC 652-17 17 cm

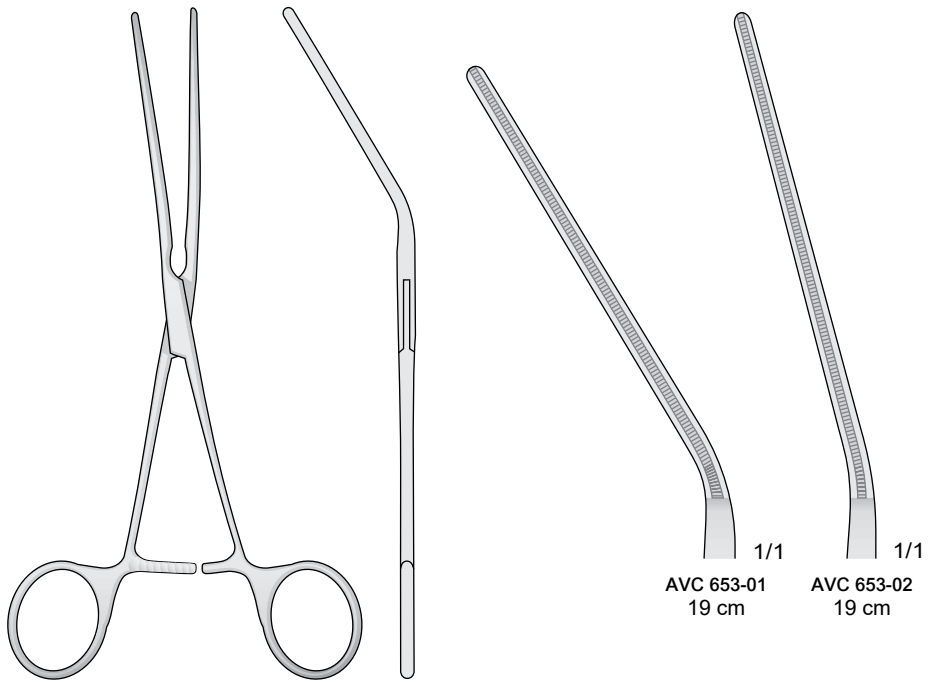

LELAND - JONES

AVC 653-01 / AVC 653-02

Pinze atraumatiche
 Atraumatic vessel clamps
 Atraumatische Gefäßklemmen
 Pincés vasculaires atrauma
 Pinzas vasculares atraumáticas

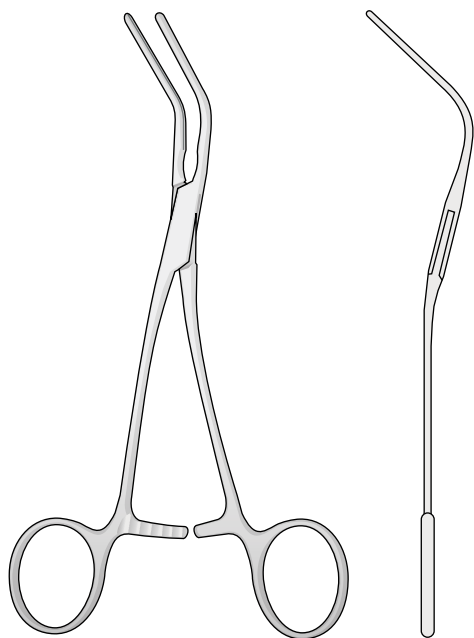

COOLEY
AVC 654-01 / AVC 654-03

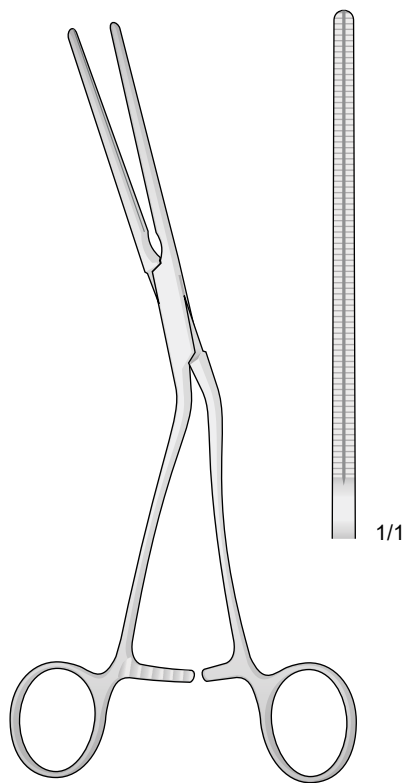
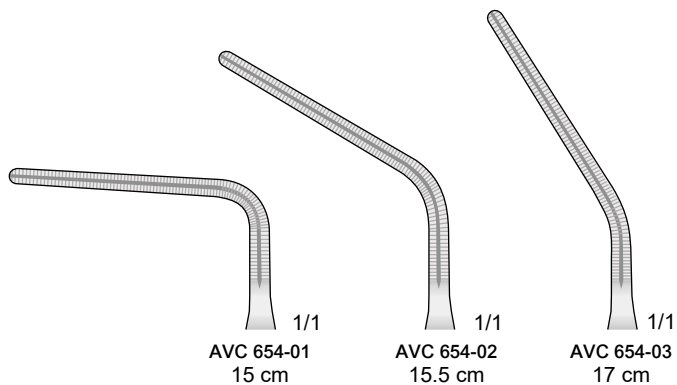

COOLEY
AVC 655-21 21 cm

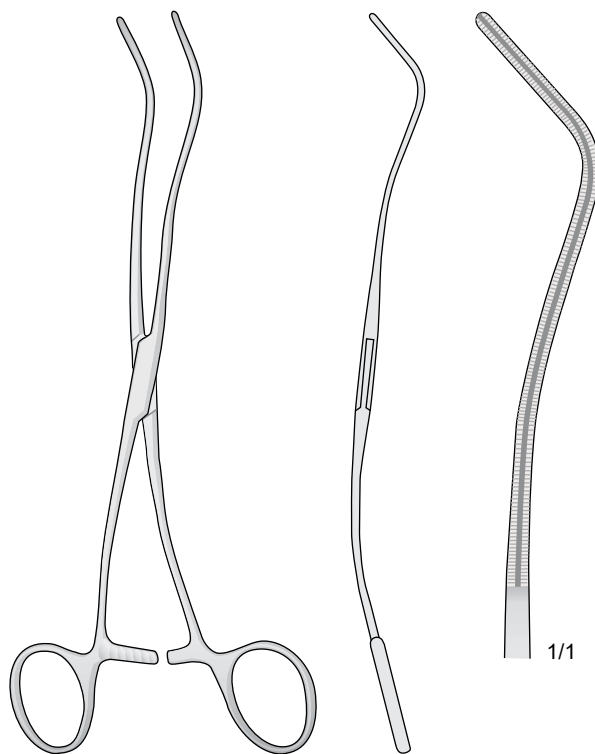

COOLEY
AVC 656-20 20 cm

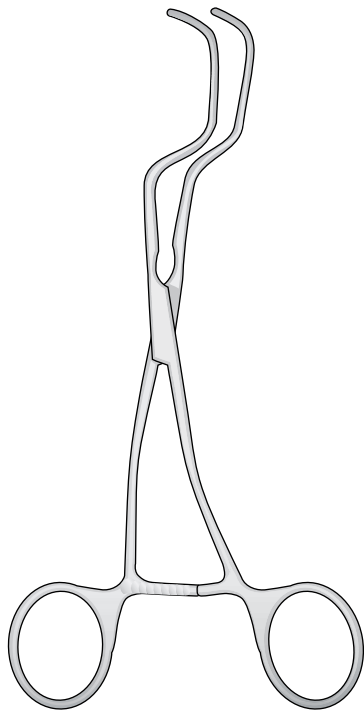

DALE
AVC 657-18 18.5 cm

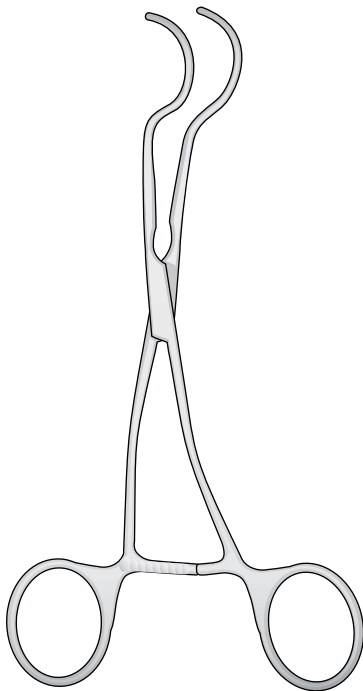
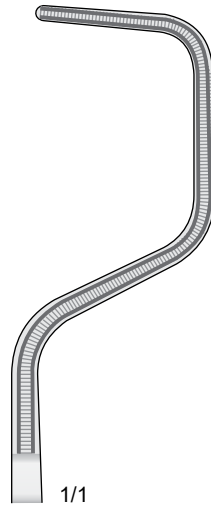

DALE
AVC 658-01 / AVC 658-03

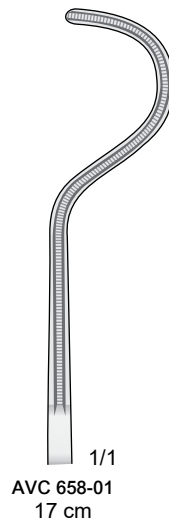

AVC 658-01
17 cm

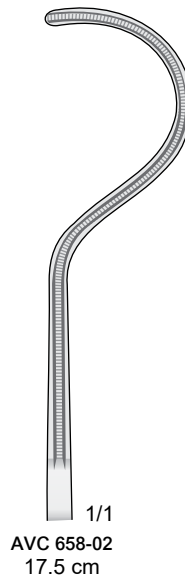

AVC 658-02
17.5 cm

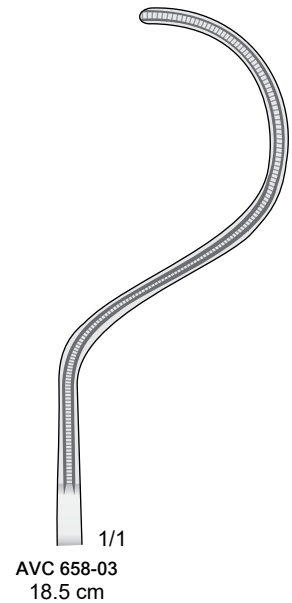

AVC 658-03
18.5 cm

Pinze atraumatiche
Atraumatic vessel clamps
Atraumatische Gefäßklemmen
Pincés vasculaires atrauma
Pinzas vasculares atraumáticas

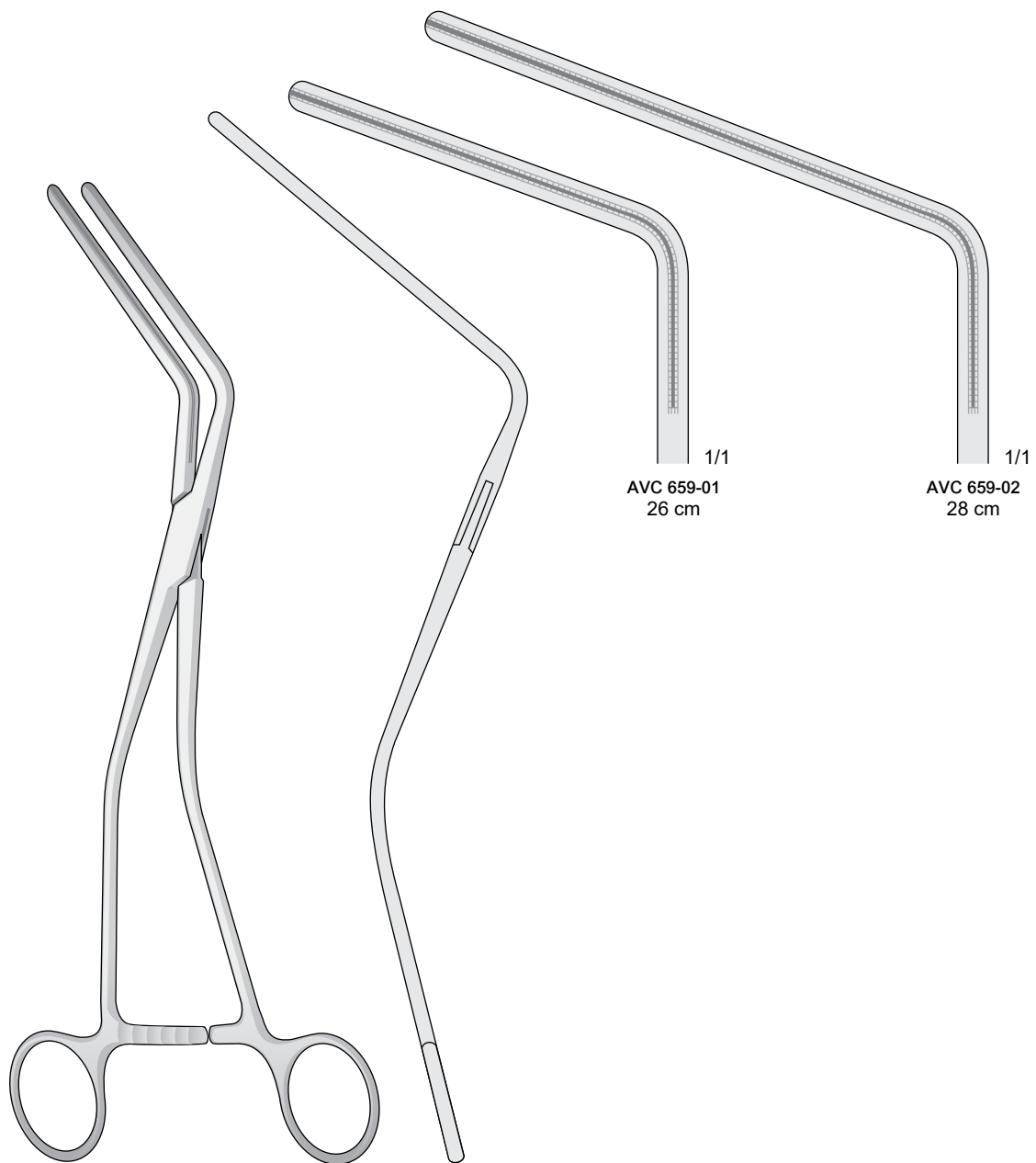

HAYES
AVC 659-01 / AVC 659-02

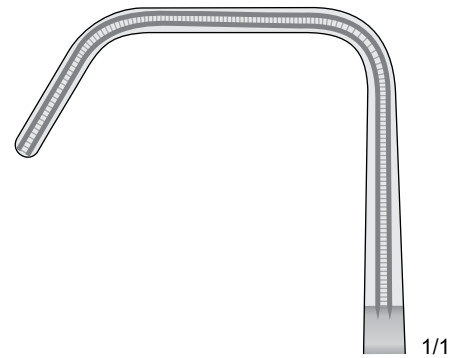

1/1
AVC 660-01
4 cm

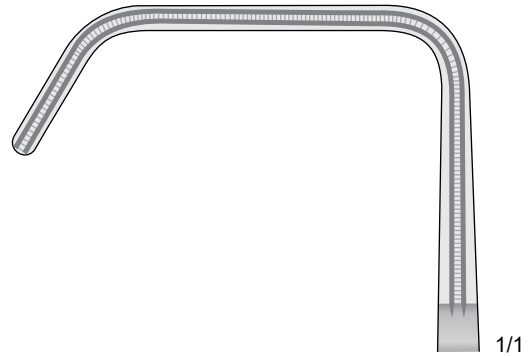

1/1



1/1

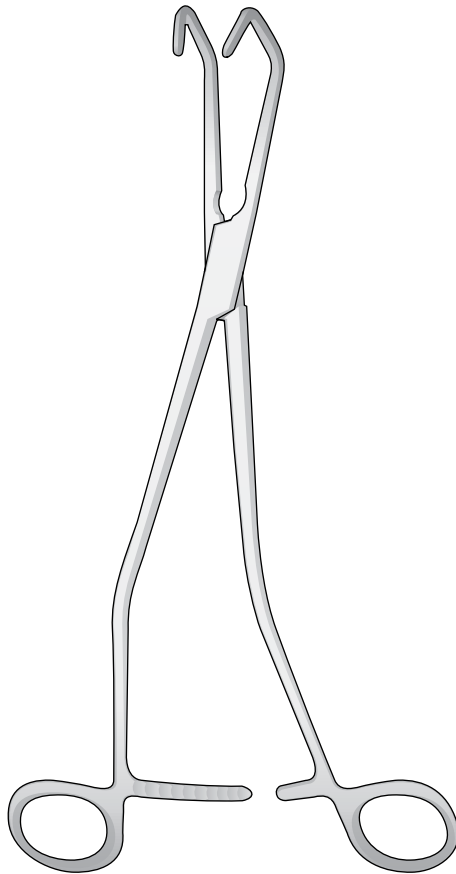

HOPT

AVC 660-01	23 cm
AVC 660-02	23.5 cm
AVC 660-03	24 cm

AVC 660-03
6 cm

Pinze atraumatiche
Atraumatic vessel clamps
Atraumatische Gefäßklemmen
Pincés vasculaires atrauma
Pinzas vasculares atraumáticas

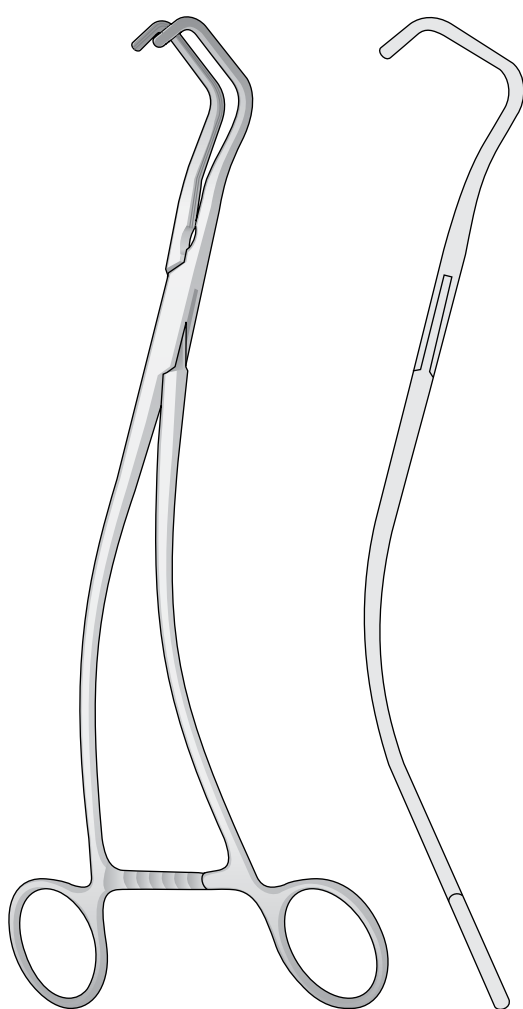

URO-TANGENTIAL
AVC 661-01 / AVC 661-02

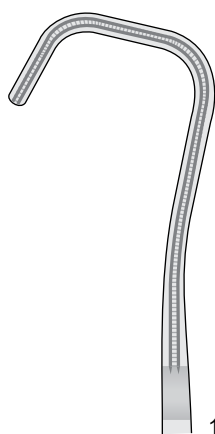

1/1
AVC 661-01
26 cm

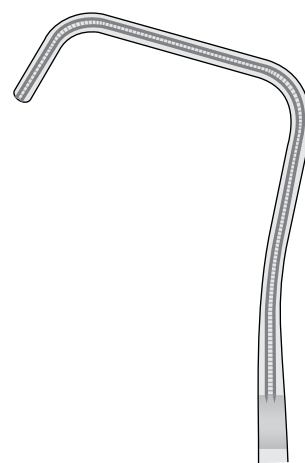

1/1
AVC 661-02
26 cm

Per bambini
For children
Kinderklemmen
Pour enfants
Para niños

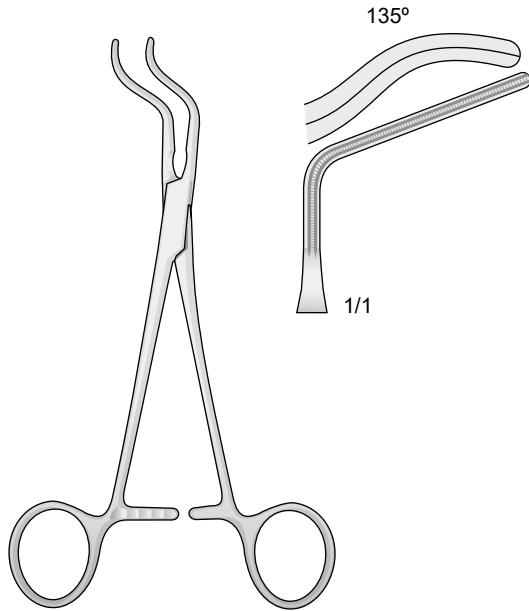

SUBRAMANIAN-MINIATURE

AVC 662-15 15.5 cm

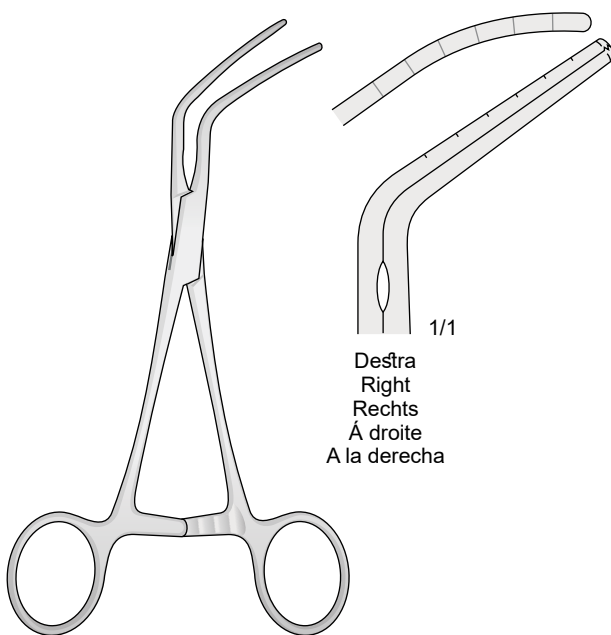

Destra
Right
Rechts
À droite
A la derecha

SUBRAMANIAN

AVC 663-16 16 cm

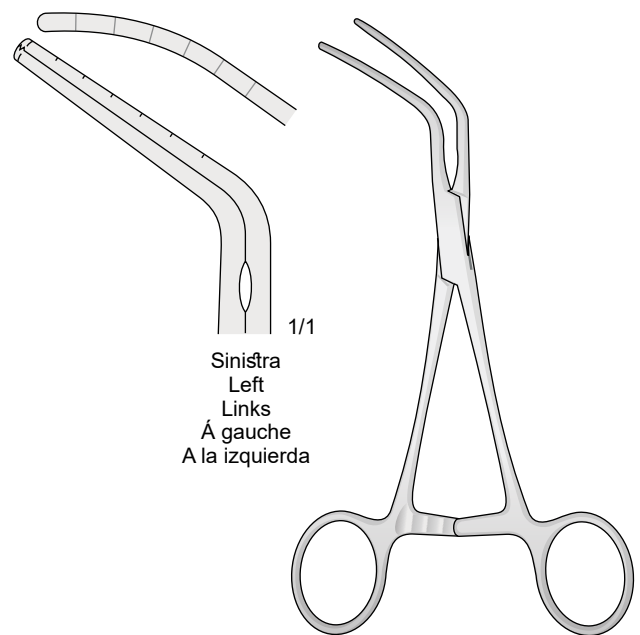

Sinistra
Left
Links
À gauche
A la izquierda

SUBRAMANIAN

AVC 664-16 16 cm

Pinze atraumatiche
Atraumatic vessel clamps
Atraumatische Gefäßklemmen
Pincés vasculaires atrauma
Pinzas vasculares atraumáticas

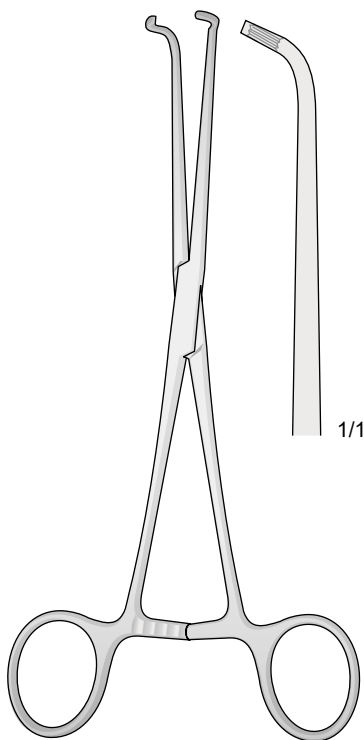

JAVID
AVC 665-18 18 cm

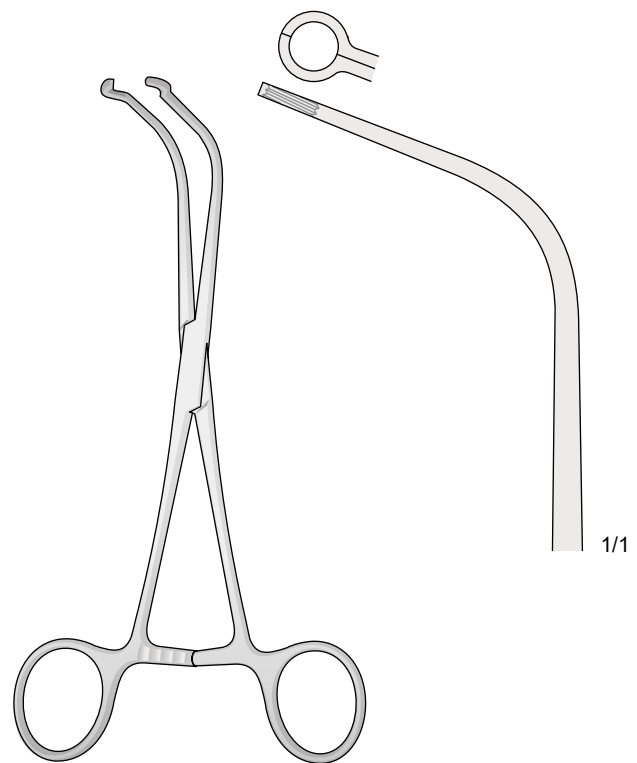

JAVID
AVC 666-19 19 cm

Atraumatiche - Atraumatic - Atraumatische
 Atraumatique - Atraumáticas

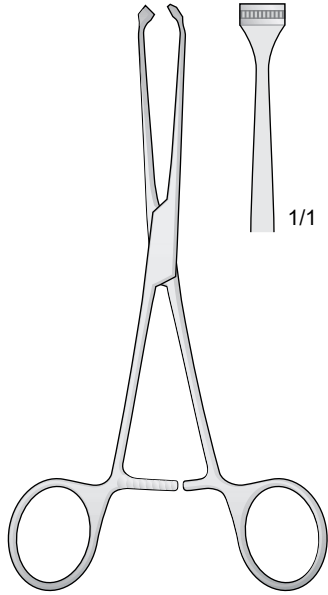

ALLIS
AVC 667-15 15 cm

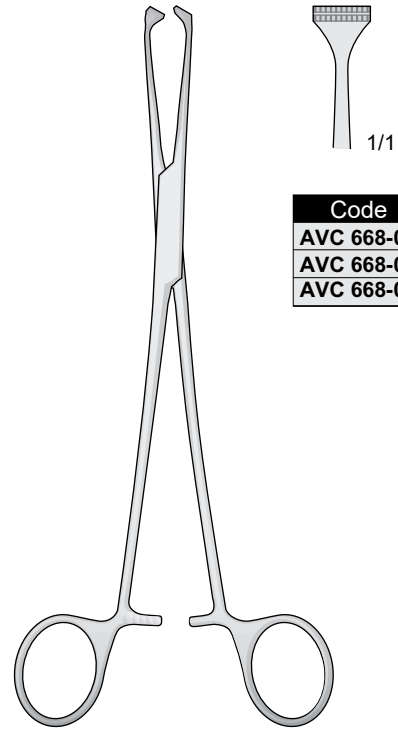

ALLIS
AVC 668-01 / AVC 668-03

Code	Size
AVC 668-01	19 cm
AVC 668-02	25 cm
AVC 668-03	30 cm

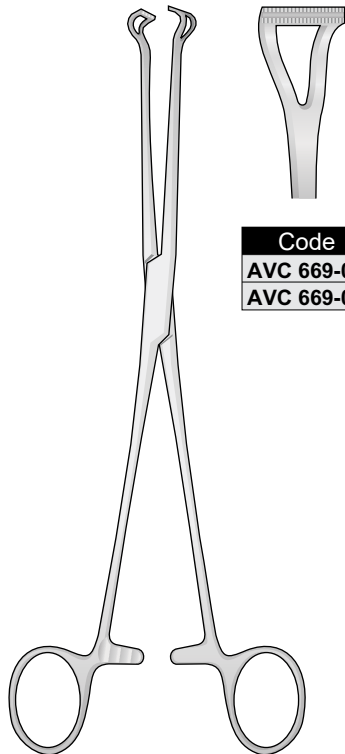

BABCOCK
AVC 669-01 / AVC 669-02

Code	Size
AVC 669-01	16 cm
AVC 669-02	20 cm

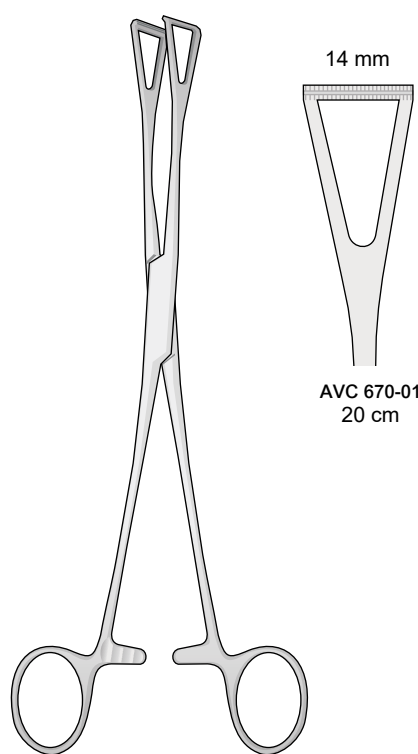

DUVAL
AVC 670-01 / AVC 670-02

Pinze atraumatiche
Atraumatic vessel clamps
Atraumatische Gefäßklemmen
Pincés vasculaires atrauma
Pinzas vasculares atraumáticas

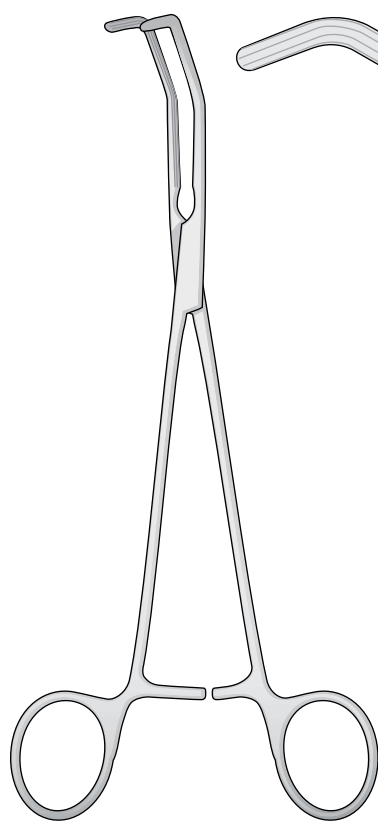

PRICE - THOMAS
AVC 671-22 22 cm

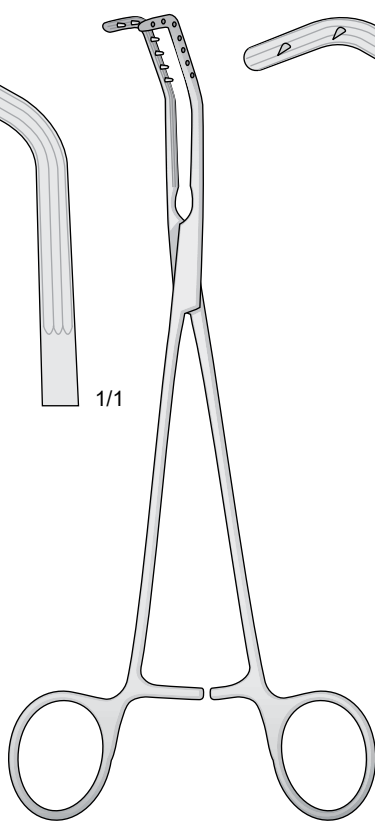

PRICE - THOMAS
AVC 672-01 / AVC 672-02

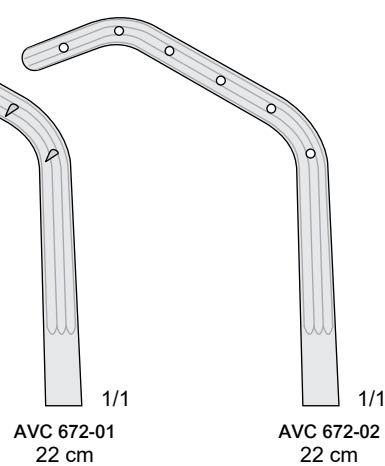

AVC 672-01
22 cm

AVC 672-02
22 cm

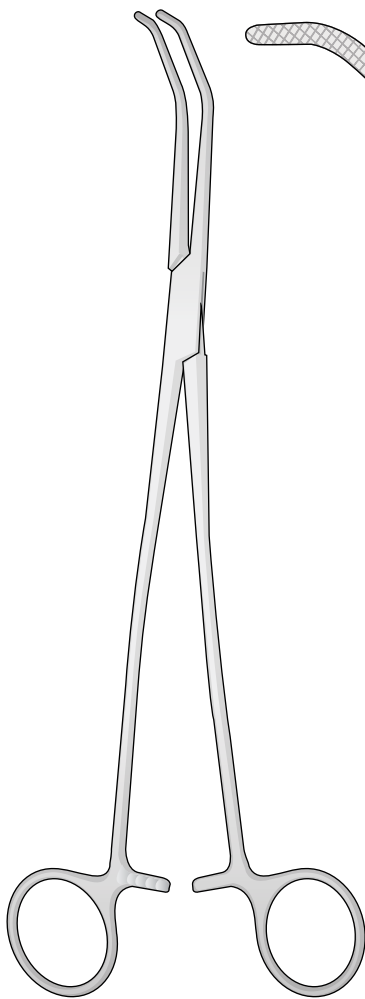

SATINSKY
AVC 673-01 / AVC 673-02

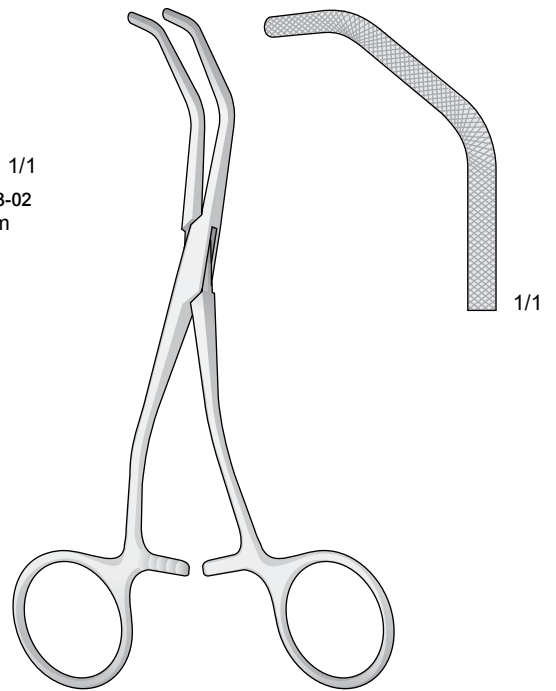
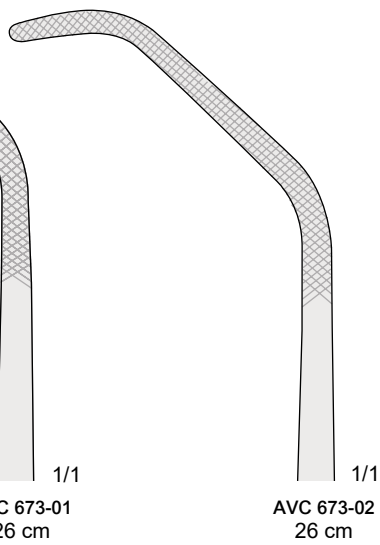
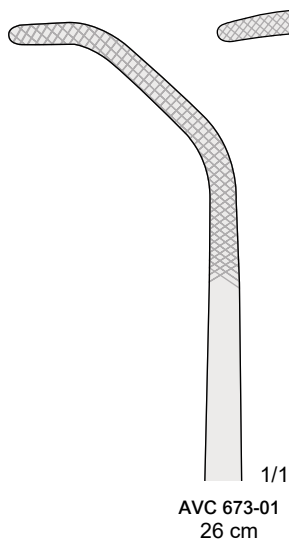

BABY-SATINSKY
AVC 674-15 15 cm

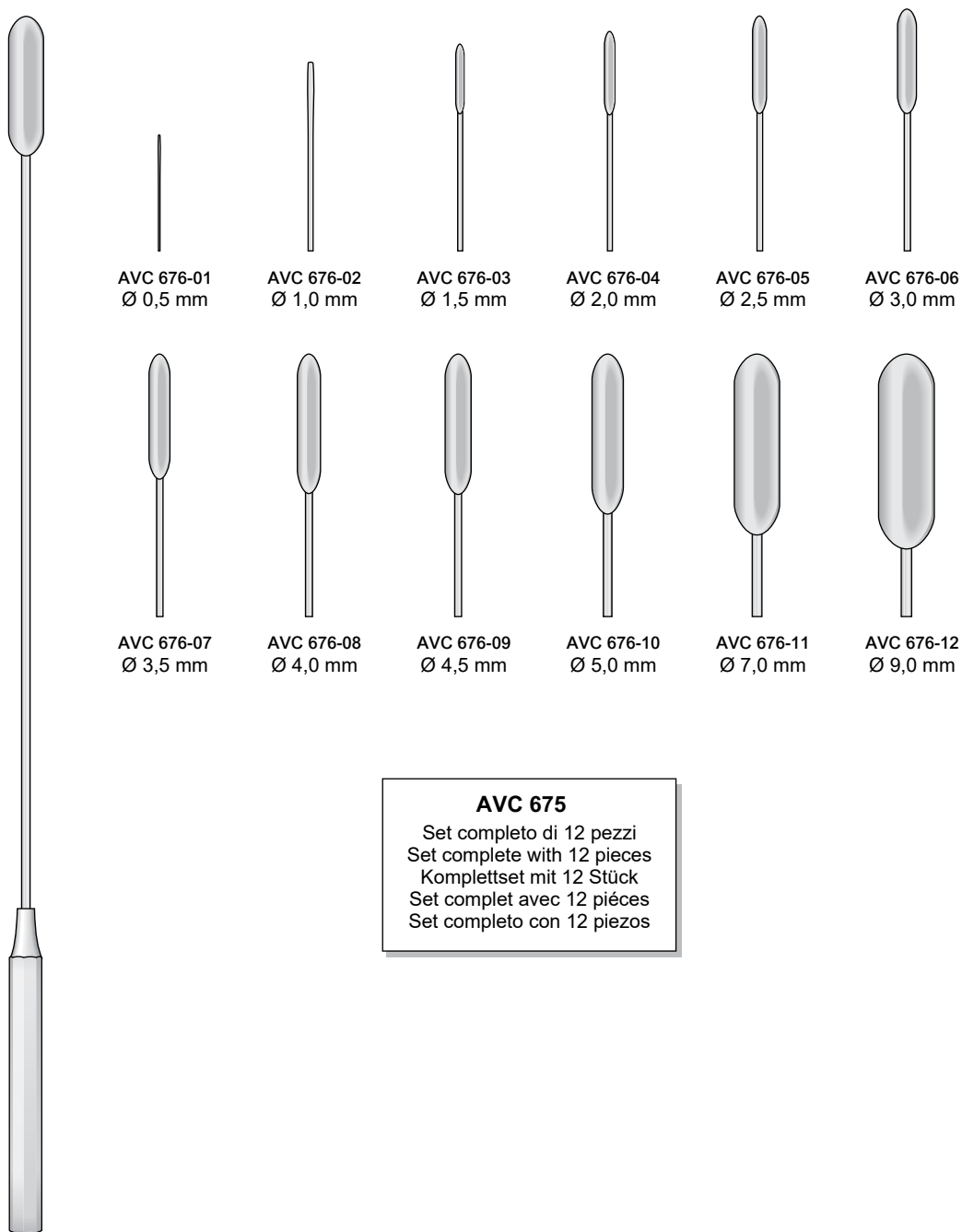

AVC 676-01
Ø 0,5 mm

AVC 676-02
Ø 1,0 mm

AVC 676-03
Ø 1,5 mm

AVC 676-04
Ø 2,0 mm

AVC 676-05
Ø 2,5 mm

AVC 676-06
Ø 3,0 mm

AVC 676-07
Ø 3,5 mm

AVC 676-08
Ø 4,0 mm

AVC 676-09
Ø 4,5 mm

AVC 676-10
Ø 5,0 mm

AVC 676-11
Ø 7,0 mm

AVC 676-12
Ø 9,0 mm

AVC 675

Set completo di 12 pezzi
Set complete with 12 pieces
Komplettset mit 12 Stück
Set complet avec 12 pièces
Set completo con 12 piezas

DE BAKEY

AVC 676-01 / AVC 676-12

19 cm

Code	Size
AVC 678-01	14 cm - Ø 1,0
AVC 678-02	14 cm - Ø 1,5
AVC 678-03	14 cm - Ø 2,0
AVC 678-04	14 cm - Ø 2,5
AVC 678-05	14 cm - Ø 3,0
AVC 678-06	14 cm - Ø 3,5
AVC 678-07	14 cm - Ø 4,0
AVC 678-08	14 cm - Ø 4,5
AVC 678-09	14 cm - Ø 5,0

Code	Size
AVC 678-10	21 cm - Ø 1,0
AVC 678-11	21 cm - Ø 1,5
AVC 678-12	21 cm - Ø 2,0
AVC 678-13	21 cm - Ø 2,5
AVC 678-14	21 cm - Ø 3,0
AVC 678-15	21 cm - Ø 3,5
AVC 678-16	21 cm - Ø 4,0
AVC 678-17	21 cm - Ø 4,5
AVC 678-18	21 cm - Ø 5,0

AVC 677

Set completo di 9 pezzi
 Set complete with 9 pieces
 Komplettsset mit 9 Stück
 Saet complet avec 9 pièces
 Set completo con 9 piezas

AVC 679

Set completo di 9 pezzi
 Set complete with 9 pieces
 Komplettsset mit 9 Stück
 Saet complet avec 9 pièces
 Set completo con 9 piezas

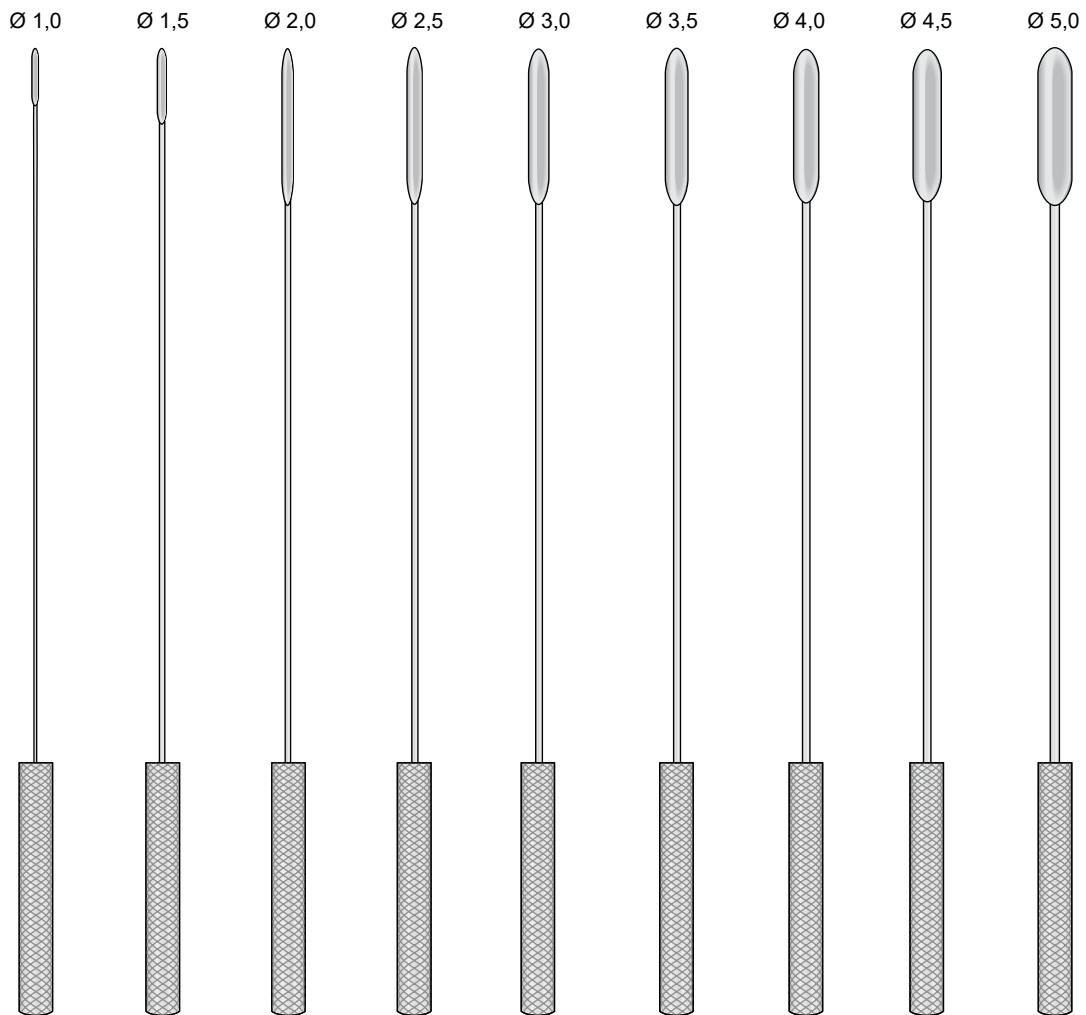

GARRETT
AVC 678-01 / AVC 678-18

Stripper anello tira vene
 Vein stripper
 Ringstripper
 Stripper à anneau
 Sonda para vârices

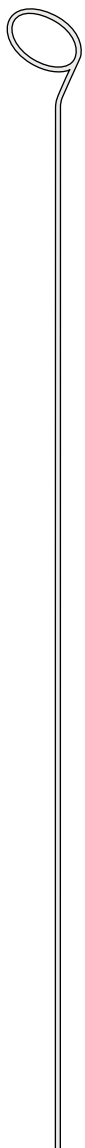

Ø 2 mm
 ○ 1/1
 AVC 680-01

Ø 3 mm
 ○ 1/1
 AVC 680-02

Ø 4 mm
 ○ 1/1
 AVC 680-03

Ø 6 mm
 ○ 1/1
 AVC 680-04

Ø 7 mm
 ○ 1/1
 AVC 680-05

Ø 8,5 mm
 ○ 1/1
 AVC 680-06

Ø 10 mm
 ○ 1/1
 AVC 680-07

Ø 12 mm
 ○ 1/1
 AVC 680-08

Ø 14 mm
 ○ 1/1
 AVC 680-09

VOLLMAR
AVC 680-01 / AVC 680-09
 50 cm



AVC 684-12
 12 cm

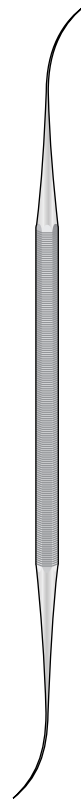

VARADY
AVC 681-18
 18 cm

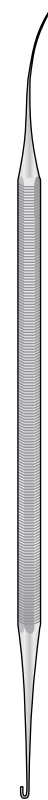

VARADY
AVC 682-18
 18 cm

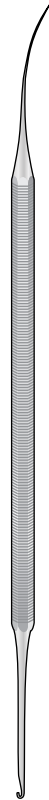

VARADY
AVC 683-18
 18 cm

Aghi vascolari malleabili - Gefäßspülkanülen
 Ø 3 mm Ø 4 mm Ø 5 mm Ø 6 mm



SCHMID
AVC 685-15
 15 cm



SCHMID
AVC 686-15
 15 cm



SCHMID
AVC 687-15
 15 cm



SCHMID
AVC 688-15
 15 cm

AP. 9-45 mm

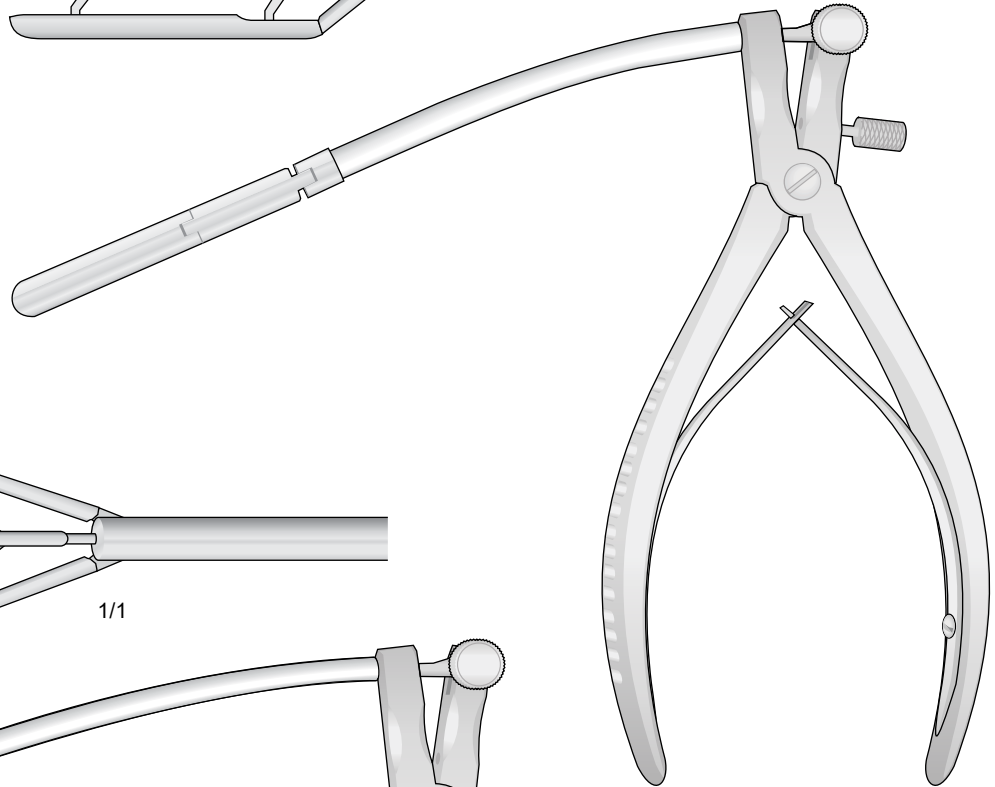
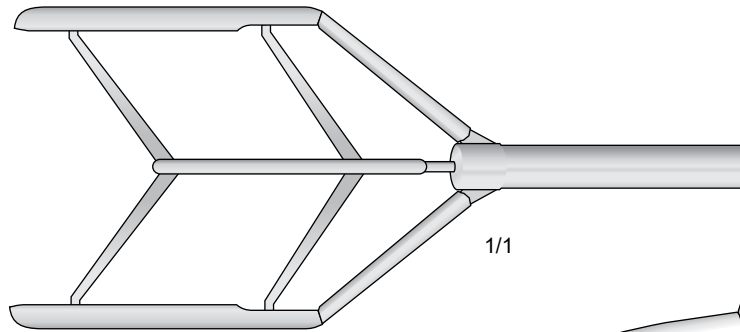

AP. 8-15 mm

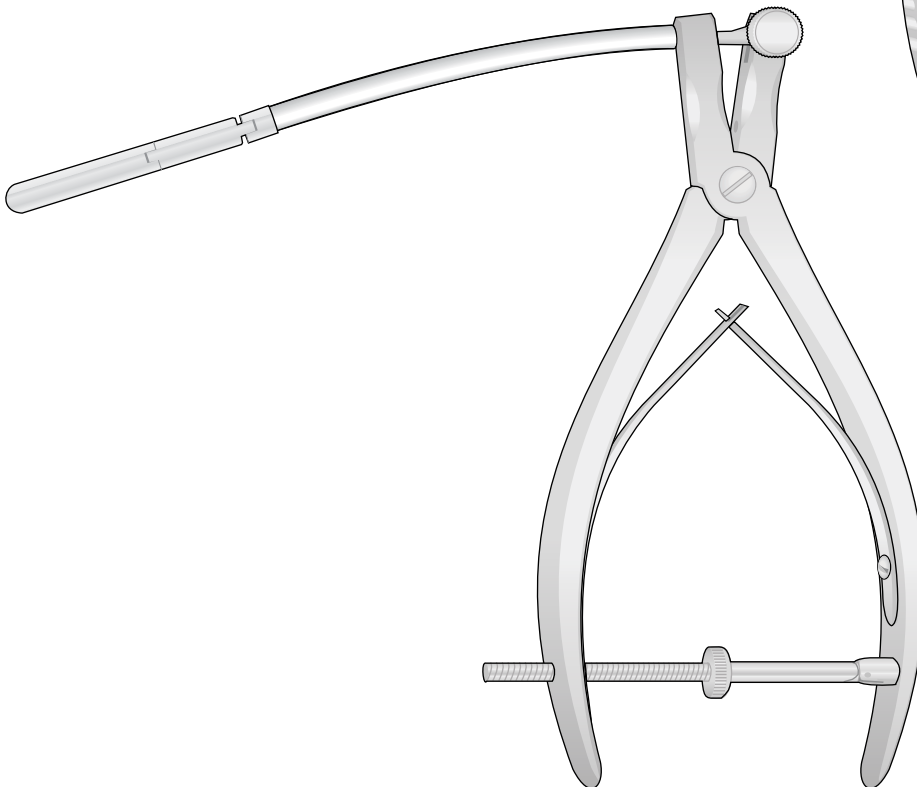
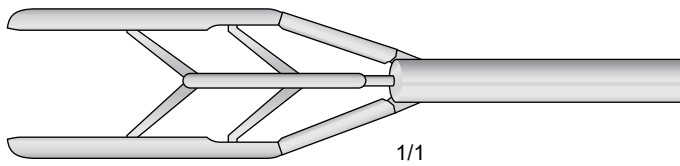



we take a closer look

Needle Holders Ligature Needles

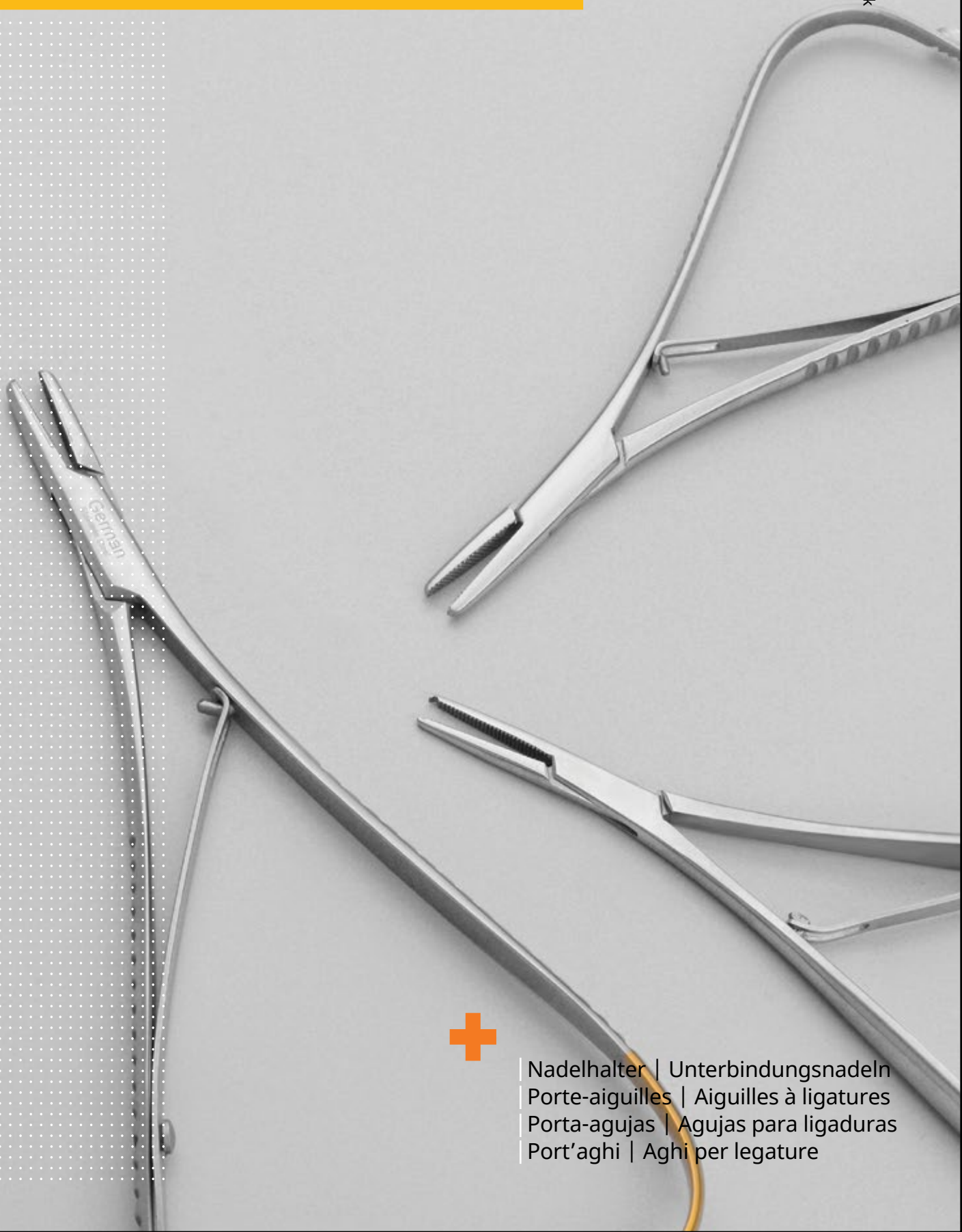

Nadelhalter | Unterbindungsnadeln
Porte-aiguilles | Aiguilles à ligatures
Porta-agujas | Agujas para ligaduras
Port'aghi | Aghi per legature

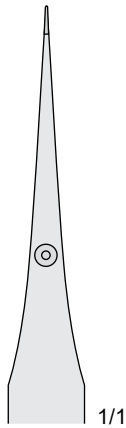
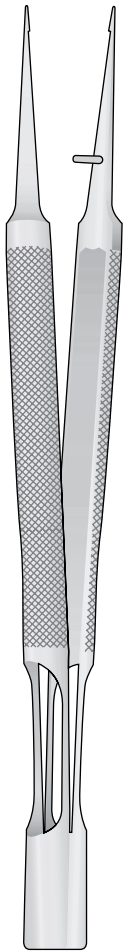
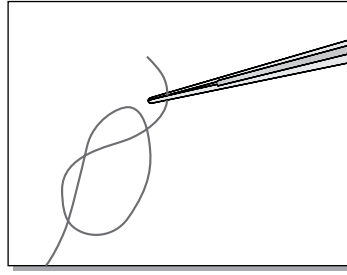

BROCK
MNH 700-13 13 cm

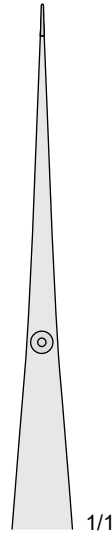
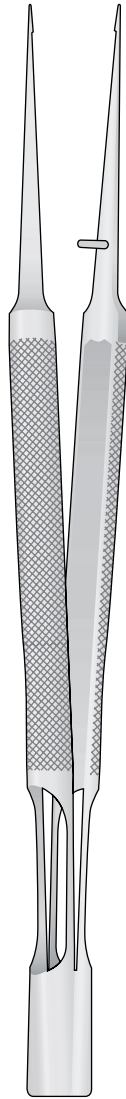

BROCK
MNH 701-15 15 cm

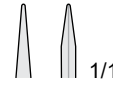
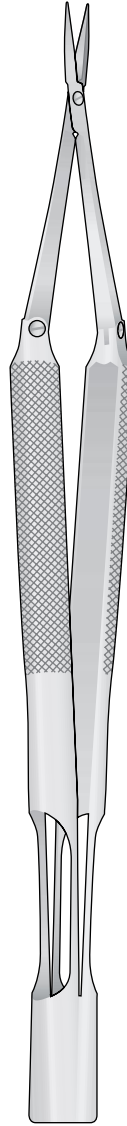

BROCK
MNH 702-15 15 cm

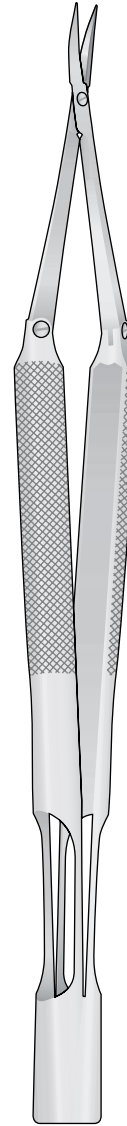

BROCK
MNH 703-15 15 cm

Micro port'agh
 Micro Needle Holder
 Micro Nadelhalte
 Micro porte aiguille
 Micro portaagujas

Con morso liscio
 Smooth jaws
 Glattes Maul
 A' mors lisses
 Mandibula lisa

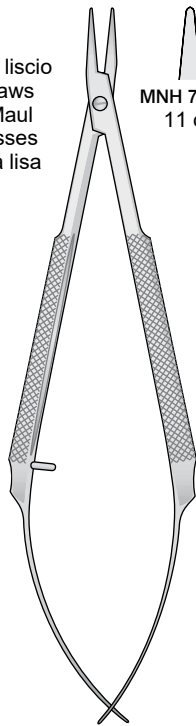

MNH 704-01
 1/1
 11 cm

MNH 704-02
 1/1
 11 cm

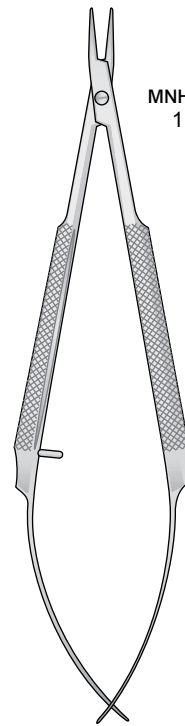

MNH 705-01
 1/1
 11 cm

MNH 705-02
 1/1
 11 cm

MNH 704-01 / MNH 704-02

MNH 705-01 / MNH 705-02

Con morso liscio
 Smooth jaws
 Glattes Maul
 A' mors lisses
 Mandibula lisa

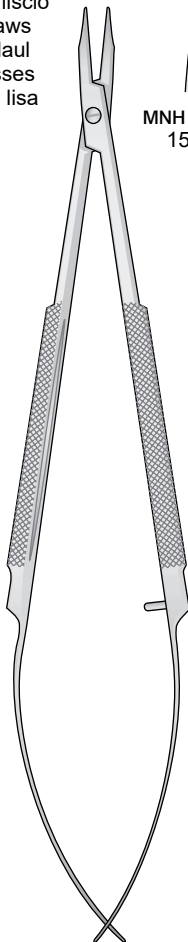

MNH 706-01
 1/1
 15 cm

MNH 706-02
 1/1
 15 cm

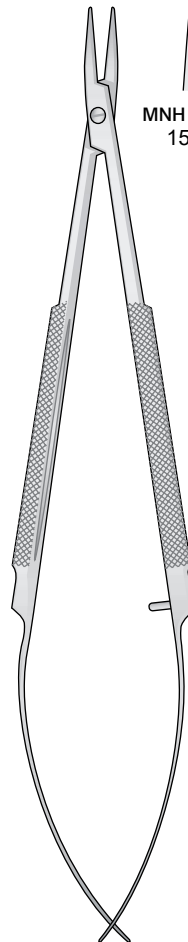

MNH 706-01
 1/1
 15 cm

MNH 706-02
 1/1
 15 cm

MNH 706-01 / MNH 706-02

MNH 707-01 / MNH 707-02

Con morso zigrinato fine
 Fine serrated jaws
 Feingerieftes Maul
 Mors stries fins
 Bocas estriadas finas

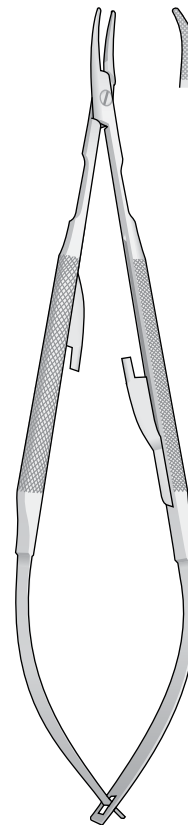

1/1

BARRAQUER

MNH 708-13 13.5 cm

Con morso liscio - Smooth jaws
Glattes Maul - A' mors lisses - Mandibula lisa

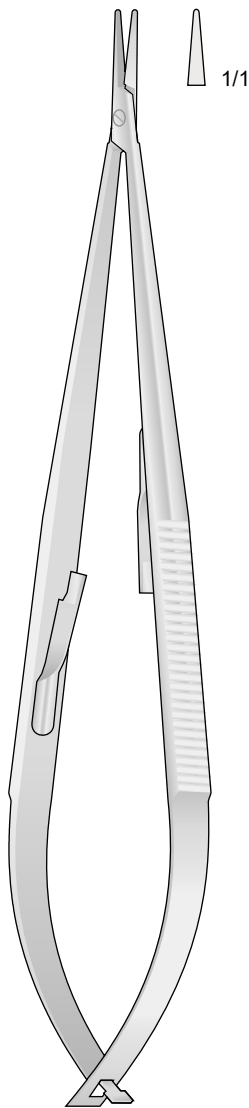

JACOBSON
MNH 709-18 18 cm

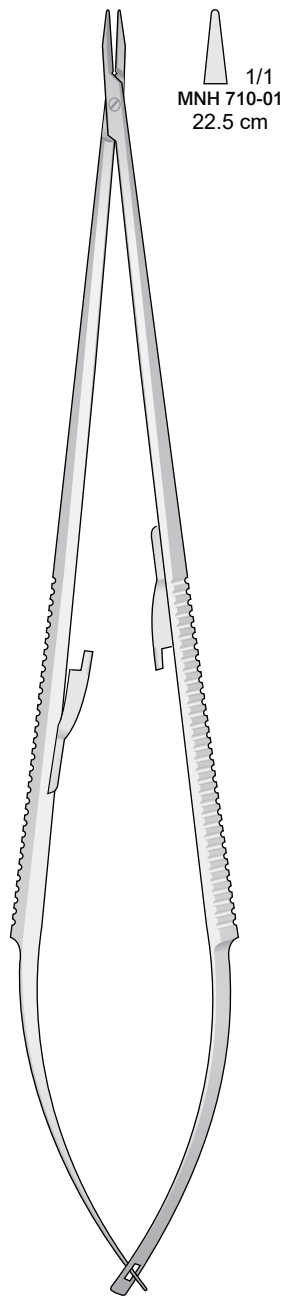

MNH 710-01 / MNH 710-02

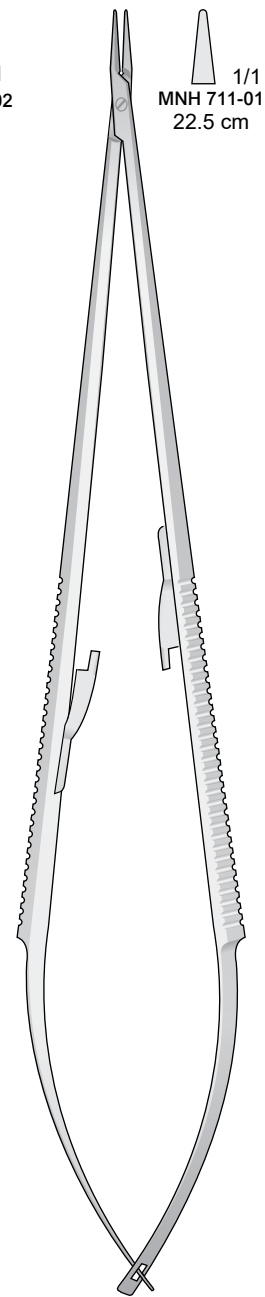

MNH 711-01 / MNH 711-02



Micro port'agh
Micro Needle Holder
Micro Nadelhalte
Micro porte aiguille
Micro portaagujas

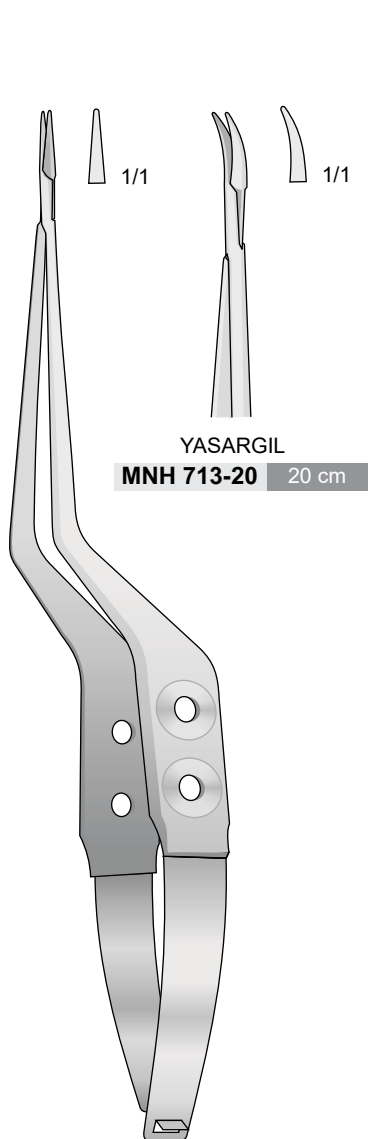

YASARGIL
MNH 712-20 20 cm

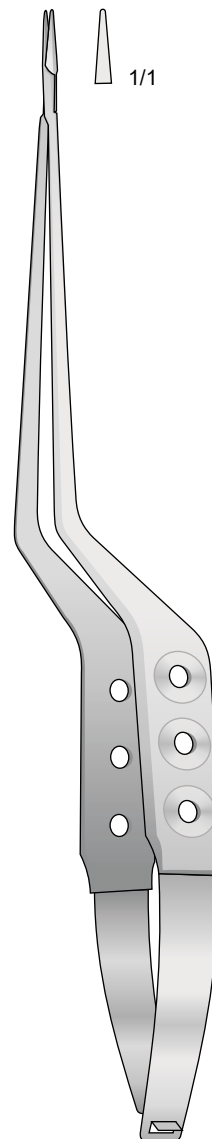

YASARGIL
MNH 714-22 22.5 cm

Portaghi con inserti al tungsteno
Needle Holders with tungsten-carbide inserts
Nadelhalter mit Hartmetalleinlagen
Porte aiguilles avec plaquettes en carbure de tungstène
Portaagujas con plaquitas de carburo de tungsteno

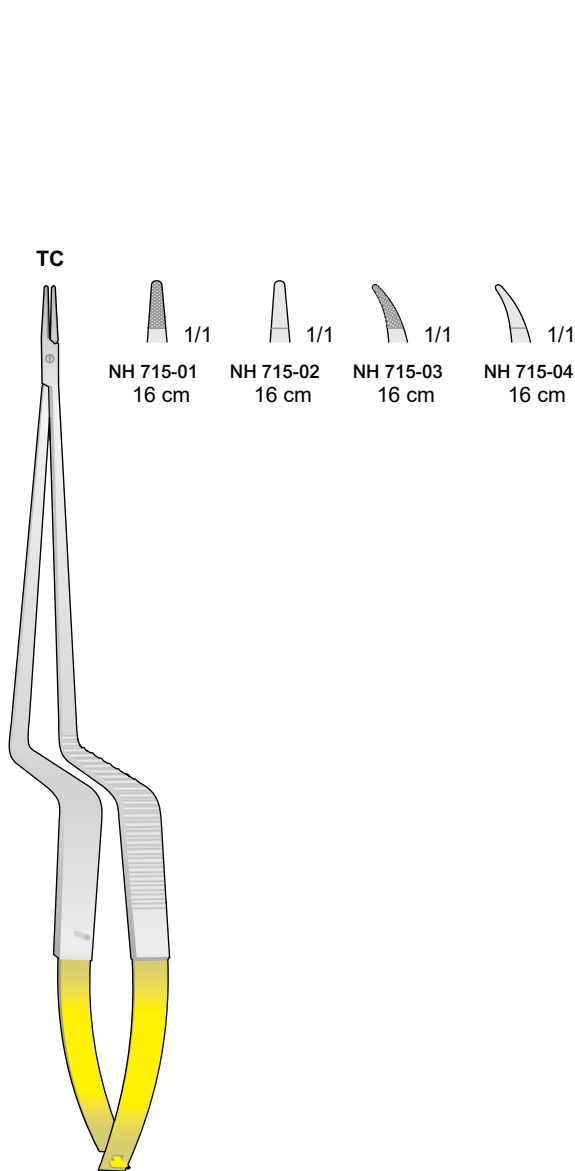

YASARGIL

NH 715-01 / NH 715-04

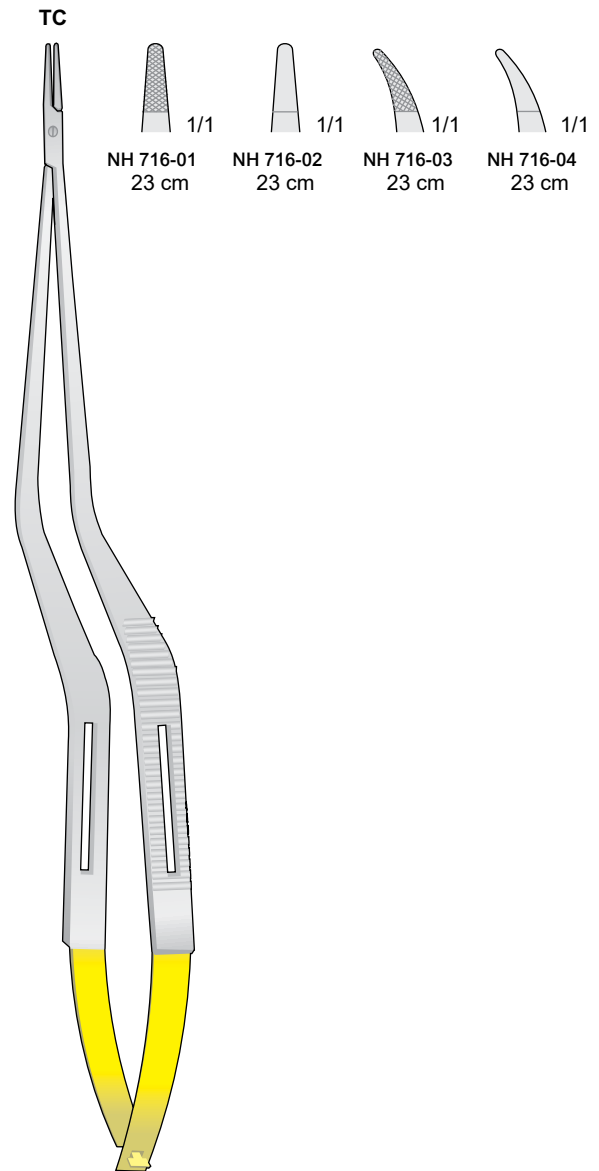

YASARGIL

NH 716-01 / NH 716-04

Port'aghi per micro chirurgia
 Micro Needle Holder
 Micro Nadelhalter
 Micro Porte aiguilles
 Micro portaagujas

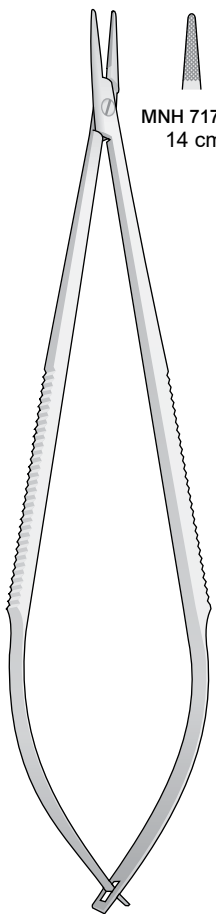

MNH 717-01 1/1
 14 cm MNH 717-02 1/1
 14 cm

MNH 717-01 / NNH 717-02

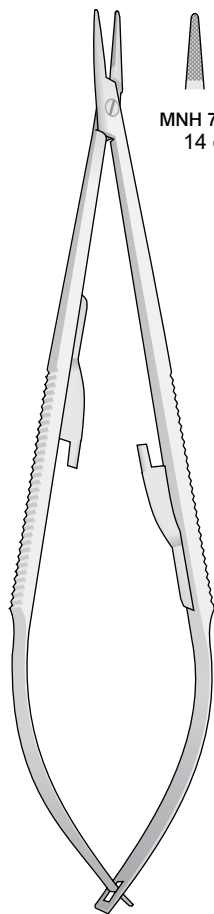

MNH 718-01 1/1
 14 cm MNH 718-02 1/1
 14 cm

CASTROVIEJO
MNH 718-01 / NNH 718-02

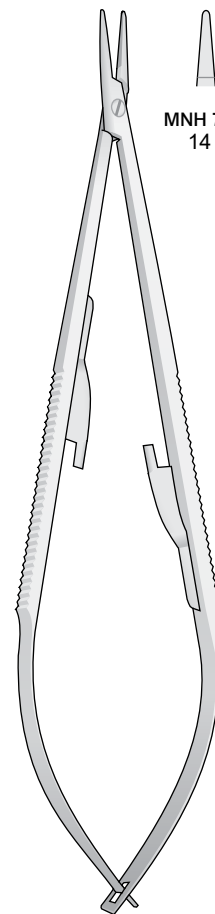

Con morso liscio
 With smooth jaws
 Mit Glatten maul
 Avec mors lisses
 Con mandibula lisa

MNH 719-01 1/1
 14 cm MNH 719-02 1/1
 14 cm

CASTROVIEJO
MNH 719-01 / NNH 719-02

Portaghi con inserti al tungsteno
Needle Holders with tungsten-carbide inserts
Nadelhalter mit Hartmetalleinlagen
Porte aiguilles avec plaquettes en carbure de tungstène
Portaagujas con plaquitas de carburo de tungsteno

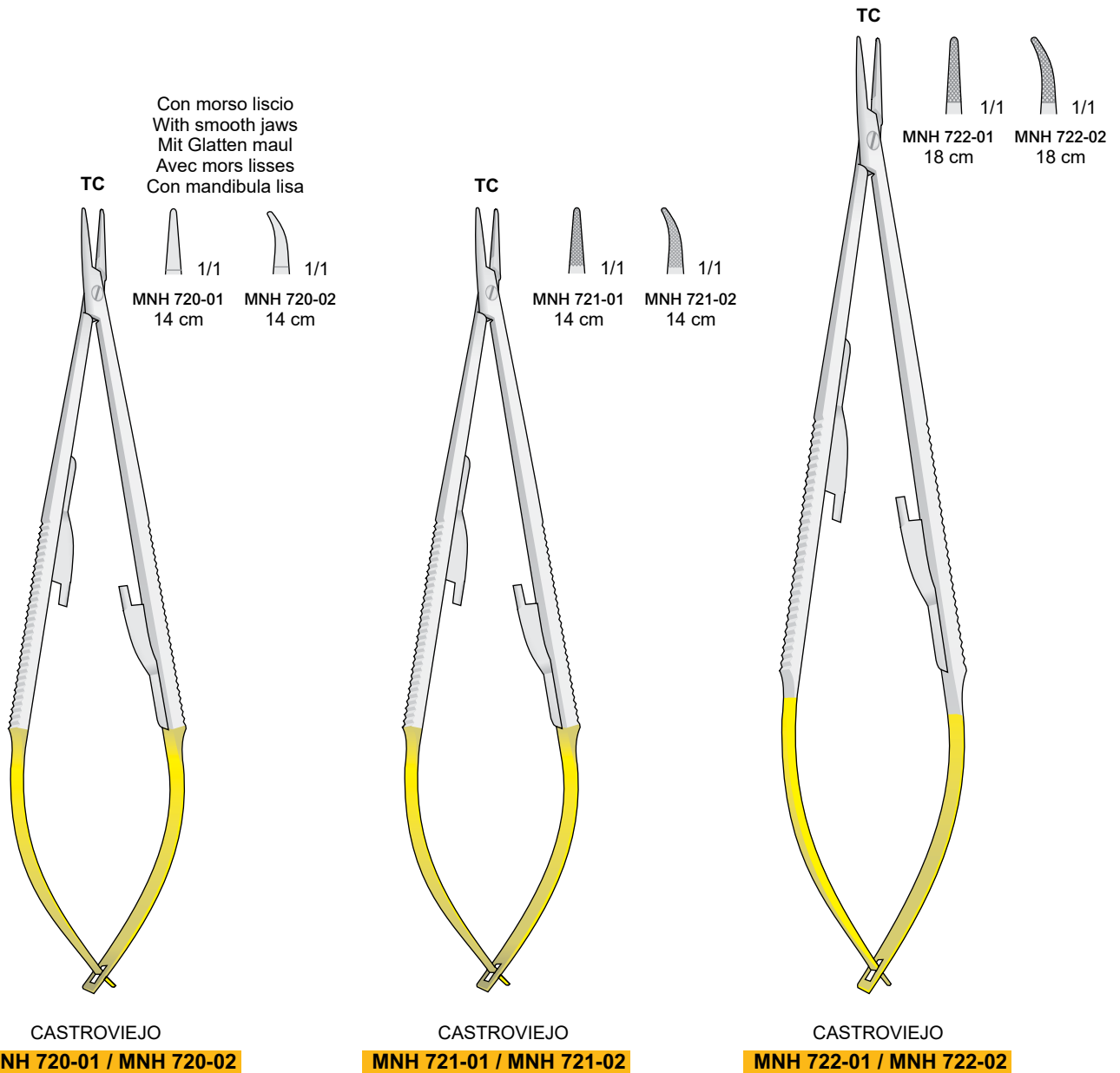

Portaghi con inserti al tungsteno
 Needle Holders with tungsten-carbide inserts
 Nadelhalter mit Hartmetalleinlagen
 Porte aiguilles avec plaquettes en carbure de tungstène
 Portaagujas con plaquitas de carburo de tungsteno

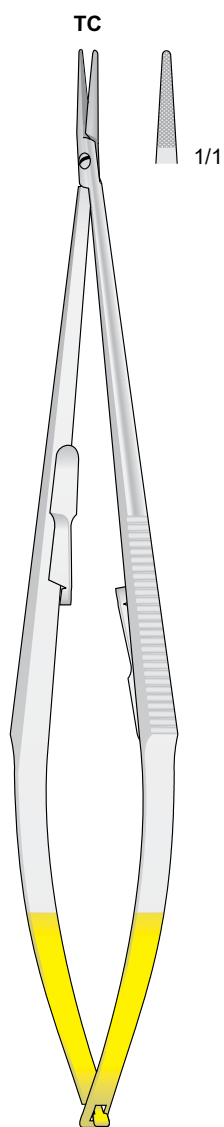

CASTROVIEJO
 NH 723-21 21.5 cm

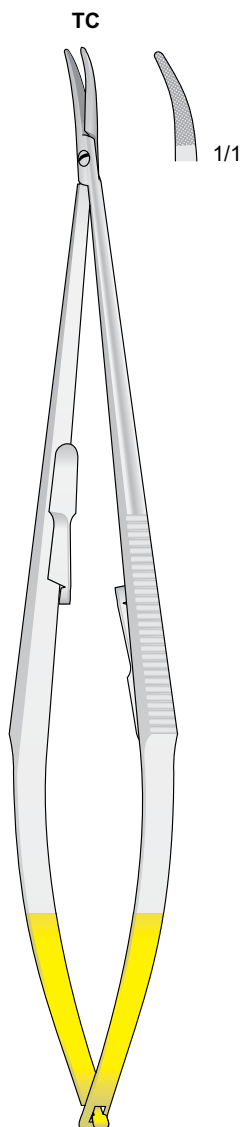

CASTROVIEJO
 NH 724-21 21.5 cm

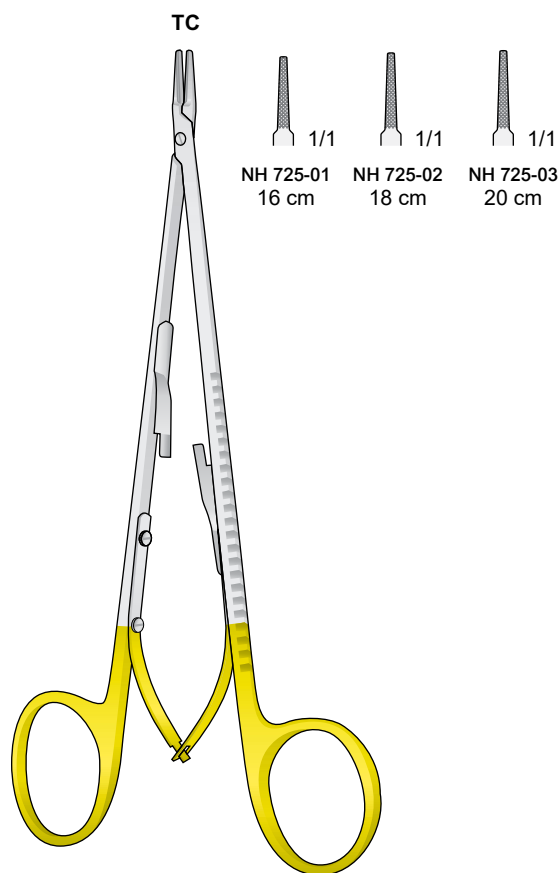

DIETRICH
 NH 725-01 / NH 725-02

Con morso liscio
With smooth jaws
Mit Glatten mau
Avec mors lisses
Con mandibula lisa

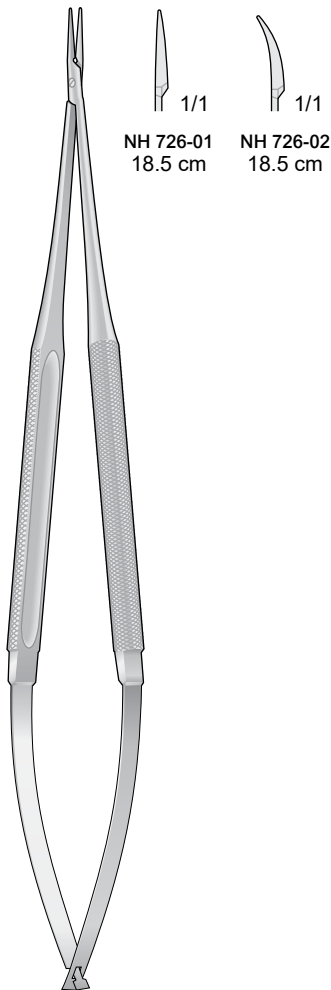

NH 726-01
18.5 cm

NH 726-02
18.5 cm

NH 726-01 / NH 726-02

Con morso liscio
With smooth jaws
Mit Glatten mau
Avec mors lisses
Con mandibula lisa

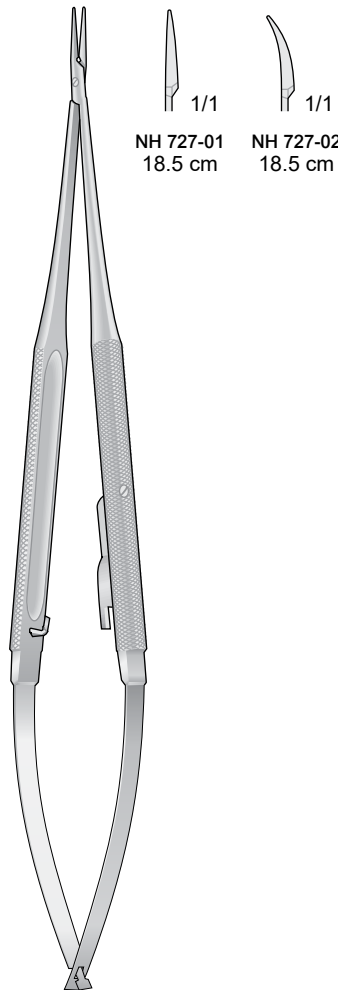

NH 727-01
18.5 cm

NH 727-02
18.5 cm

NH 727-01 / NH 727-02

Portaghi con inserti al tungsteno
Needle Holders with tungsten-carbide inserts
Nadelhalter mit Hartmetalleinlagen
Porte aiguilles avec plaquettes en carbure de tungstène
Portaagujas con plaquitas de carburo de tungsteno

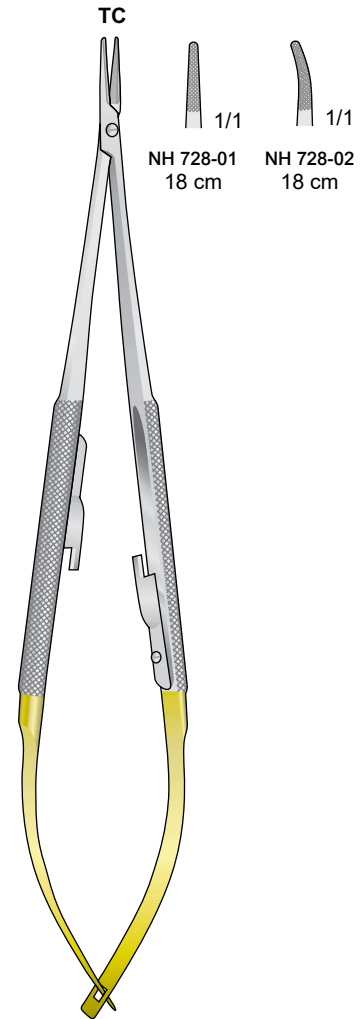

NH 728-01
18 cm

NH 728-02
18 cm

JACOBSON

NH 728-01 / NH 728-02

Portaghi con inserti al tungsteno
 Needle Holders with tungsten-carbide inserts
 Nadelhalter mit Hartmetalleinlagen
 Porte aiguilles avec plaquettes en carbure de tungstène
 Portaagujas con plaquitas de carburo de tungsteno

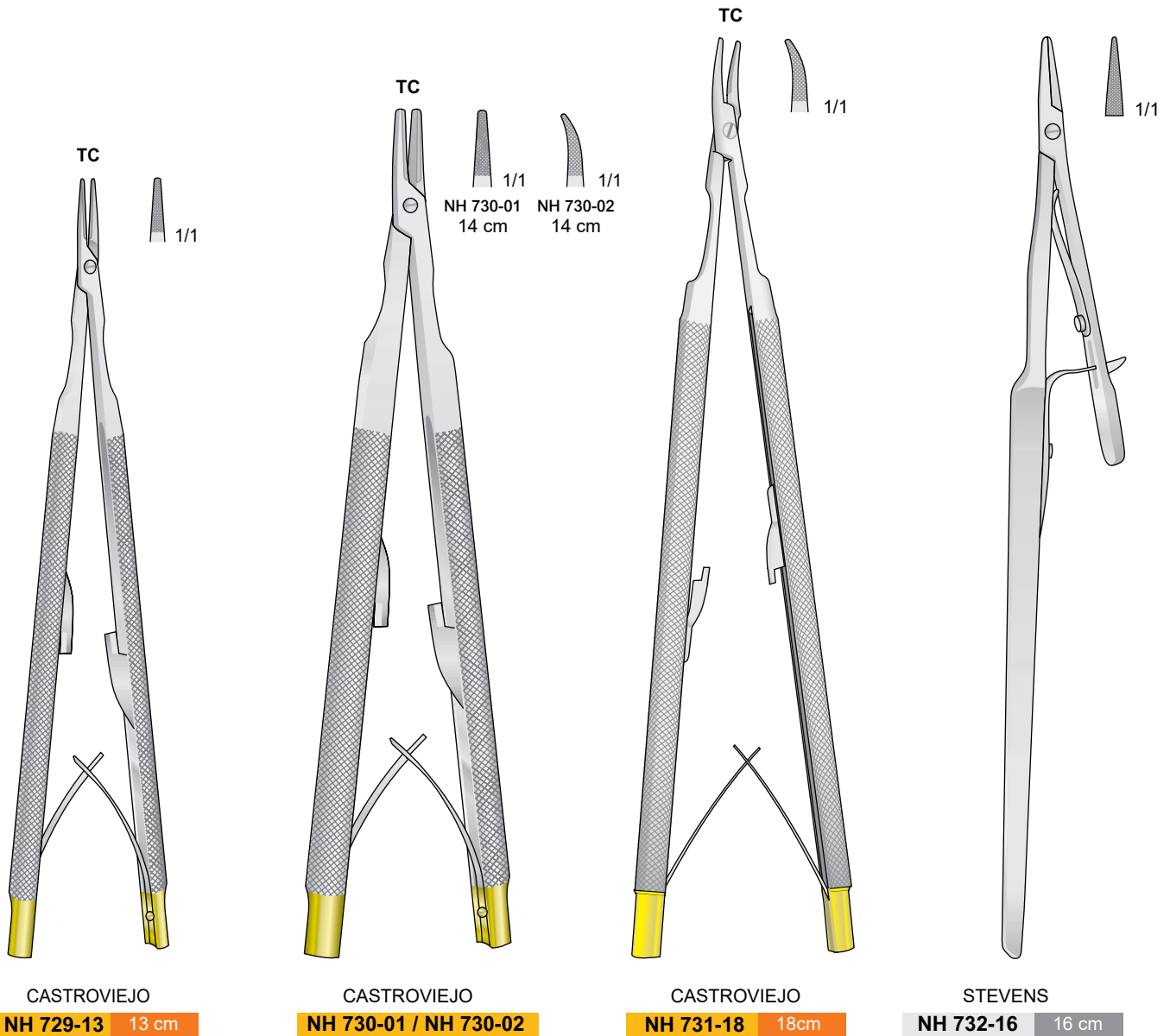

Con morso liscio
With smooth jaws
Mit Glatten mau
Avec mors lisses
Con mandibula lisa

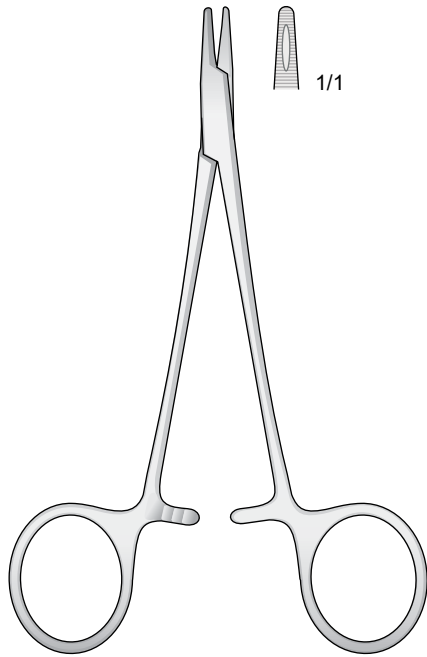

DERF

NH 733-12 12.5 cm

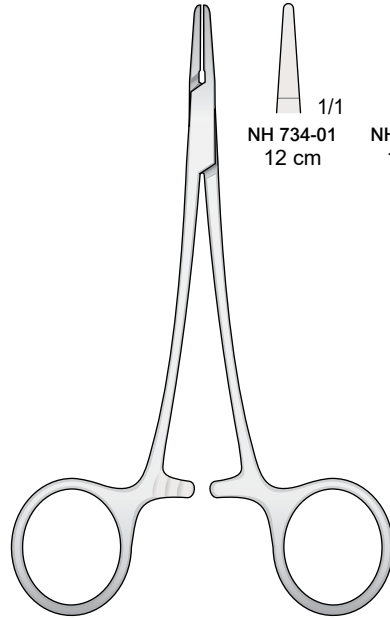

NH 734-01
12 cm

NH 734-02
12 cm

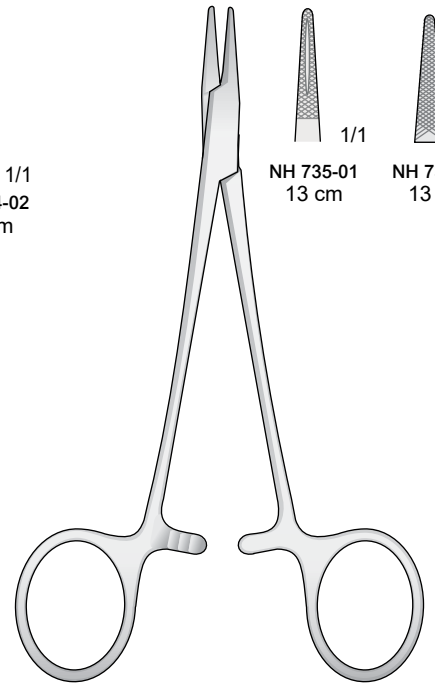

NH 735-01
13 cm

NH 735-02
13 cm

HALSEY

NH 735-01 / NH 735-02

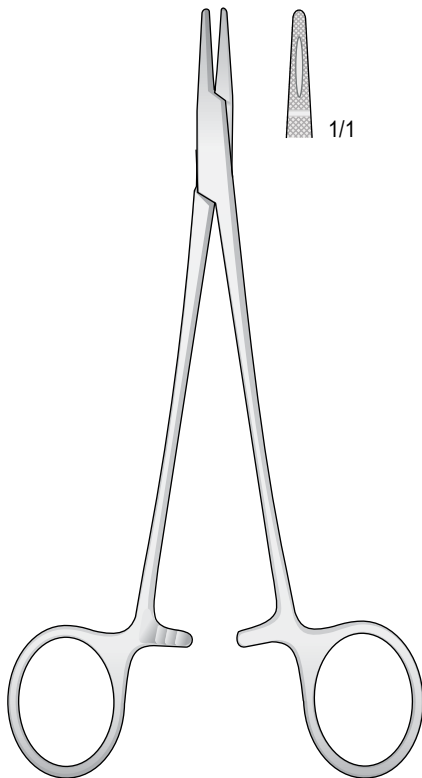

CRILE-WOOD

NH 736-15 15 cm

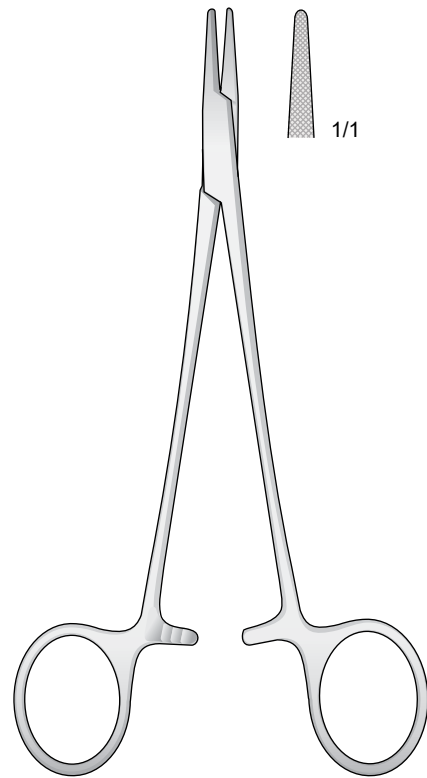

CRILE-MURRAY

NH 737-15 15 cm

Modello fine - Delicate pattern - Schlanke Modell
 Modèle fin - Modelo delegado

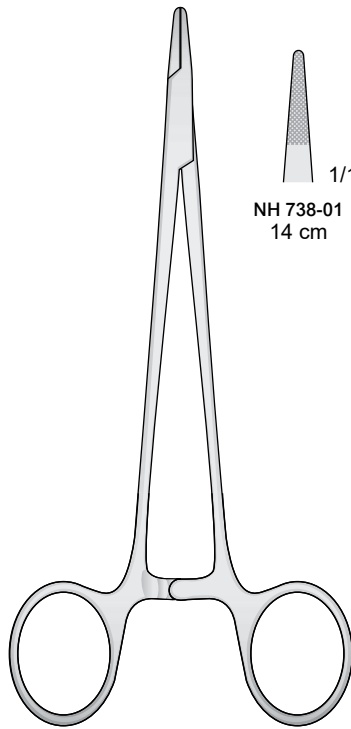

MAYO-HEGAR
NH 738-01 / NH 738-06

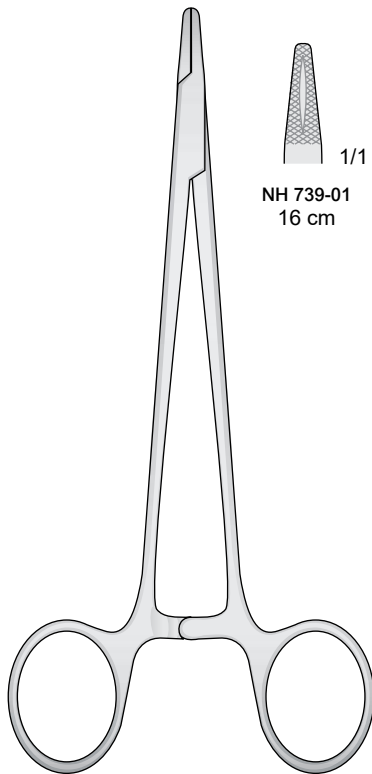
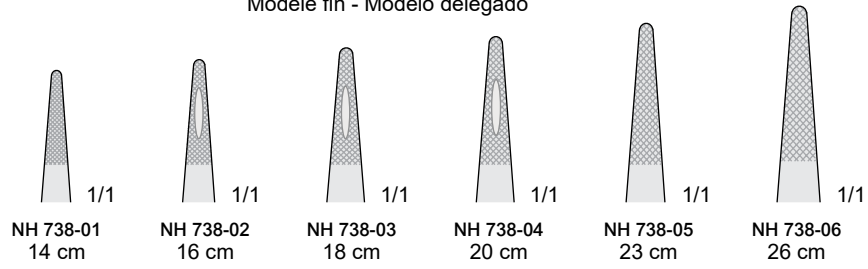

HEGAR
NH 739-01 / NH 739-03

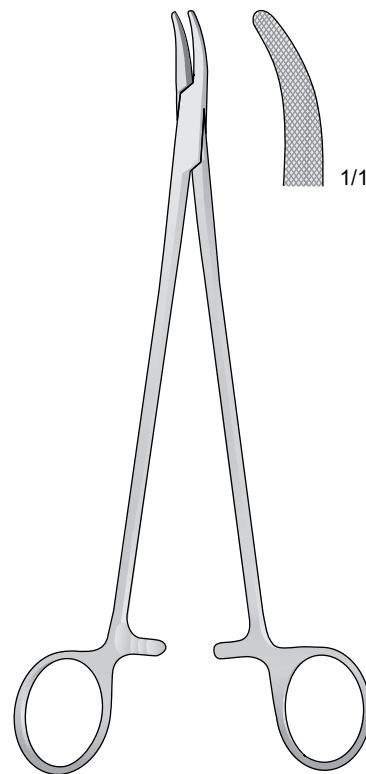
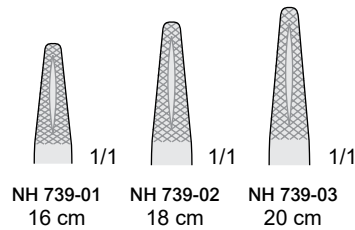

HEANEY (HEGAR)
NH 740-20 20 cm

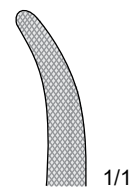

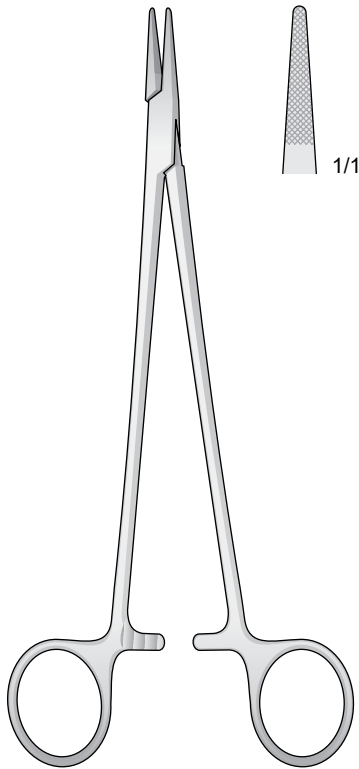

HEGAR-MAYO-SEELEY
NH 741-20 20 cm

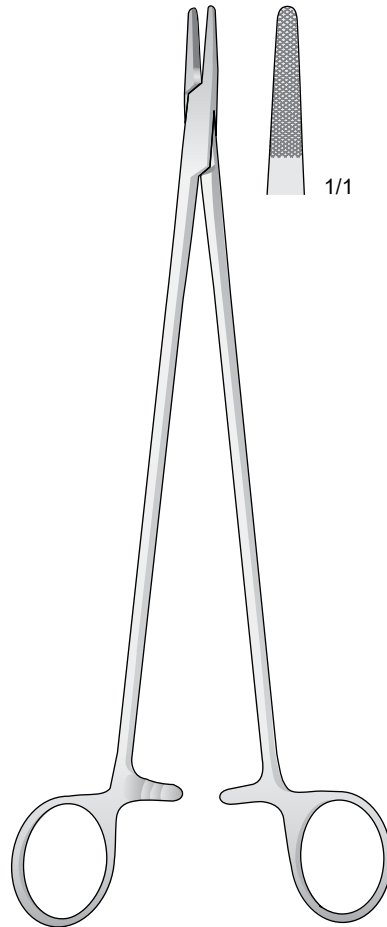

MASSON
NH 742-27 27 cm

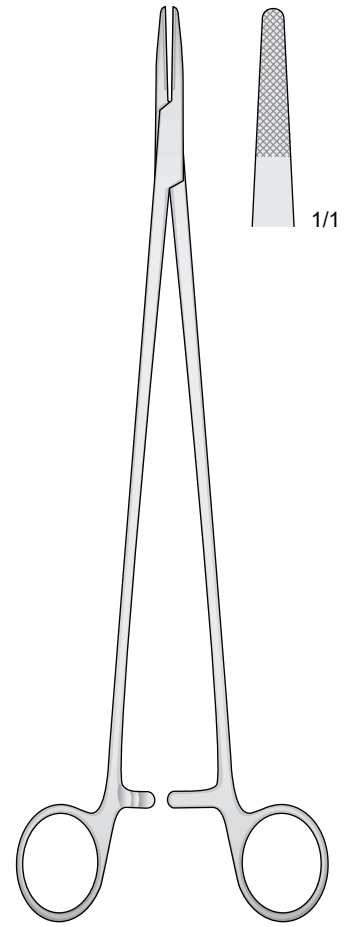

WANGENSTEEN
NH 743-27 27 cm

Port'aghi con forbici - Needle holders with scissors - Nadelhalter mit Schere - Porte aiguilles avec ciseaux - Portaagujas con tijeras

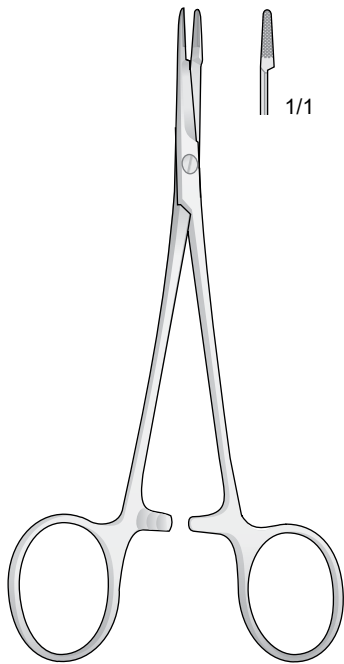

MINI-OLSEN-HEGAR
NH 744-12 12 cm

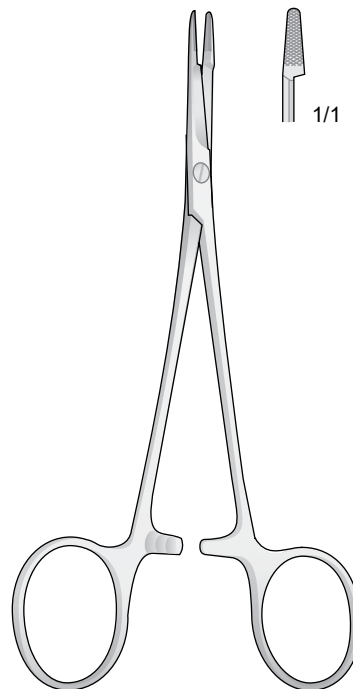

OLSEN-HEGAR
NH 745-14 14 cm

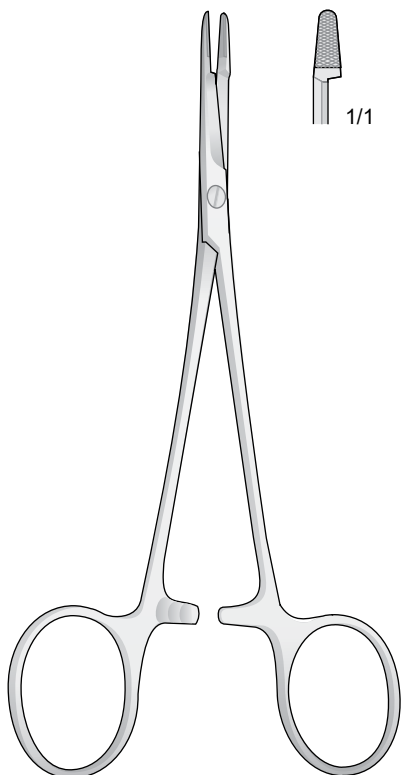

OLSEN-HEGAR
NH 746-17 17 cm

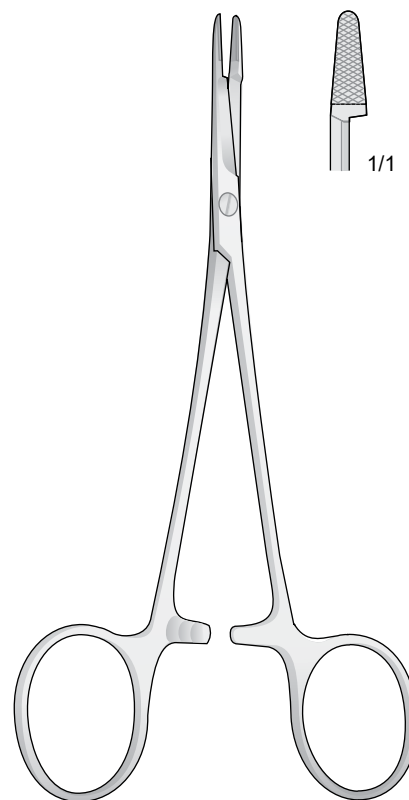

OLSEN-HEGAR
NH 747-19 19 cm

Port'aghi con forbici - Needle holders with scissors - Nadelhalter mit Schere - Porte aiguilles avec ciseaux - Portaagujas con tijeras

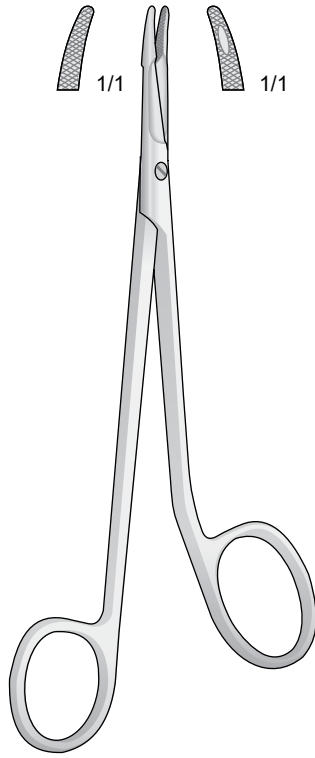

MINI-GILLIES

NH 748-14 14.5 cm

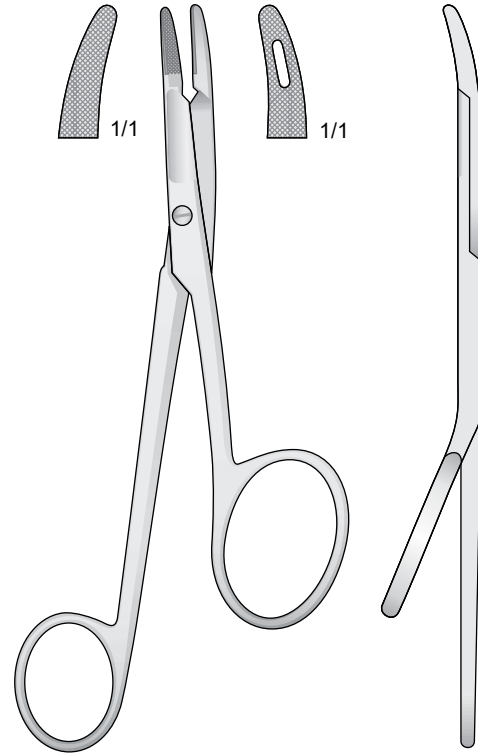

GILLIES

NH 749-16 16 cm

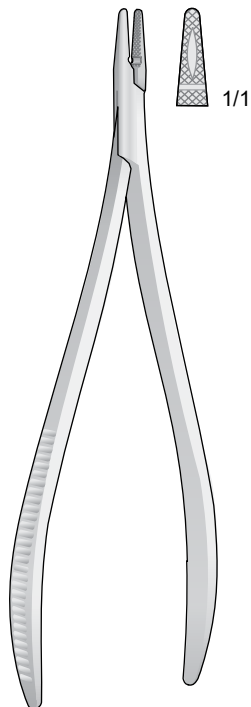

CRILE

NH 750-15 15 cm

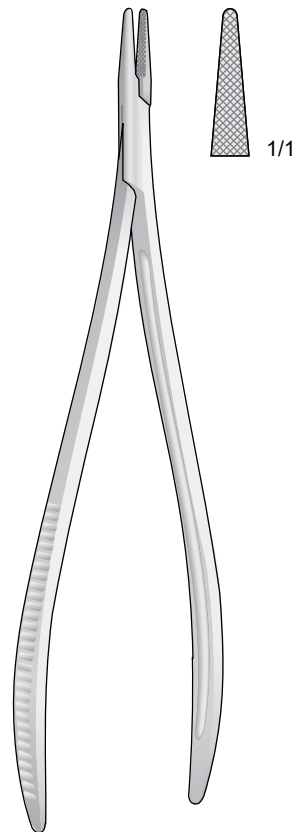

TÖNNIS

NH 751-19 19 cm

Port'aghi
Needle Holders
Nadelhalter
Nadelhalter
Portaagujas

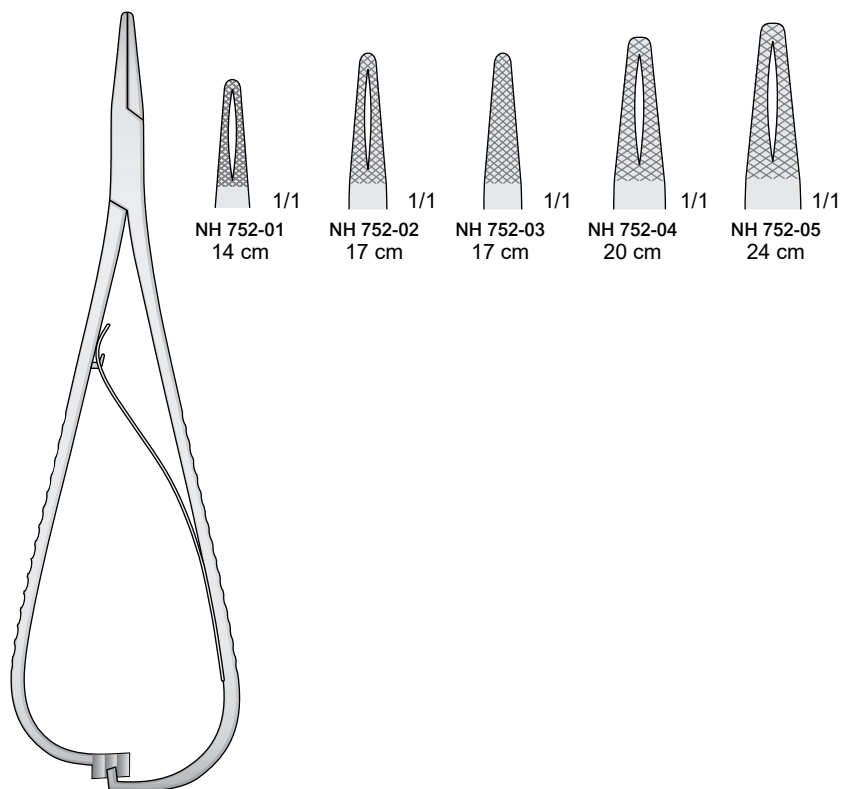

MATHIEU

NH 752-01 / NH 752-05

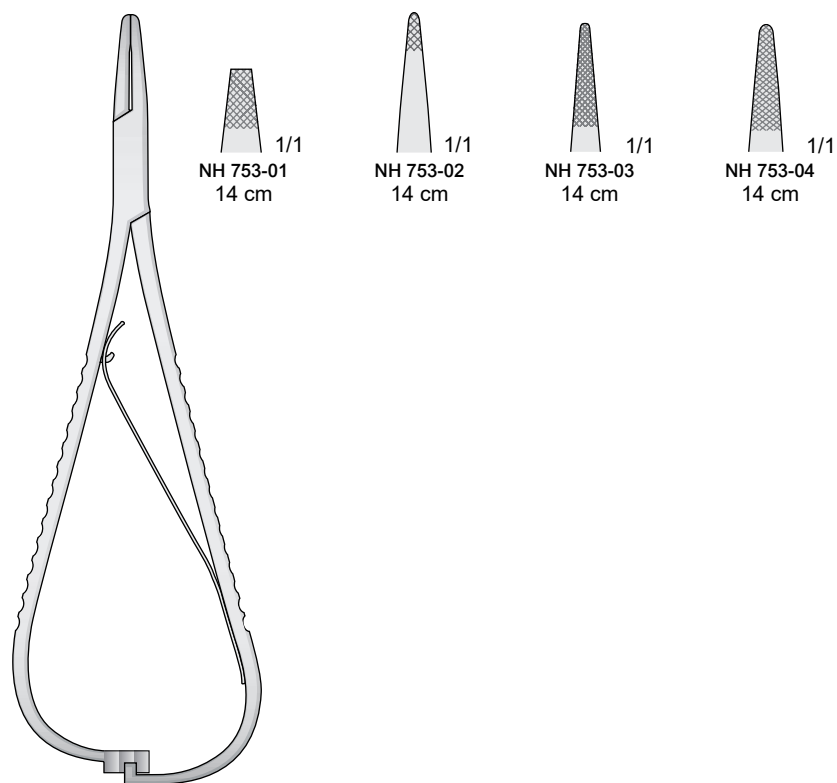

MATHIEU

NH 753-01 / NH 753-04



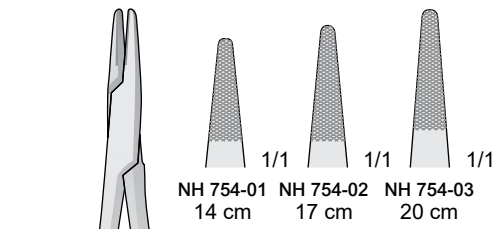

MATHIEU

NH 754-01 / NH 754-03

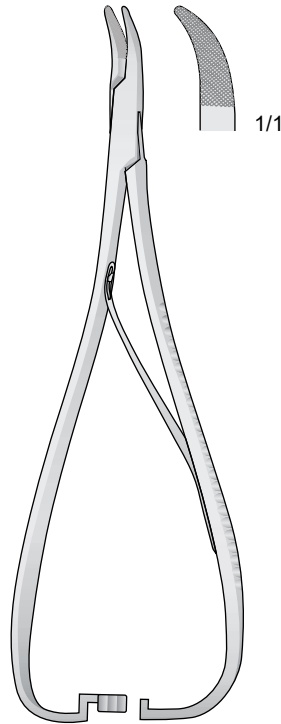

NH 755-14 14 cm

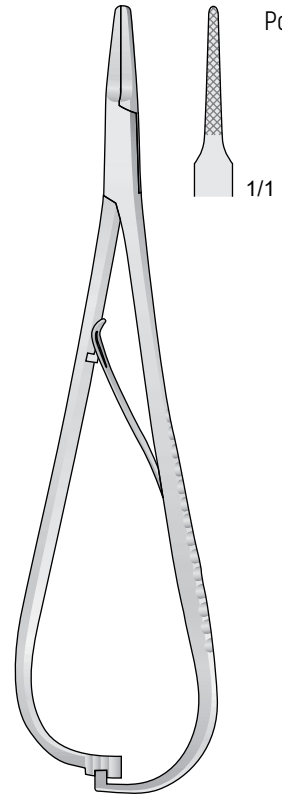

STILLE

NH 756-17 17 cm

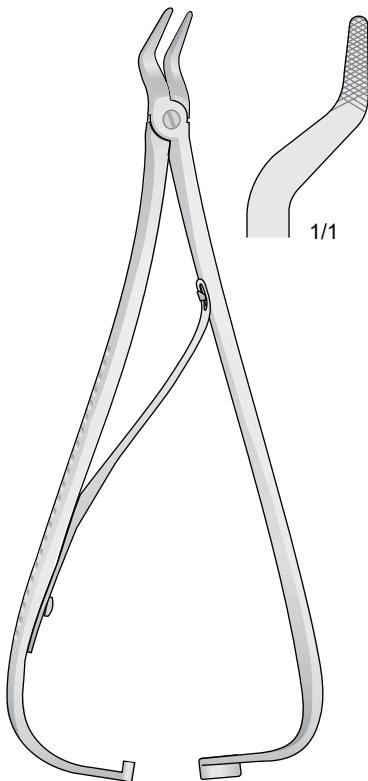

EISELBERG-MATHIEU

NH 757-18 18 cm

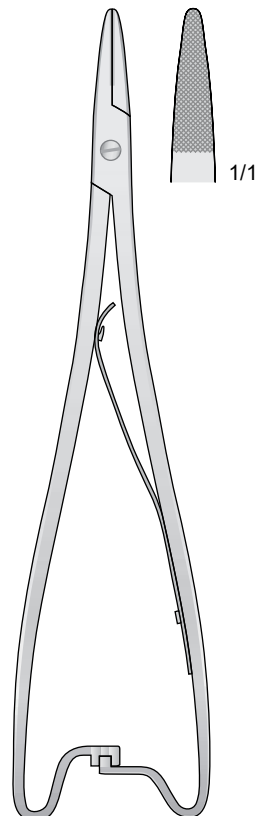

MATHIEU

NH 758-20 20 cm

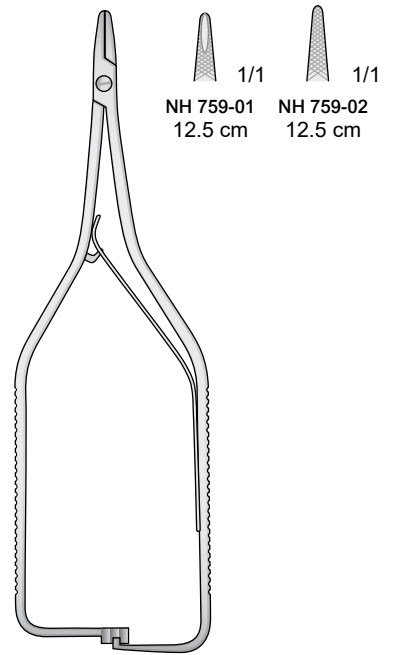

BOYNTON

NH 759-01 / NH 759-02

Portaghi con inserti al tungsteno - Needle Holders with tungsten-carbide inserts
 Nadelhalter mit Hartmetalleinlagen - Porte aiguilles avec plaquettes en carbure de tungstène
 Portaagujas con plaquitas de carburo de tungsteno

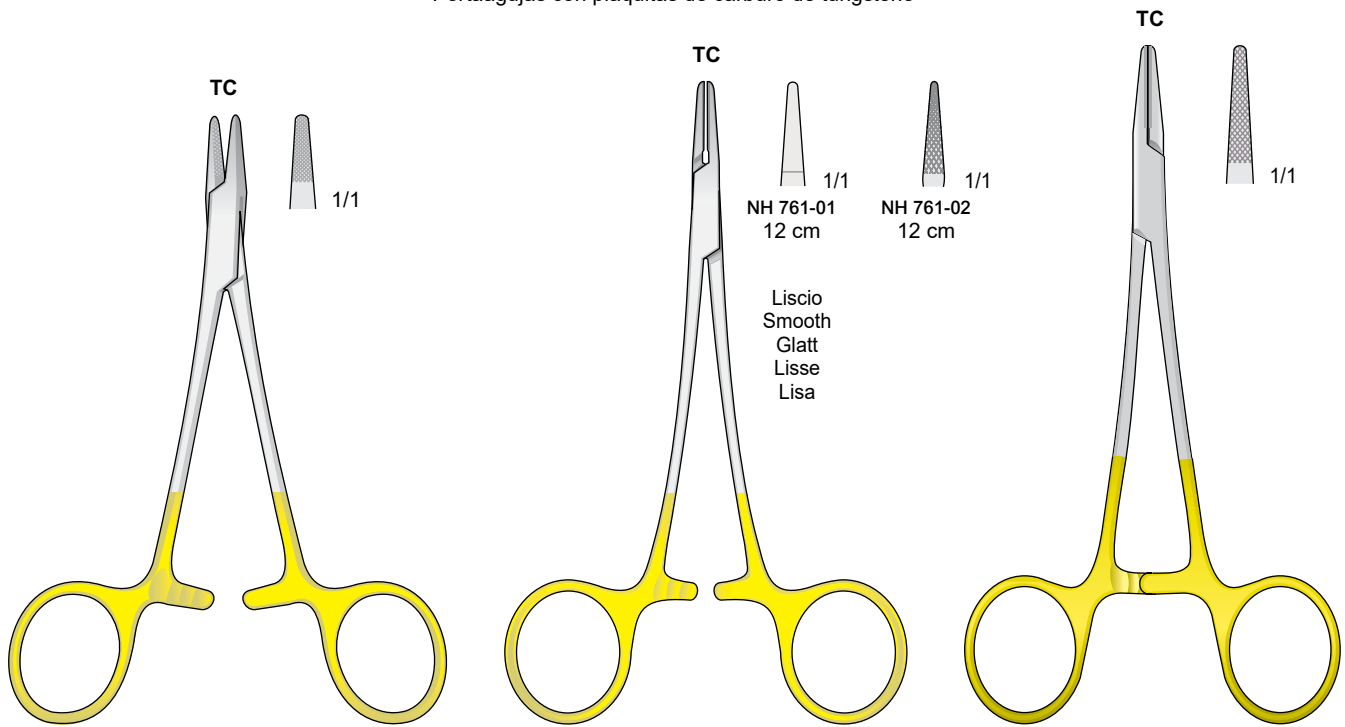

DERF
NH 760-15 11.5 cm

NH 761-01 / NH 761-02

CONVERSE
NH 762-13 13 cm

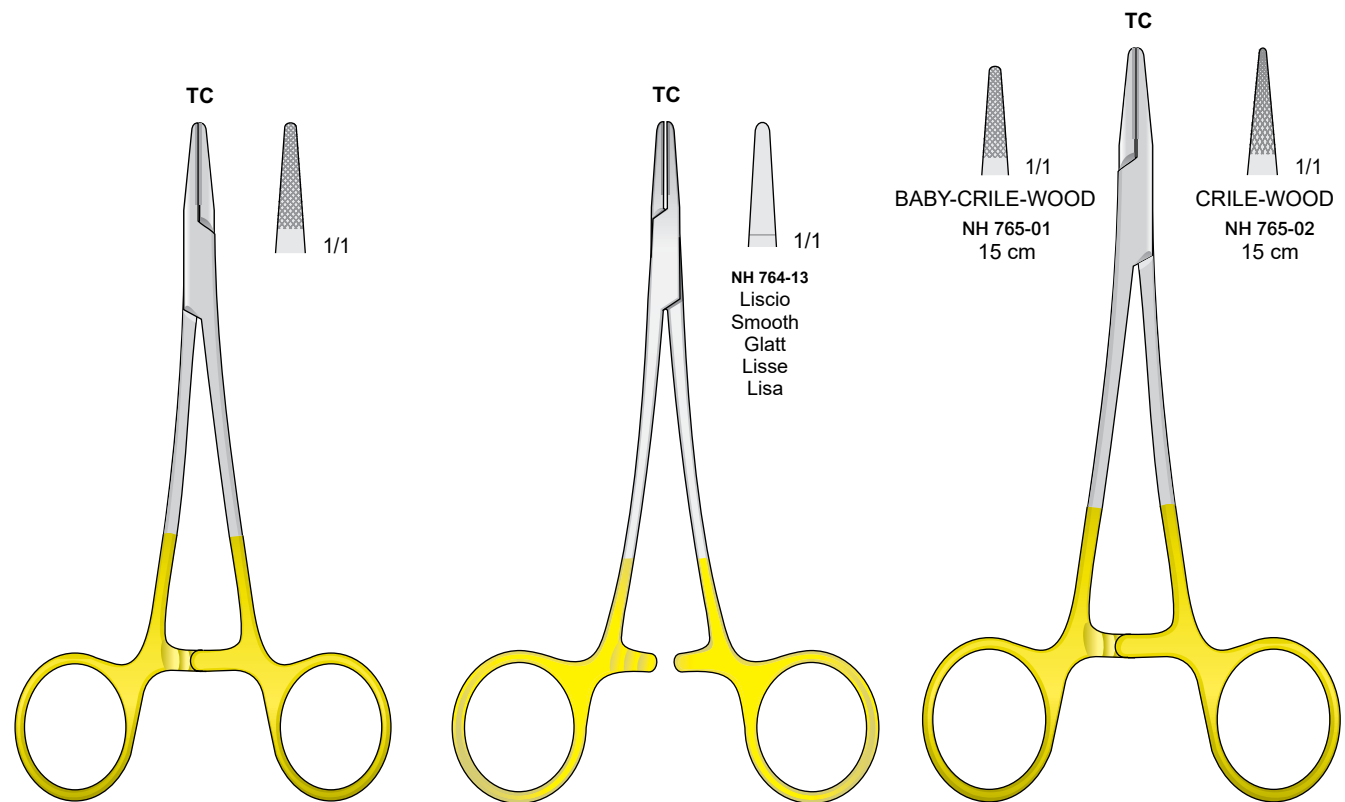

HALSEY
NH 763-13 13 cm

WEBSTER
NH 764-13 13 cm

CRILE-WOOD
NH 765-01 / NH 765-02

Portaghi con inserti al tungsteno - Needle Holders with tungsten-carbide inserts
Nadelhalter mit Hartmetalleinlagen - Porte aiguilles avec plaquettes en carbure de tungstène
Portaagujas con plaquitas de carburo de tungsteno

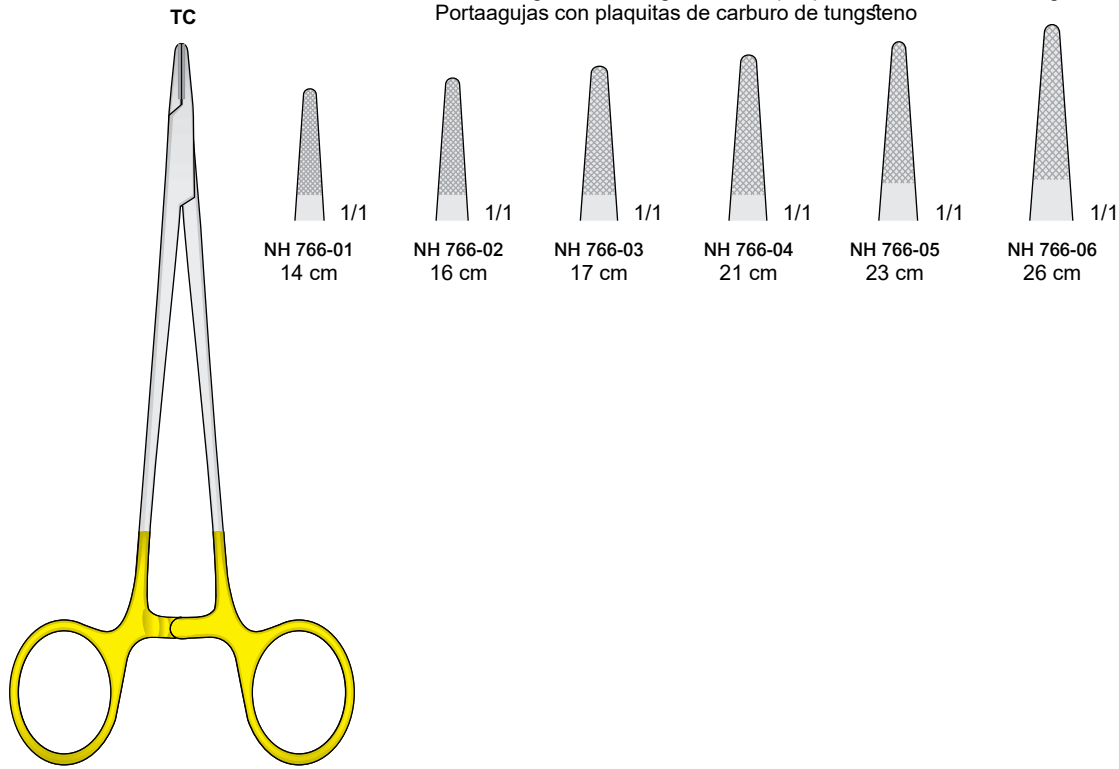

MAYO-HEGAR

NH 766-01 / NH 766-06

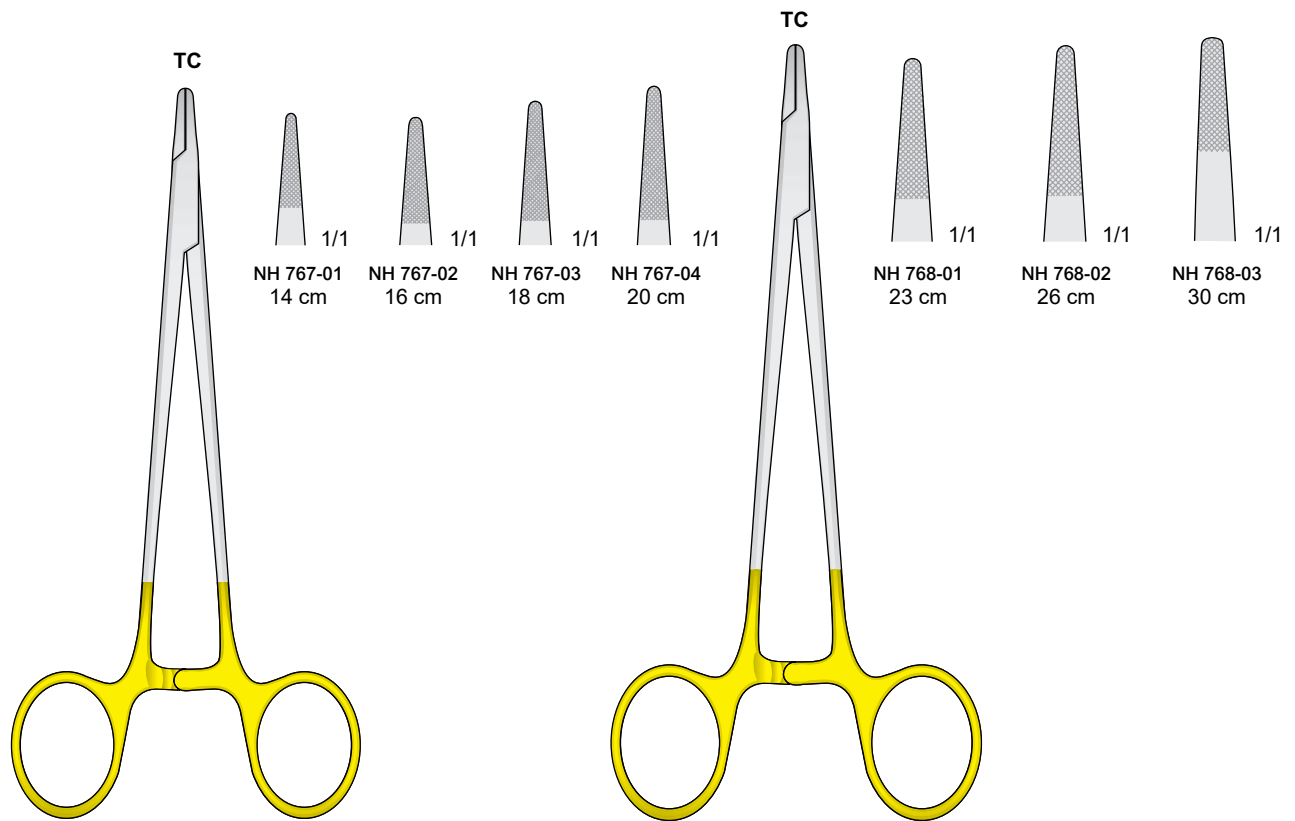

HEGAR

NH 767-01 / NH 767-04

MAYO-HEGAR

NH 768-01 / NH 768-03

Port'aghi
 Needle Holders
 Nadelhalter
 Nadelhalter
 Portaagujas

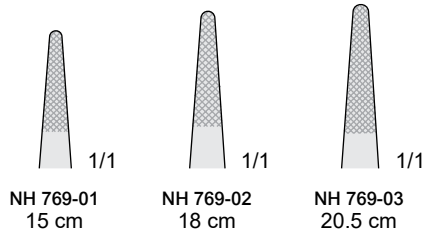
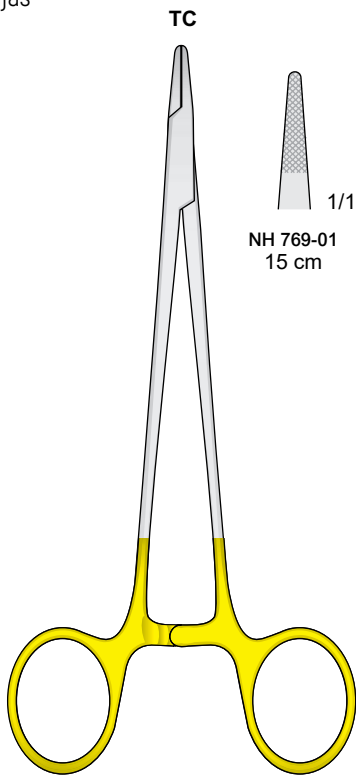

MAYO-HEGAR-FINO
NH 769-01 / NH 769-03

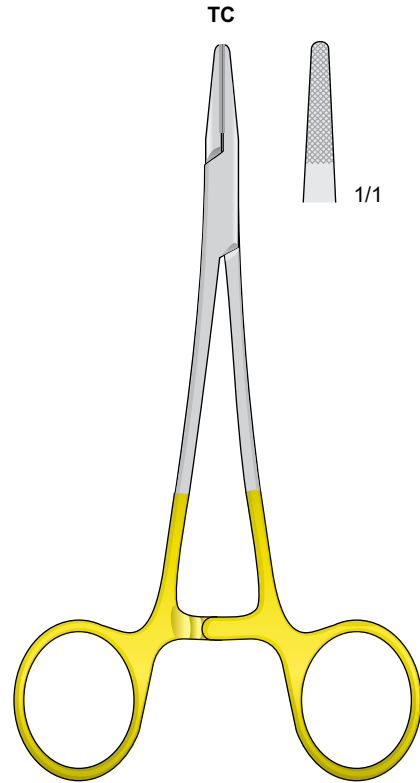

CRILE-WOOD
NH 770-18 18 cm

Port'aghi, pinze per fili d'acciaio
 Needle holder, wire forceps
 Nadelhalter, Draht-Zangen
 Porte-aiguilles, pinces à saisir
 Porta agujas, pinzas para hilos

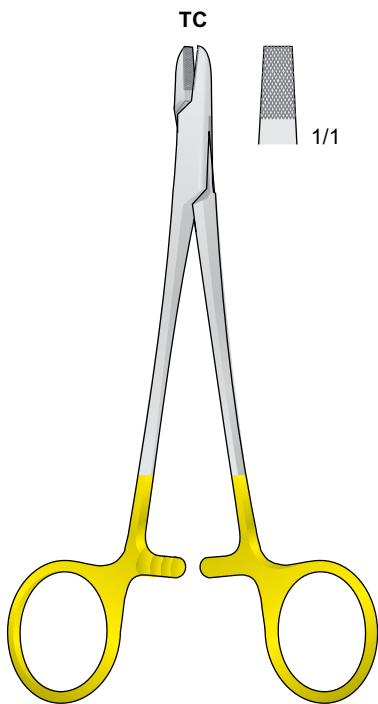

NH 771-15 15 cm

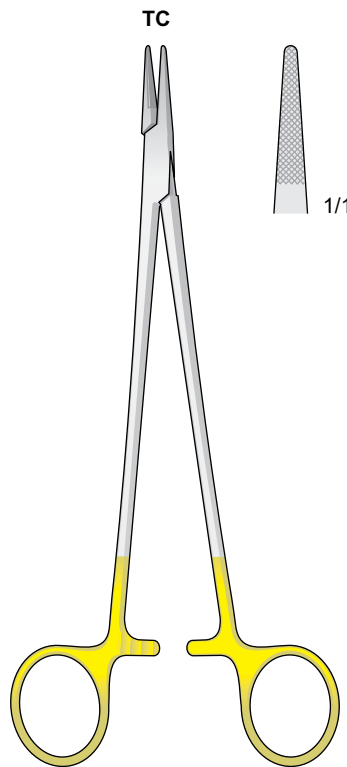

HEGAR-MAYO-SEELEY
NH 772-20 20 cm

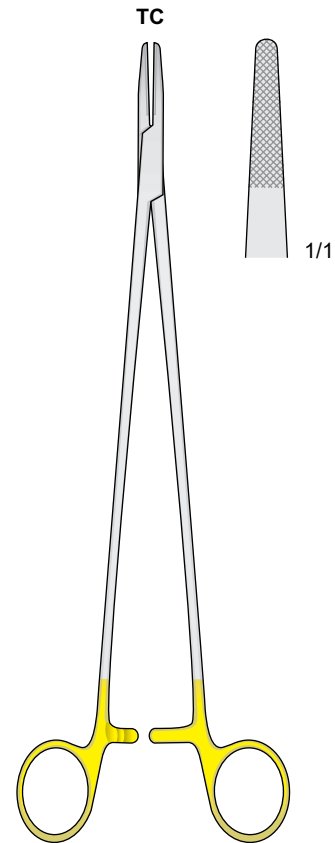

WANGENSTEEN
NH 773-27 27 cm

Port'aghi con forbici - Needle holders with scissors - Nadelhalter mit Schere - Porte aiguilles avec ciseaux - Portaagujas con tijeras

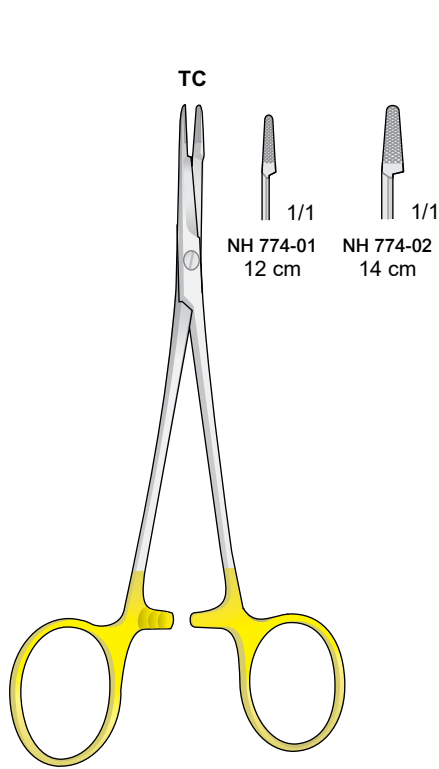

OLSEN-HEGAR
NH 774-01 / NH 774-02

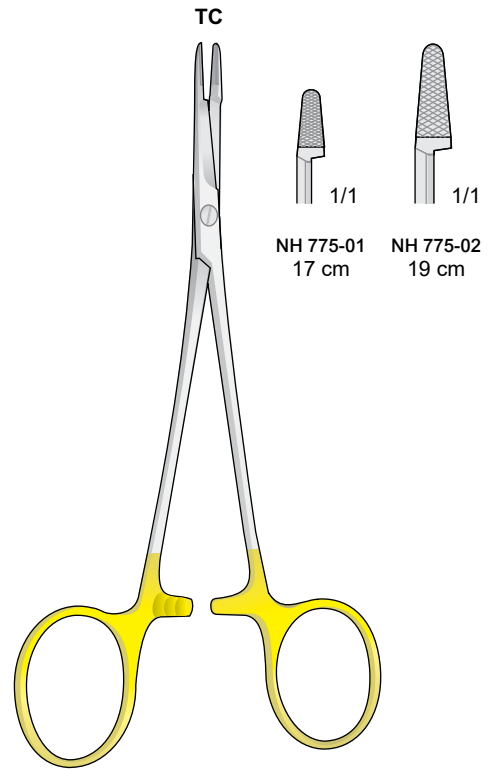

OLSEN-HEGAR
NH 775-01 / NH 775-02

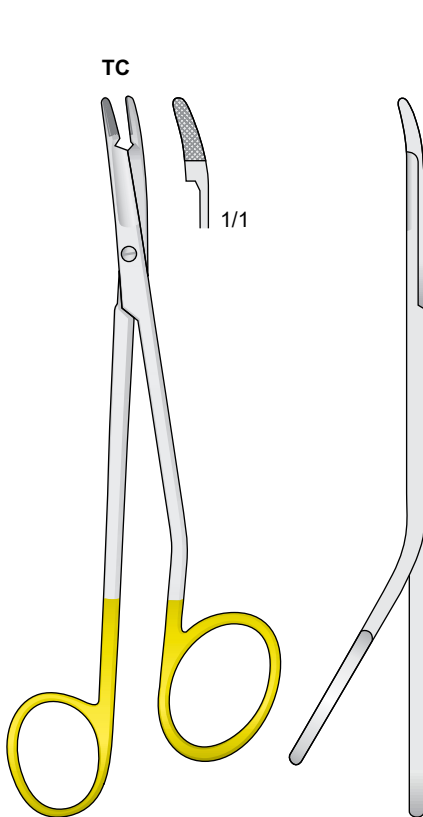

MINI-GILLIES
NH 776-14 14.5 cm

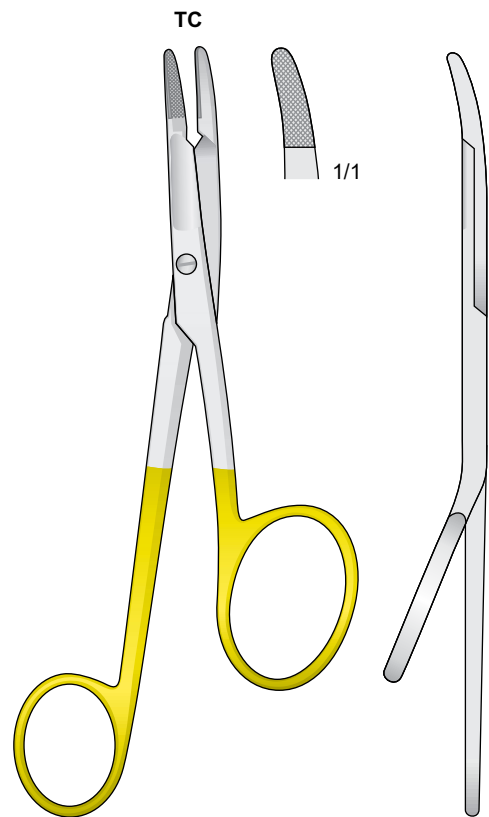

GILLIES
NH 777-16 16 cm

Portaghi con inserti al tungsteno - Needle Holders with tungsten-carbide inserts
 Nadelhalter mit Hartmetalleinlagen - Porte aiguilles avec plaquettes en carbure de tungstène
 Portaagujas con plaquitas de carburo de tungsteno

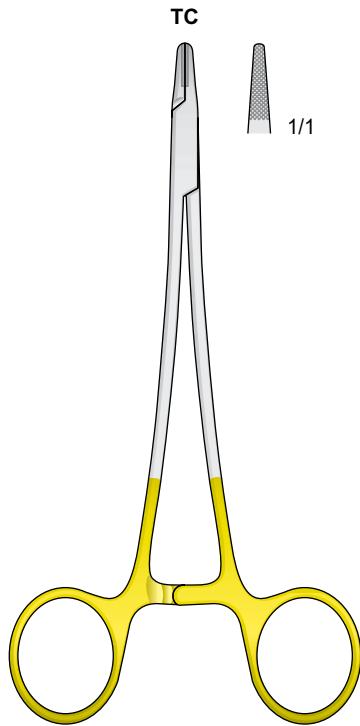

NH 778-14 14.5 cm

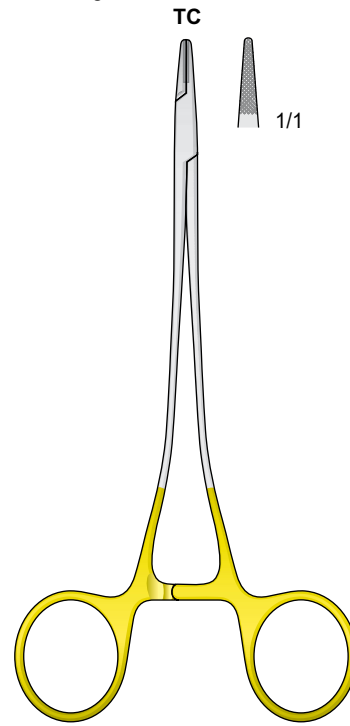

NH 779-15 15 cm

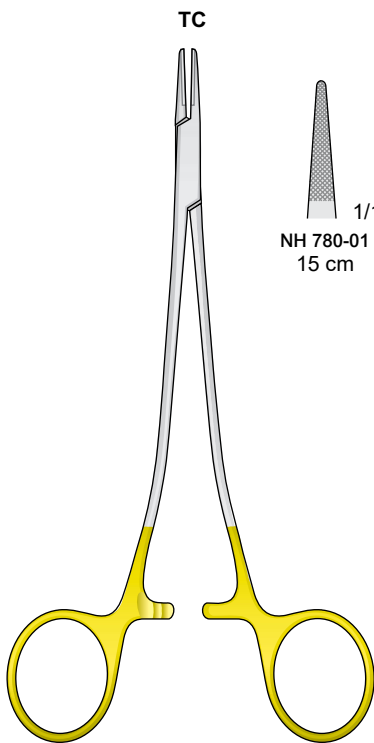

**SAROT
 NH 780-01 / NH 780-03**

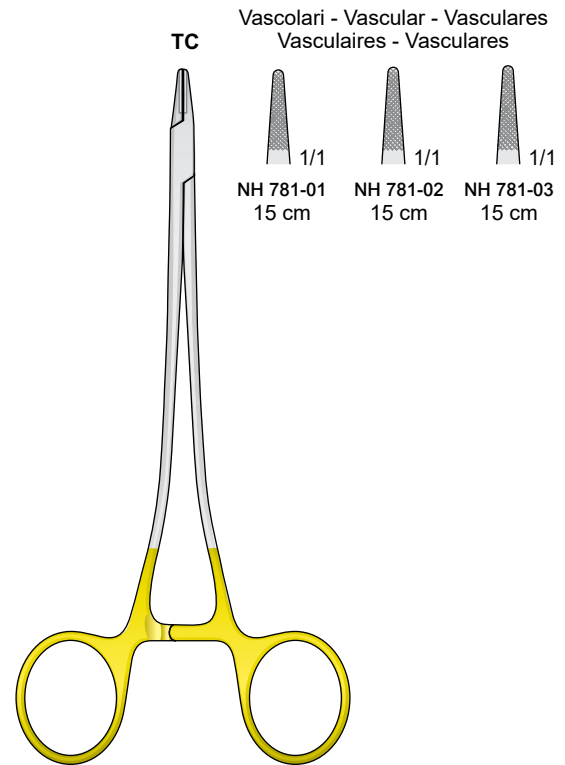
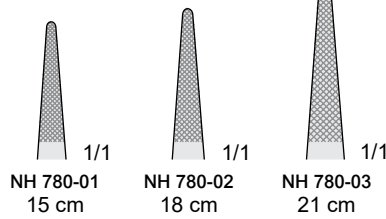

**SWEDESH MOD.
 NH 781-01 / NH 781-03**

Portaghi con inserti al tungsteno - Needle Holders with tungsten-carbide inserts
Nadelhalter mit Hartmetalleinlagen - Porte aiguilles avec plaquettes en carbure de tungstène
Portaagujas con plaquitas de carburo de tungsteno

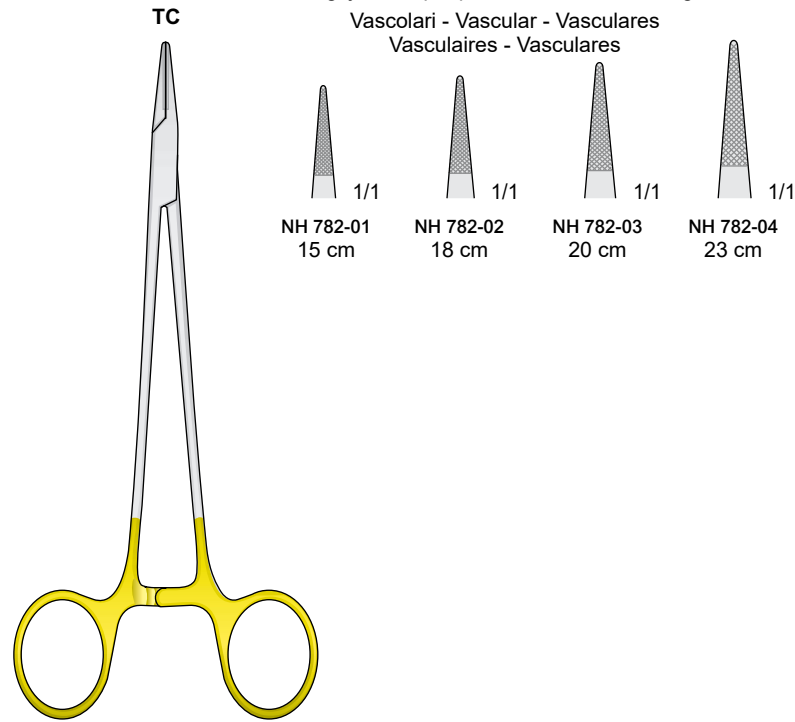

MICRO-VASCULAR
NH 782-01 / NH 782-04

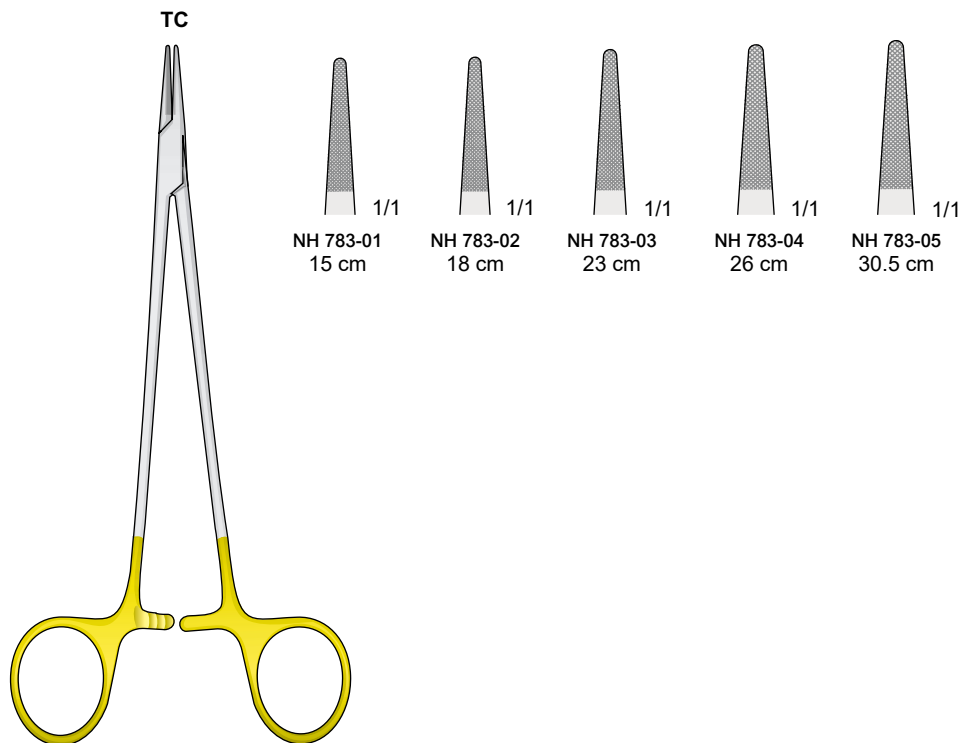

DE BAKEY
NH 783-01 / NH 783-05

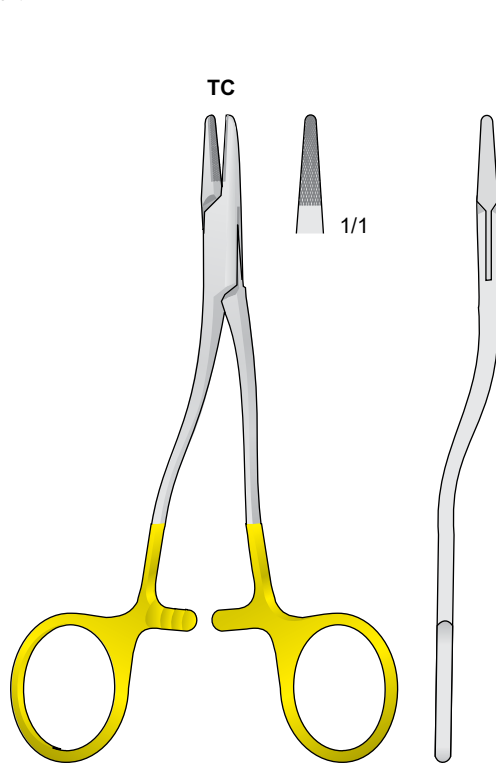

KILNER
NH 784-13 13 cm

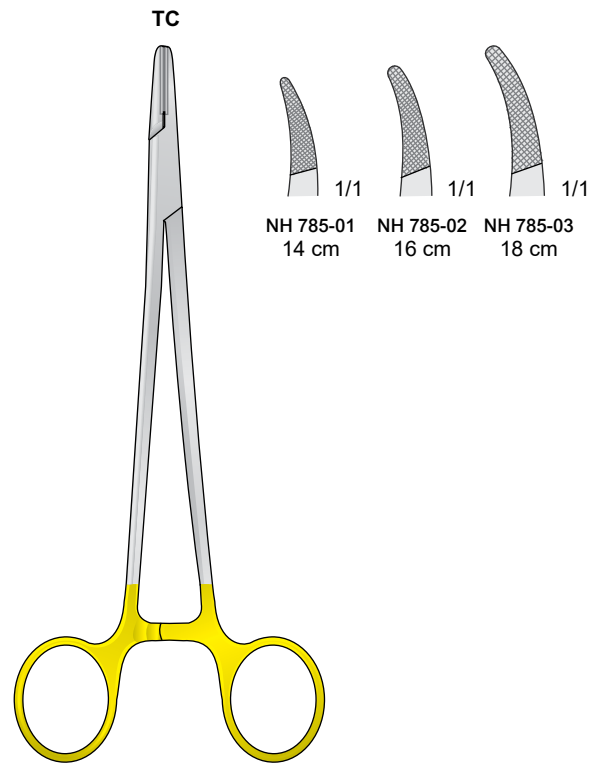

MAYO-HEGAR-HEANEY
NH 785-01 / NH 785-03

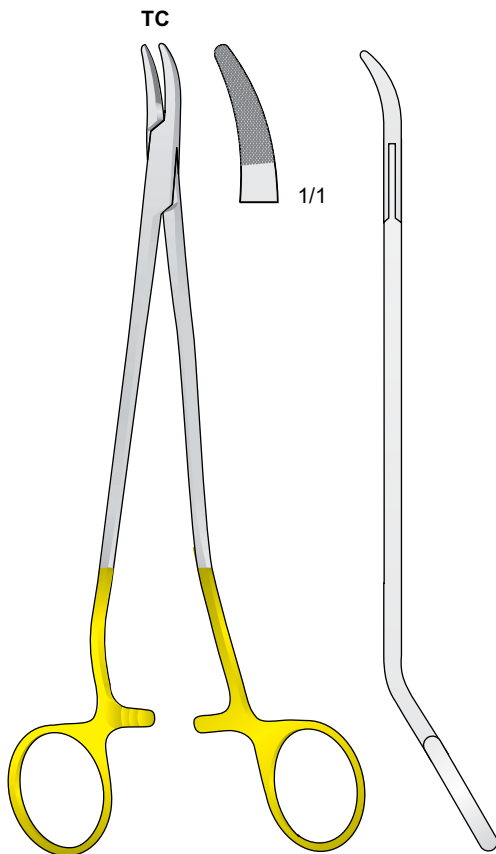

S-FORMING
NH 786-20 20 cm

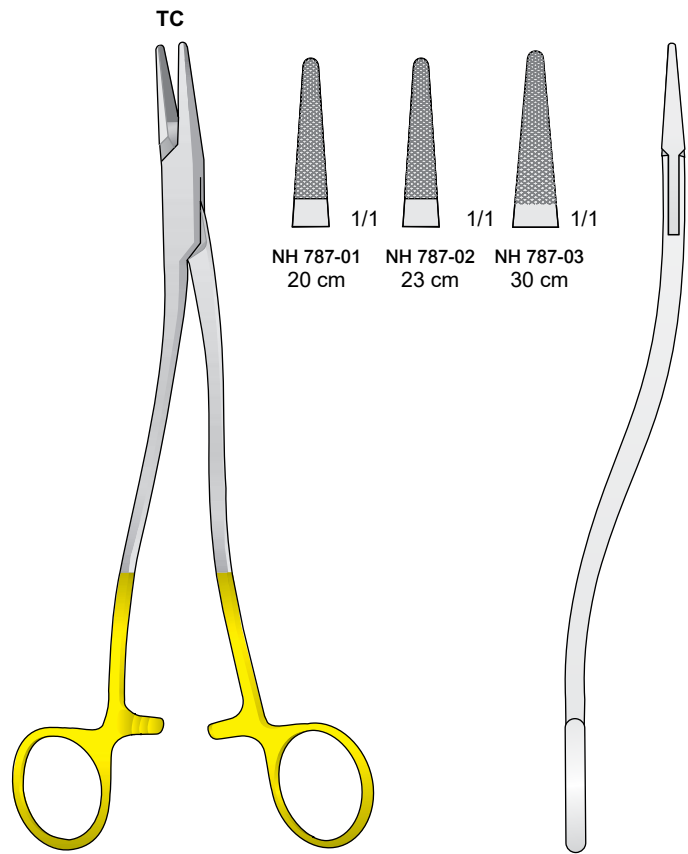

WERTHEIM
NH 787-01 / NH 787-03

Portaghi con inserti al tungsteno - Needle Holders with tungsten-carbide inserts
Nadelhalter mit Hartmetalleinlagen - Porte aiguilles avec plaquettes en carbure de tungstène
Portaagujas con plaquitas de carburo de tungsteno

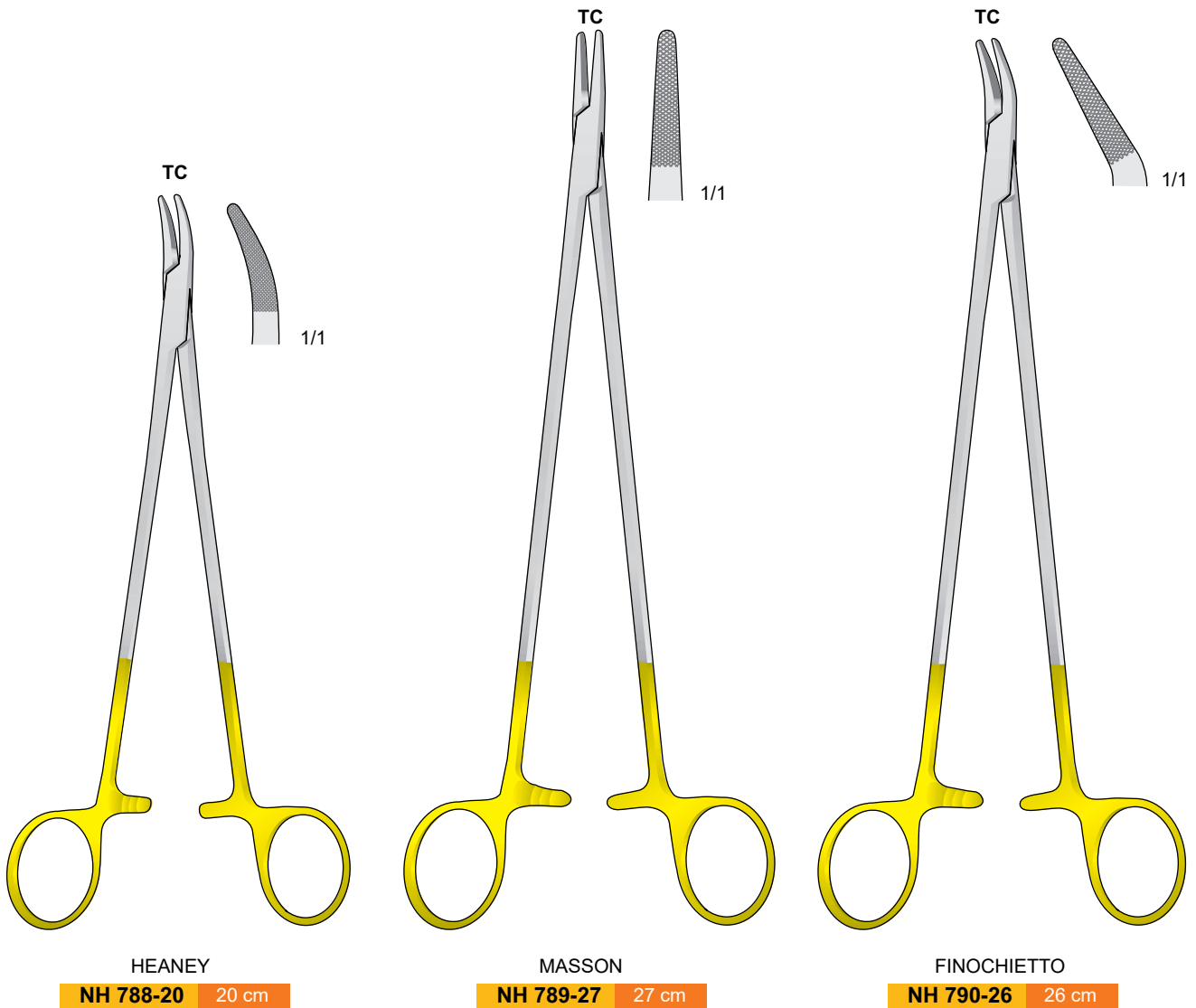

Portaghi con inserti al tungsteno - Needle Holders with tungsten-carbide inserts
 Nadelhalter mit Hartmetalleinlagen - Porte aiguilles avec plaquettes en carbure de tungstène
 Portaagujas con plaquitas de carburo de tungsteno

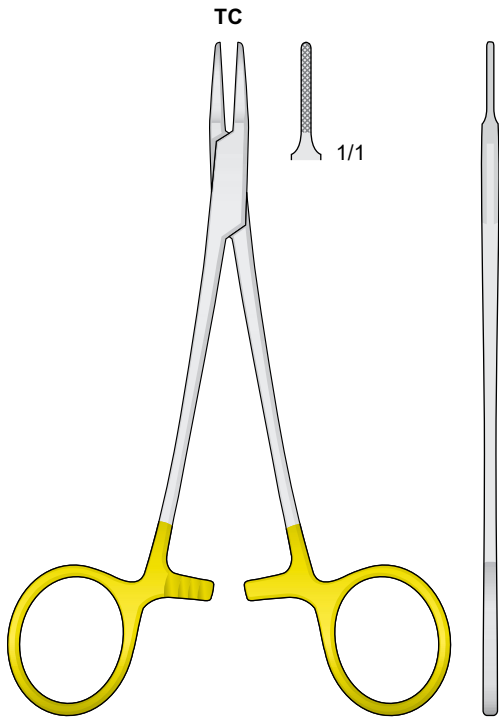

MICRO-RYDER

NH 791-14 14 cm

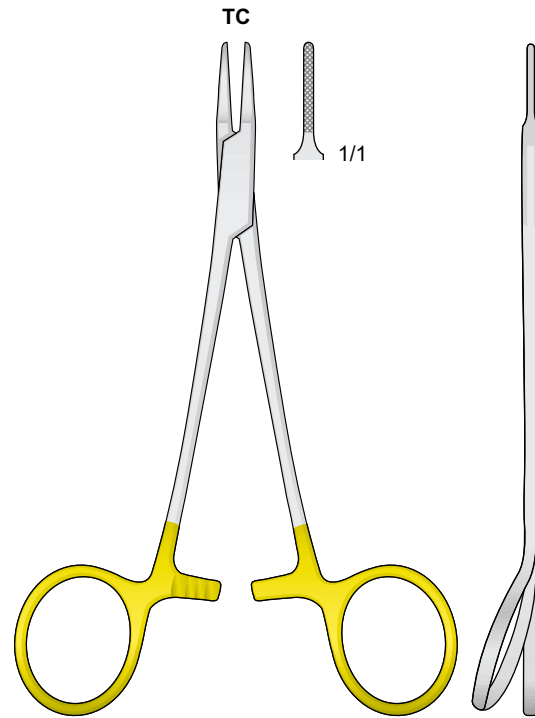

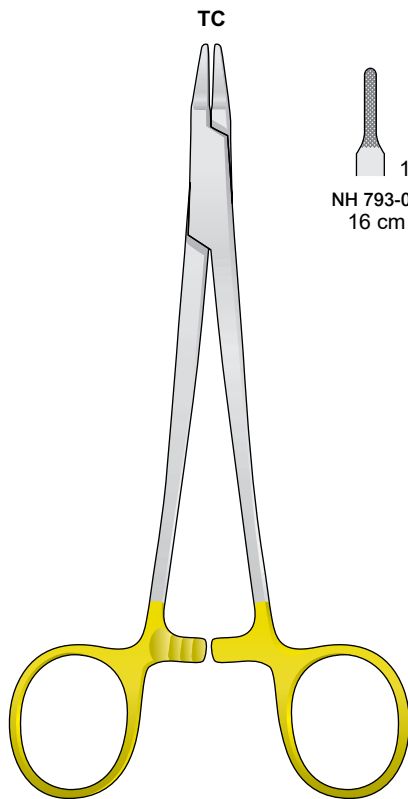

NH 792-14 14 cm



RYDER

NH 793-01 / NH 793-03

- | | | |
|---|---|---|
| 
1/1
NH 793-01
16 cm | 
1/1
NH 793-02
18 cm | 
1/1
NH 793-03
20 cm |
|---|---|---|

Portaghi con inserti al tungsteno - Needle Holders with tungsten-carbide inserts
Nadelhalter mit Hartmetalleinlagen - Porte aiguilles avec plaquettes en carbure de tungstène
Portaagujas con plaquitas de carburo de tungsteno

TC

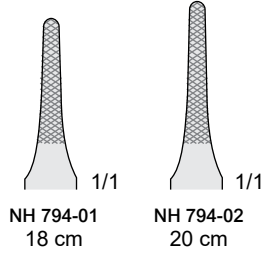
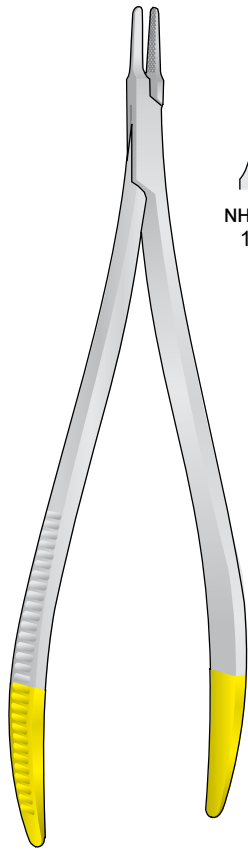

LANGENBECK-RYDER
NH 794-01 / NH 794-02

TC

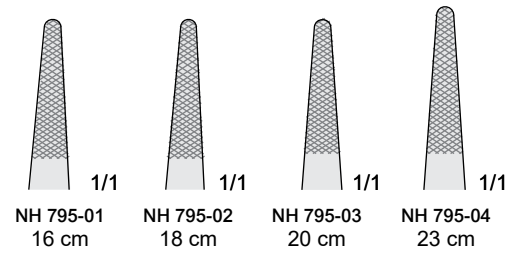
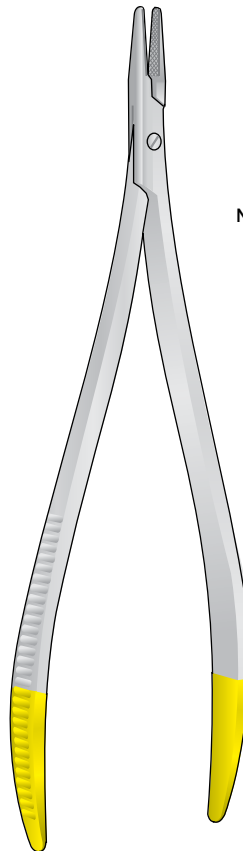

LANGENBECK

TC

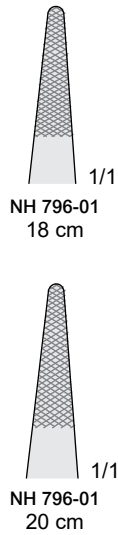
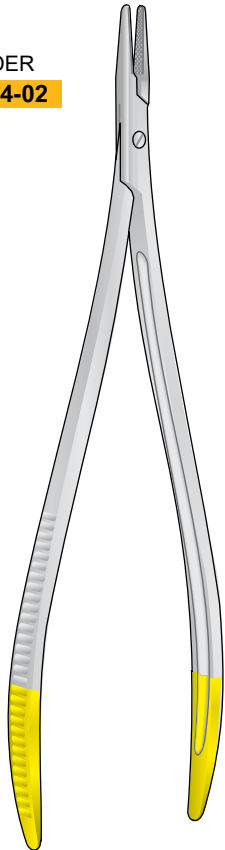

TÖNNIS

NH 796-01 / NH 796-02

TC

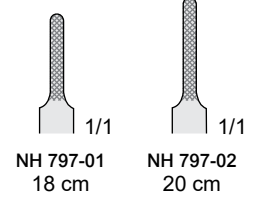
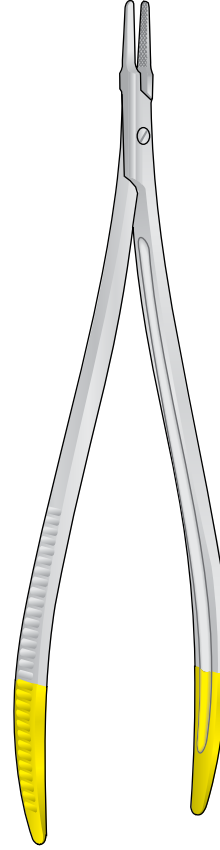

TÖNNIS-RYDER

NH 797-01 / NH 797-02

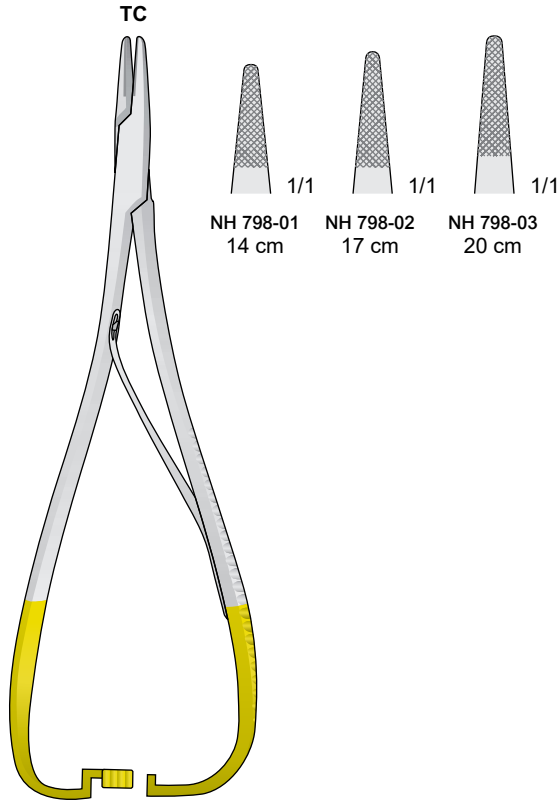

MATHIEU
NH 798-01 / NH 798-03

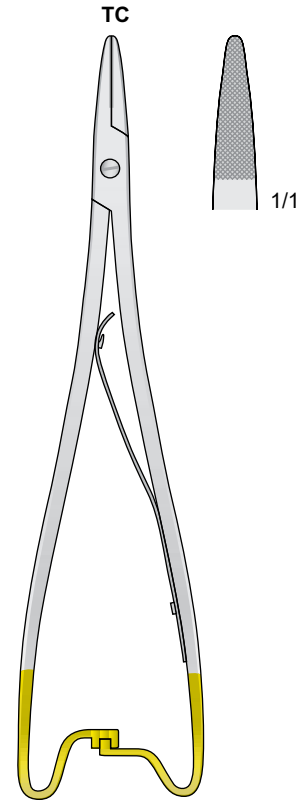

MATHIEU
NH 799-20 20 cm

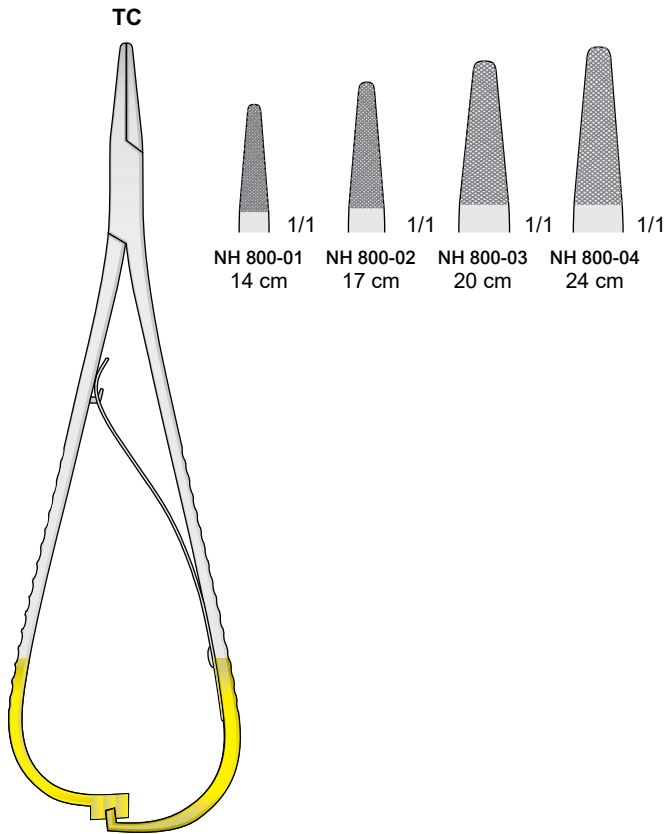

MATHIEU
NH 800-01 / NH 800-04

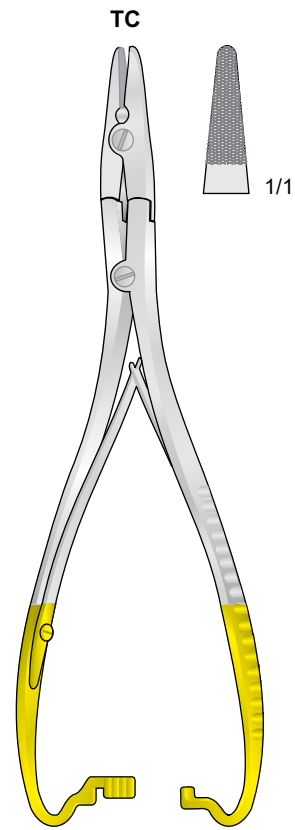

NH 801-20 20 cm

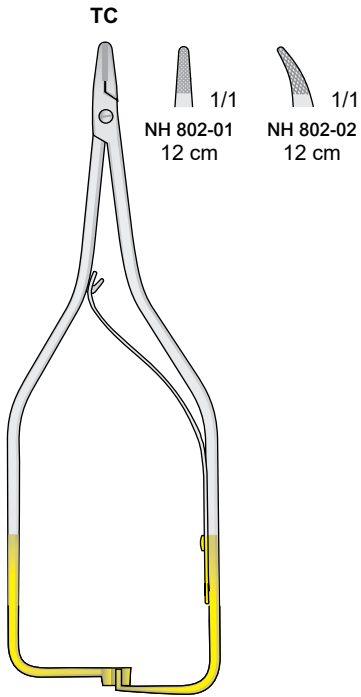

BOYNTON
NH 802-01 / NH 802-02

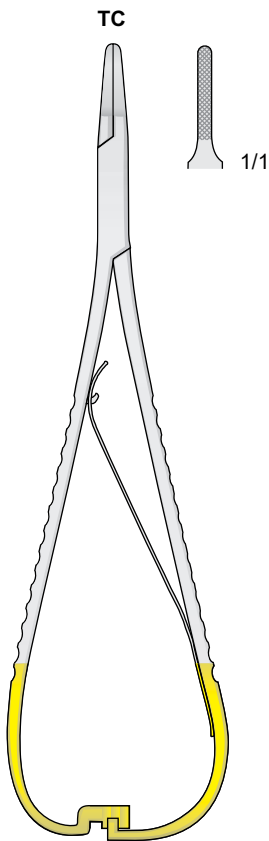

LICHTENBERG
NH 803-17 17.5 cm

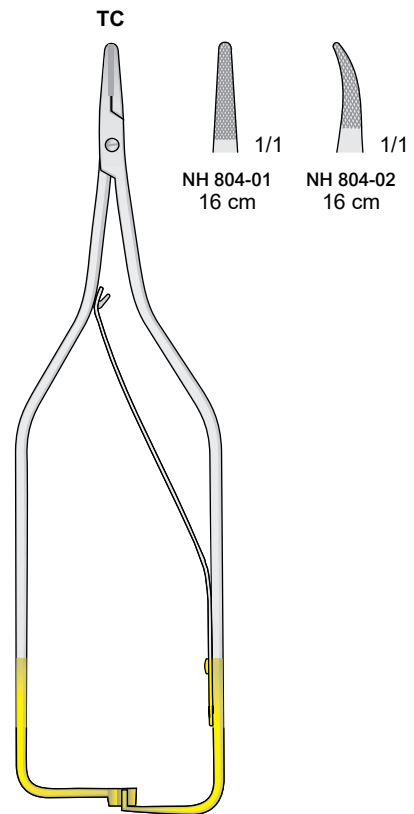

ARRUGA
NH 804-01 / NH 804-02

Aghi per legatur
 Ligature needle
 Unterbindungsnadeln
 Aiguilles à ligatures
 Agujas para ligaduras

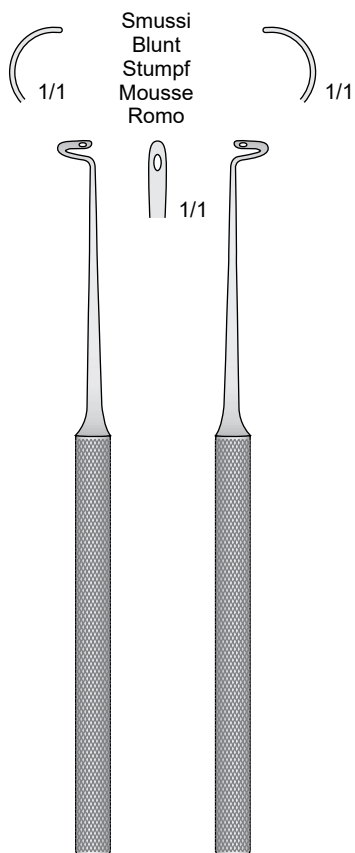

KRONECKER LN 805-13
13 cm

KRONECKER LN 806-13
13 cm

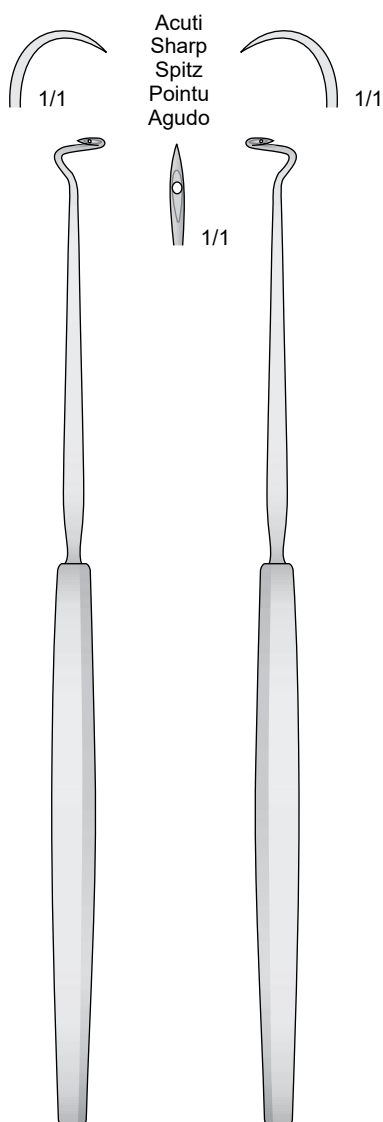

DUPUY-WEISSE LN 807-22
22 cm

DUPUY-WEISSE LN 808-22
22 cm

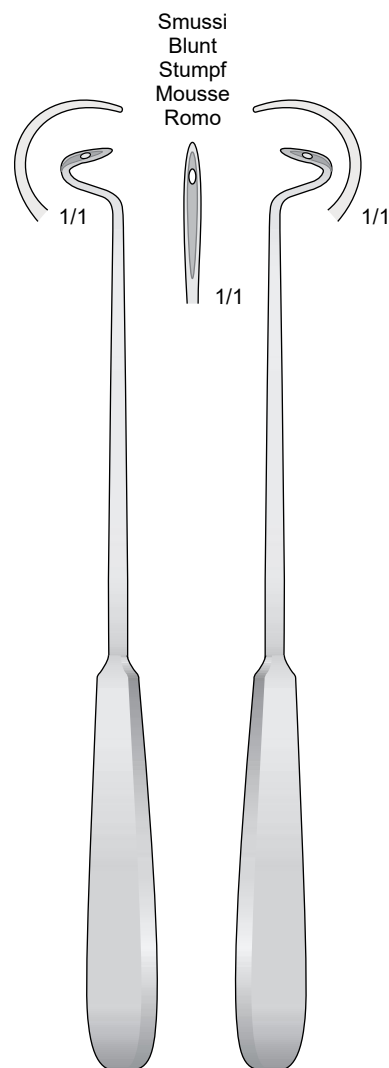

DESCHAMPS LN 809-20
20 cm

DESCHAMPS LN 810-20
20 cm

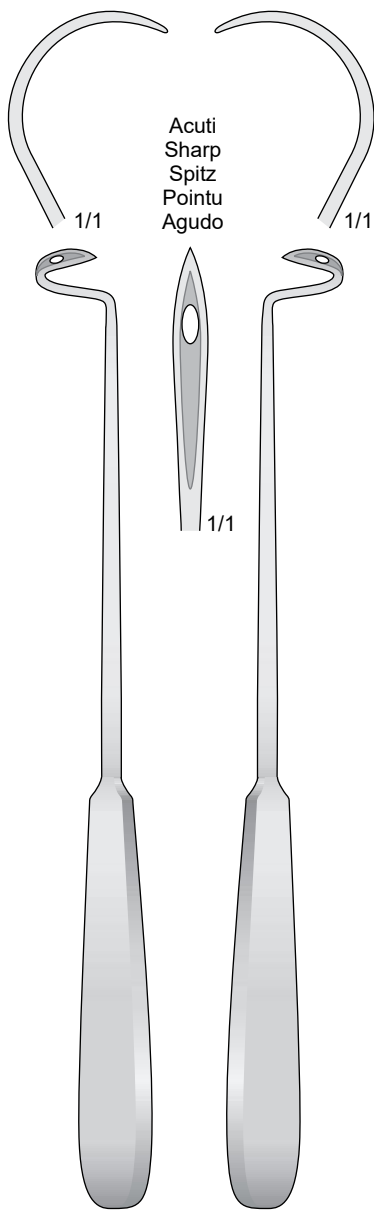

DESCHAMPS LN 811-21 21 cm
DESCHAMPS LN 812-21 21 cm

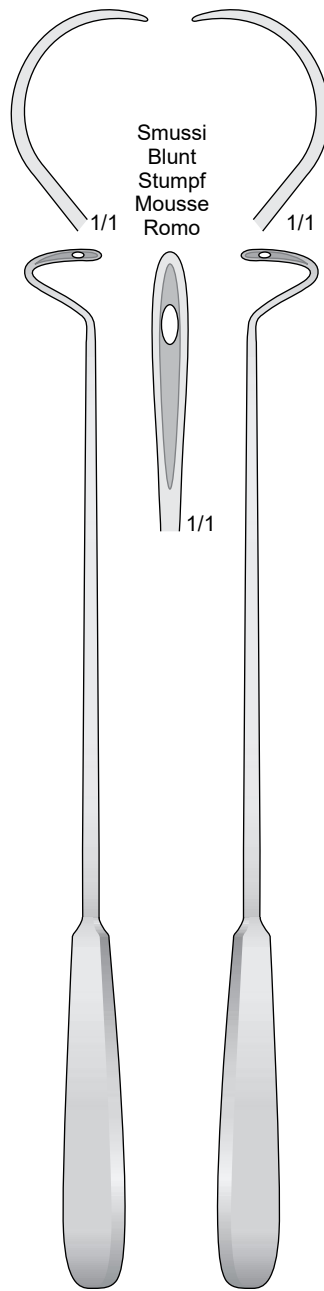

DESCHAMPS LN 812-27 27 cm
DESCHAMPS LN 813-27 27 cm

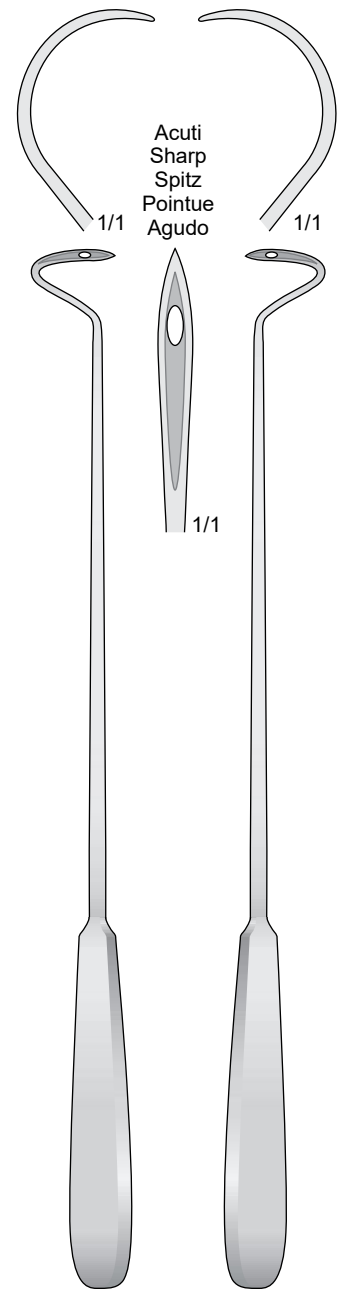

DESCHAMPS LN 814-27 27 cm
DESCHAMPS LN 815-27 27 cm

Aghi per legatur
 Ligature needle
 Unterbindungsnadeln
 Aiguilles à ligatures
 Agujas para ligaduras

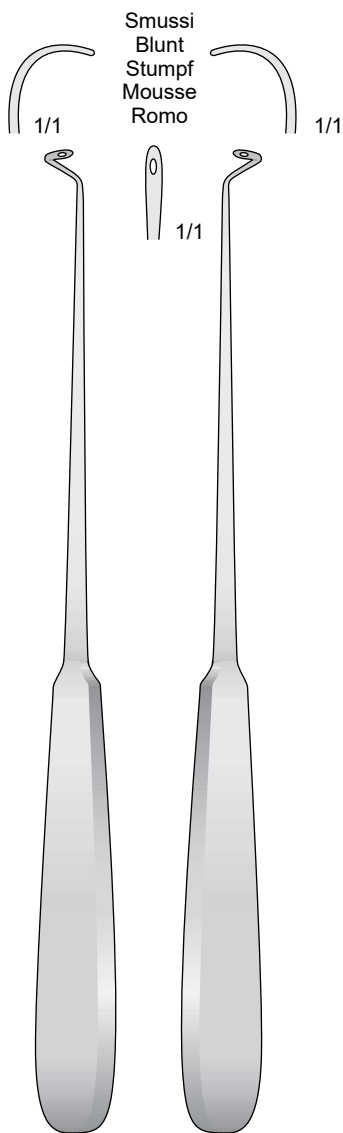

DESCHAMPS LN 816-22 22.5 cm
 DESCHAMPS LN 817-22 22.5 cm

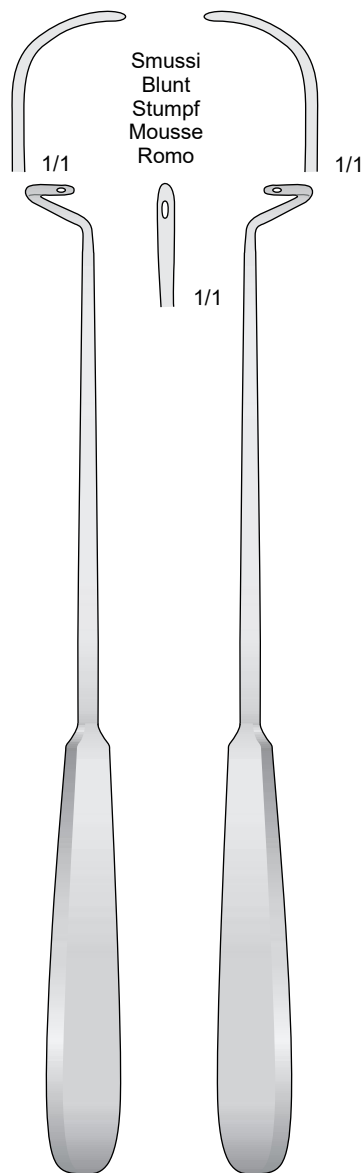

DESCHAMPS LN 818-22 22.5 cm
 DESCHAMPS LN 819-22 22.5 cm

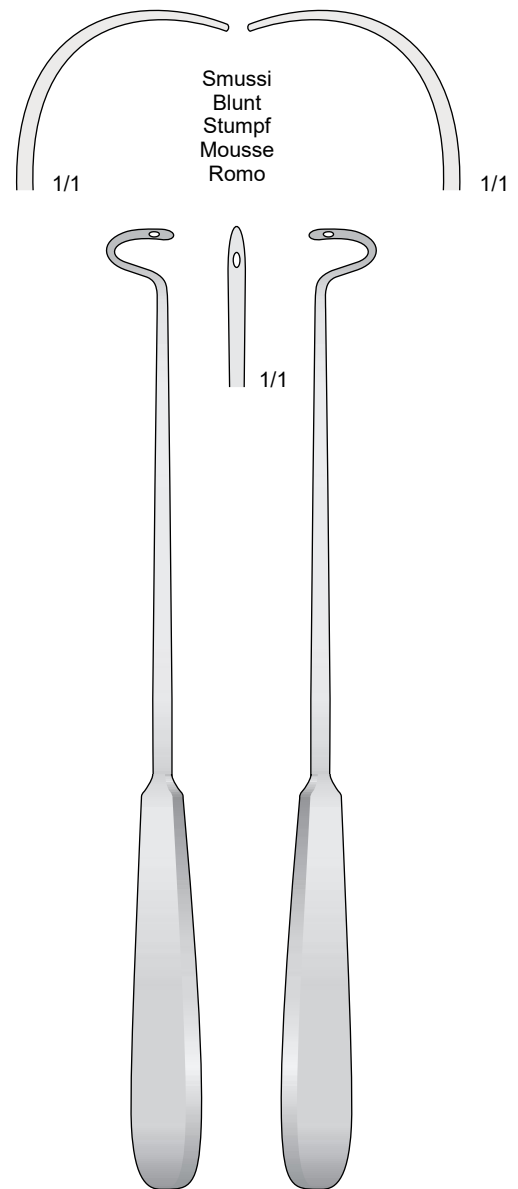

DESCHAMPS LN 820-22 22.5 cm
 DESCHAMPS LN 821-22 22.5 cm



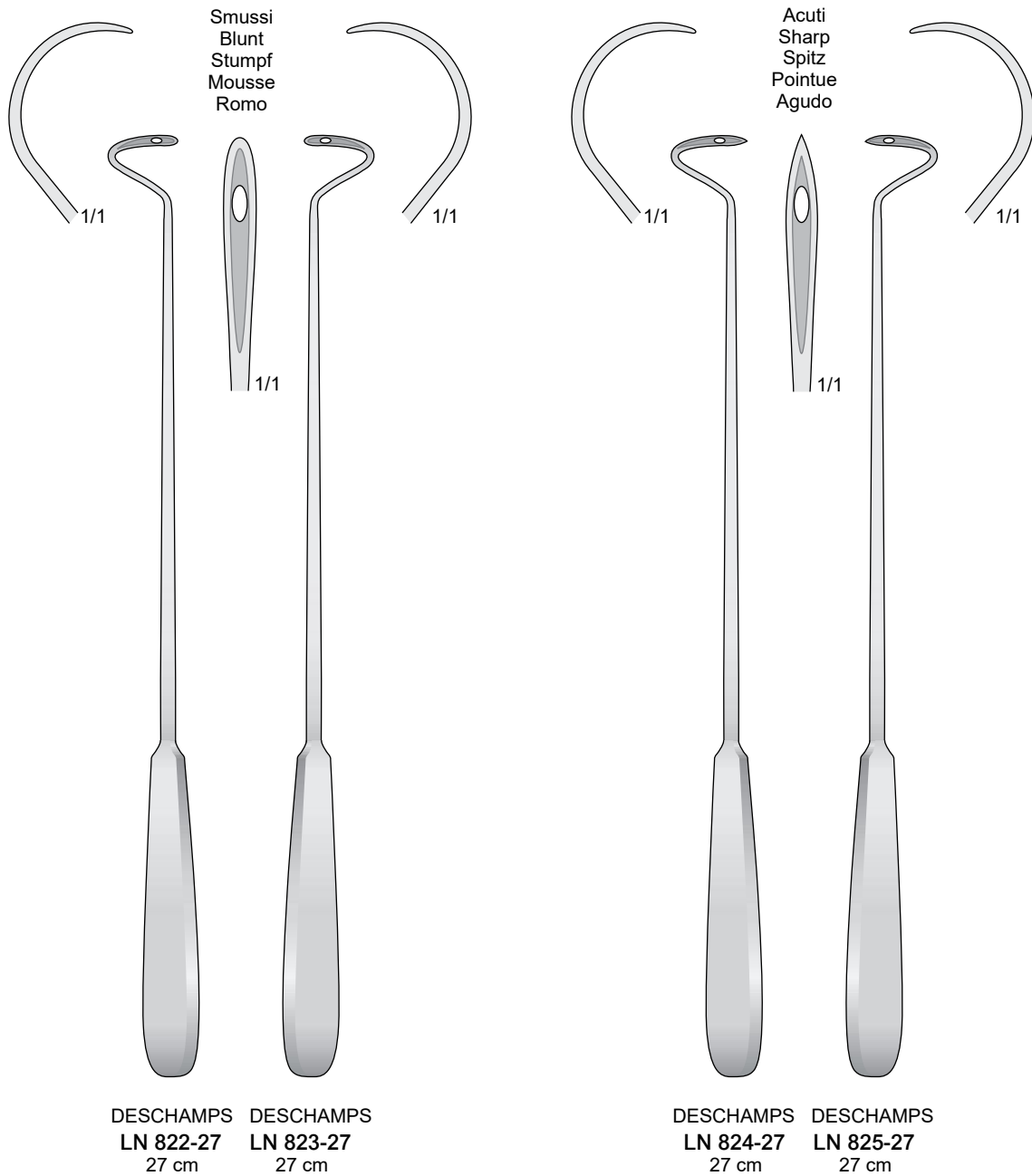

Aghi per legatur
Ligature needle
Unterbindungsnadeln
Aiguilles à ligatures
Agujas para ligaduras

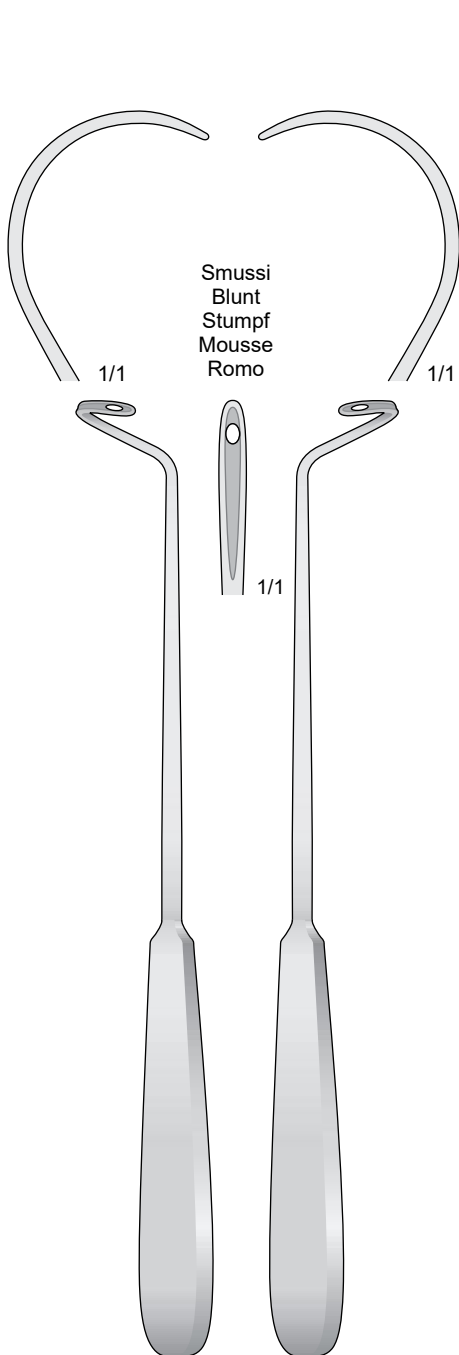

DESCHAMPS DESCHAMPS
LN 826-24 LN 827-24
24 cm 24 cm

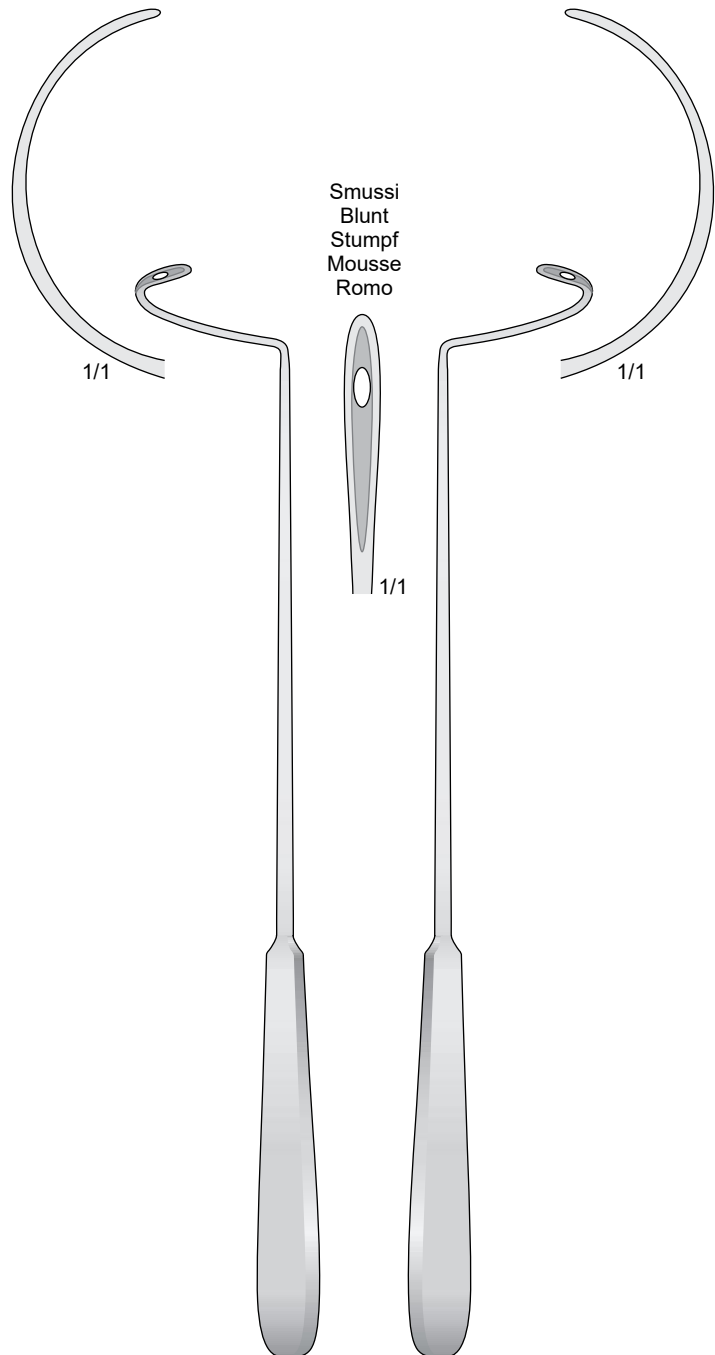

DESCHAMPS DESCHAMPS
LN 828-28 LN 829-28
28 cm 28 cm

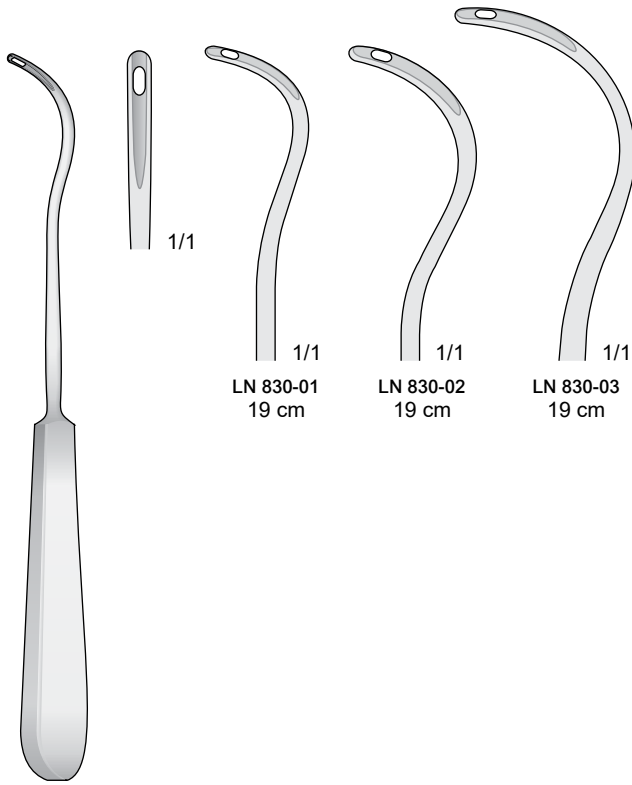

KOCHER
LN 830-01 / LN 830-03

Malleabile
Flexible
Biegsam
Souple
Maleable

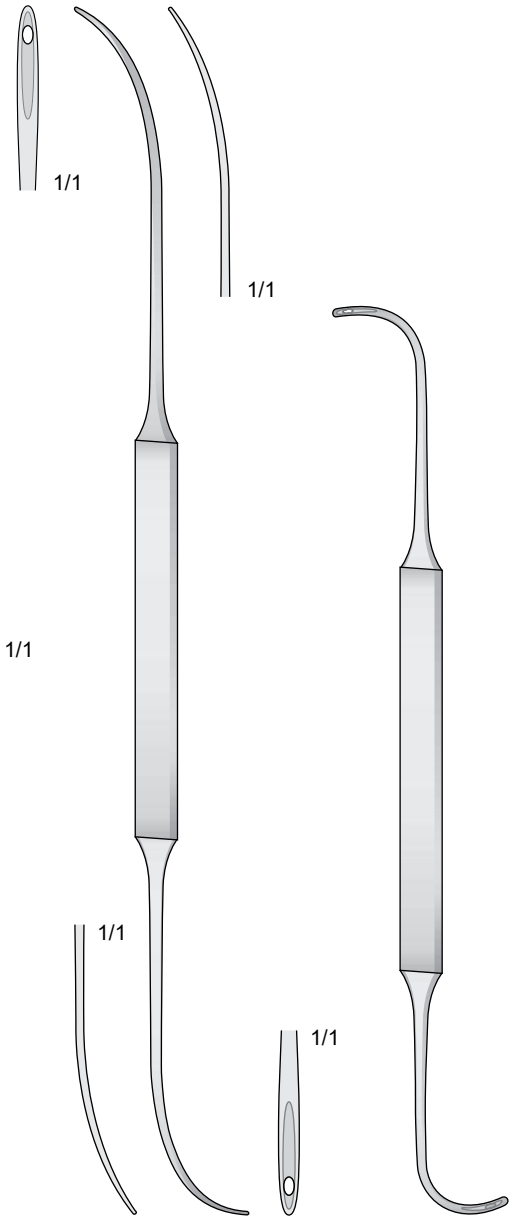

SCHMIEDEN-DICK
LN 833-32 32 cm

SCHMIEDEN
LN 834-21 21 cm

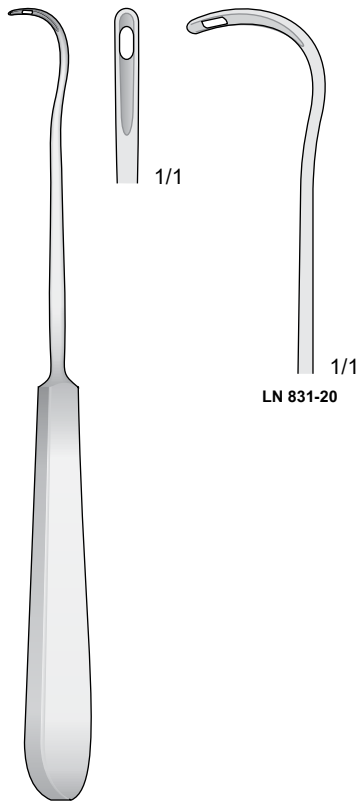

COOPER
LN 831-20 20 cm

COOPER
LN 832-19 19 cm

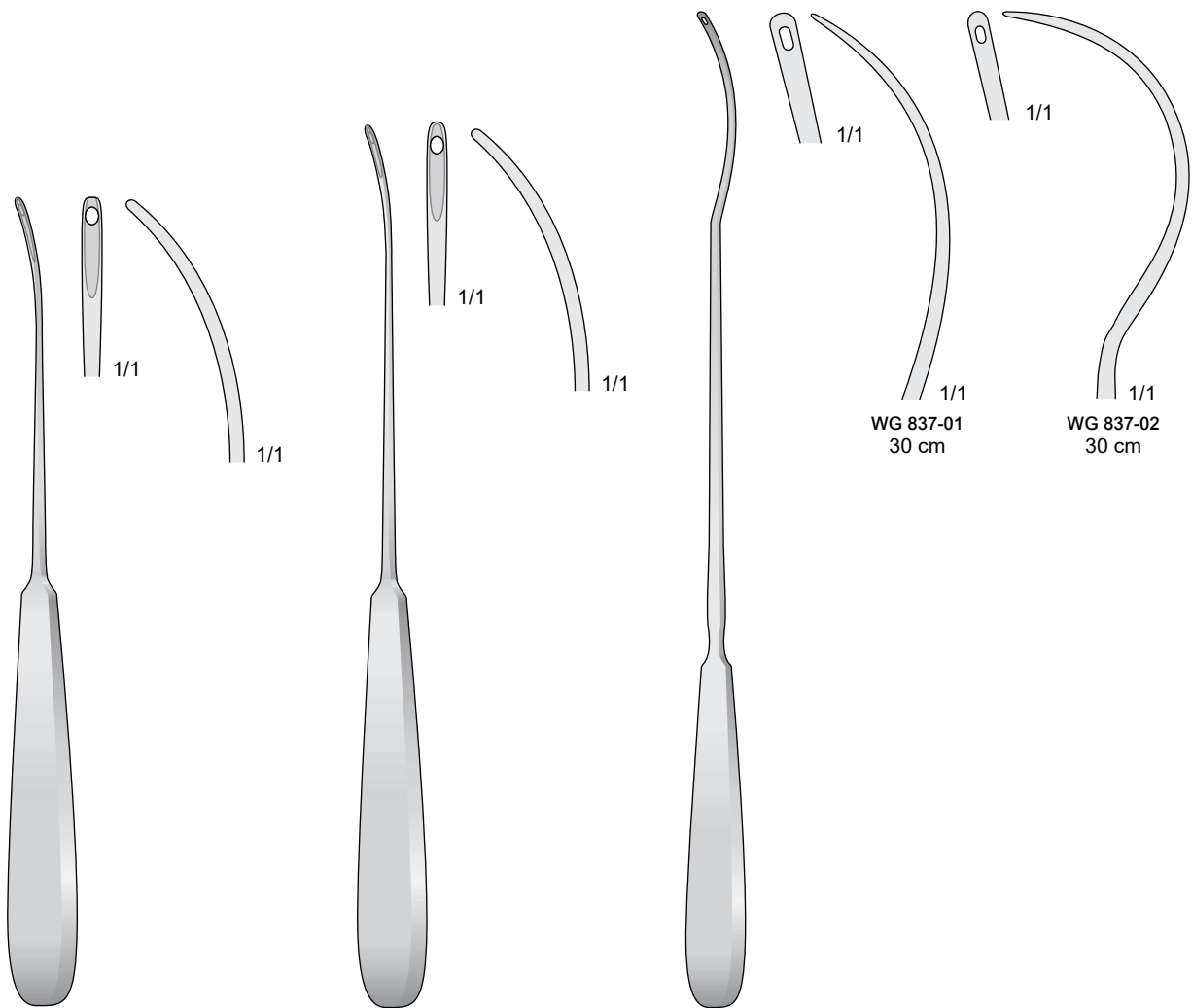

WG 835-20 20 cm

WG 836-23 23 cm

BRUNNER
WG 837-01 / WG 837-02

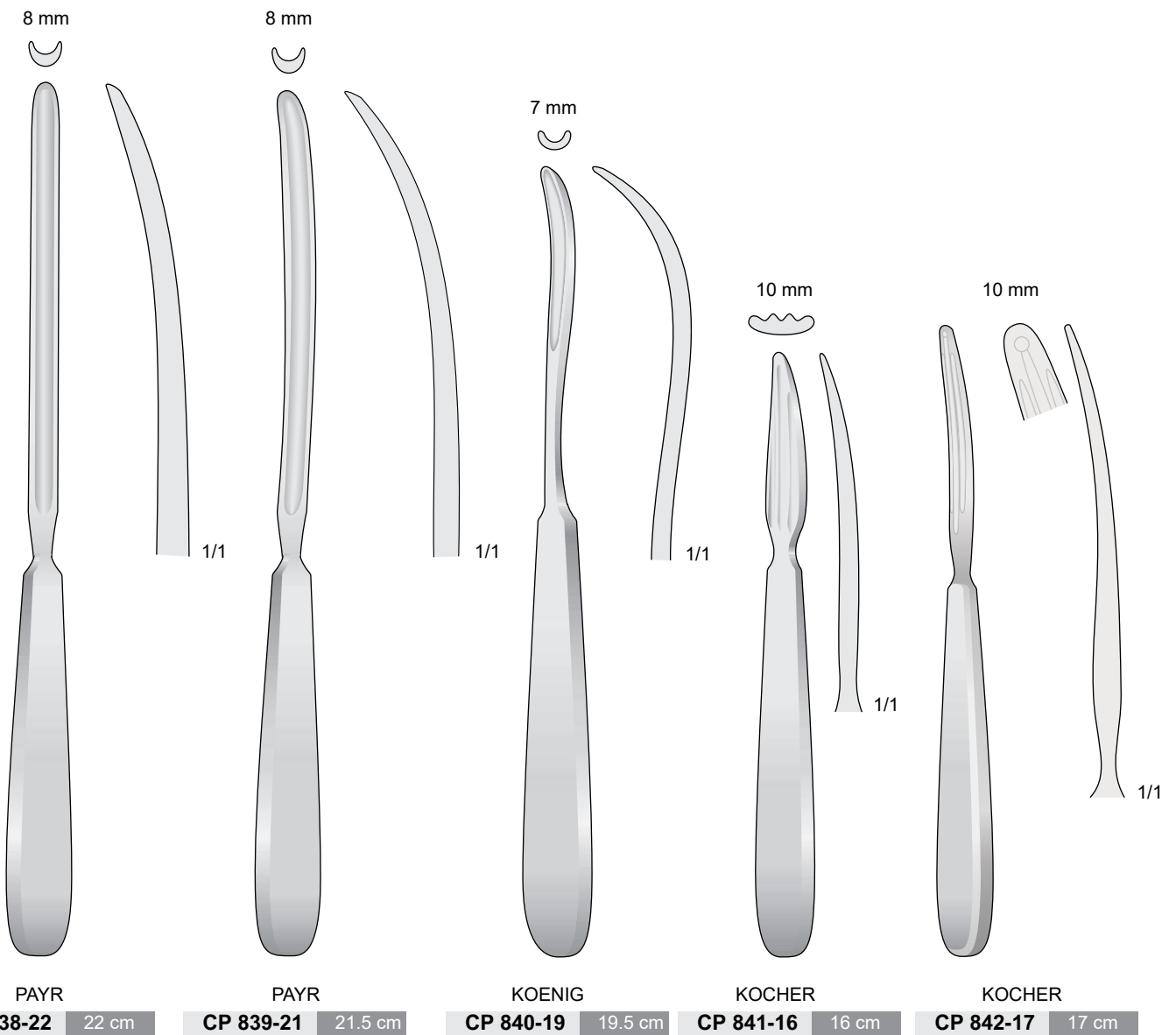

Char. 8	= 2,75 mm
Char 10	= 3,3 mm
Char 12	= 4 mm
Char 14	= 4,6 mm
Char 16	= 5,3 mm
Char 18	= 6 mm



Punta a coltello
 Messerspitze gebogen
 Knife tip curved

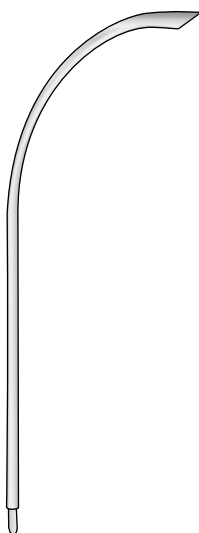

Punta a coltello
 Messerspitze gebogen
 Knife tip curved

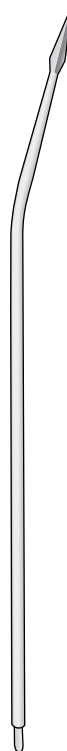

Punta a lancetta
 Lanzettenspitze gebogen
 Lancet tip curved

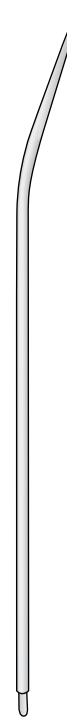

Punta Trocar
 Dreikanterspitze gebogen
 Trocar tip curved

Charr.

8	RGN 843-1	RGN 844-1	RGN 845-1	RGN 846-1
10	RGN 843-2	RGN 844-2	RGN 845-2	RGN 846-2
12	RGN 843-3	RGN 844-3	RGN 845-3	RGN 846-3
14	RGN 843-4	RGN 844-4	RGN 845-4	RGN 846-4
16	RGN 843-5	RGN 844-5	RGN 845-5	RGN 846-5
18	RGN 843-6	RGN 844-6	RGN 845-6	RGN 846-6

1/1

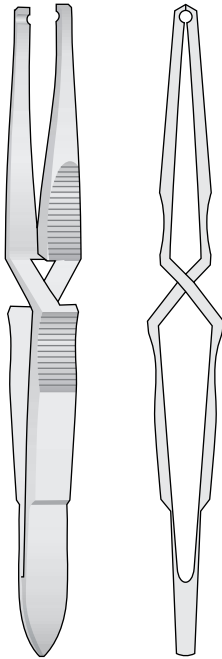

HEGENBARTH

CF 847-12 12.5 cm

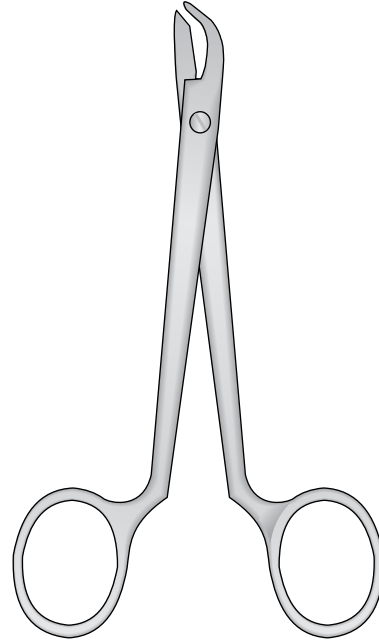

COLLIN

CF 848-13 13.5 cm

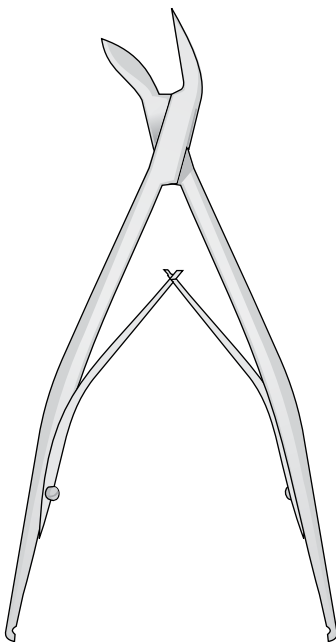

MICHEL

CF 849-13 13 cm

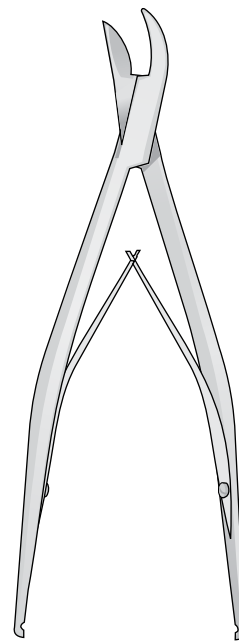

MICHEL

CF 850-12 12 cm



we take a closer look

Probes + Cotton Applicator



Sonden | Watteträger
Sondes | Applicateur de coton
Sondas | Porta-algodón
Sonde | Portacotone

Hohlsonde

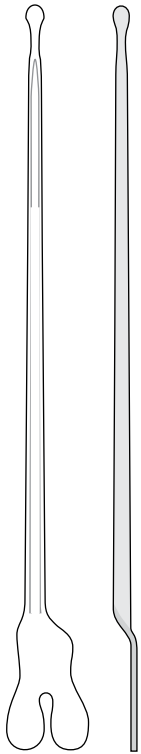

P 855-14	14.5 cm
P 855-16	16 cm
P 855-18	18 cm
P 855-20	20 cm

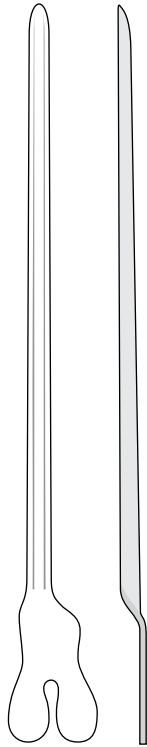

P 856-13	13 cm
P 856-14	14.5 cm
P 856-16	16 cm
P 856-18	18 cm
P 856-20	20 cm

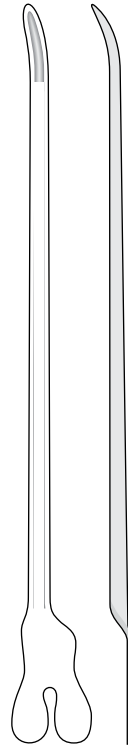

DOYEN
P 857-14 14 cm

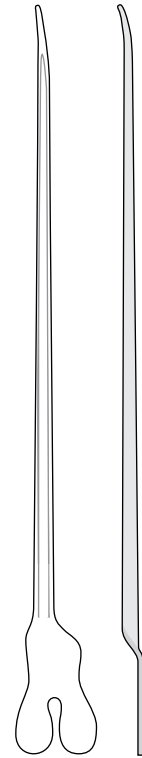

NELATON
P 858-16 16 cm

Sonde per fistole - Fistula probes - Fistelsonden - Sondes pour fistulas - Sondas para fistulas

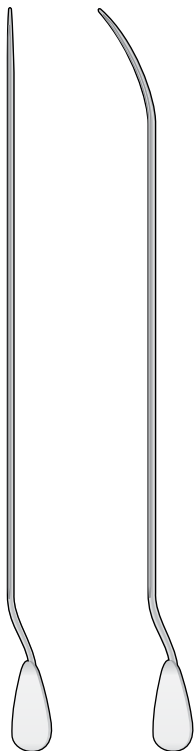

LOCHART
P 859-17 17 cm

LOCHART
P 860-17 17 cm

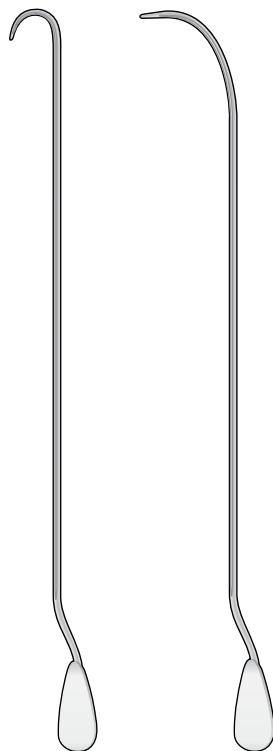

LOCHART
P 861-17 17 cm

LOCHART
P 862-17 17 cm

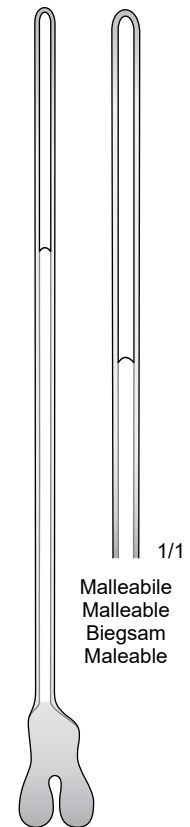

LOCHART
P 863-19 19 cm

1/1
Malleabile
Malleable
Biigsam
Maleable

Sonde bottonute
 Probes
 Sonden
 Sondes
 Estiletos

Ø 1 mm



Ø 1,5 mm



Ø 2 mm



Ø 2 mm



Ø 1,5 mm

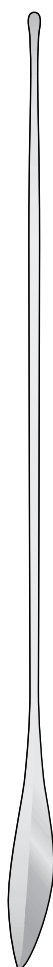

Ø 1,0 mm

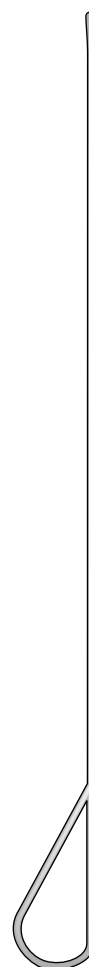

P 864-14	14.5cm
P 864-16	16 cm

P 865-13	13 cm
P 865-14	14.5cm
P 865-16	16 cm
P 865-20	20 cm

P 866-14	14.5cm
P 866-16	16cm
P 866-20	20 cm
P 866-25	25 cm

P 867-13	13 cm
P 867-14	14.5cm
P 867-16	16 cm
P 867-20	20 cm

P 868-14	14.5cm
-----------------	--------

STACKE
P 869-11
 11 cm

BOWMAN

P 870-01	00/0	P 870-04	5/6
P 870-02	1/2	P 870-05	7/8
P 870-03	3/4	P 870-06	6/7



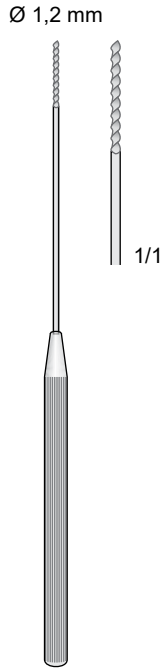

UNIVERSAL
CA 871-12 12 cm
CA 871-14 14 cm
CA 871-16 16 cm

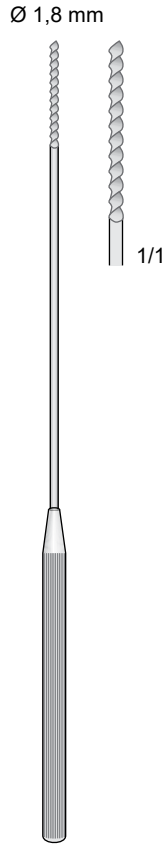

UNIVERSAL
CA 872-12 12 cm
CA 872-14 14 cm
CA 872-16 16 cm
CA 872-18 18 cm

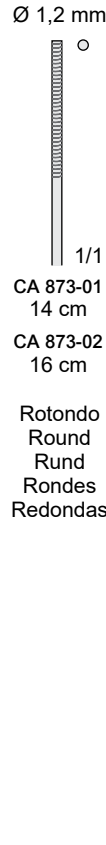

CA 873-01 14 cm
CA 873-02 16 cm
Rotondo
Round
Rund
Rondes
Redondas



CA 873-03 14 cm
CA 873-04 16 cm
Triangolare
Triangular
Dreikant
Triangulaires
Triangulares



CA 873-05 18 cm
Rotondo
Round
Rund
Rondes
Redondas

MOD. MARTIN
CA 873-01 / CA 873-05

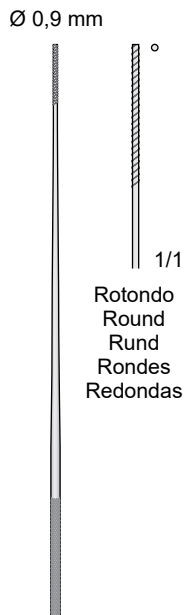

FARRELL
CA 874-12 12 cm

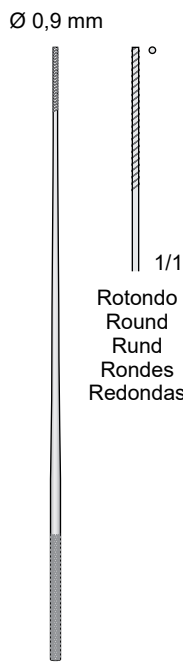

FARRELL
CA 875-14 14 cm
CA 875-16 16 cm
CA 875-18 18 cm

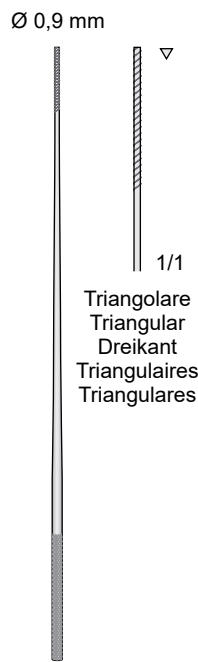

FARRELL
CA 876-14 14 cm
CA 876-16 16 cm

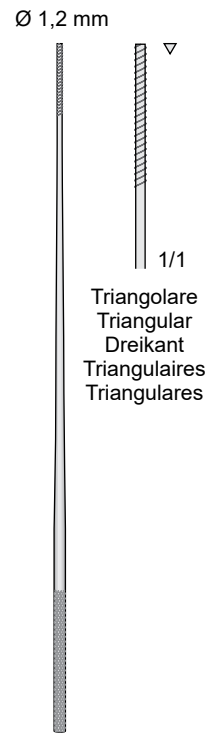

FARRELL
CA 877-18 18 cm

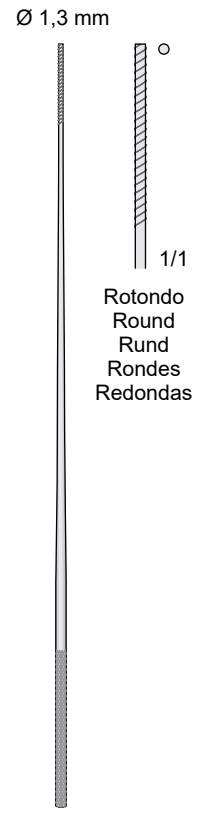

FARRELL
CA 878-23 23 cm

Porta cotone
 Cotton applicators
 Watteträger
 Porte cotons
 Portaalgodòn

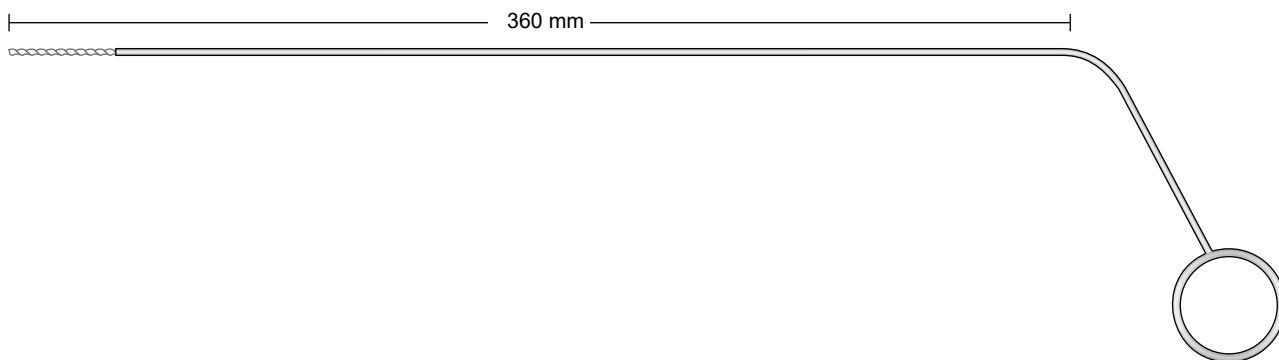

CA 879-40 40 cm

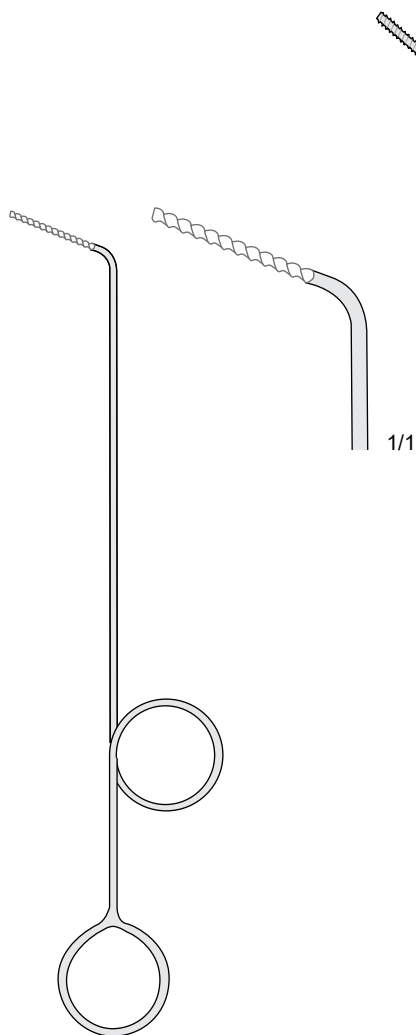

HARTMANN - Ø 2,3 mm
 CA 880-22 22 cm

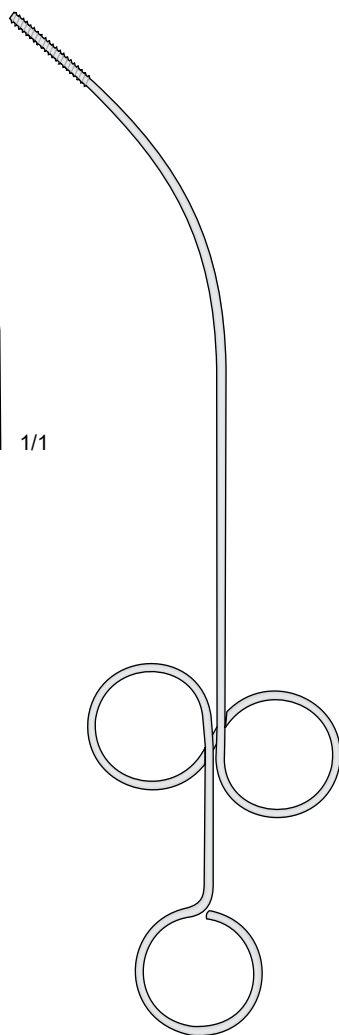

FEIN
 CA 881-25 25 cm

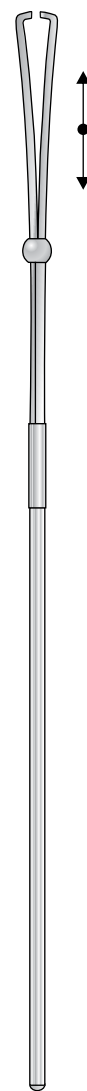

HEILDEBERG
 CA 882-18 18 cm

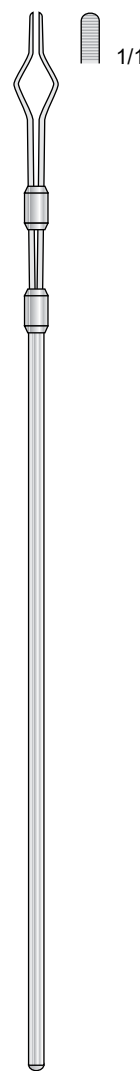

HEILDEBERG
 CA 883-17 17 cm



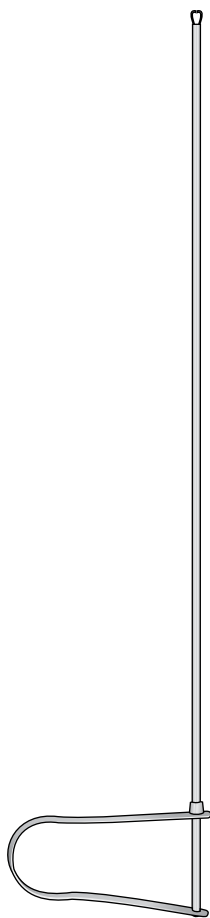

CA 884-30 30 cm

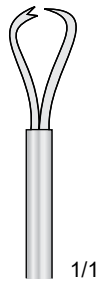

1/1

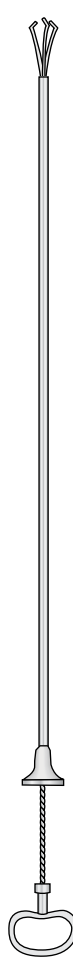

FRANKFELDT
CA 885-36 36 cm

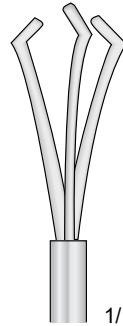

1/1

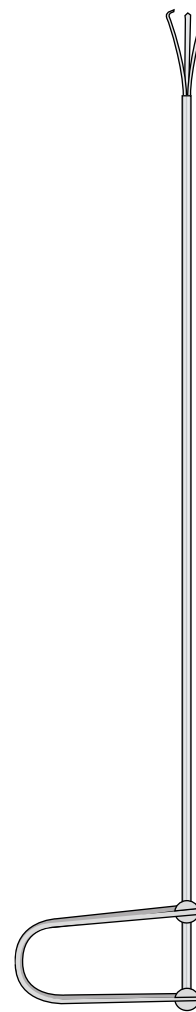

EDER
CA 886-38 38 cm

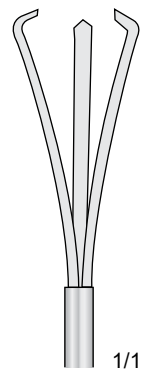

1/1



we take a closer look



Retractors



Retraktoren
Écarteurs
Separadores
Divaricatori

Uncini cutanei - Cutaneous hook - Hauthäkchen - Erignes cutanées - Ganchos cutáneos

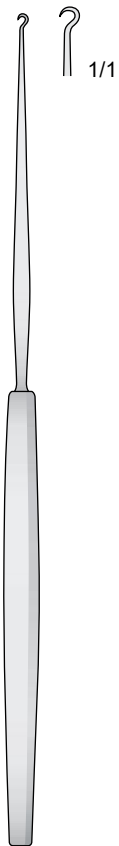

GILLIES
MR 890-18
18 cm

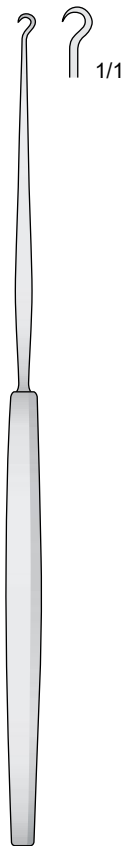

GILLIES
MR 891-18
18 cm

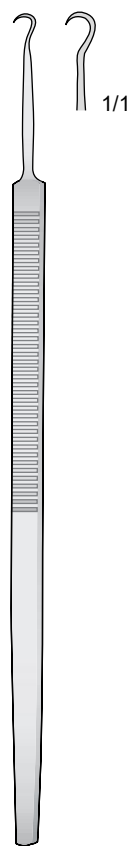

MR 892-16
16 cm

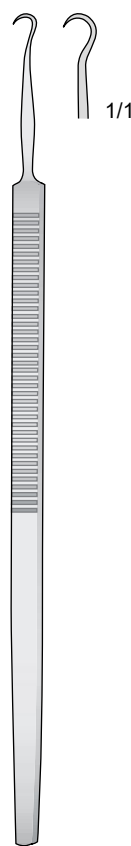

MR 893-16
16 cm

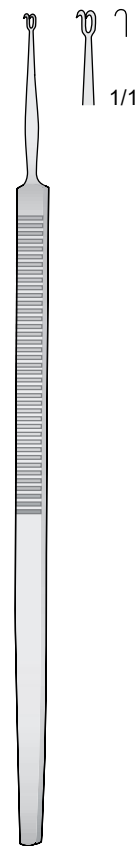

GUTHRIE
MR 894-16
16 cm

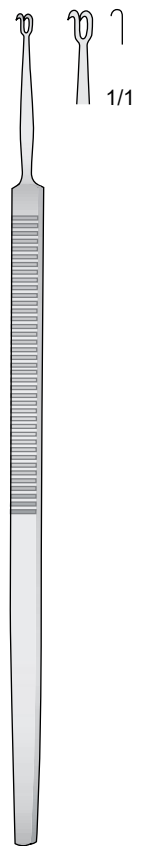

GUTHRIE
MR 895-16
16 cm

Divaricatori
 Retractors
 Wundhaken
 Ecarteurs
 Separadores

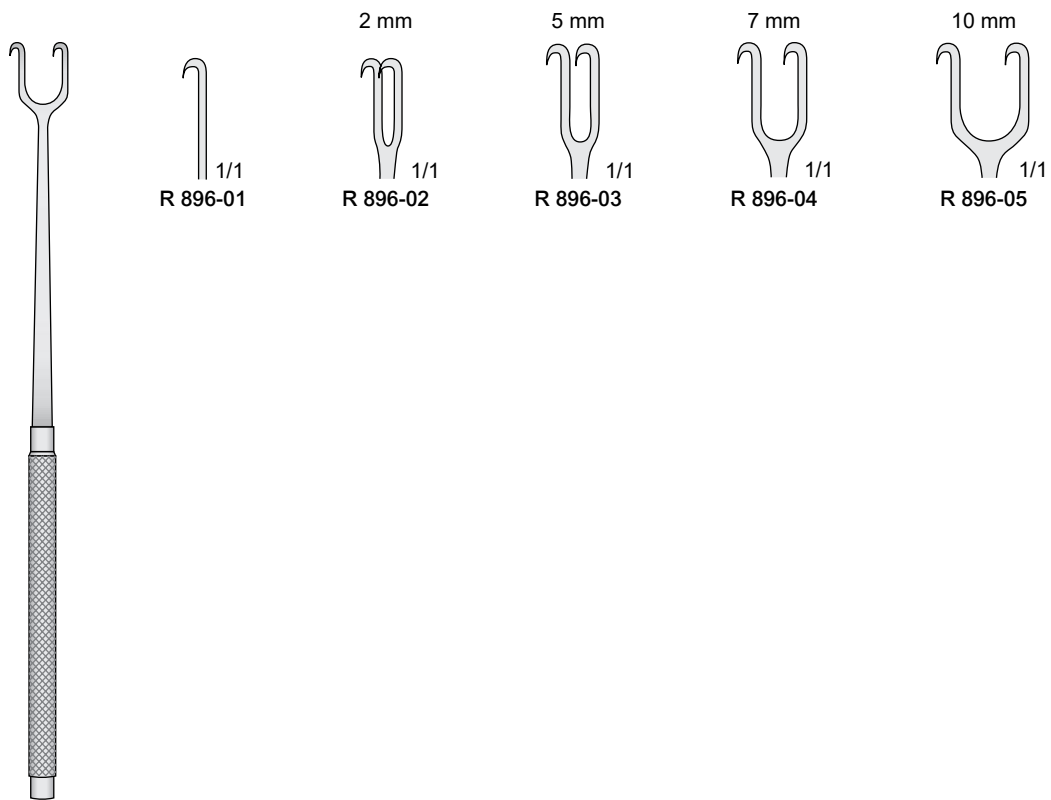

JOSEPH
R 896-01 / R 896-05
 16 cm

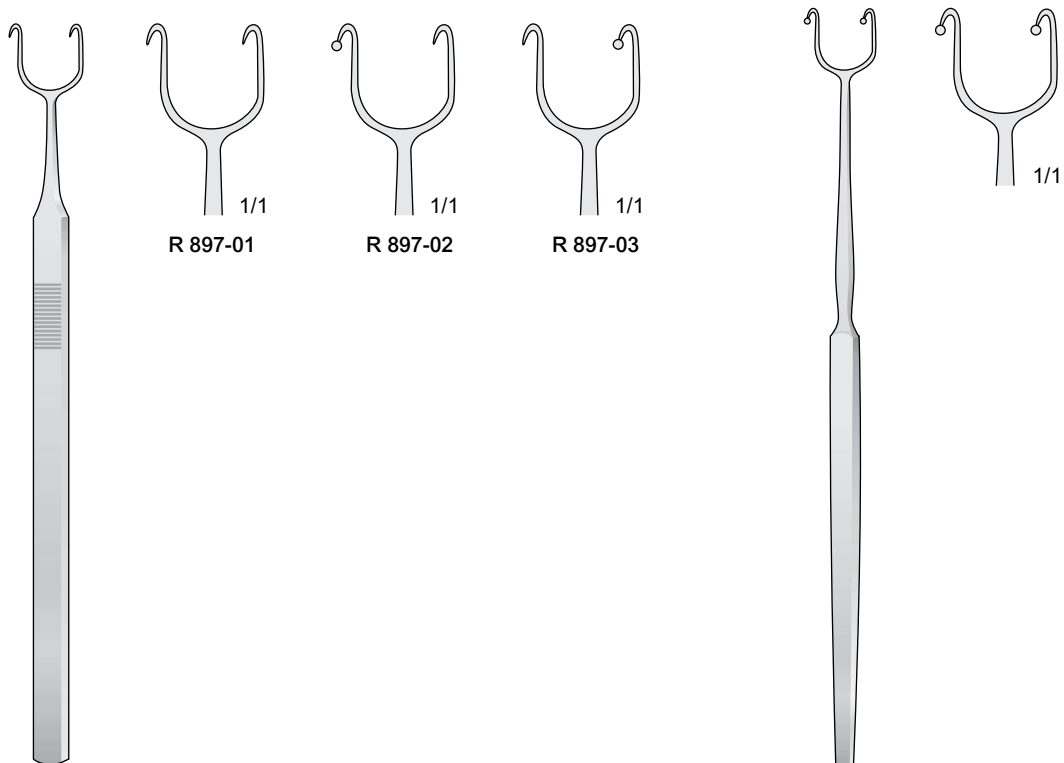

COTTLE
R 897-01 / R 897-03
 15 cm

FOMON
R 898-16 16 cm





1/1
Acuto
Sharp
Spitz
Pointu
Agudo

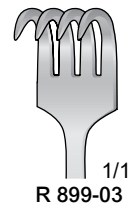
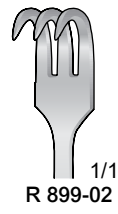
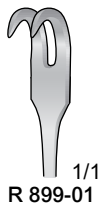

1/1
Smusso
Blunt
Stumpf
Mousse
Romo

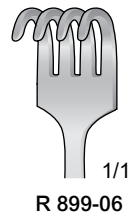
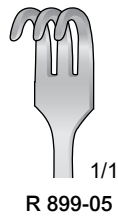

R 899-01 / R 899-06

16 cm

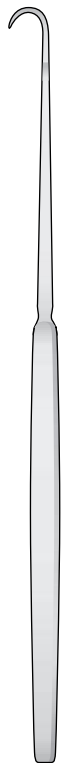

1/1
Acuto
Sharp
Spitz
Pointu
Agudo



1/1
Smusso
Blunt
Stumpf
Mousse
Romo

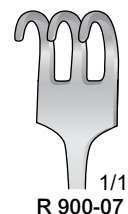
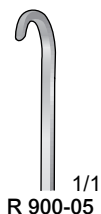

R 900-01 / R 900-08

16 cm

Divaricatori delicati flessibili-acuti
Feine wundhaken flexibel-spitz
Delicate retractors flexible-sharp
Separadores finos flexibles-agudas

Divaricatori delicati flessibili-smussi
Feine wundhaken flexibel-stumpf
Delicate retractors flexible-blunt
Separadores finos flexibles-romas

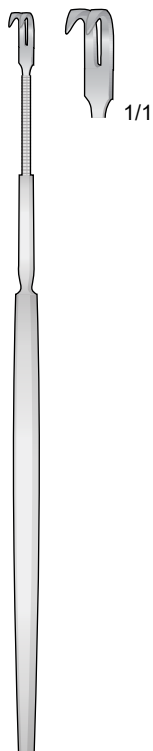

R 901-15
15 cm

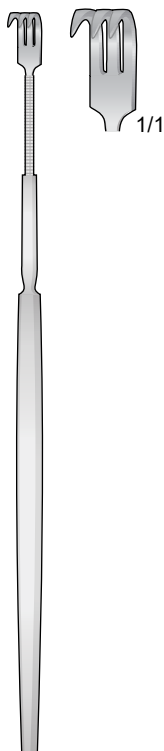

R 902-15
15 cm

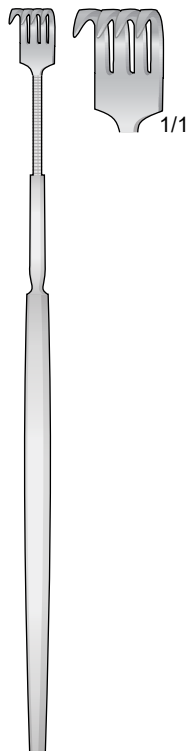

R 903-15
15 cm

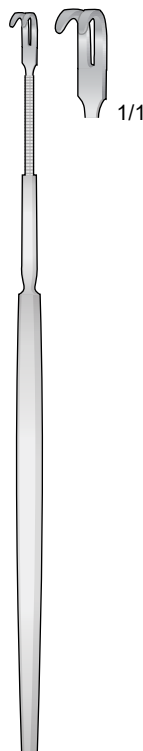

R 904-15
15 cm

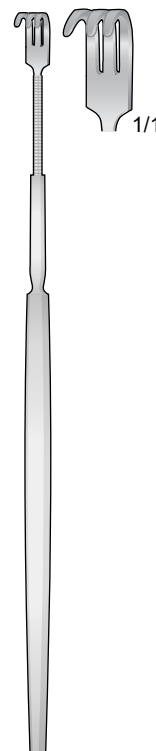

R 905-15
15 cm

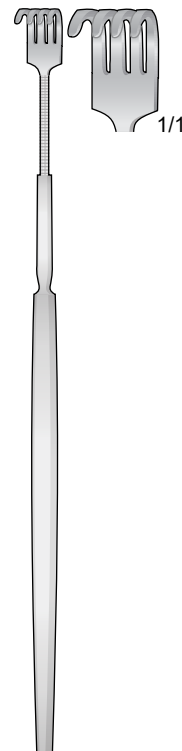

R 906-15
15 cm

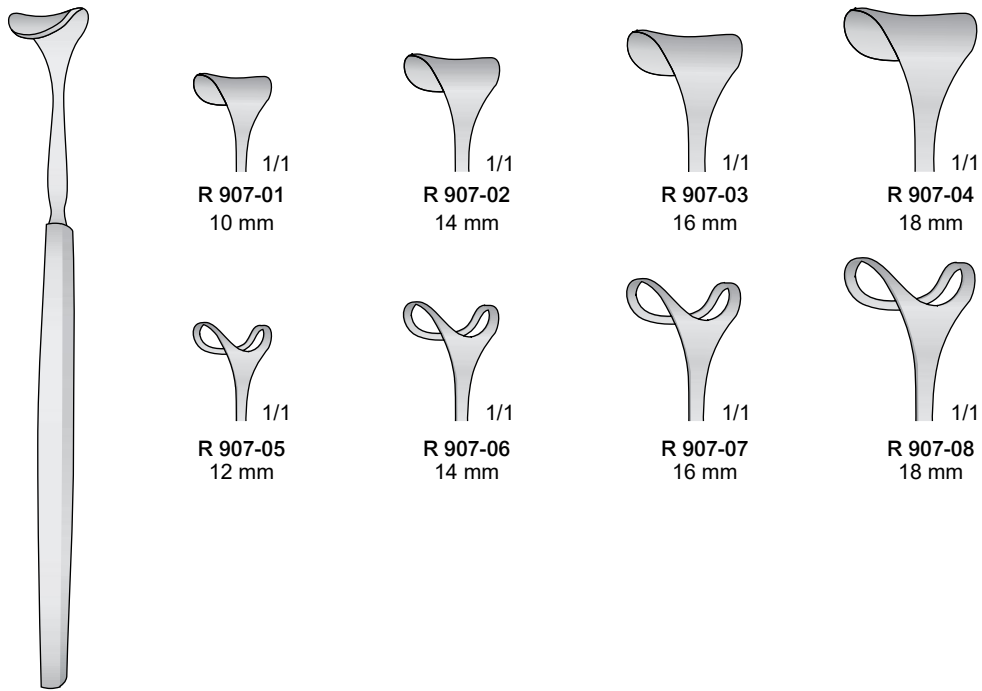

DESMARRES
R 907-01 / R 907-08
14 cm

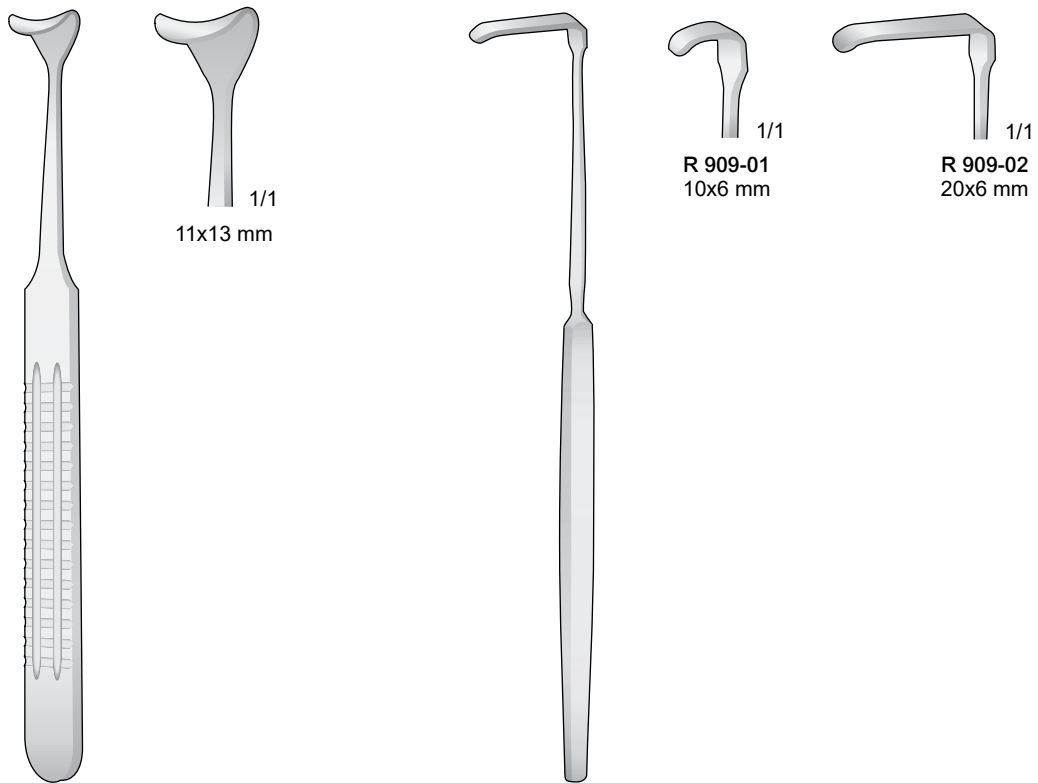

DESMARRES
R 908-16 16 cm

SENN GREEN
R 909-01 / R 909-02
16 cm



LAHEY
R 910-19 19.5 cm

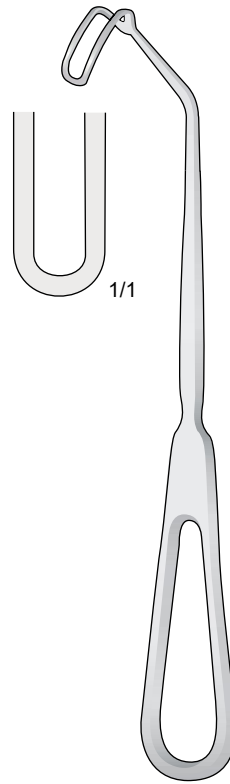

CUSHING
R 911-20 20 cm

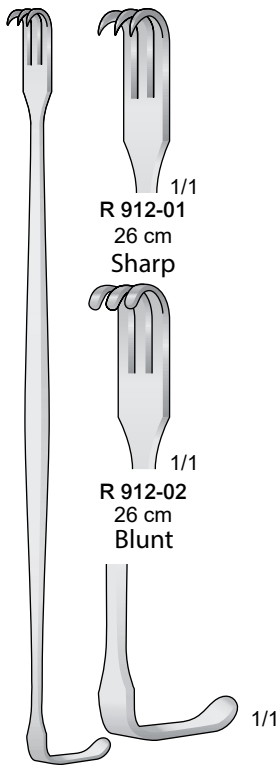
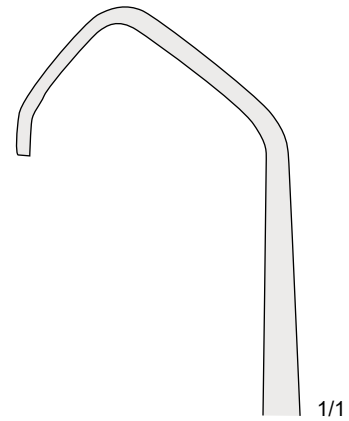

SENN-MILLER
R 912-01 / R 912-02

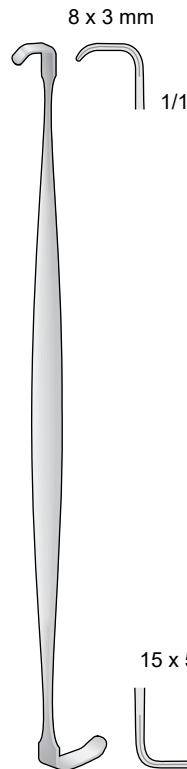

RAGNELL
R 913-14 14 cm

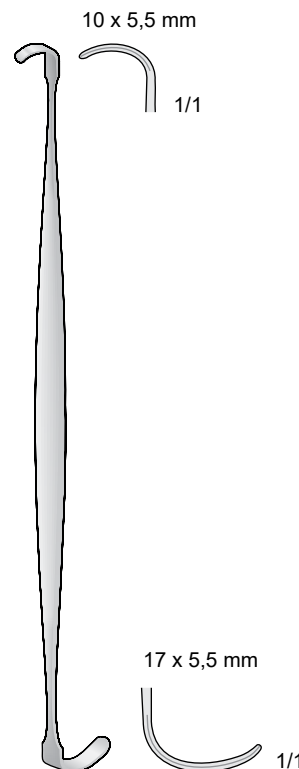

RAGNELL-DAVIS
R 914-14 14 cm

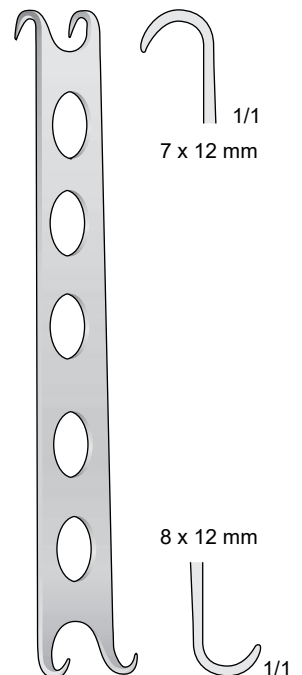

CONVERSE
R 915-12 12 cm

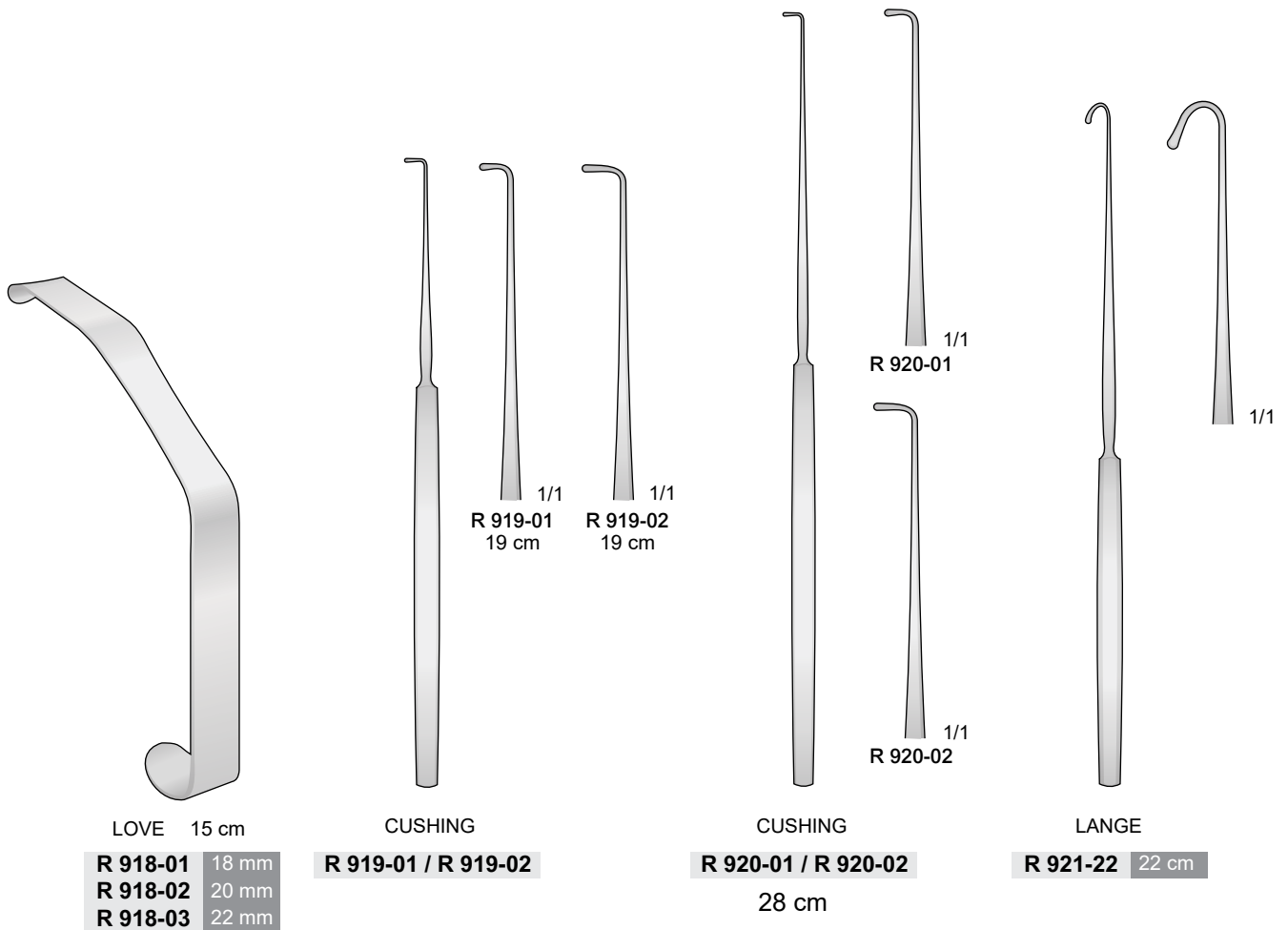
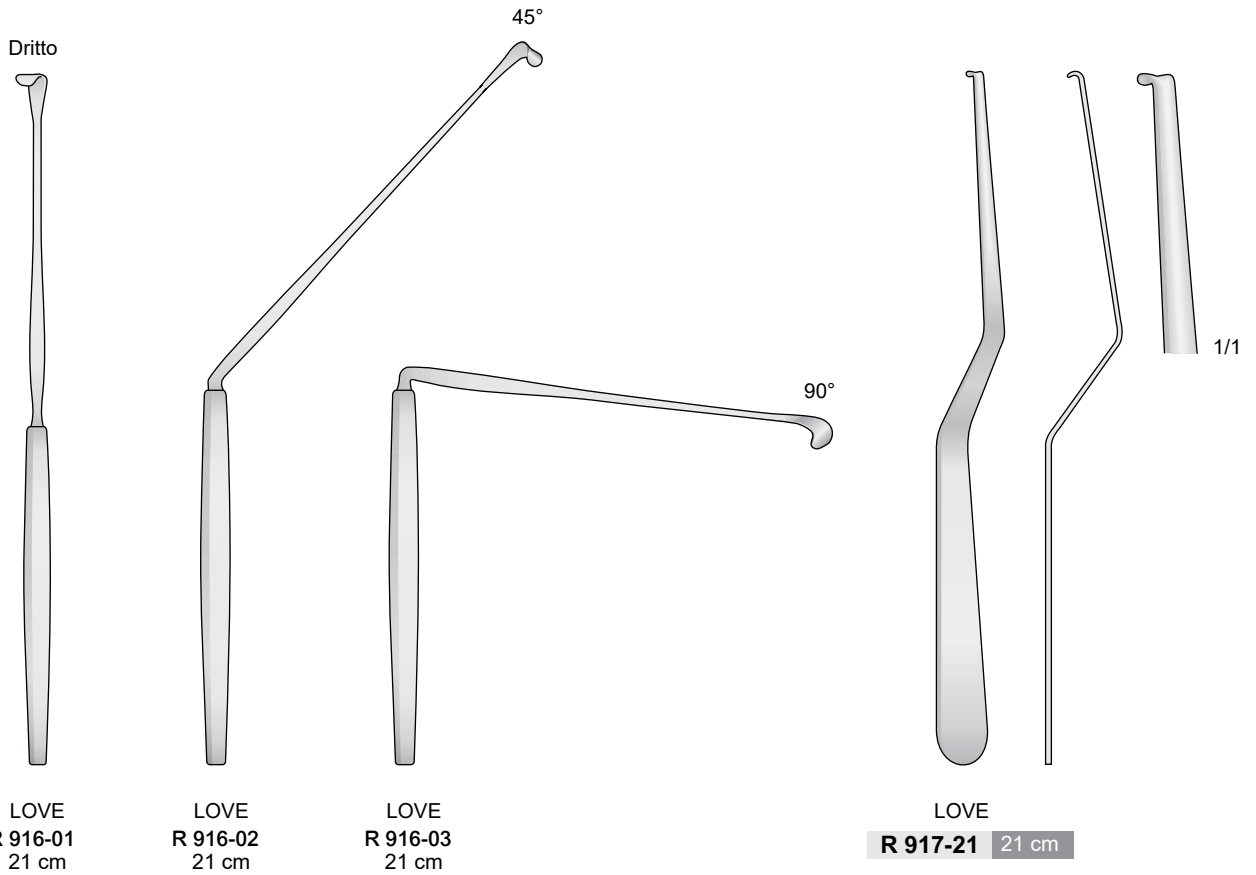

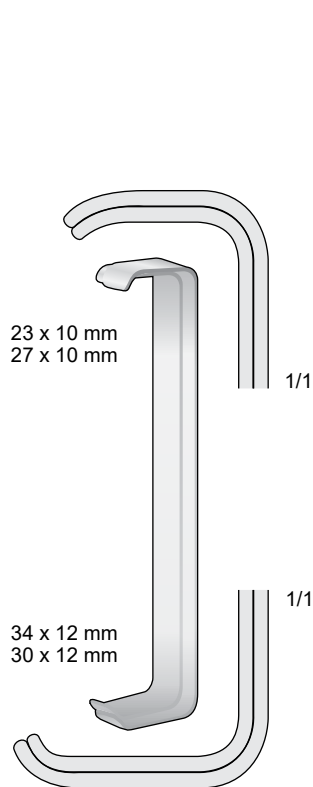

FARABEU
R 922-12 12 cm

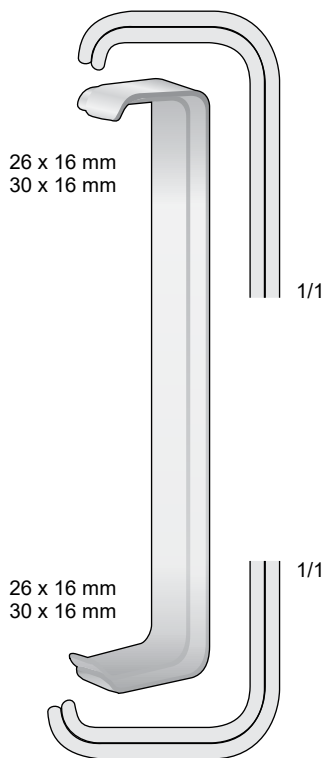

FARABEU
R 923-15 15 cm

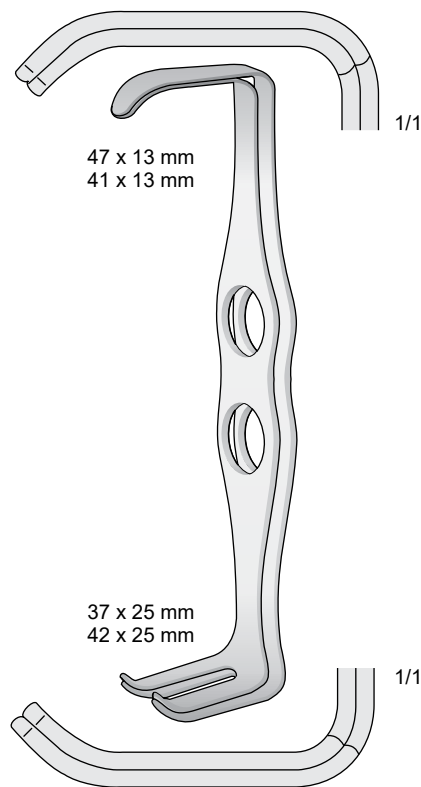

MATHIEU
R 924-20 20 cm

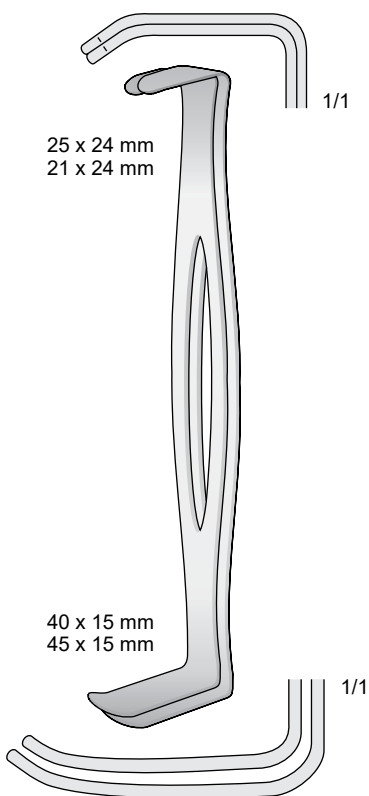

PARKER-LANGENBECK
R 925-21 21 cm

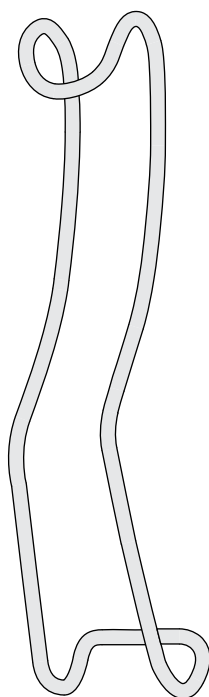

STERNBERG
R 926-16 16 cm

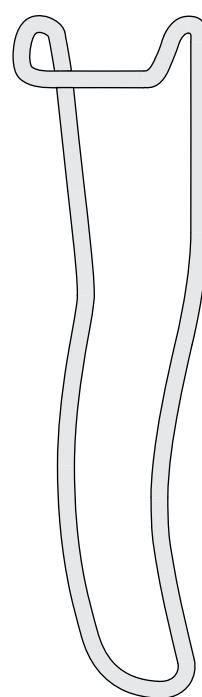

STERNBERG
R 927-16 16 cm

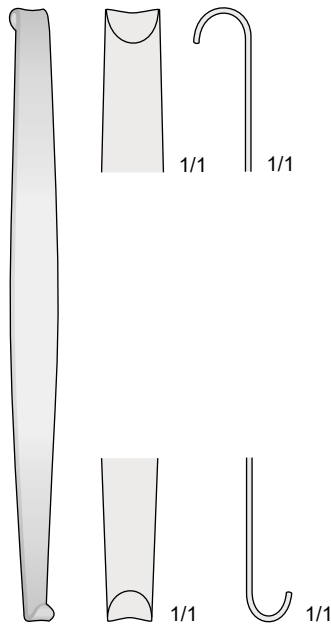

MINI-ROUX
R 928-15 15 cm

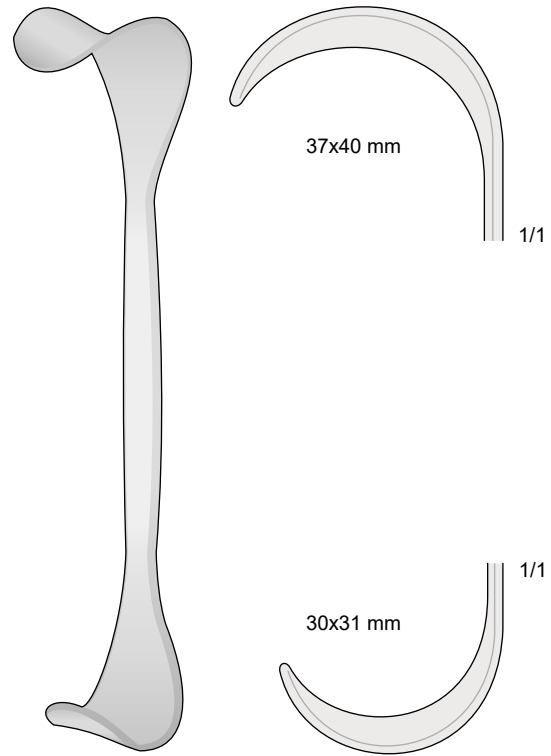

GOELET
R 929-19 19 cm

R 929-19
Set completo
Set complete
Komplettsset
Set complet
Set completo

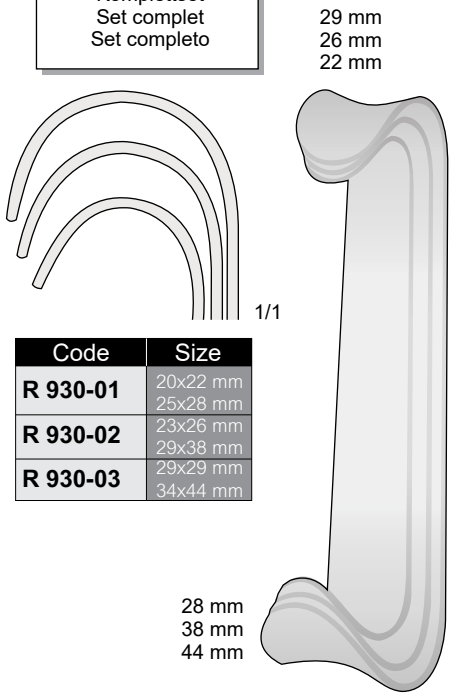

ROUX
R 930-16 16.5 cm

Code	Size
R 930-01	20x22 mm 25x28 mm
R 930-02	23x26 mm 29x38 mm
R 930-03	29x29 mm 34x44 mm

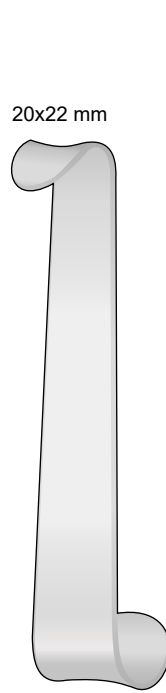

25x28 mm
ROUX-MAGNUS
R 931-15 15 cm



29x38 mm
ROUX-MAGNUS
R 932-16 16 cm

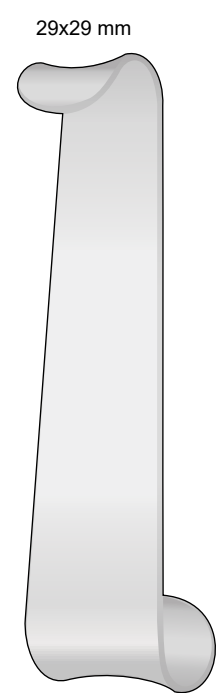

34x44 mm
ROUX-MAGNUS
R 933-17 17 cm

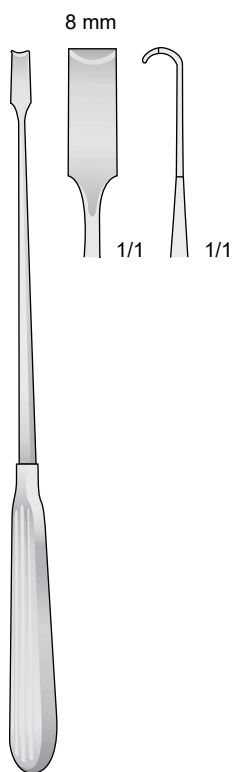

SCOVILLE
R 934-23 23 cm

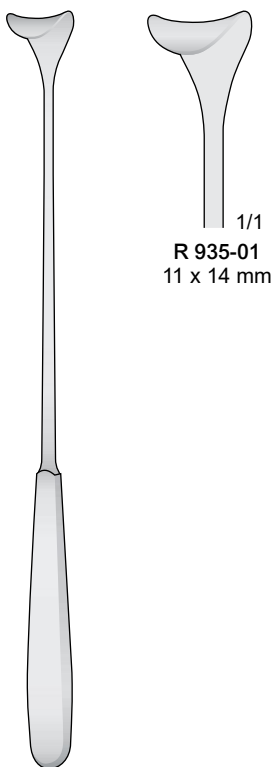

CUSHING
R 935-01 / R 935-03
 25 cm

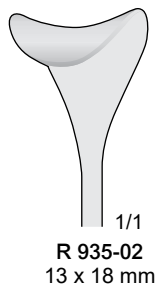

R 935-02
 13 x 18 mm

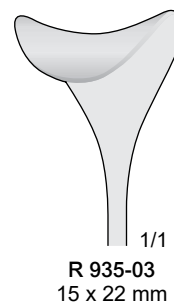

R 935-03
 15 x 22 mm

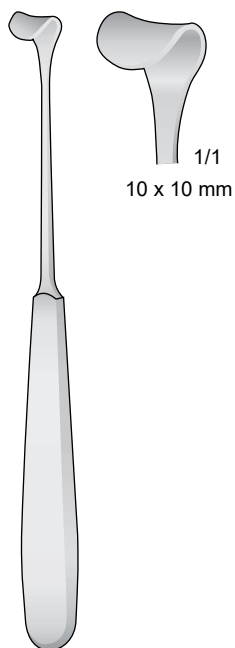

CUSHING-KOCHER
R 936-18 18 cm

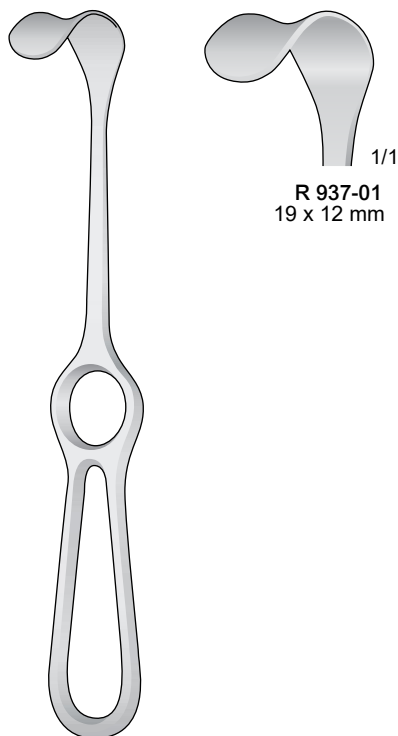

R 937-01
 19 x 12 mm



R 937-02
 21 x 14 mm

KOCHER
R 937-01 / R 937-02
 20.5 cm

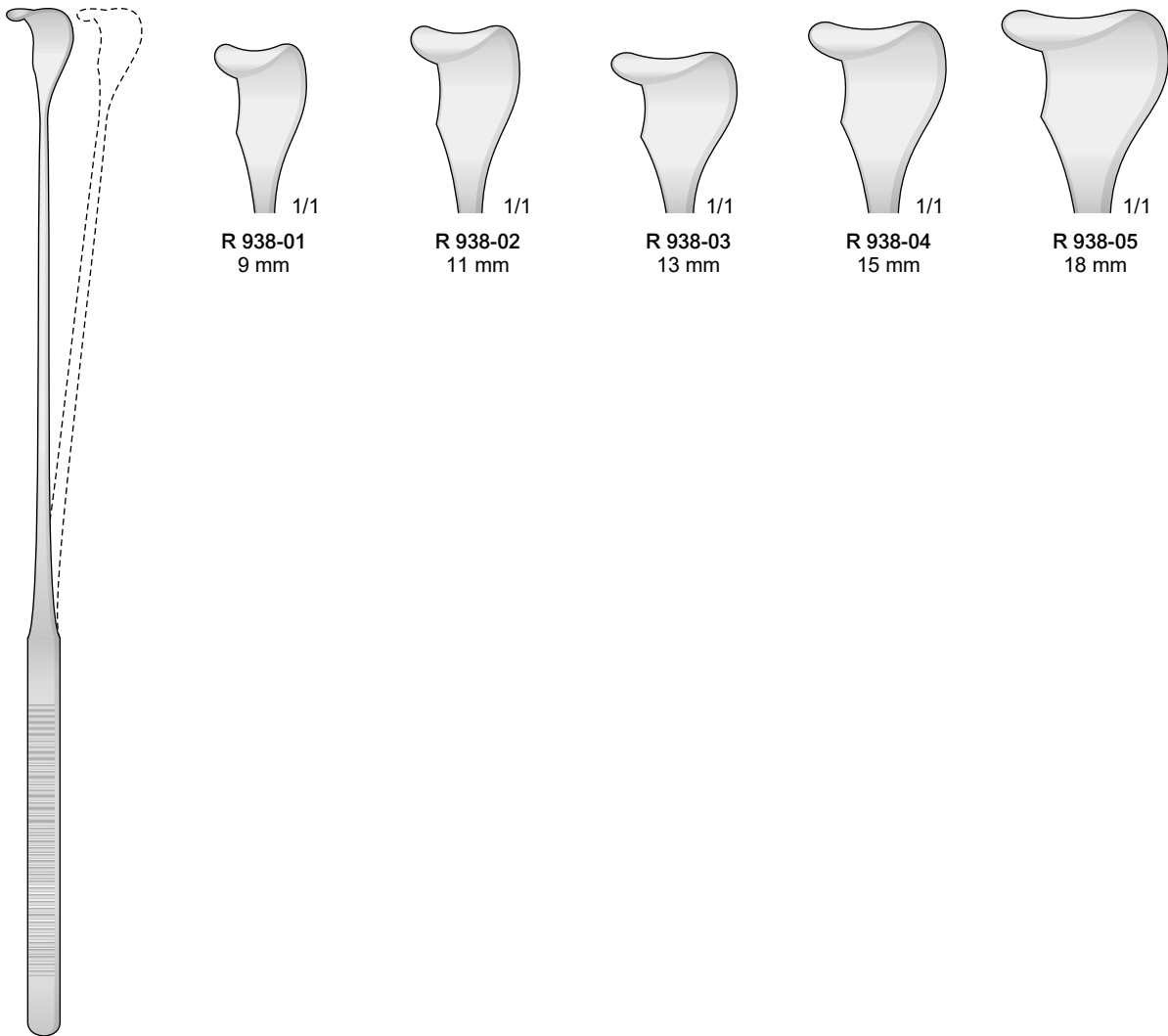

R 938-01
9 mm

R 938-02
11 mm

R 938-03
13 mm

R 938-04
15 mm

R 938-05
18 mm

GIL-VERNET

R 938-01 / R 938-05

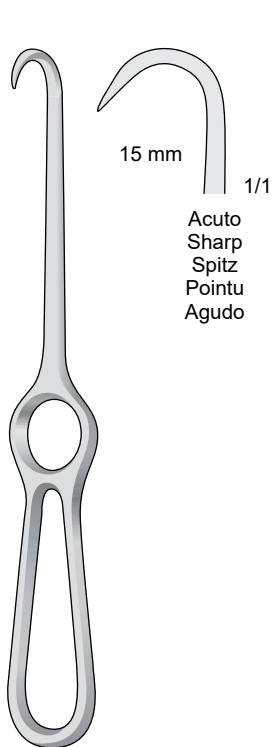

15 mm 1/1
 Acuto
 Sharp
 Spitz
 Pointu
 Agudo

KOCHER
R 939-20 20.5 cm

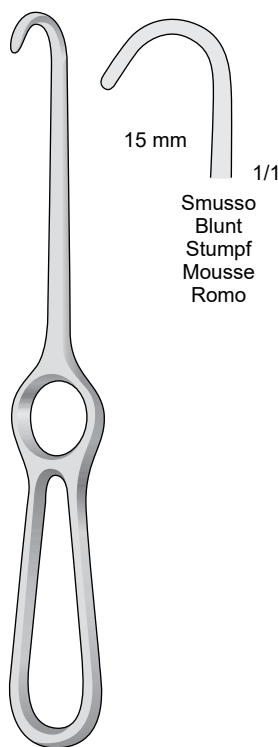

15 mm 1/1
 Smusso
 Blunt
 Stumpf
 Mousse
 Romo

KOCHER
R 940-22 22 cm

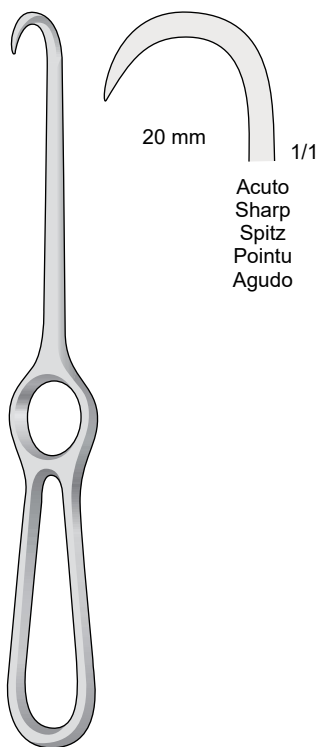

20 mm 1/1
 Acuto
 Sharp
 Spitz
 Pointu
 Agudo

VOLKMANN
R 941-22 22 cm

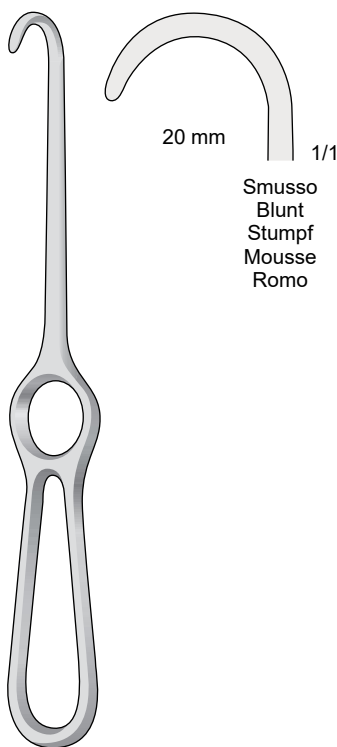

20 mm 1/1
 Smusso
 Blunt
 Stumpf
 Mousse
 Romo

VOLKMANN
R 942-22 22 cm



25 mm 1/1
 Acuto
 Sharp
 Spitz
 Pointu
 Agudo

R 943-24 24.5 cm

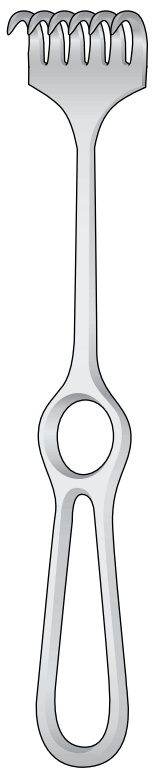

VOLKMANN
R 944-01 / R 944-08

22 cm

Acuto
Sharp
Spitz
Pointu
Agudo

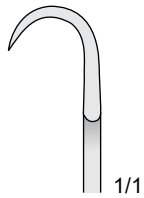

1/1

Smusso
Blunt
Stumpf
Mousse
Romo

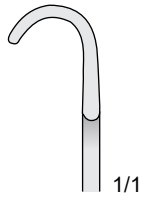

1/1



R 944-01
9 x 8 mm



R 944-02
9 x 13 mm



R 944-03
9 x 19 mm

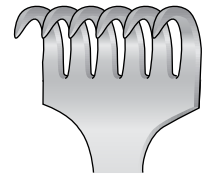

R 944-04
9 x 29 mm



R 944-05
8 x 8 mm



R 944-06
8 x 13 mm



R 944-07
8 x 19 mm

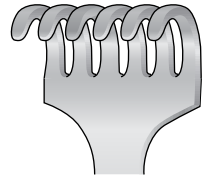

R 944-08
8 x 29 mm

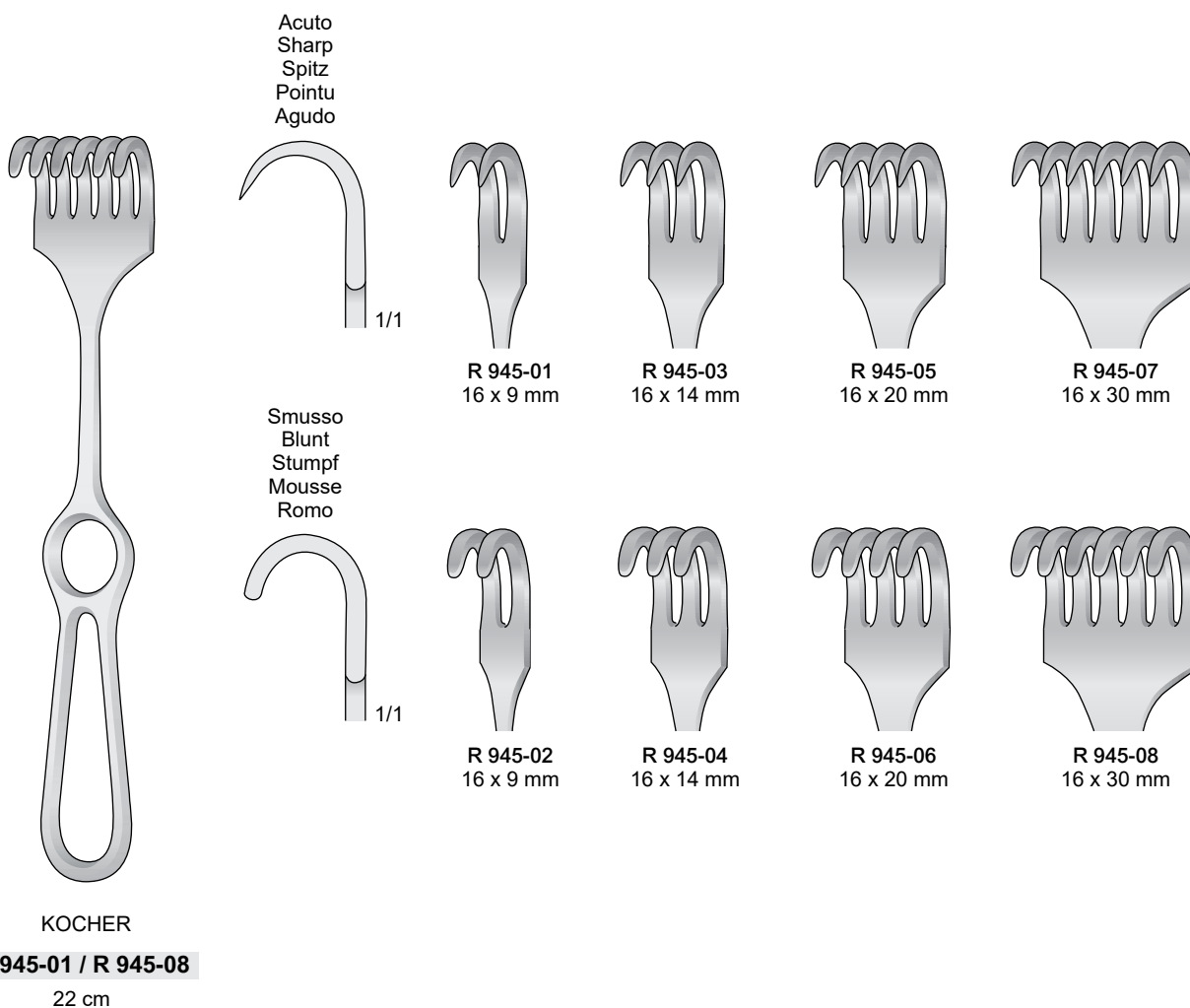

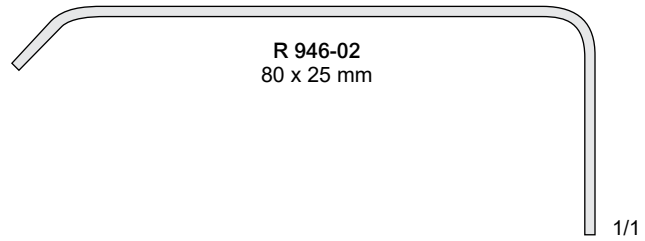
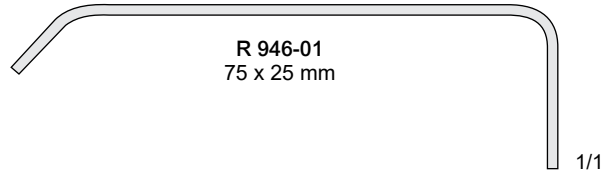
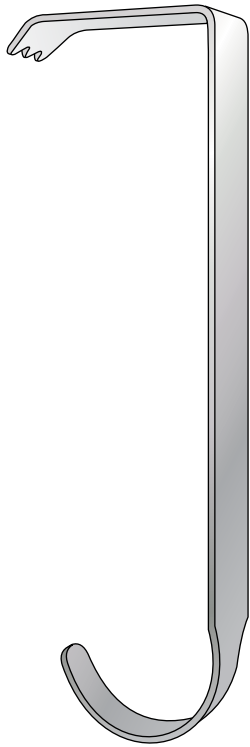

HIBBS

R 946-01 / R 946-02

24 cm

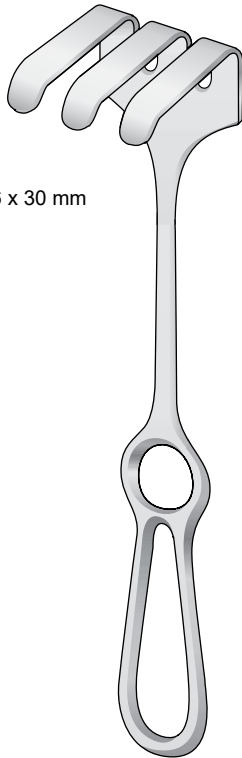

36 x 30 mm

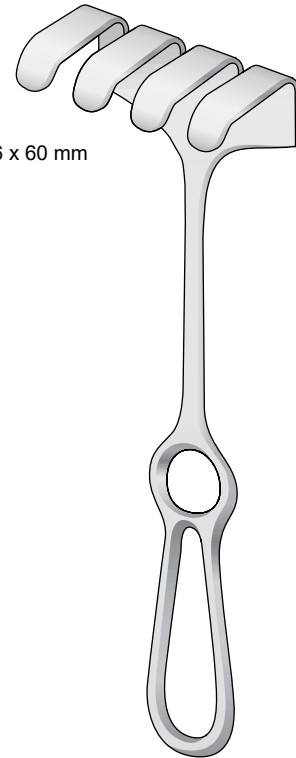
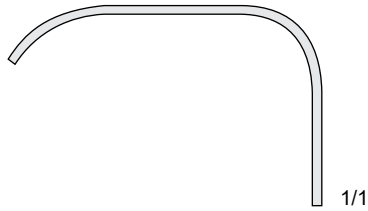

36 x 60 mm

OLLIER

R 947-22 22.5 cm

OLLIER

R 948-22 22.5 cm

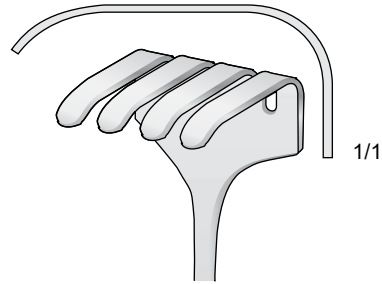

R 949-01
40 x 40 mm

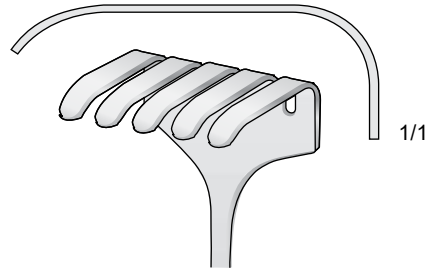

R 949-02
45 x 50 mm

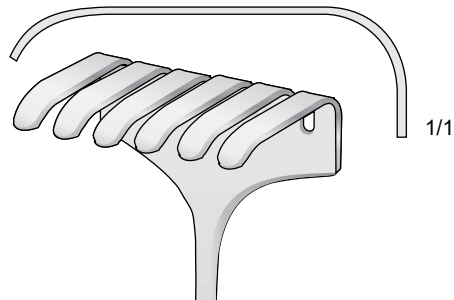

R 949-03
50 x 60 mm

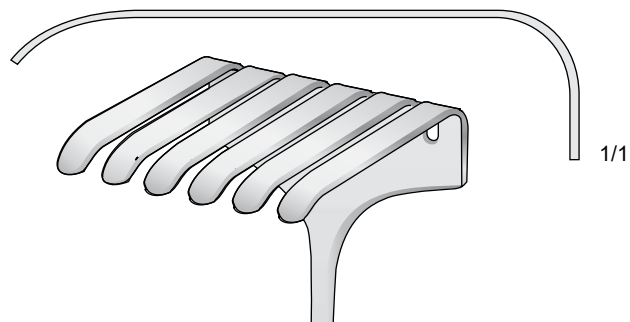

R 949-04
70 x 70 mm

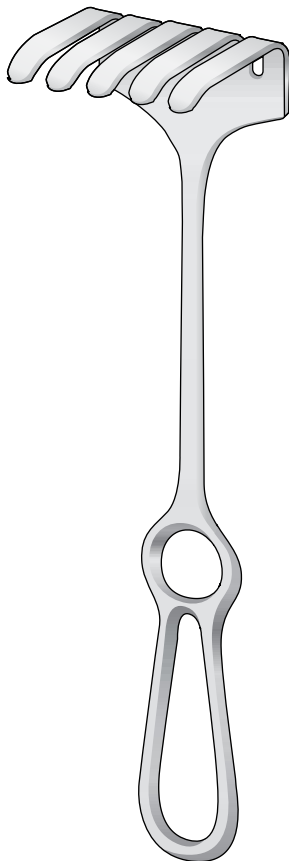

ISRAEL
R 949-01 / R 949-04
25 cm

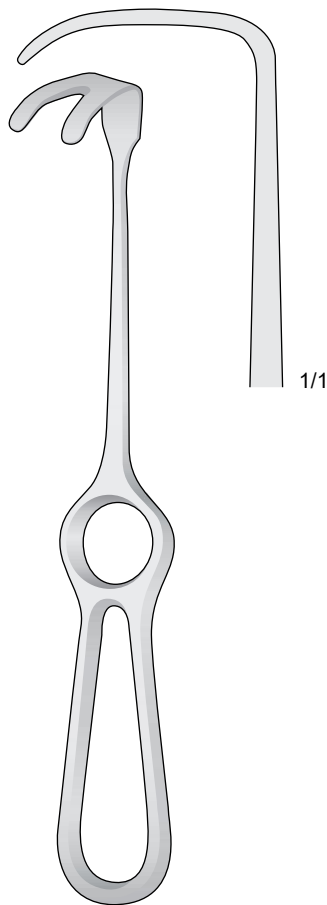

WASSMUND
R 950-22 22 cm

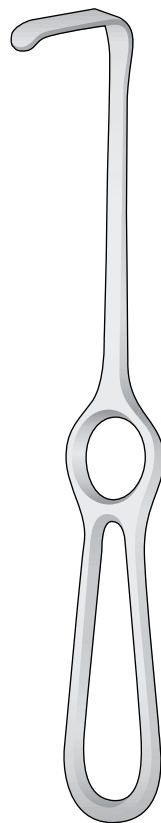

LANGENBECK
R 951-01 / R 951-05
21 cm

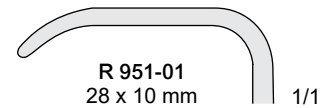

R 951-01
28 x 10 mm 1/1

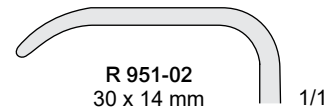

R 951-02
30 x 14 mm 1/1

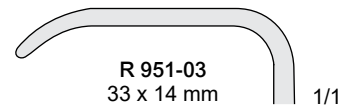

R 951-03
33 x 14 mm 1/1

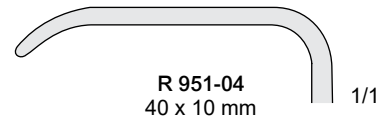

R 951-04
40 x 10 mm 1/1

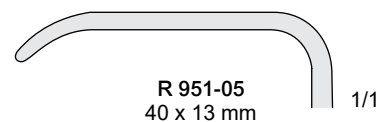

R 951-05
40 x 13 mm 1/1

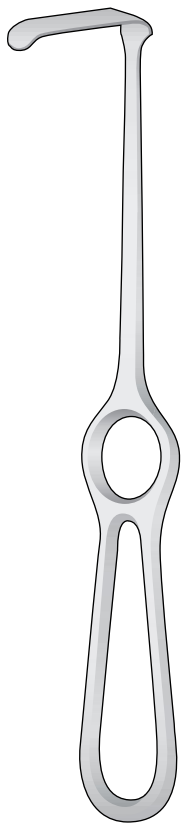

KOCHER-LANGENBECK
R 952-01 / R 952-09
21.5 cm

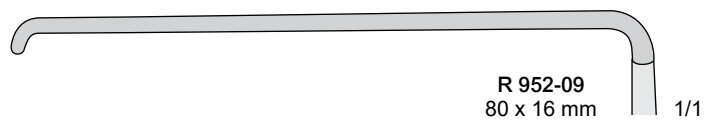
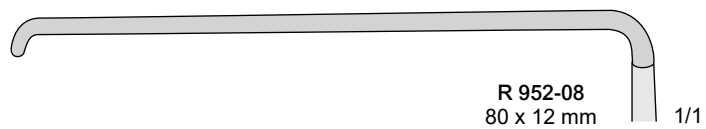
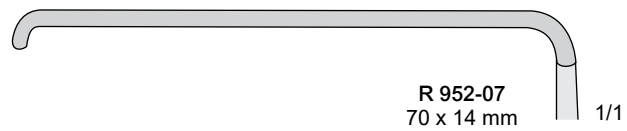
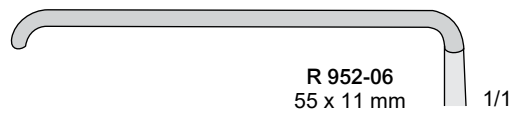
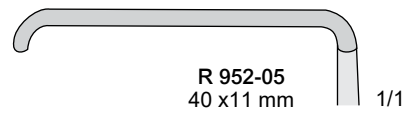
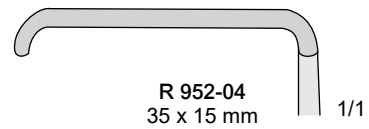
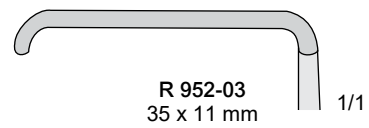
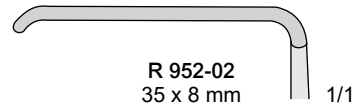
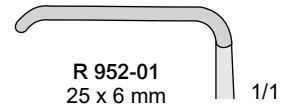

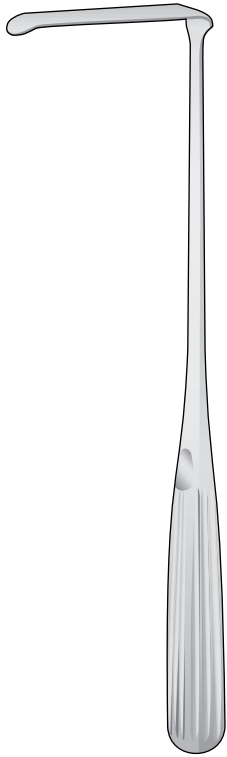

SAUERBRUCH
R 953-01 / R 953-03
22.5 cm

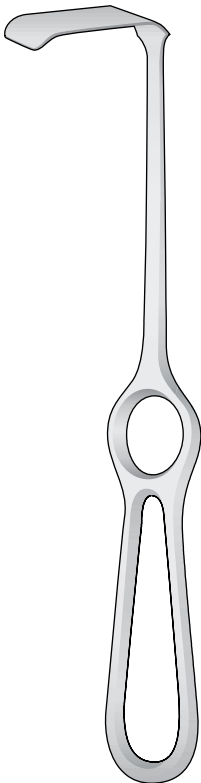
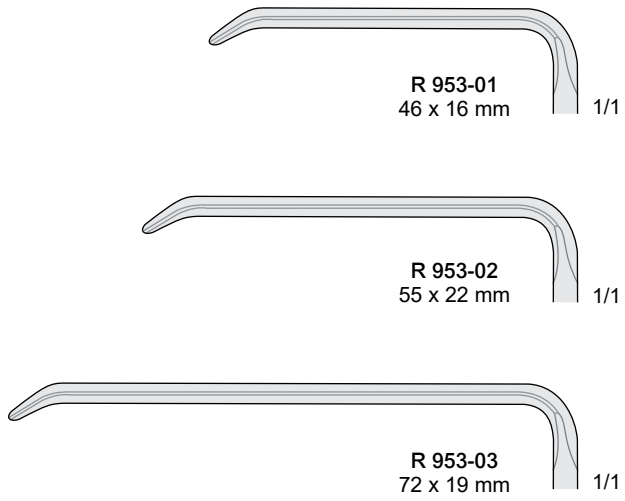

KOCHER
R 954-01 / R 954-05
23 cm

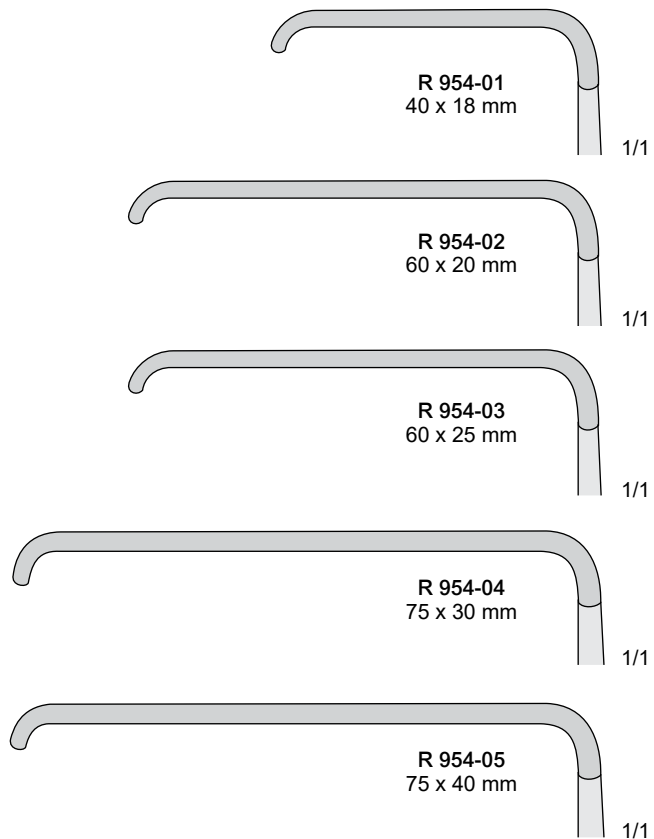

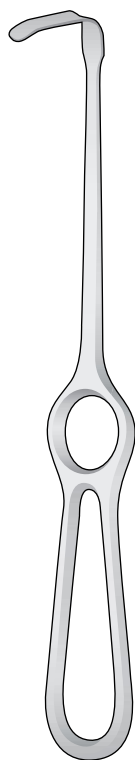

OBWEGESER
R 955-01 / R 955-06
 22 cm

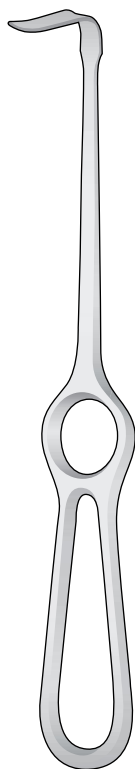
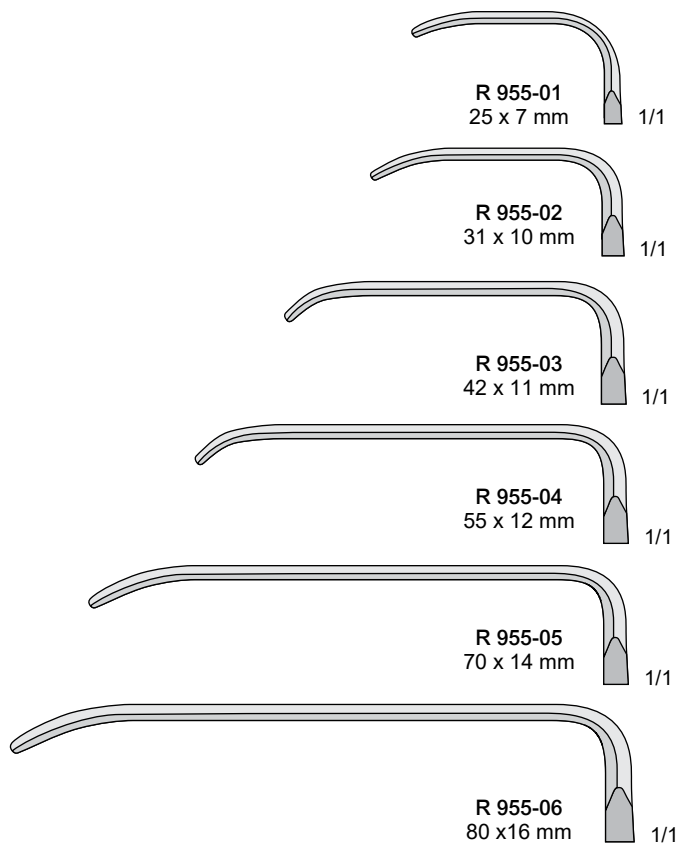

OBWEGESER
R 956-01 / R 956-06
 22 cm

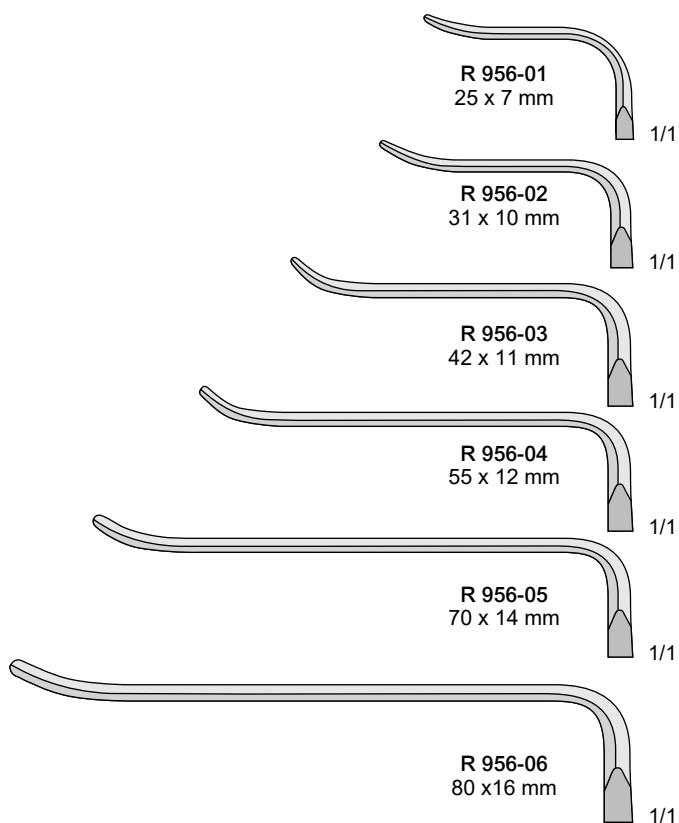

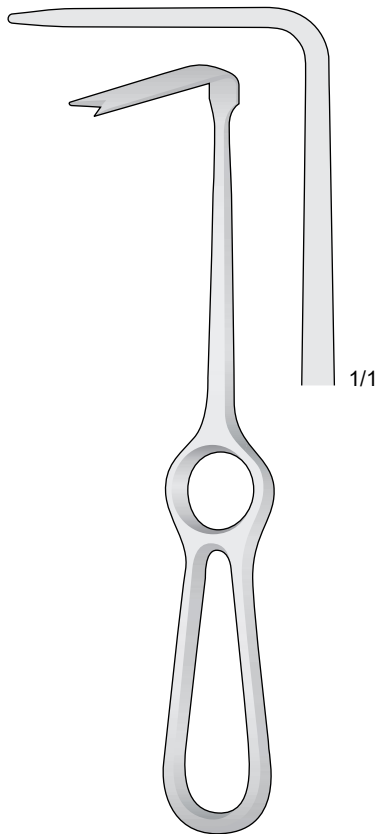
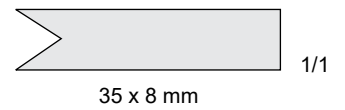
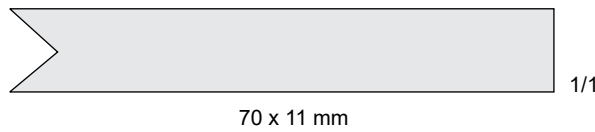
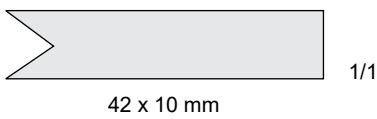

OBWEGESER
R 957-21 21.5 cm

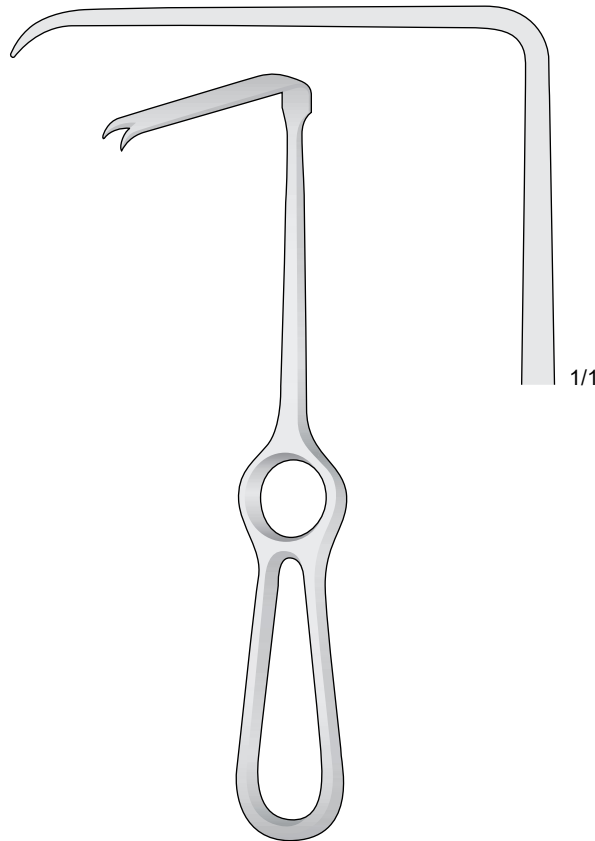

R 958-22 22 cm

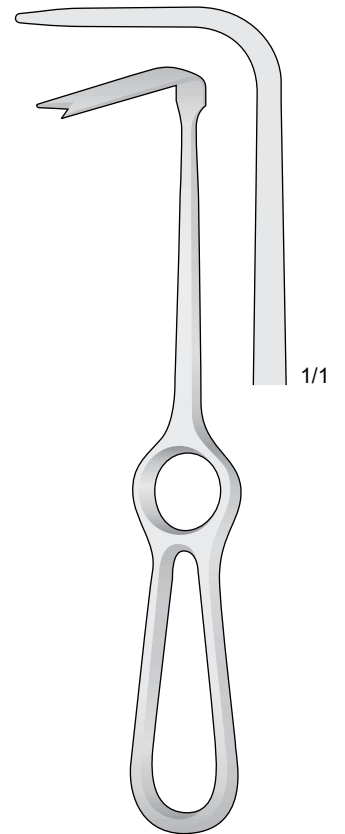

R 959-21 21.5 cm

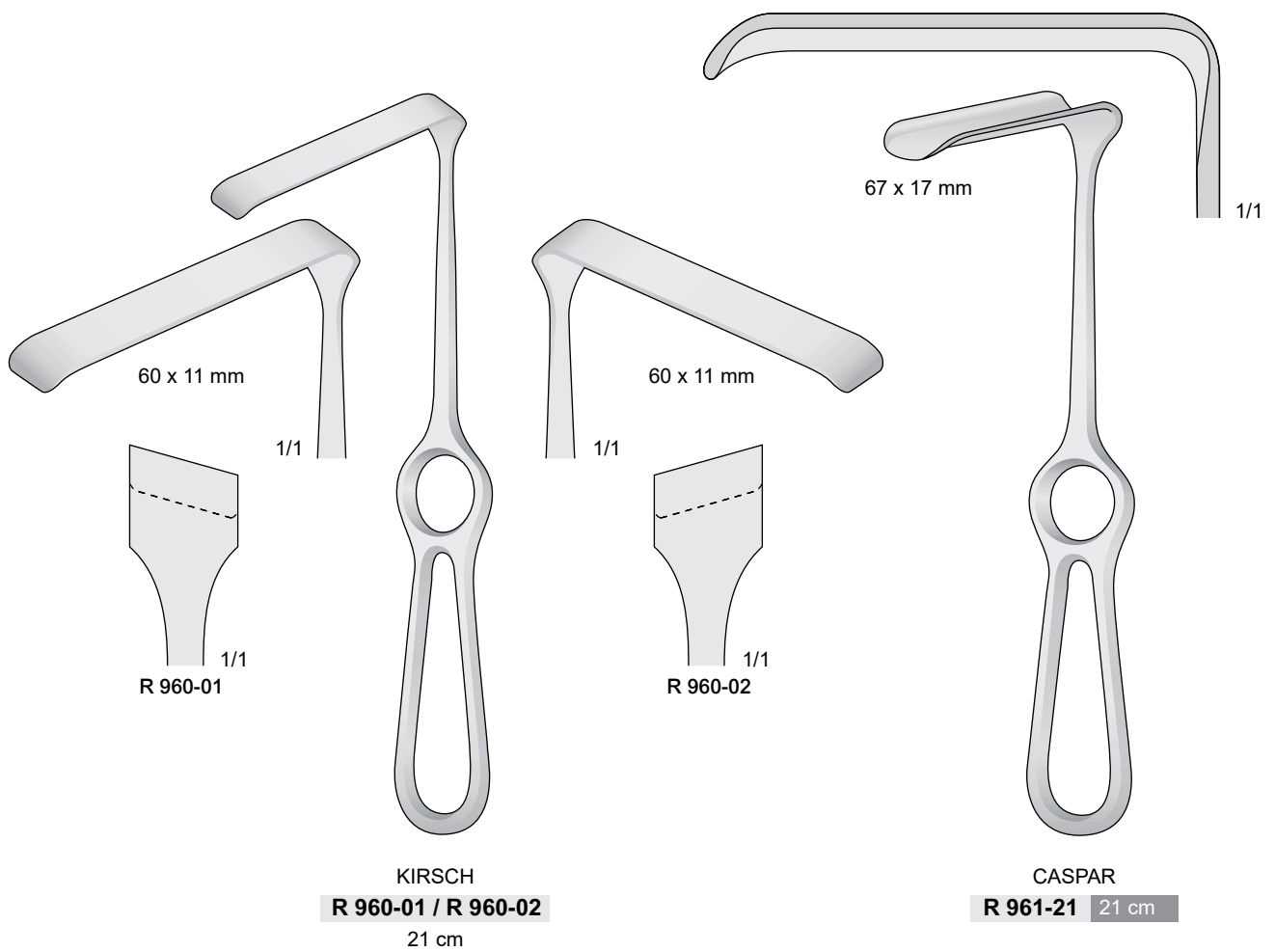

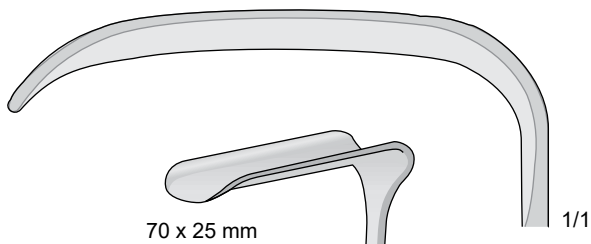

70 x 25 mm

1/1

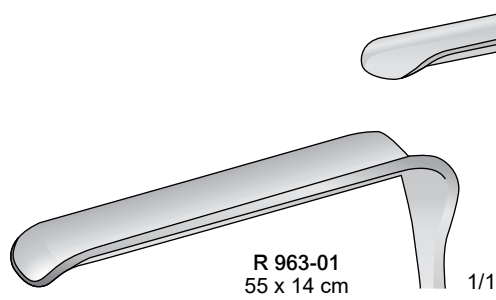

R 963-01
55 x 14 cm

1/1

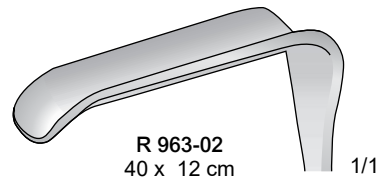

R 963-02
40 x 12 cm

1/1



KOCHER

R 962-24 24 cm

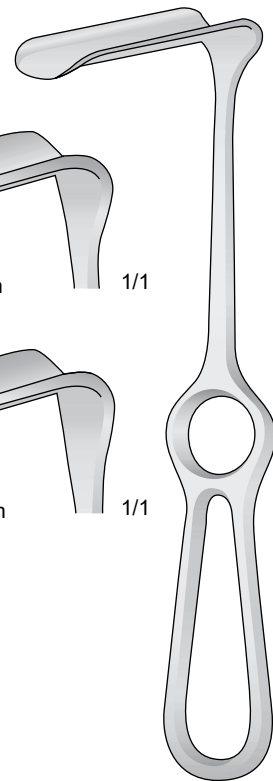

DOCKHORN

R 963-01 / R 963-02
21 cm

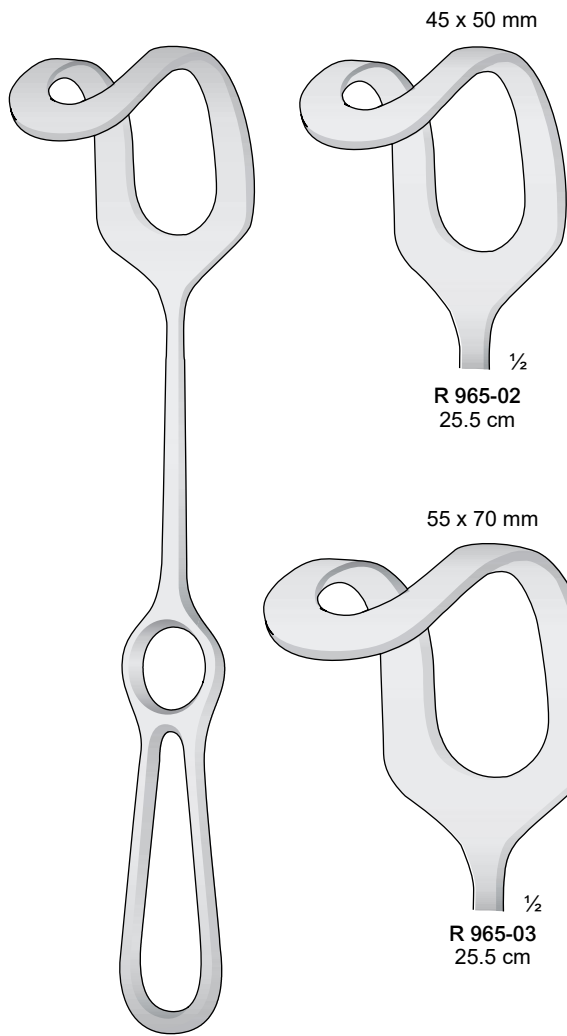
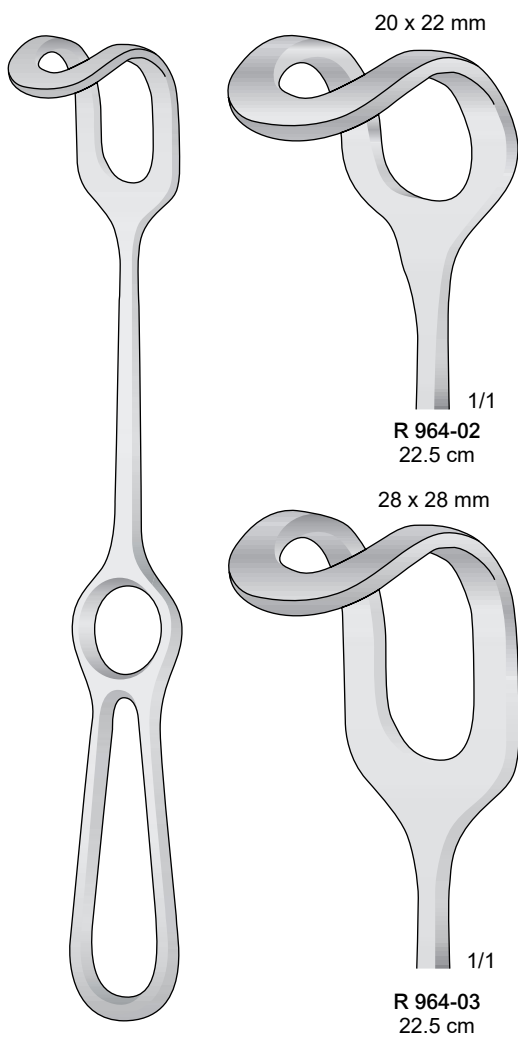
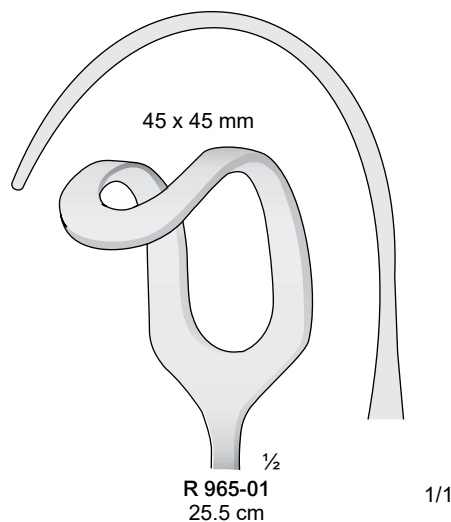
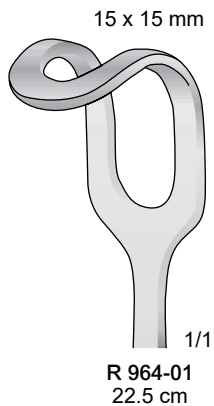

MIDDELDORPF
R 964-01 / R 964-03
 22.5 cm

MIDDELDORPF
R 965-01 / R 965-03
 25.5 cm

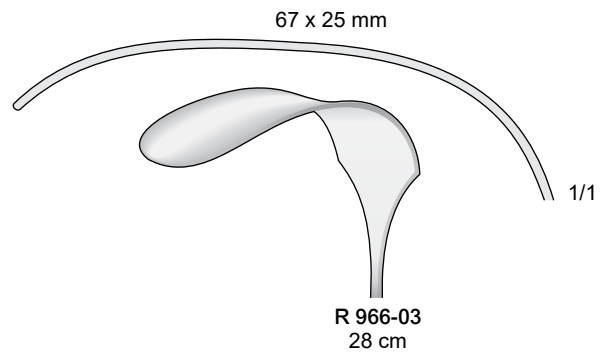
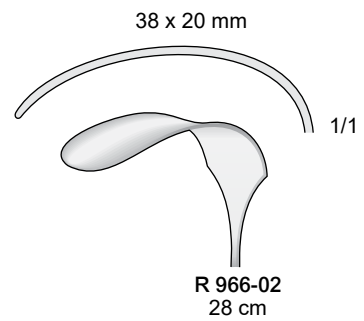
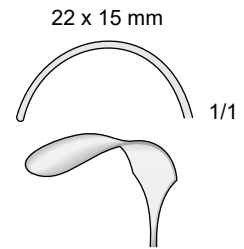
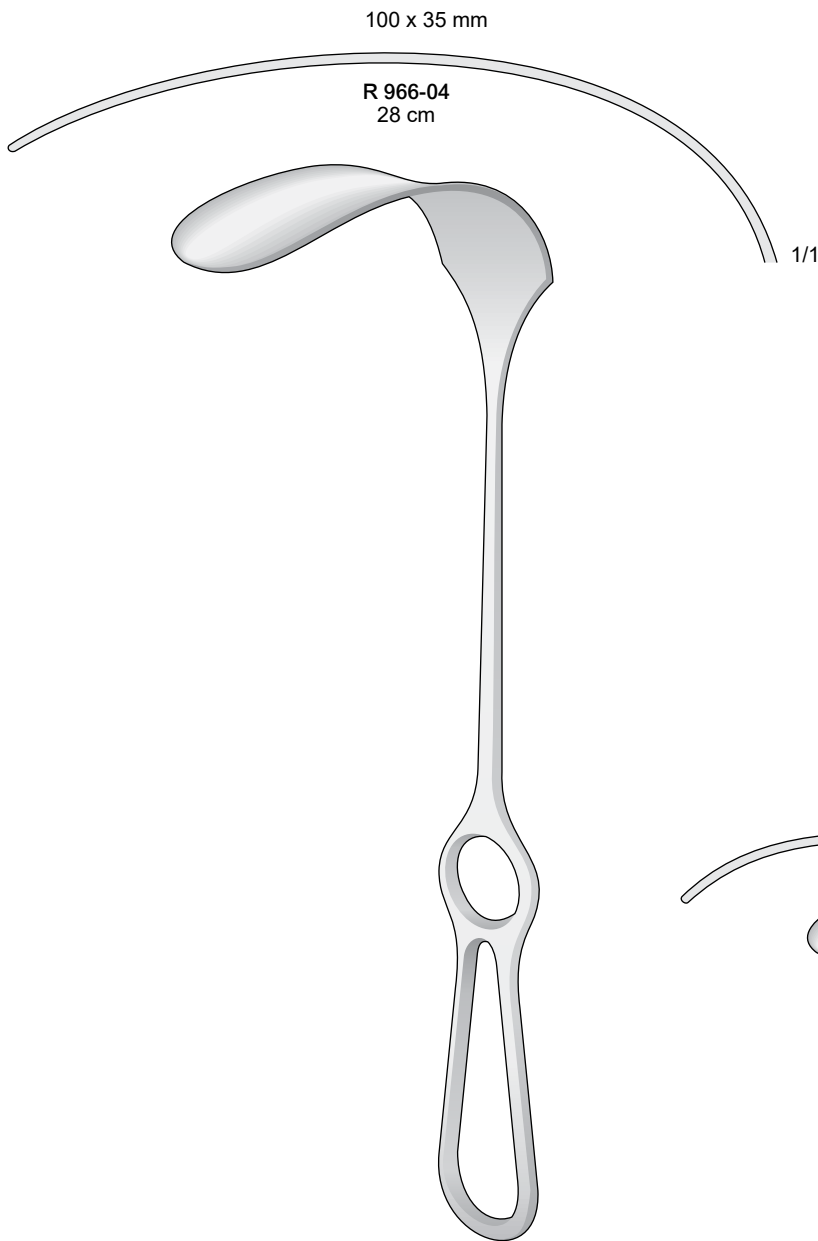

KOCHER
R 966-01 / R 966-04
28 cm

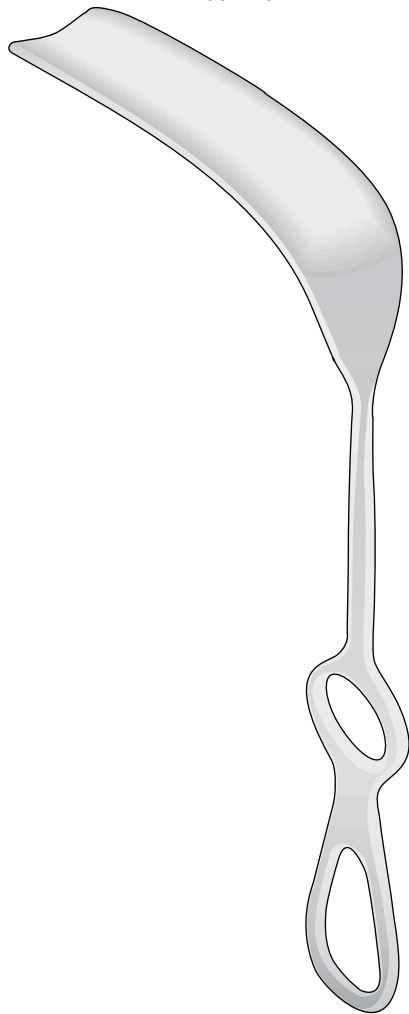
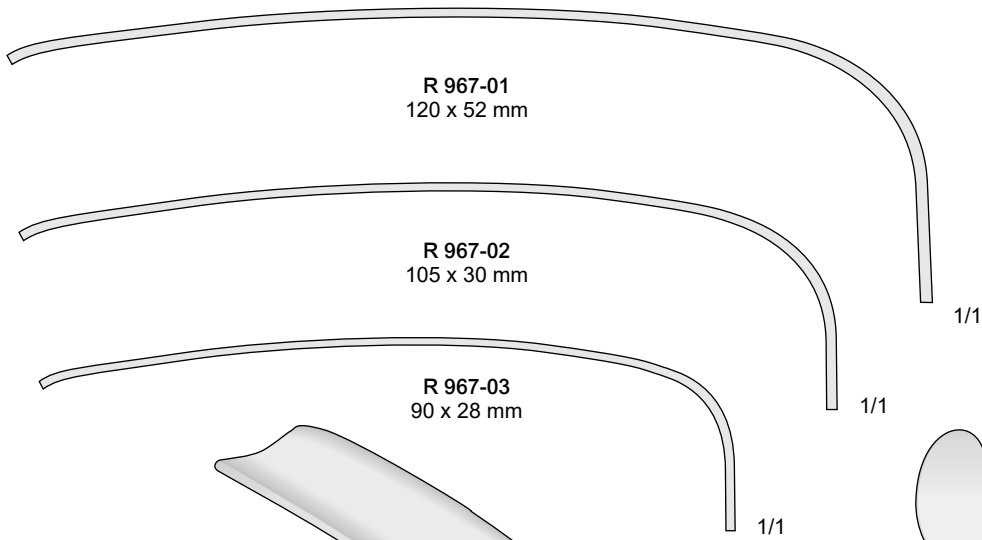

DOYEN-STILLE
R 967-01 / R 967-03
22 cm



DOYEN
R 968-25 25 cm

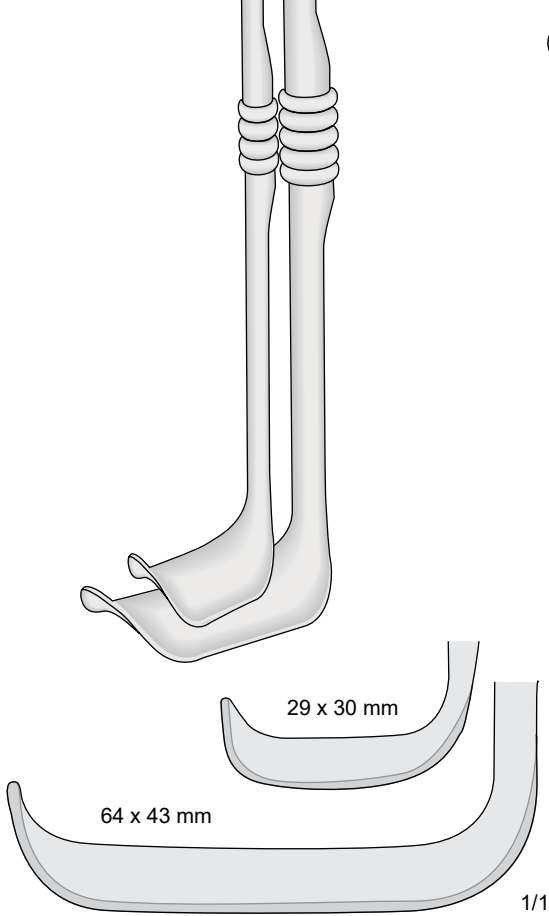
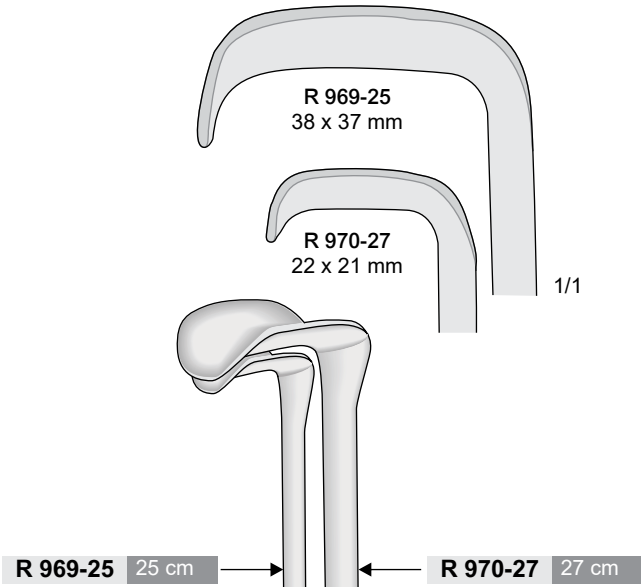

RICHARDSON-EASTMAN
R 971-01
Set 2 pezzi

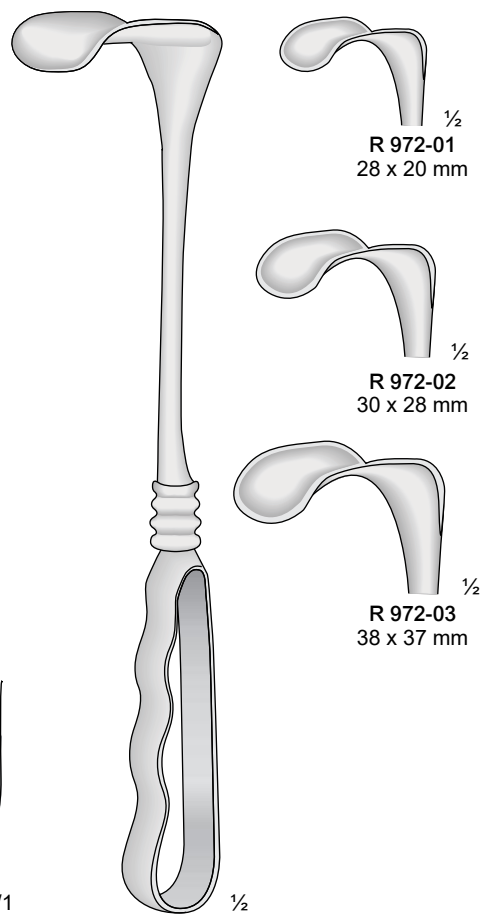

RICHARDSON
R 972-01 / R 972-03
24 cm

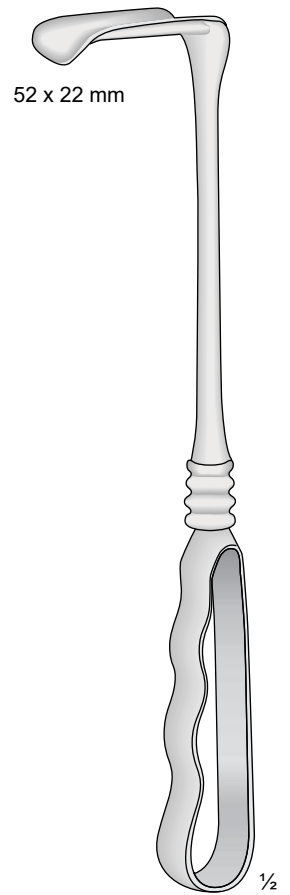

RICHARDSON
R 973-24 24 cm

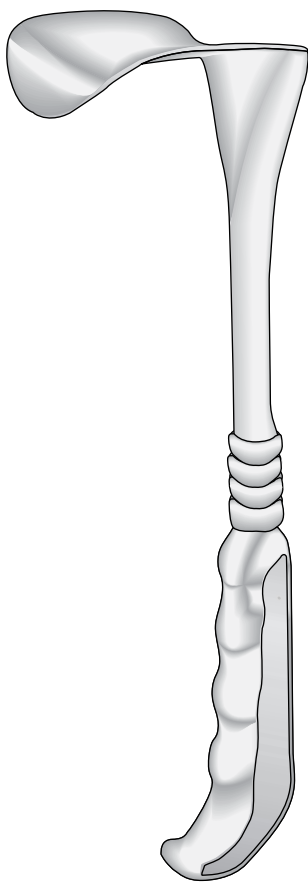

KELLY
R 974-01 / R 974-04
26 cm

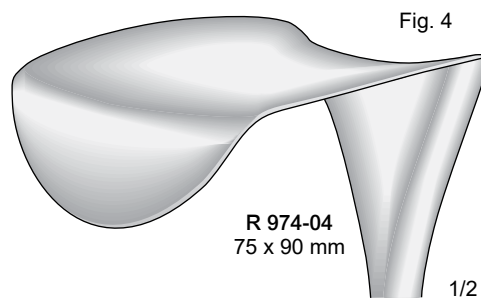
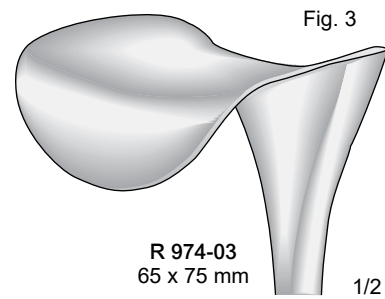
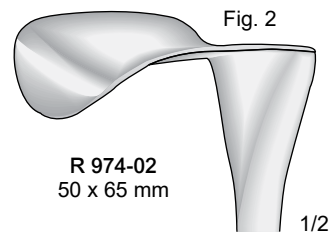
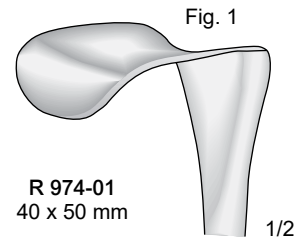

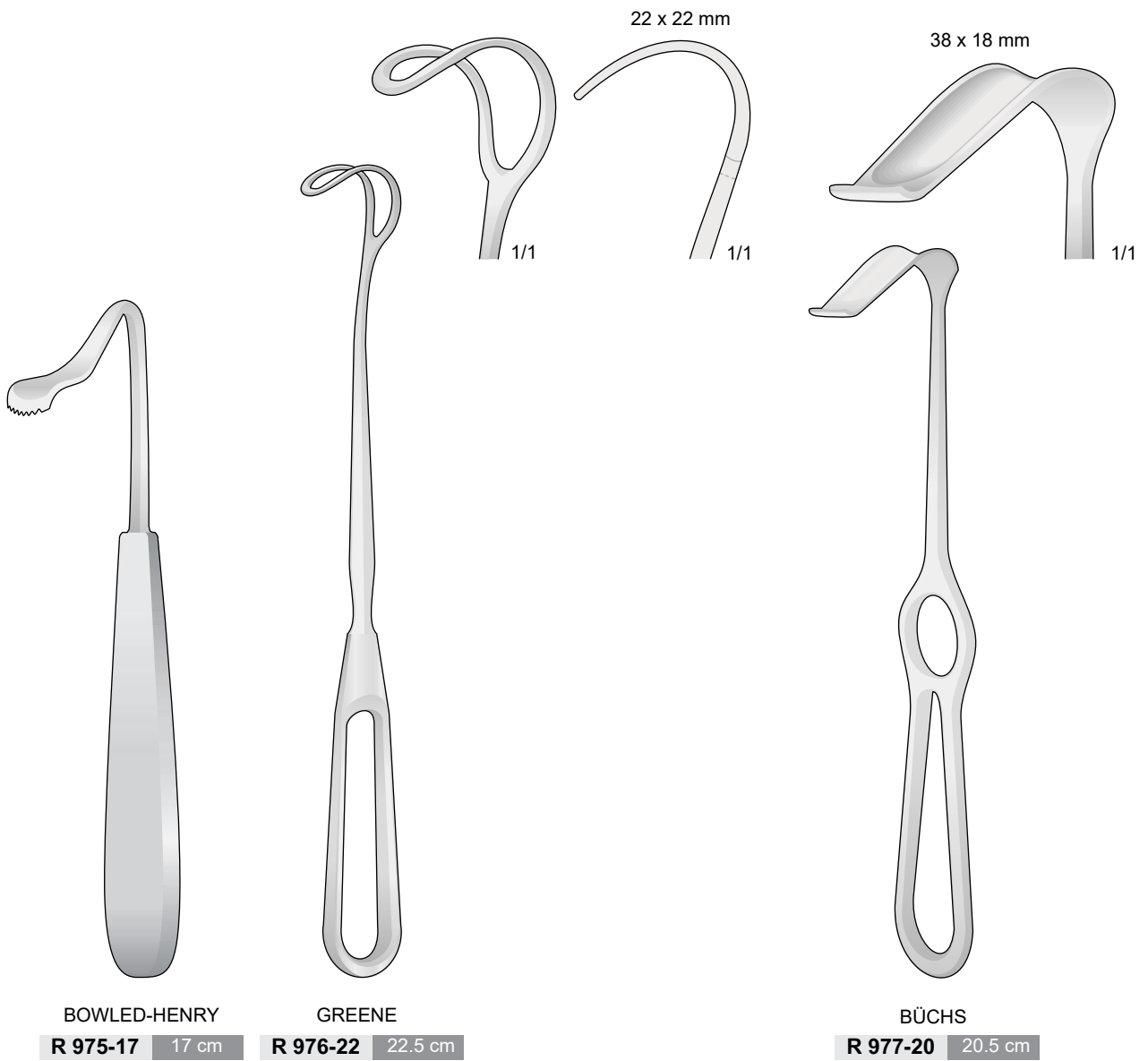

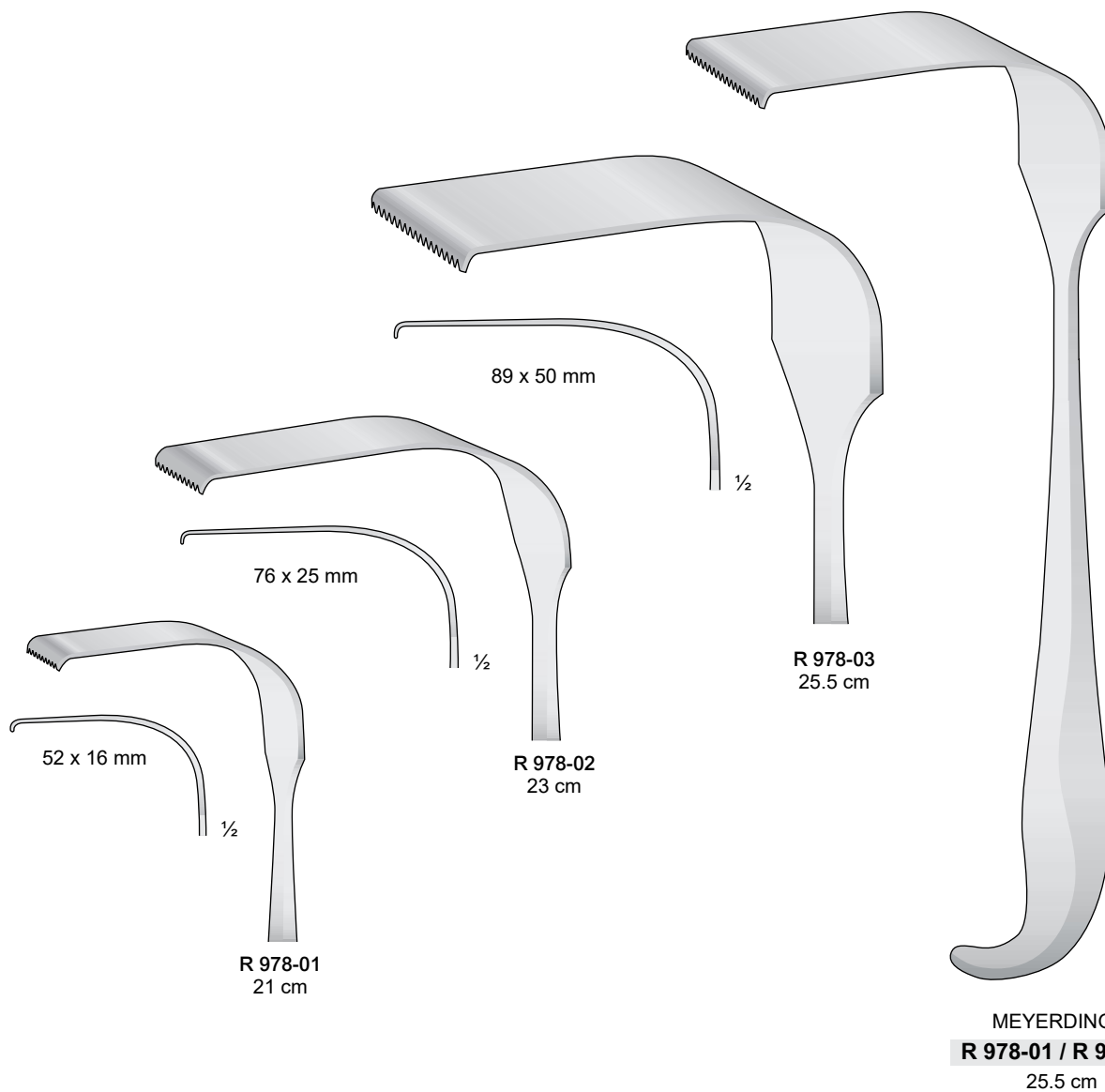

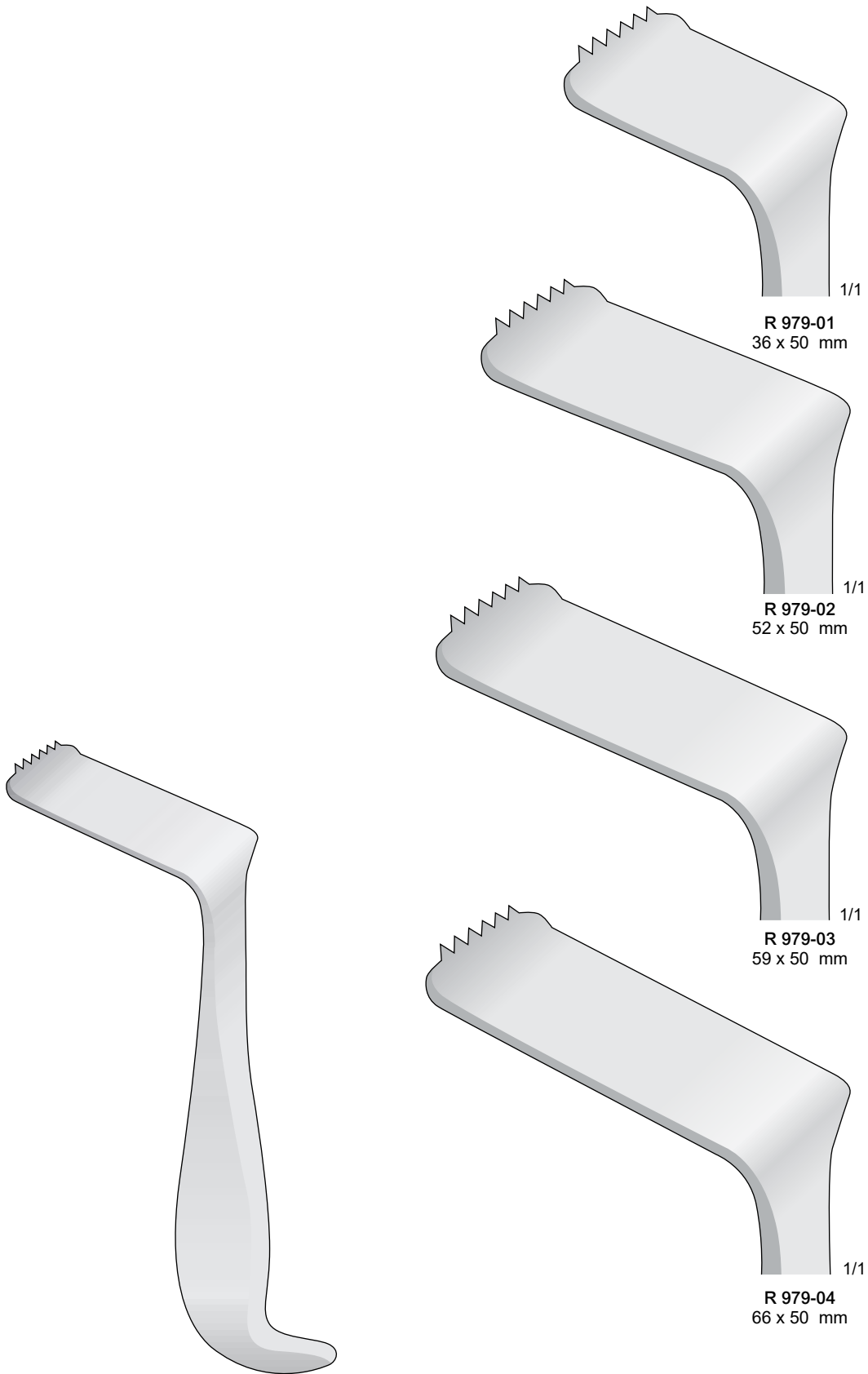

TESSIER
R 979-01 / R 979-04
18 cm

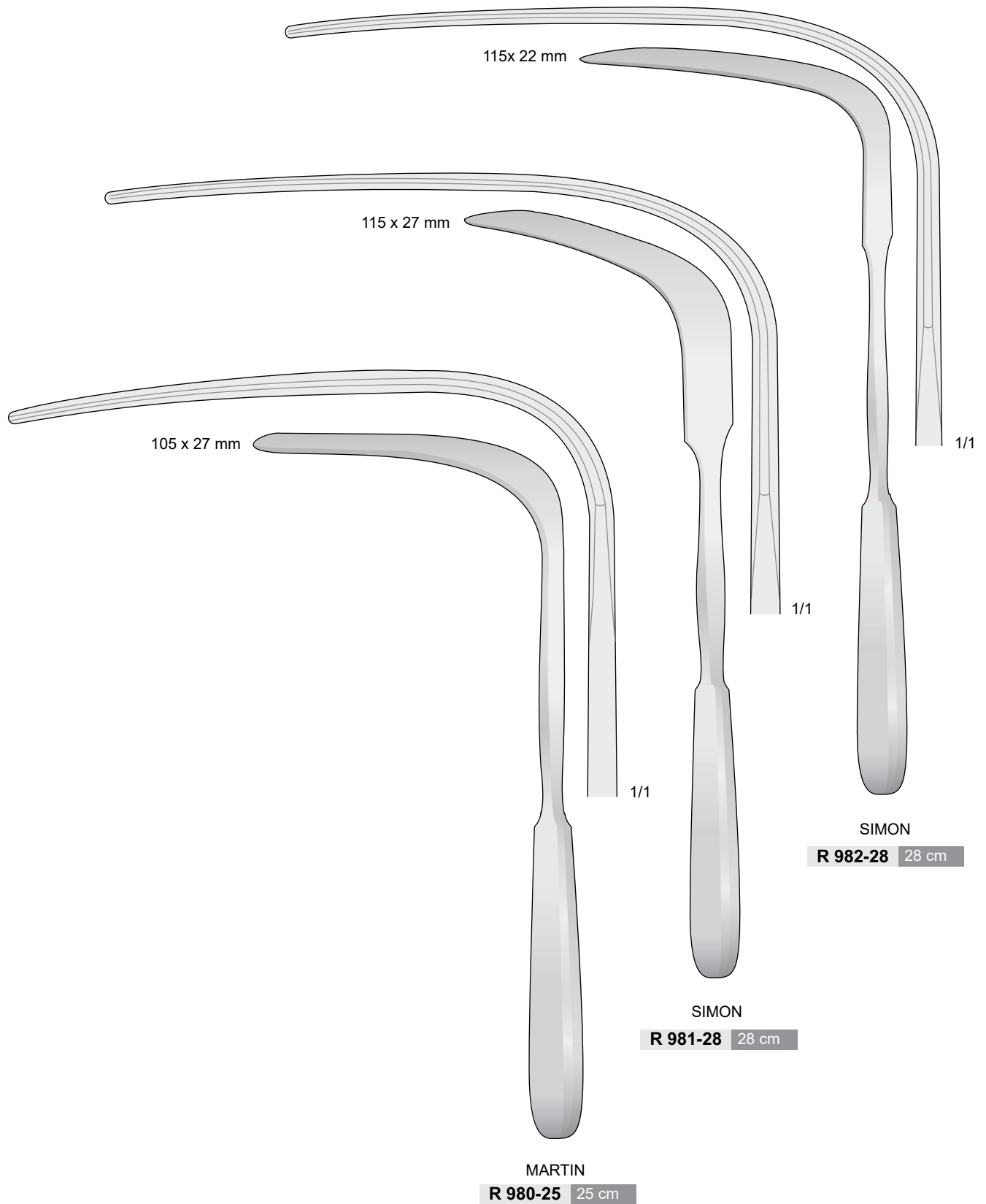

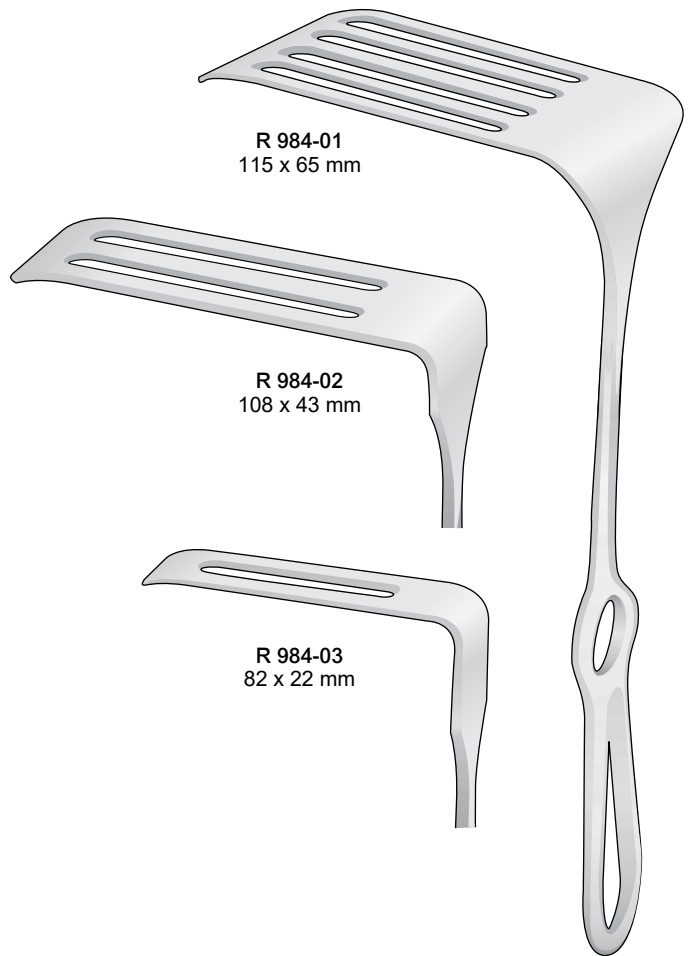
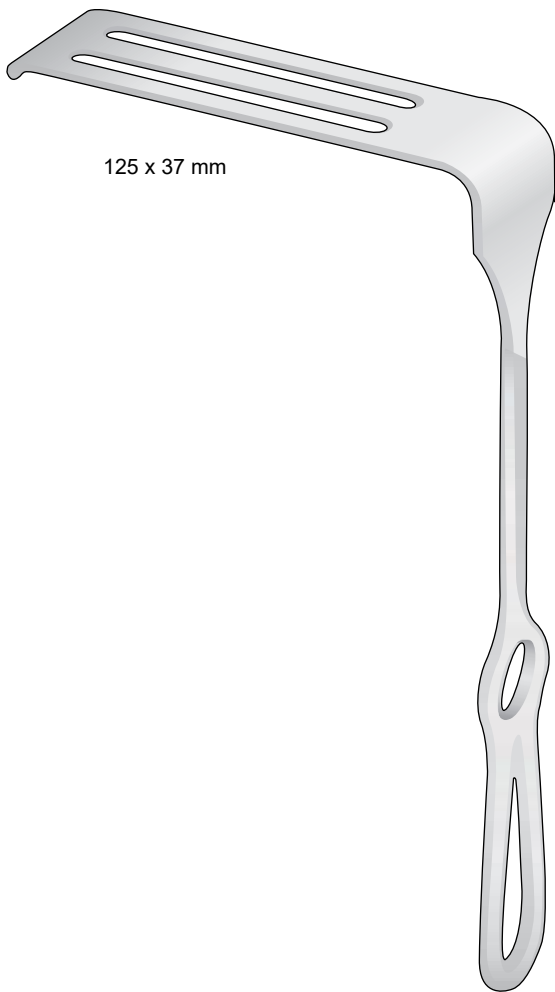
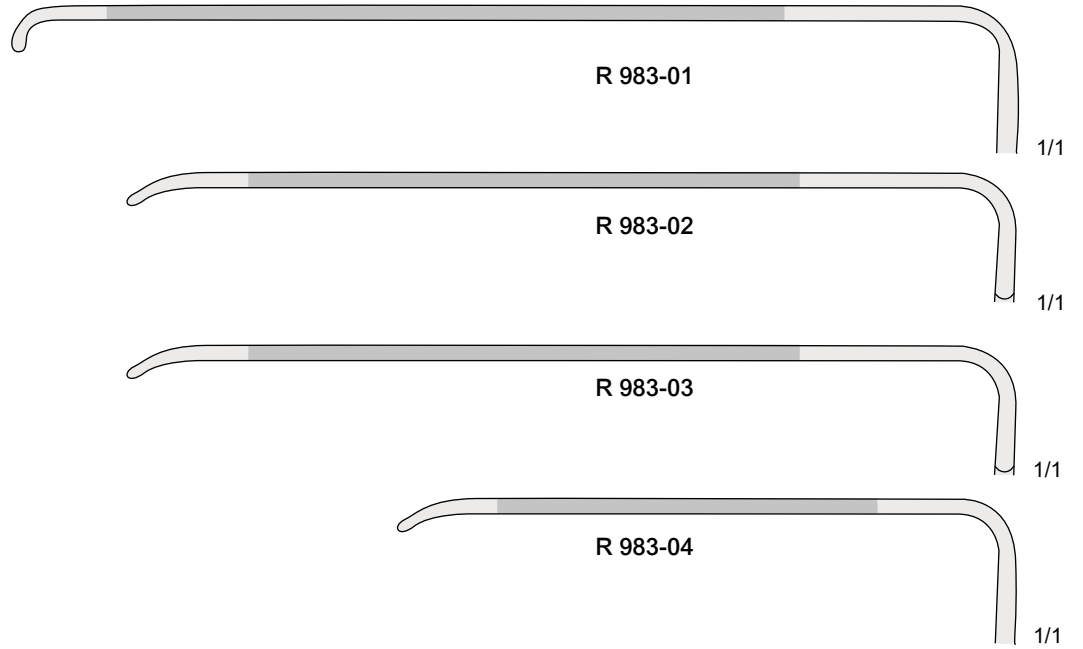

SAUERBRUCH
R 983-01 / R 983-04
26 cm

CORYLLOS
R 984-01 / R 984-03
25.5 cm

Retrattori per scapola
Scapula retractors
Scapula-Haken
Ecarteurs pour scapula
Separadores para scápula

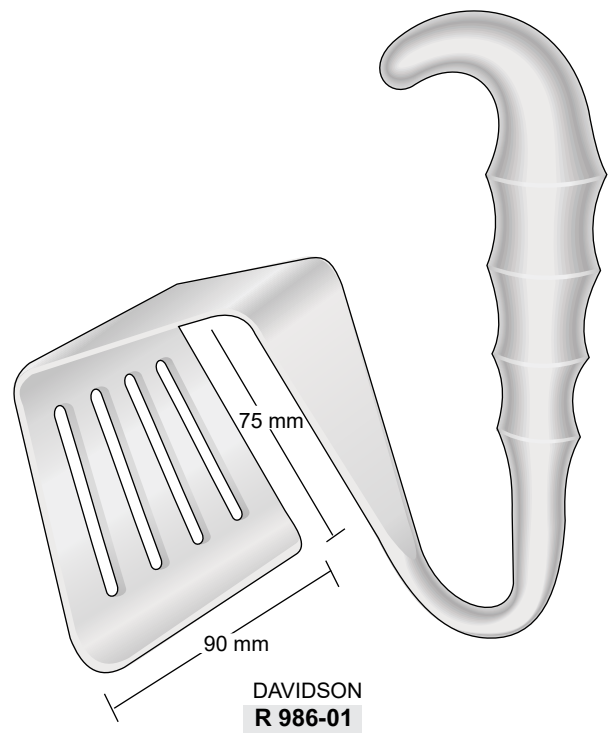
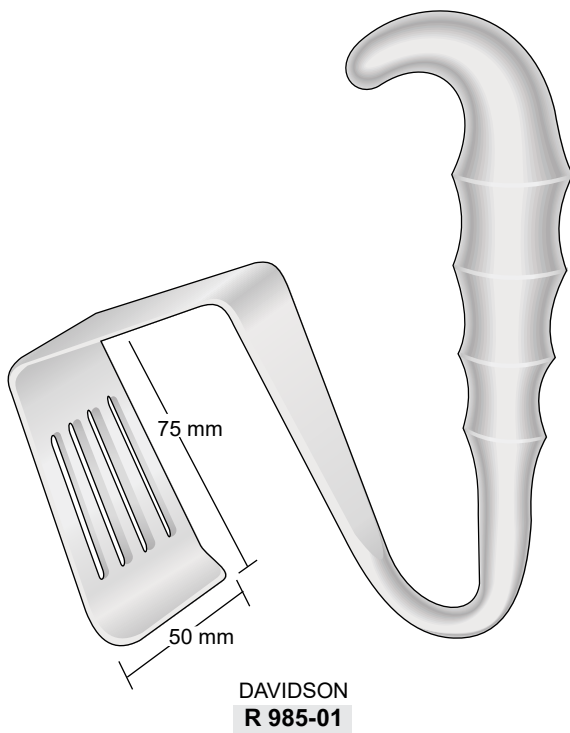

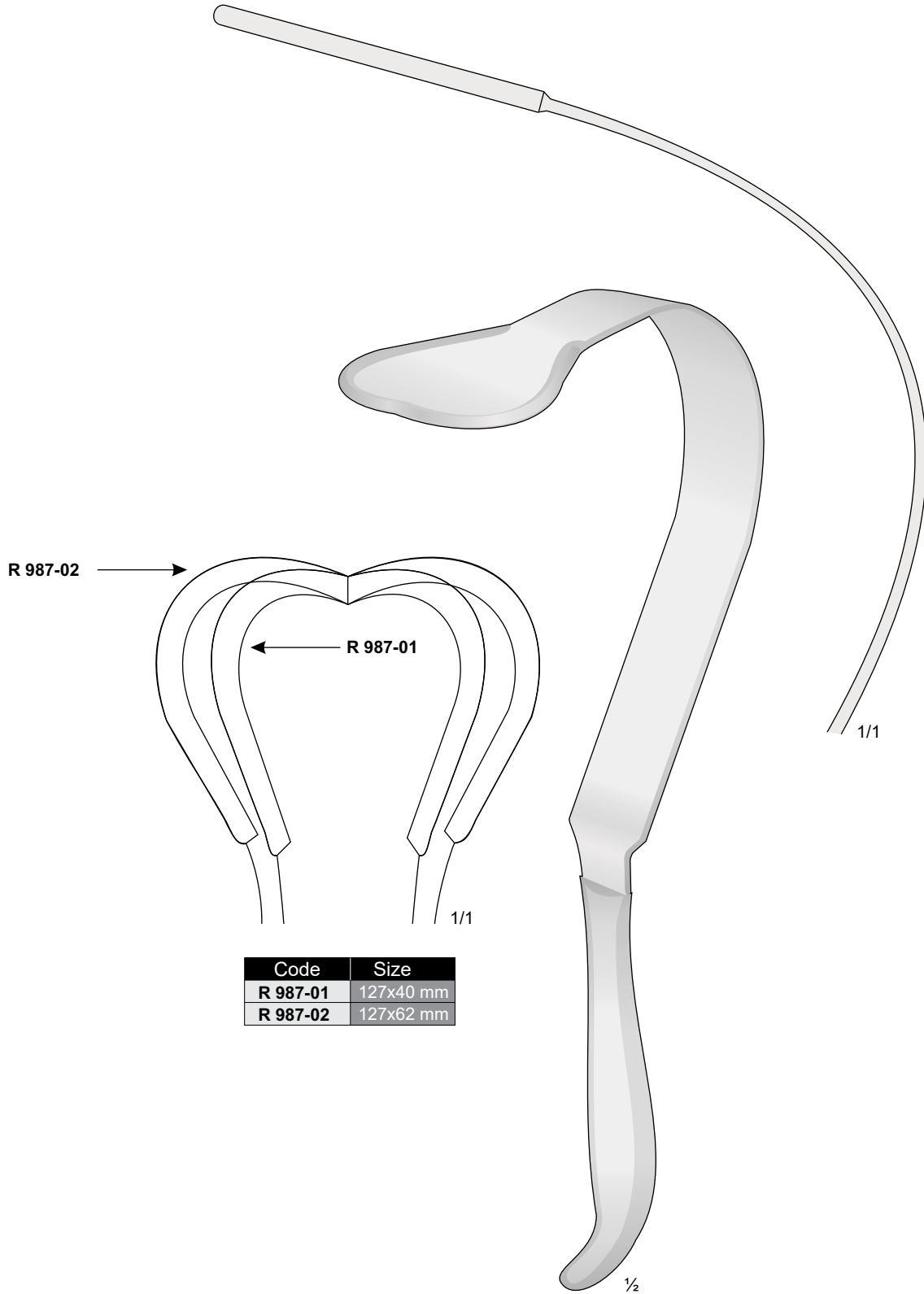

Code	Size
R 987-01	127x40 mm
R 987-02	127x62 mm

HARRINGTON
R 987-01 / R 987-02
32 cm

Spatole per polmone
Lung spatulas
Lungenspatel
Spatules pulmonaires
Espátulas pulmonares

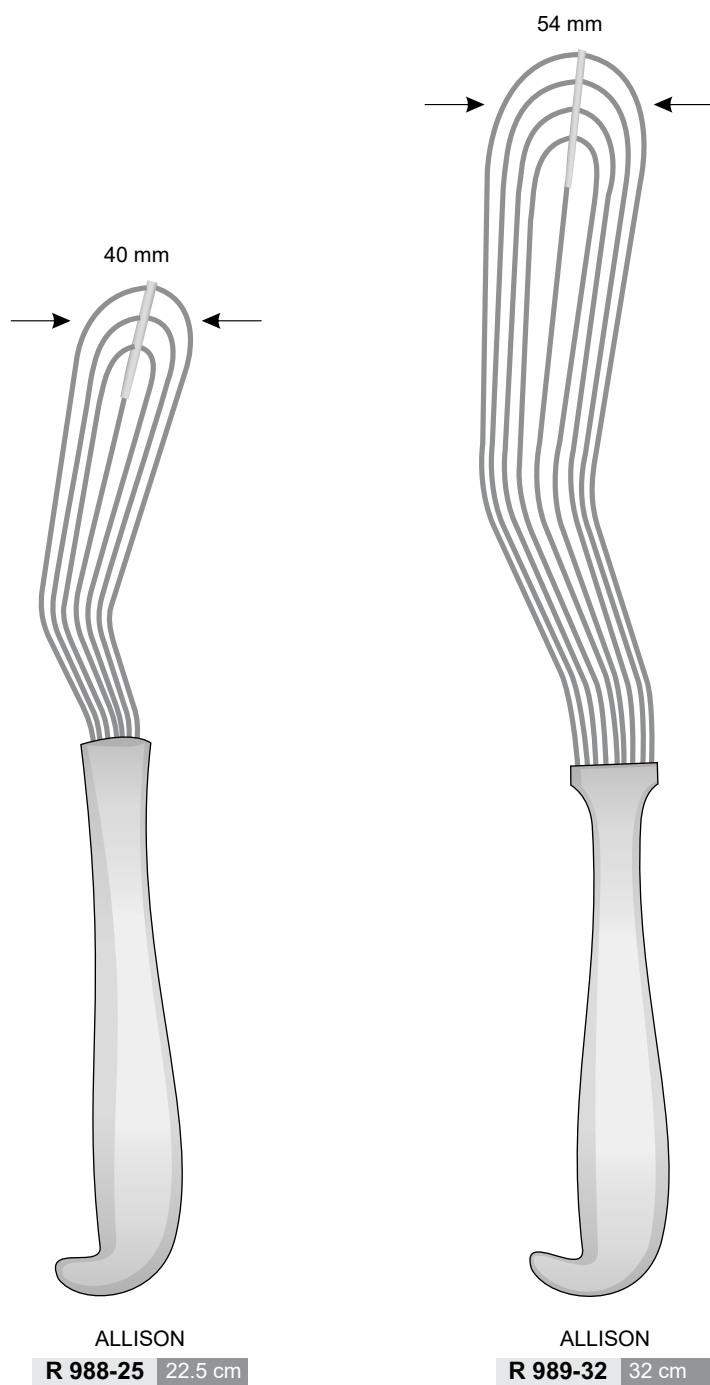

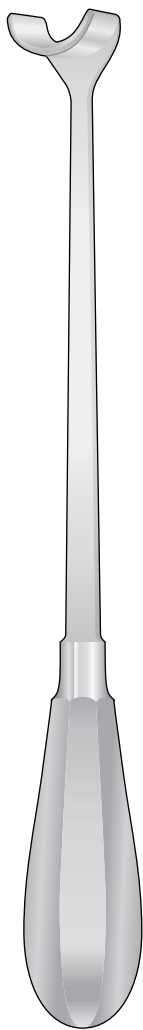

ROSS
R 990-01 / R 990-06
27 cm

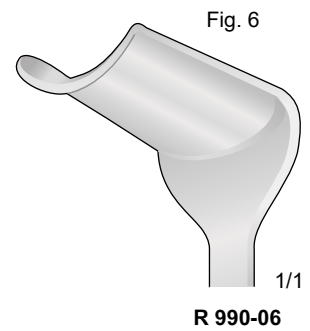
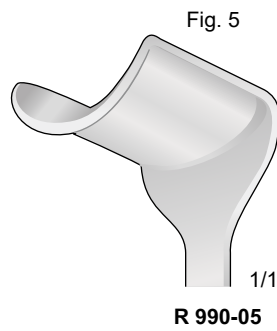
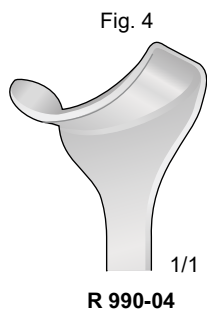

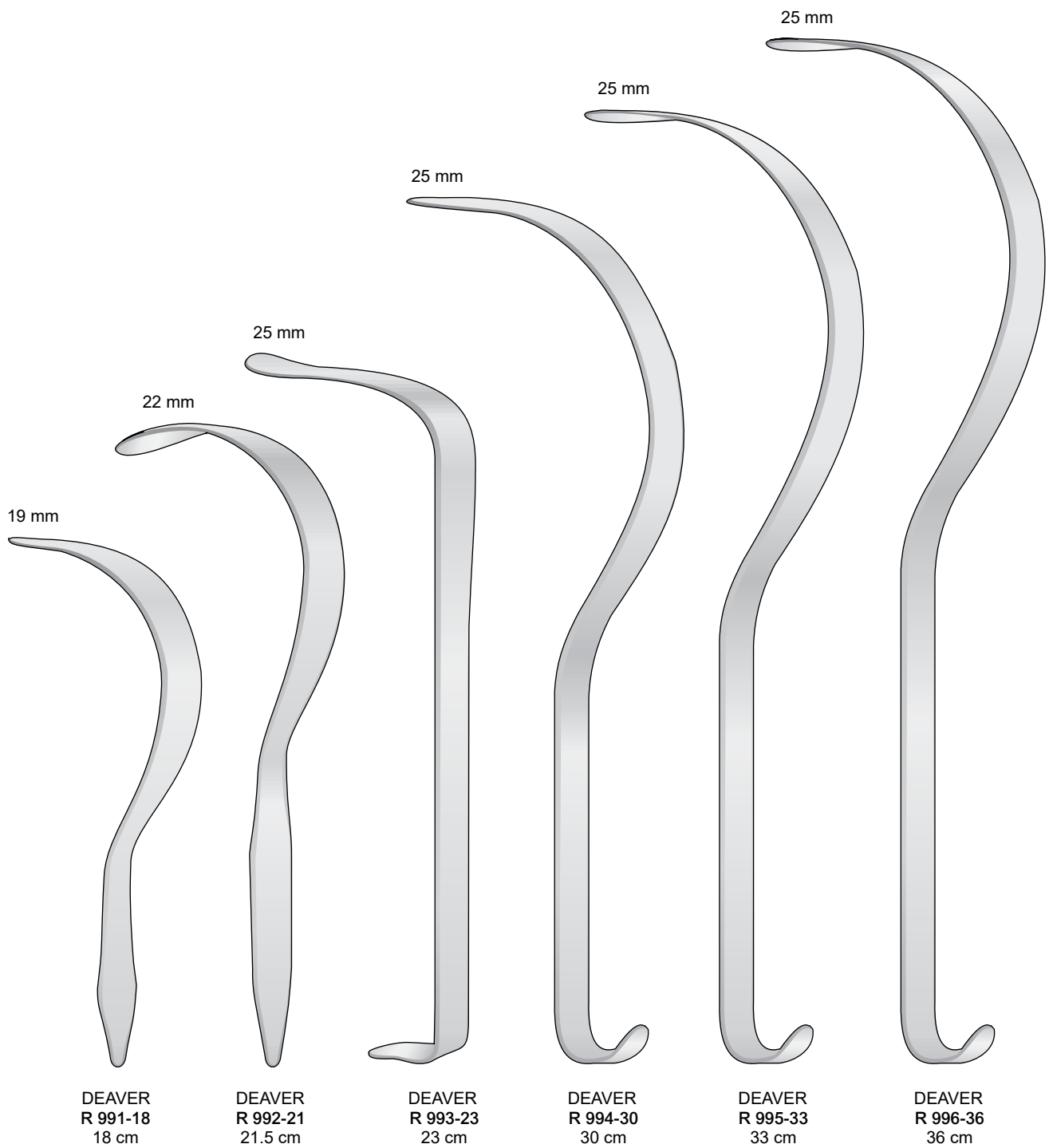

38 mm

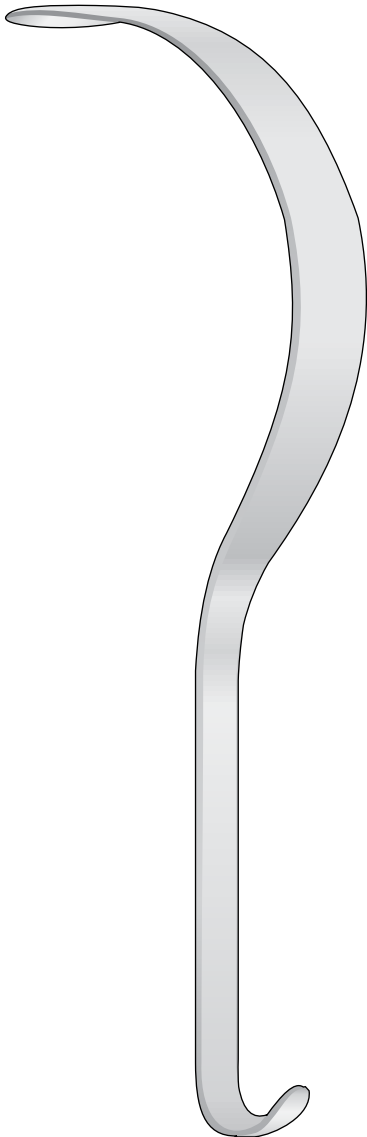

DEAVER
R 997-30 30 cm

50 mm



DEAVER
R 998-30 30 cm

75 mm

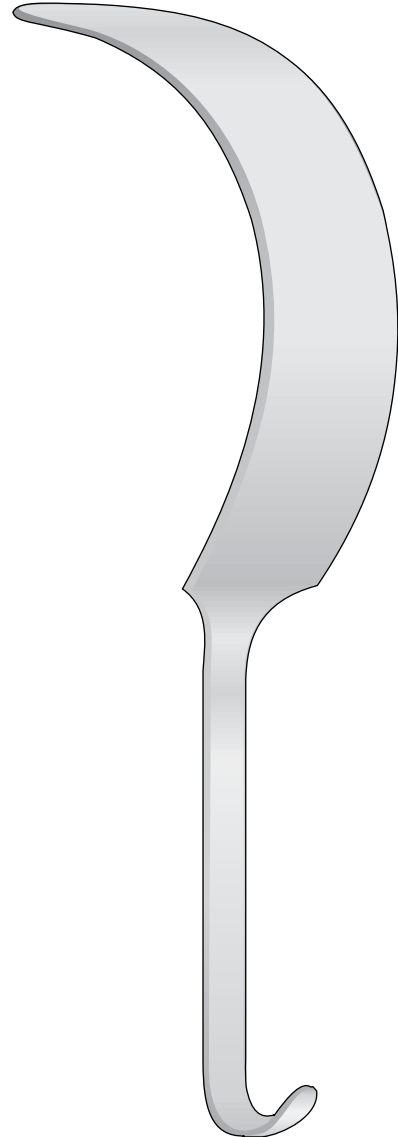

DEAVER
R 999-30 30 cm

Rigido - Fest - Rigid - Rigida

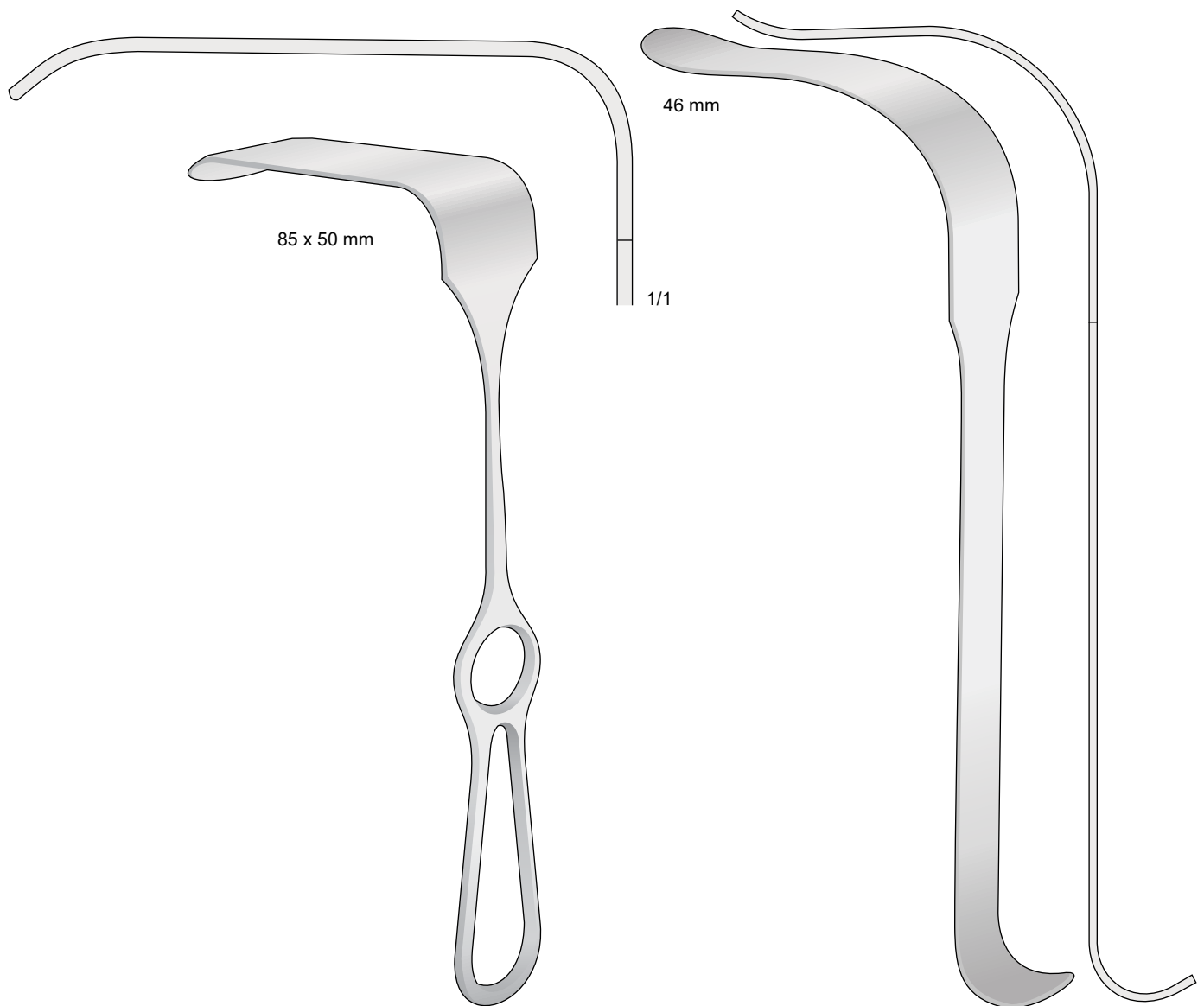

85 x 50 mm

46 mm

1/1

MIKULICZ

R 1000-26 26 cm

KOERTE

R 1001-30 30 cm

Destro
Right
Rechts
Droite
Derecha

45 mm
48 mm

Destro, leggermente dentallato
Right, slightly serrated
Rechts, mit zahnriefen
Droite, légèrement dentelé
Derecha, legermente dentados

45 mm
48 mm

Sinistro
Left
Links
Gauche
Izquierda

24 mm
48 mm

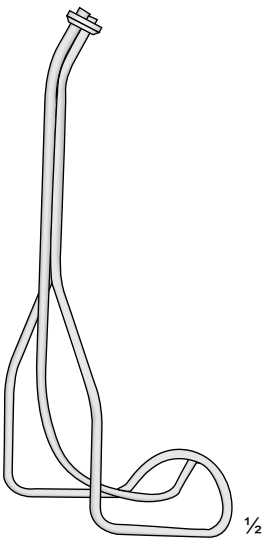

COOLEY
R 1002-21 21.5 cm

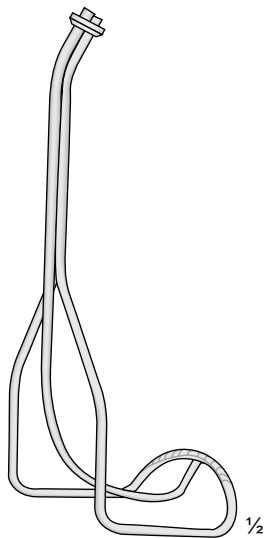

COOLEY
R 1003-21 21.5 cm

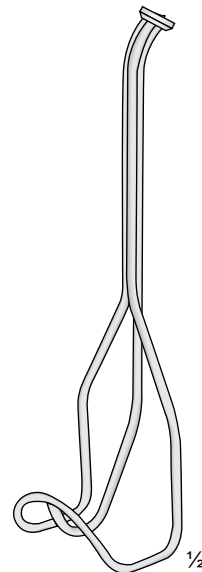

COOLEY
R 1004-23 23 cm

R 1008

Set completo con 3 spatole
Set complete with 3 spatulas
Kompletset mit 3 Spatel
Set complete avec 3 spatules
Set completos con 3 espátulas

R 1005-20 + R 1006-20 + R 1007-24

Spatole addominali e intestinali inox
Abdominal and intestinal spatulas
Bauch und Darmspatel
Ecarteurs abdominaux et intestinaux
Espátulas abdominales e intestinales

Malleabili - Malleable - Biegsam
Souples - Maleables

18

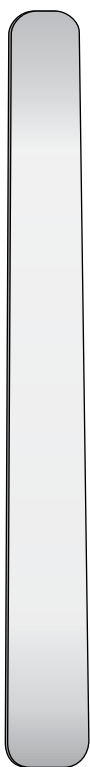

22

R 1005-20 20 cm

14



16

R 1006-20 20 cm

5



8

R 1007-24 24 cm

Spatole Inox malleabili antiriflesso nere
Spatulas malleable black anodized

18



22

R 1009-20 20 cm

14



16

R 1010-20 20 cm



Code	Size
R 1011-01	7+9 mm
R 1011-02	11+13 mm
R 1011-03	15+18 mm
R 1011-04	18+22 mm

CUSHING
R 1011-01 / R 1011-04
18 cm

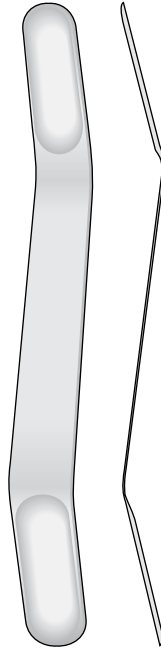

Code	Size
R 1012-01	7+9 mm
R 1012-02	11+13 mm
R 1012-03	15+18 mm
R 1012-04	18+22 mm

OLIVECRONA
R 1012-01 / R 1012-04
18 cm

Malleabile - Malleable
Biégam - Souple - Maleable



R 1013-3	3 cm
R 1013-4	4 cm
R 1013-5	5 cm

33 cm

Malleabile - Malleable
Biégam - Souple - Maleable



HABERER
R 1014-30 30 cm



REVERDIN
R 1015-28 28.5 cm

Malleabile - Malleable
Biégam - Souple - Maleable

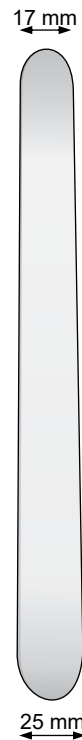

TUFFIER
R 1016-20 20 cm

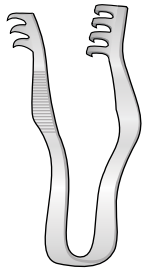

FINSEN

R 1017-01 / R 1017-04

Acuto
Sharp
Spitz
Pointu
Agudas

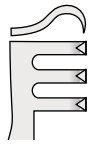

1/1

R 1017-01
05 cm

Smusso
Blunt
Stumpf
Mousse
Romos



1/1

R 1017-02
05 cm

Acuto
Sharp
Spitz
Pointu
Agudas



1/1

R 1017-03
05 cm

Smusso
Blunt
Stumpf
Mousse
Romos



1/1

R 1017-04
05 cm

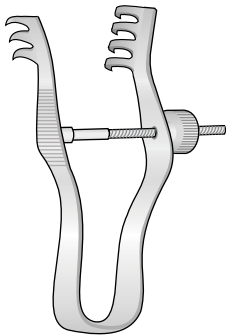

FINSEN

R 1017-01 / R 1017-02

07 cm

Acuto
Sharp
Spitz
Pointu
Agudas

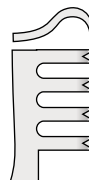

1/1

R 1018-01
07 cm

Smusso
Blunt
Stumpf
Mousse
Romos

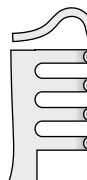

1/1

R 1018-02
07 cm

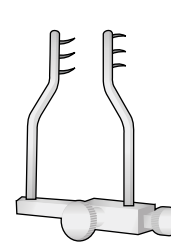

LOGAN

R 1018-04 04 cm

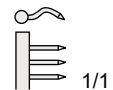

1/1

Acuto
Sharp
Spitz
Pointu
Agudas

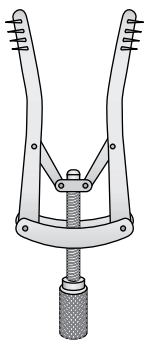

ALM

R 1019-07 07 cm

Smusso
Blunt
Stumpf
Mousse
Romos

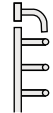

1/1

R 1019-07
70 mm

Acuto
Sharp
Spitz
Pointu
Agudas

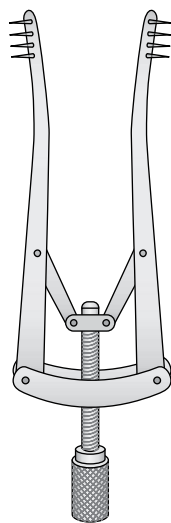

ALM

R 1020-10 10 cm

Smusso
Blunt
Stumpf
Mousse
Romos

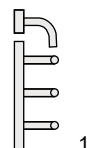

1/1

R 1020-10
100 mm



R 1021-10 10 cm

Smusso
Blunt
Stumpf
Mousse
Romos

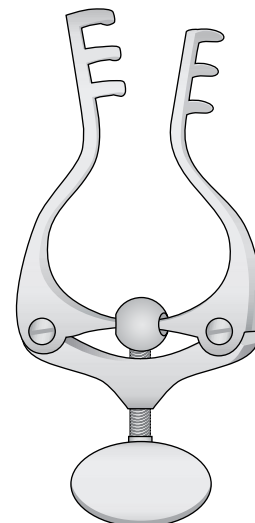
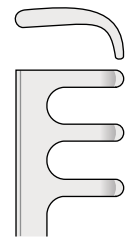

JANSEN

R 1022-10 10 cm

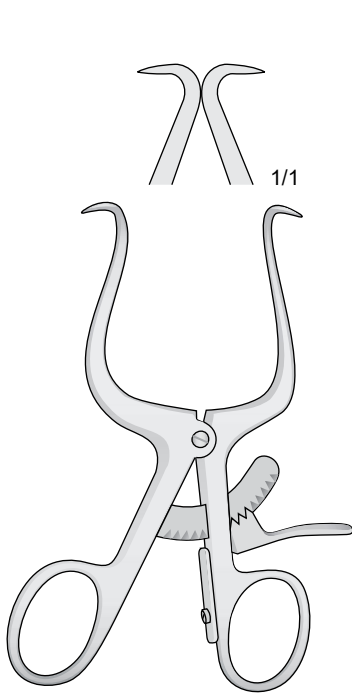

GELPI
R 1023-09 09 cm

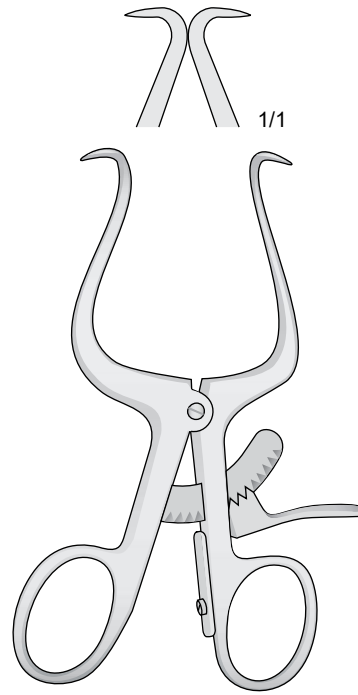

GELPI
R 1024-11 11 cm

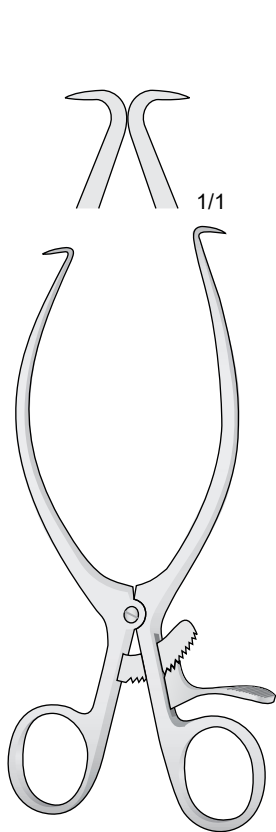

GELPI
R 1025-14 14 cm

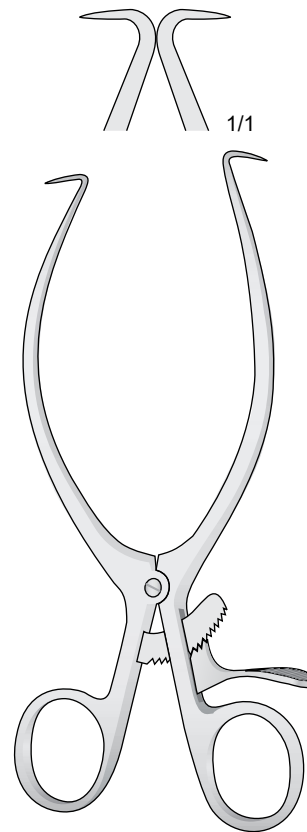

GELPI
R 1026-18 18 cm

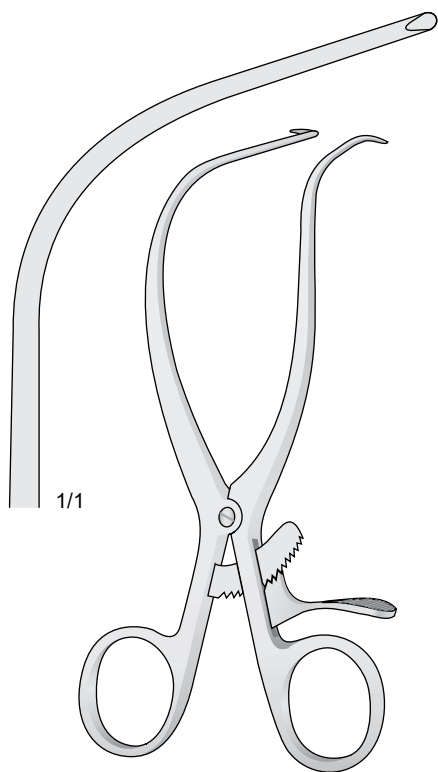

1/1

GELPI-SELETZ

R 1027-16 16.5 cm

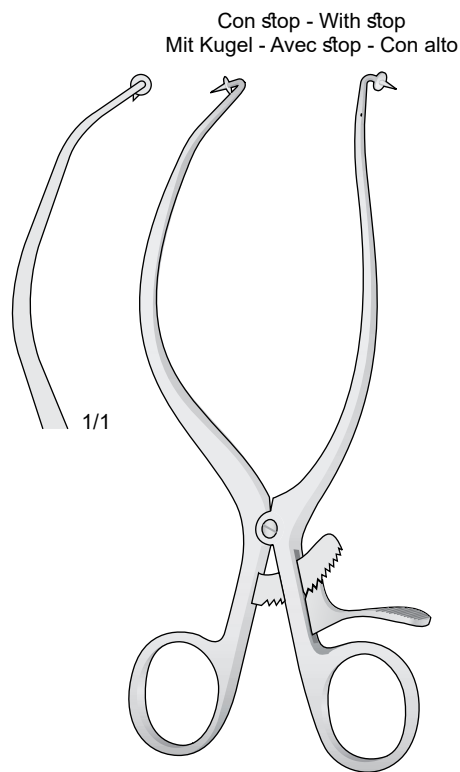

Con stop - With stop
 Mit Kugel - Avec stop - Con alto

1/1

GELPI-LOKTITE

R 1028-19 19 cm

Acuto
 Scharp
 Spitz
 Pointu
 Agudo

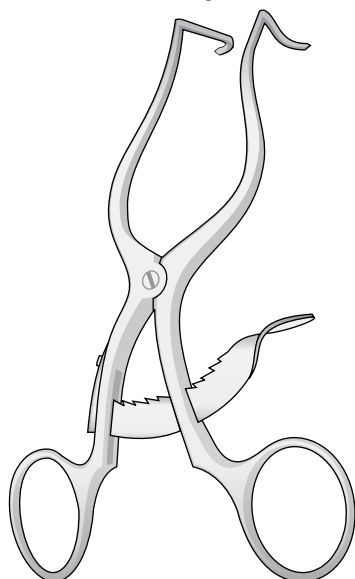

CLOWARD-CONTOUR

R 1029-14 14 cm

Smusso
 Blunt
 Stumpf
 Mousse
 Romas

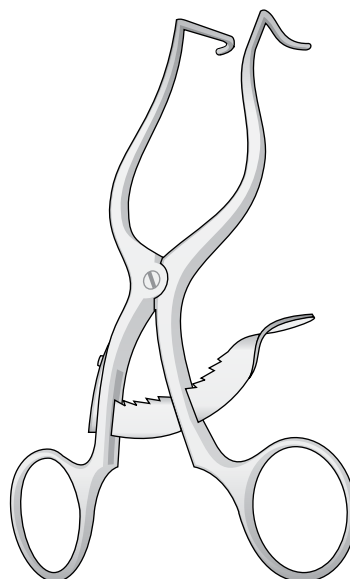

CLOWARD-CONTOUR

R 1030-14 14 cm

Acuto
Sharp
Spitz
Pointu
Agudo

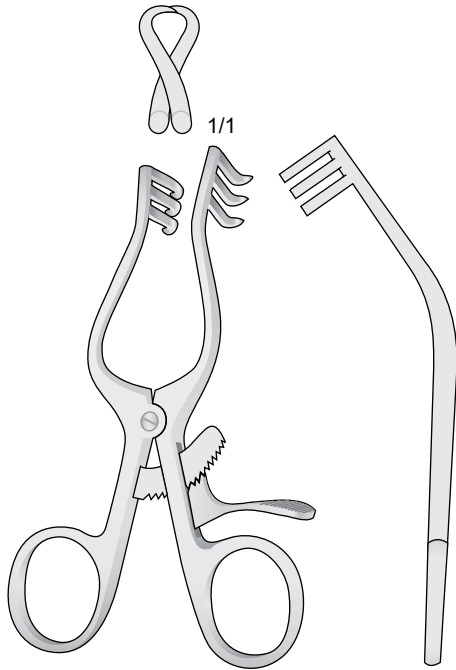

WULLSTEIN
R 1031-10 10.5 cm

Smusso
Blunt
Stumpf
Mousse
Romo

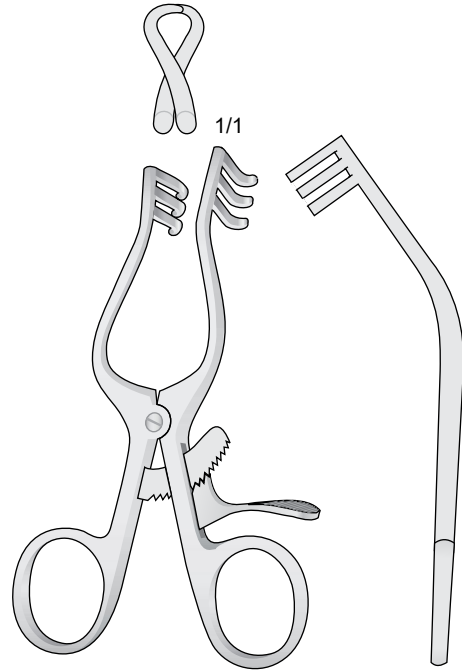

WULLSTEIN
R 1032-10 10.5 cm

Acuto
Sharp
Spitz
Pointu
Agudo

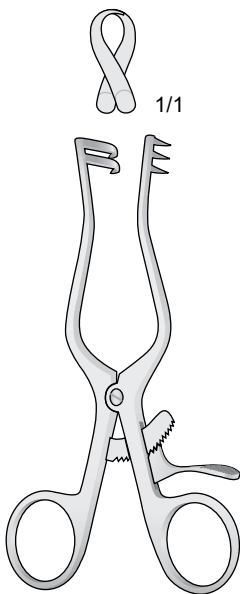

WEITLANER
R 1033-11 11 cm

Smusso
Blunt
Stumpf
Mousse
Romo

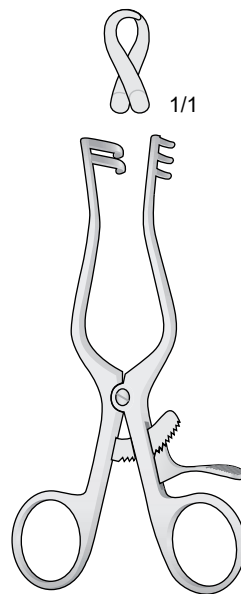

WEITLANER
R 1034-11 11 cm

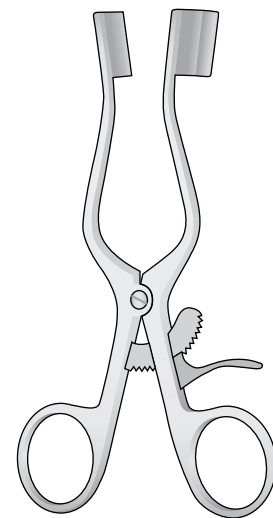
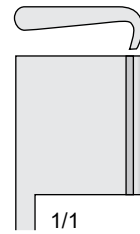

BABY-WEITLANER
R 1035-14 14 cm

Semi acuto - Semi Sharp - Halbscharf
 Semi Pointu - Semi Agudas

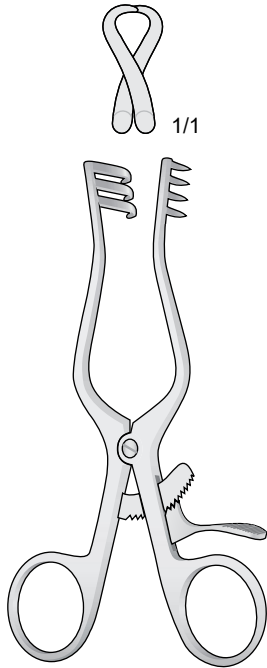

WEITLANER
R 1036-13 13.5 cm

Acuto - Sharp - Spitz
 Pointu - Agudas

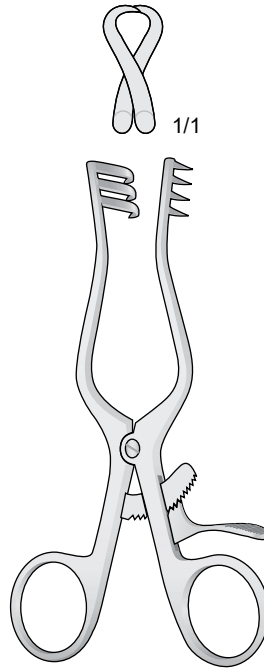

WEITLANER
R 1037-13 13.5 cm

Smusso - Blunt - Stumpf
 Mousse - Romas

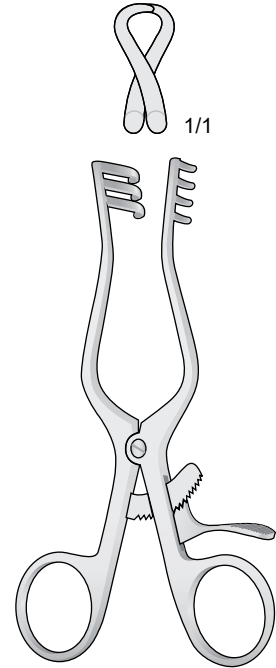

WEITLANER
R 1038-13 13.5 cm

Acuto - Sharp - Spitz
 Pointu - Agudas

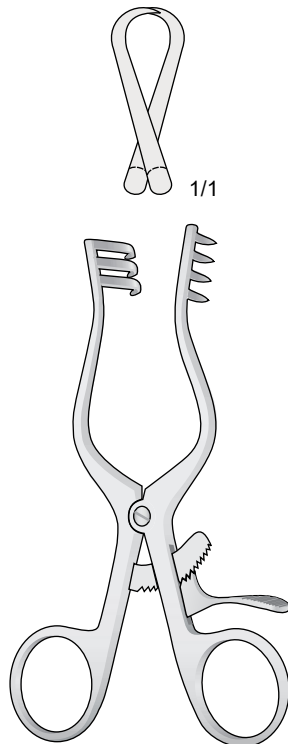

WEITLANER
R 1039-13 13.5 cm

Smusso - Blunt - Stumpf
 Mousse - Romas

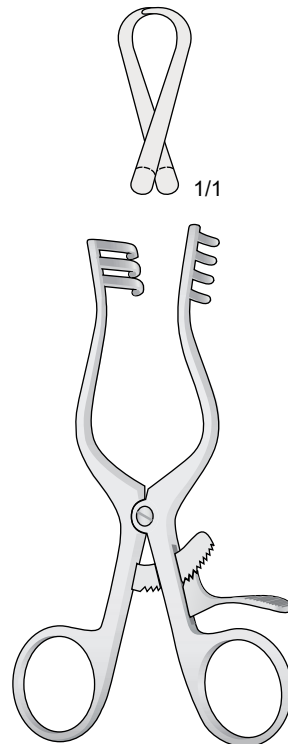

WEITLANER
R 1040-13 13.5 cm

Semi acuto - Sharp - Halbscharf
Semi Pointu - Agudas

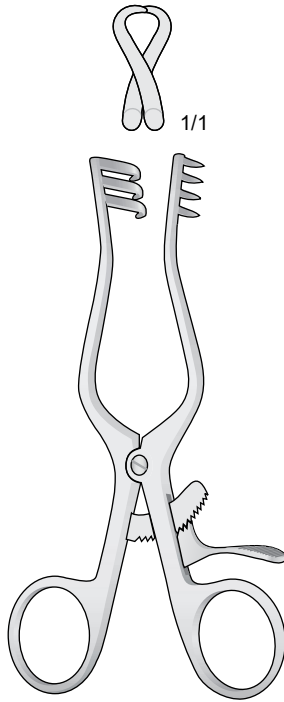

WEITLANER
R 1041-16 16.5 cm

Acuto - Sharp - Spitz
Pointu - Agudas

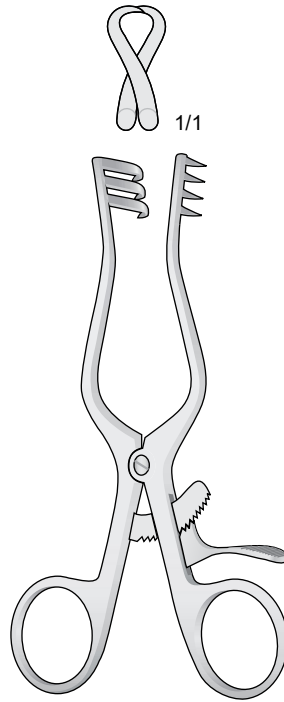

WEITLANER
R 1042-16 16.5 cm

Smusso - Blunt - Stumpf
Mousse - Romas

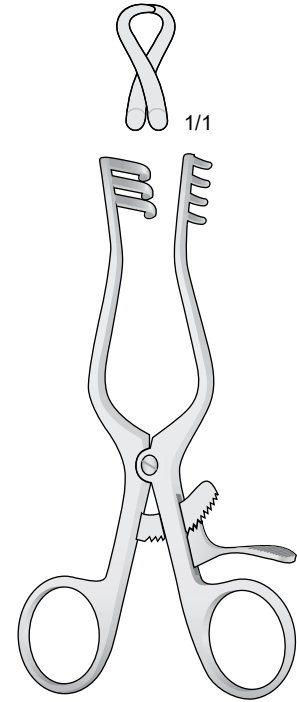

WEITLANER
R 1043-16 16.5 cm

Acuto - Sharp - Spitz
Pointu - Agudas

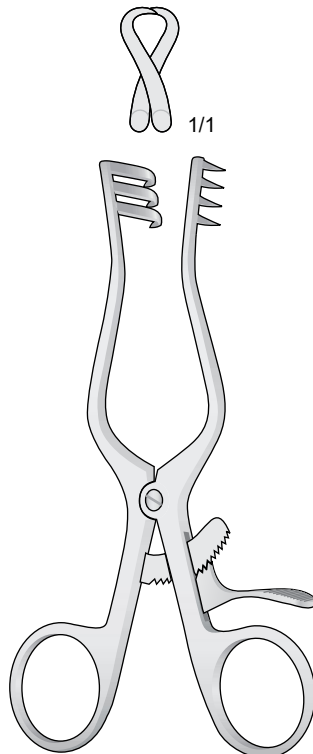

WEITLANER
R 1044-20 20 cm

Smusso - Blunt - Stumpf
Mousse - Romas

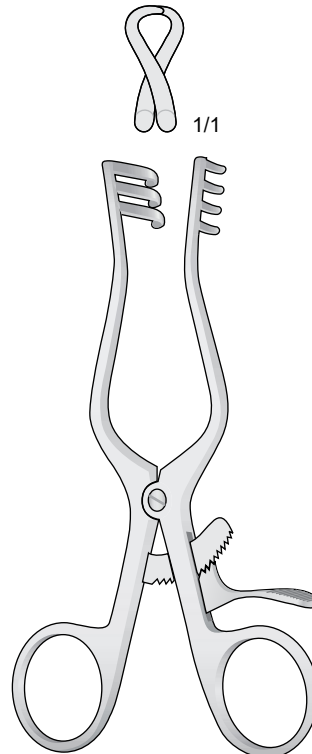

WEITLANER
R 1045-20 20 cm

Acuto - Sharp - Spitz
Pointu - Agudas

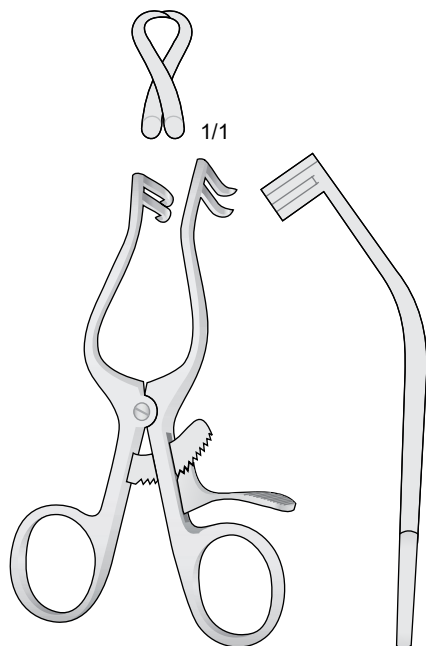

PLESTER
R 1046-11 11 cm

Smusso - Blunt - Stumpf
Mousse - Romas

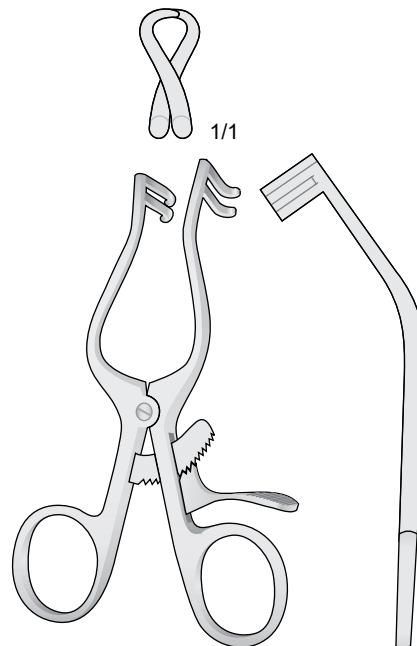

PLESTER
R 1047-11 11 cm

Acuto - Sharp - Spitz
Pointu - Agudas

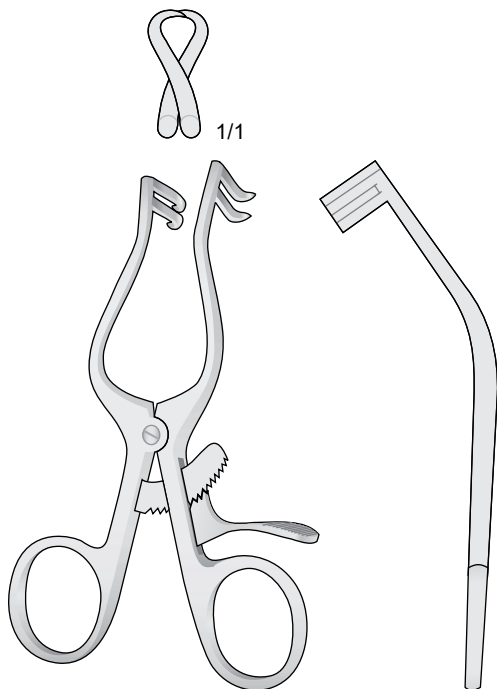

PLESTER
R 1048-13 13.5 cm

Smusso - Blunt - Stumpf
Mousse - Romas

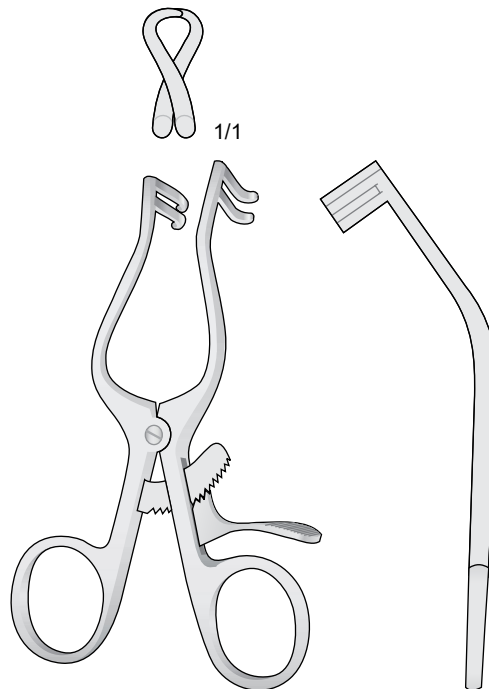

PLESTER
R 1049-13 13.5 cm

Smusso - Blunt - Stumpf - Mousse - Rome

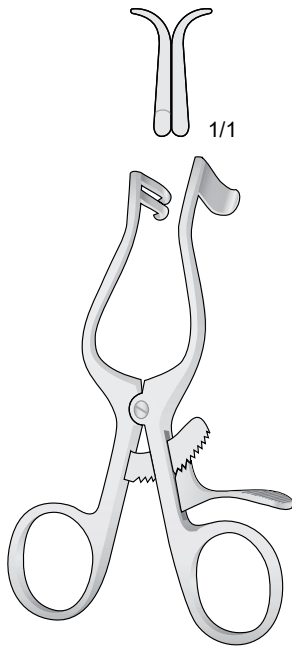

PLESTER
R 1050-11 11 cm

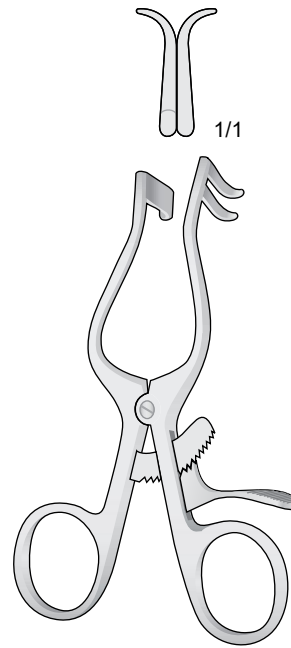

PLESTER
R 1051-11 11 cm

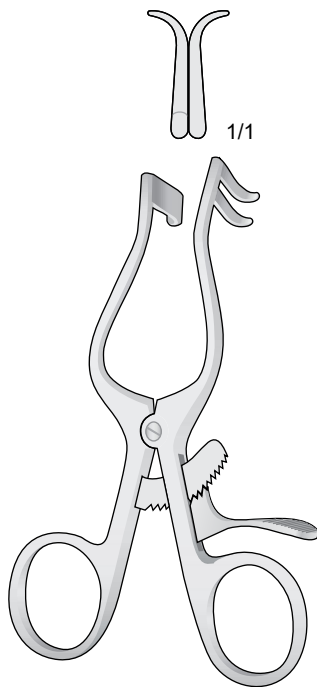

PLESTER
R 1052-13 13.5 cm

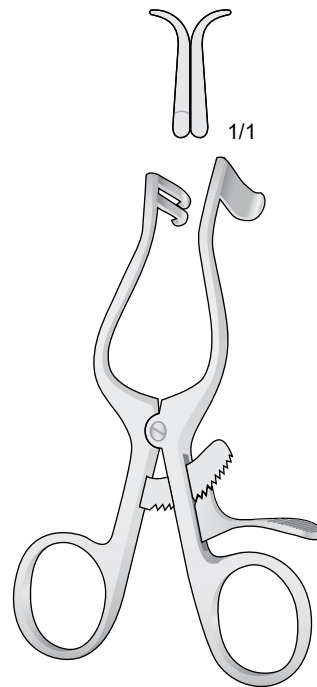

PLESTER
R 1053-13 13.5 cm

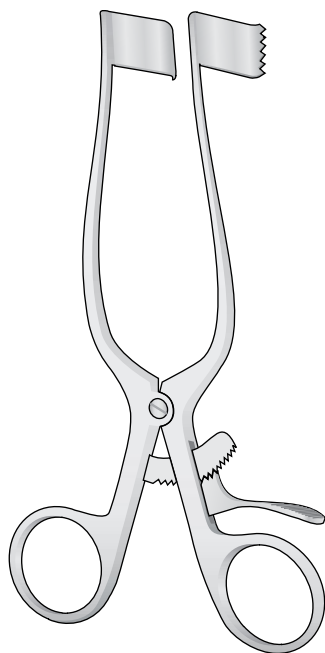

MEYERDING 18 cm

R 1054-01	32 x 25 mm
R 1054-02	60 x 25 mm
R 1054-04	54 x 25 mm
R 1054-05	60 x 20 mm

Acuto - Sharp - Spitz
 Pointu - Agudo

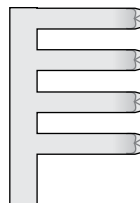

R 1056-01
 20 cm

Smusso - Blunt - Stumpf
 Mousse - Rome

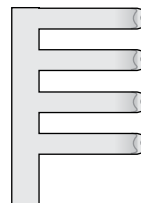

R 1056-01
 20 cm

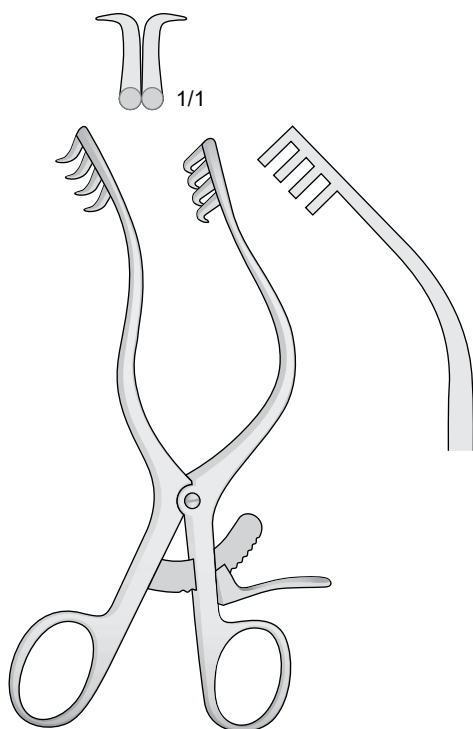

MOLLISON
R 1055-16 16 cm

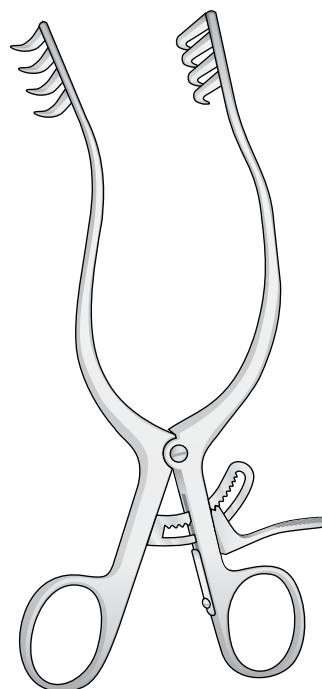

ANDERSON-ADSON
R 1056-01 / R 1056-02

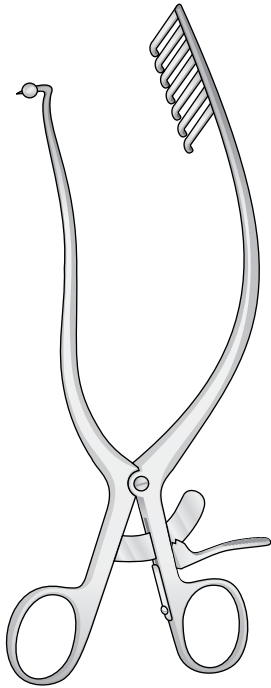

WALTON
R 1057-18 18 cm

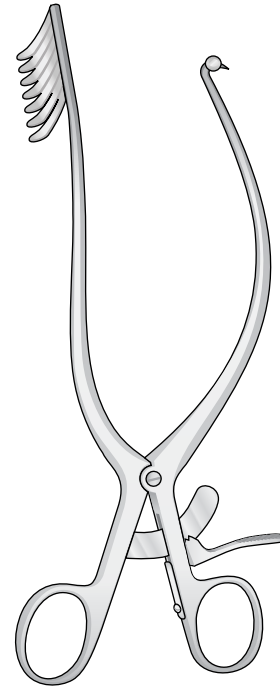

WALTON
R 1058-18 18 cm

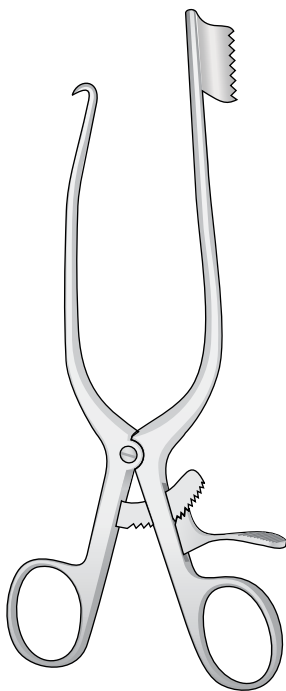

MARKHAM-MEYERDING
R 1059-18 18 cm

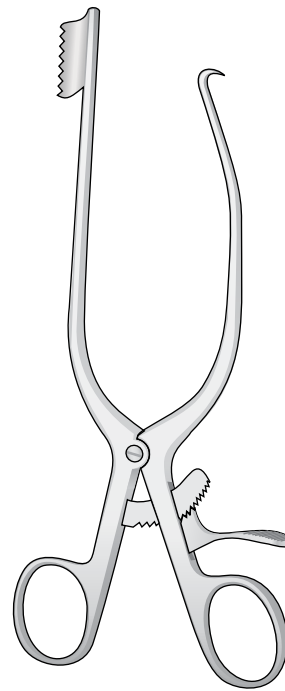

MARKHAM-MEYERDING
R 1060-18 18 cm

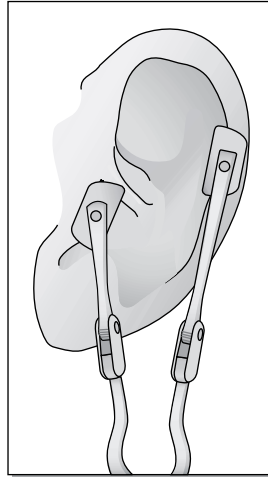

Lame, sinistro
Blades, left
Klingen, Link
Lames, gauche
Hojas, izquierda
13 x 20 mm

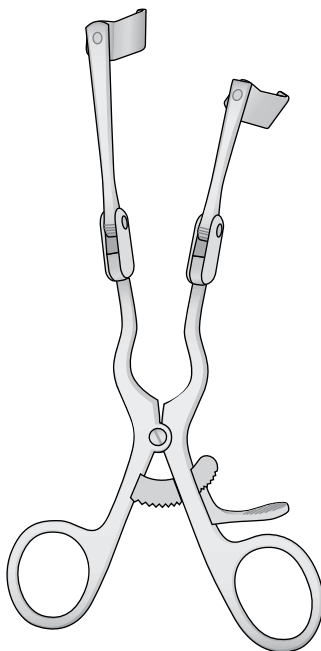

DOLWICK-REICH
R 1061-17 17 cm

Lame, destro
Blades, right
Klingen, Rechts
Lames, droite
Hojas, derecha
13 x 20 mm

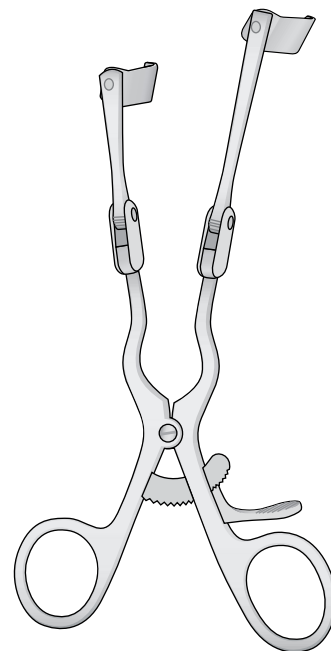

DOLWICK-REICH
R 1062-17 17 cm

Acuto - Sharp - Spitz
Pointu - Agudo

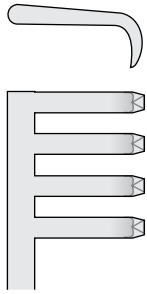

R 1063-01
20 cm

Smusso - Blunt - Stumpf
Mousse - Rome

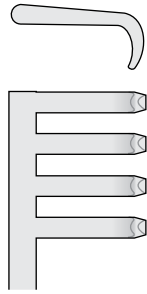

R 1063-02
20 cm

4 x 4 Denti
4 x 4 Teeth
4 x 4 Zähne
4 x 4 Dents
4 x 4 Dientes

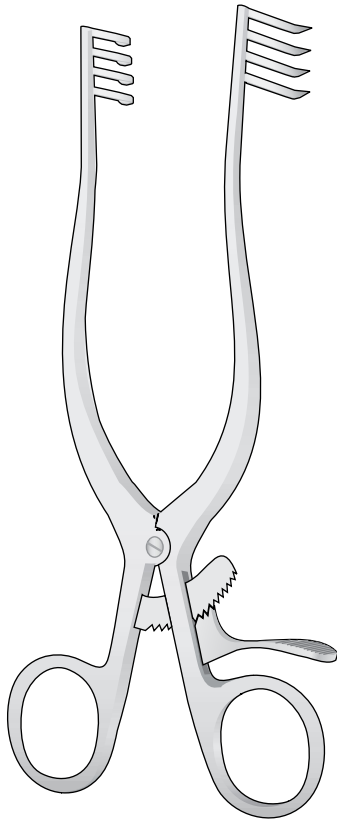

ADSON
R 1063-01 / R 1063-02

Acuto - Sharp - Spitz
Pointu - Agudo

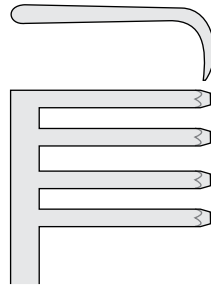

R 1064-01
25 cm

Smusso - Blunt - Stumpf
Mousse - Rome

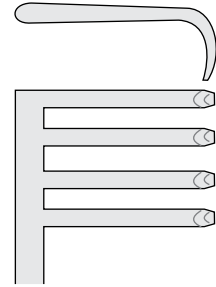

R 1064-02
25 cm

4 x 4 Denti
4 x 4 Teeth
4 x 4 Zähne
4 x 4 Dents
4 x 4 Dientes

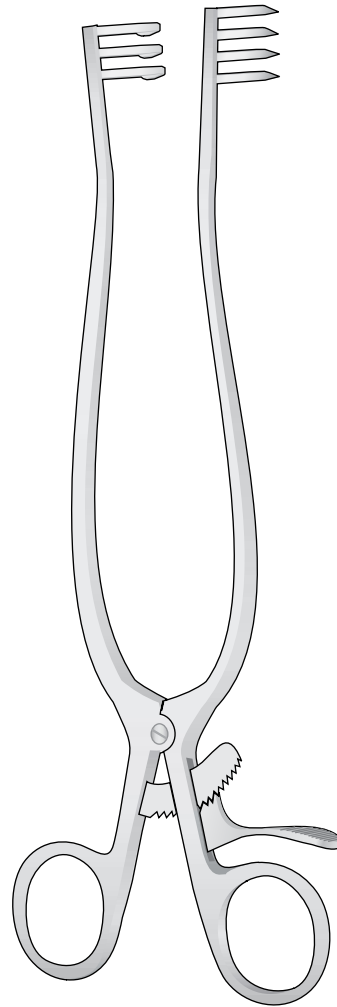

WEITLANER
R 1064-01 / R 1064-02

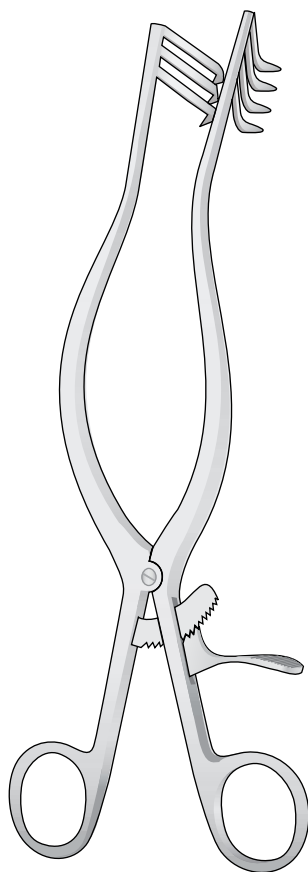

ADSON
R 1065-01 / R 1065-04

3 x 4 Denti
 3 x 4 Teeth
 3 x 4 Zähne
 3 x 4 Dents
 3 x 4 Dientes

Acuto
 Sharp
 Spitz
 Pointù
 Agudas

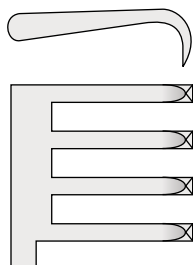

R 1065-01
 26.5 cm

Smusso
 Blunt
 Stumpf
 Mousse
 Romas

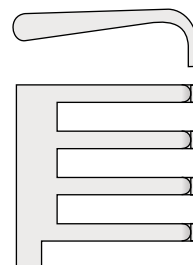

R 1065-02
 26.5 cm

6 x 6 Denti
 6 x 6 Teeth
 6 x 6 Zähne
 6 x 6 Dents
 6 x 6 Dientes

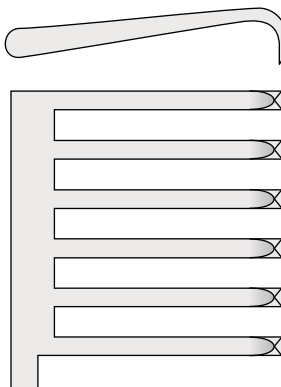

R 1065-03
 26.5 cm

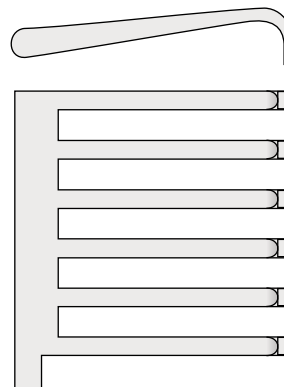

R 1065-04
 26.5 cm

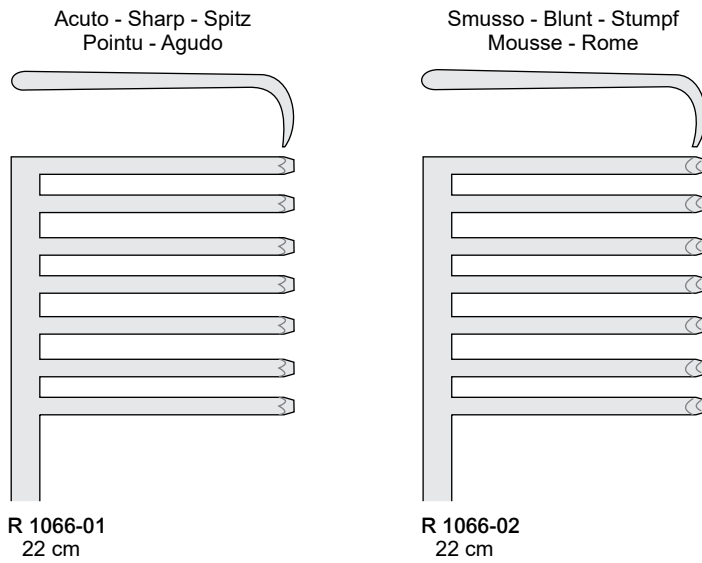

7 x 7 Denti
7 x 7 Teeth
7 x 7 Zähne
7 x 7 Dents
7 x 7 Dientes

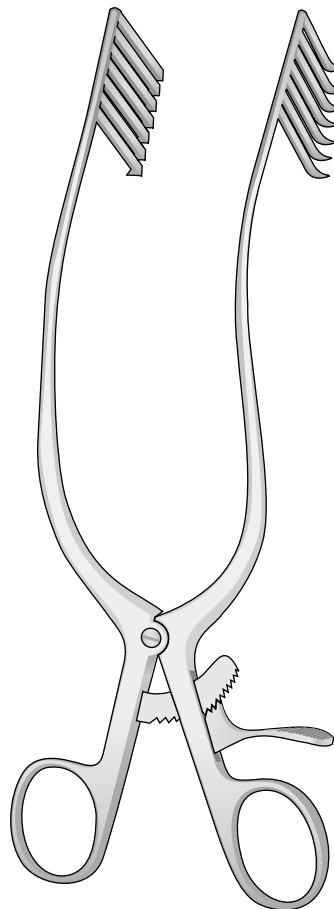

MISKIMON
R 1066-01 / R 1066-02

3 x 4 Denti
 3 x 4 Teeth
 3 x 4 Zähne
 3 x 4 Dents
 3 x 4 Dientes

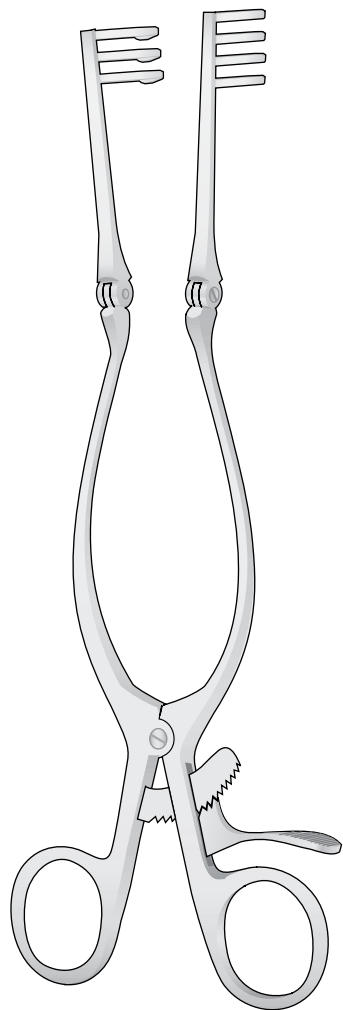

ADSON

R 1067-01 / R 1067-08

Acuto
 Scharp
 Spitz
 Pointu
 Agudo

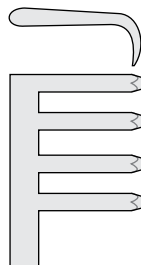

R 1067-01
 14 cm

Smusso
 Blunt
 Stumpf
 Mousse
 Romas

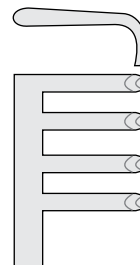

R 1067-02
 14 cm

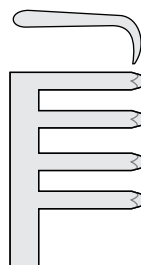

R 1067-03
 16.5 cm

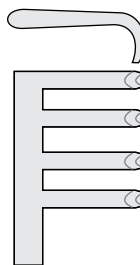

R 1067-04
 16.5 cm

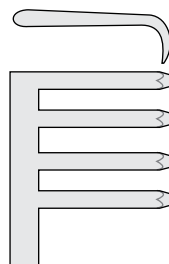

R 1067-05
 20 cm

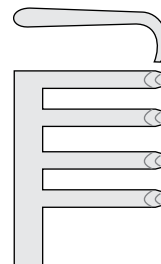

R 1067-06
 20 cm

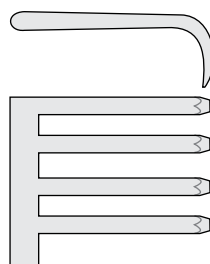

R 1067-07
 25 cm

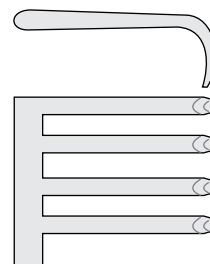

R 1067-08
 25 cm

Acuto - Sharp
Spitz - Pointu
Agudas

4 x 4 Denti
4 x 4 Teeth
4 x 4 Zähne
4 x 4 Dents
4 x 4 Dientes

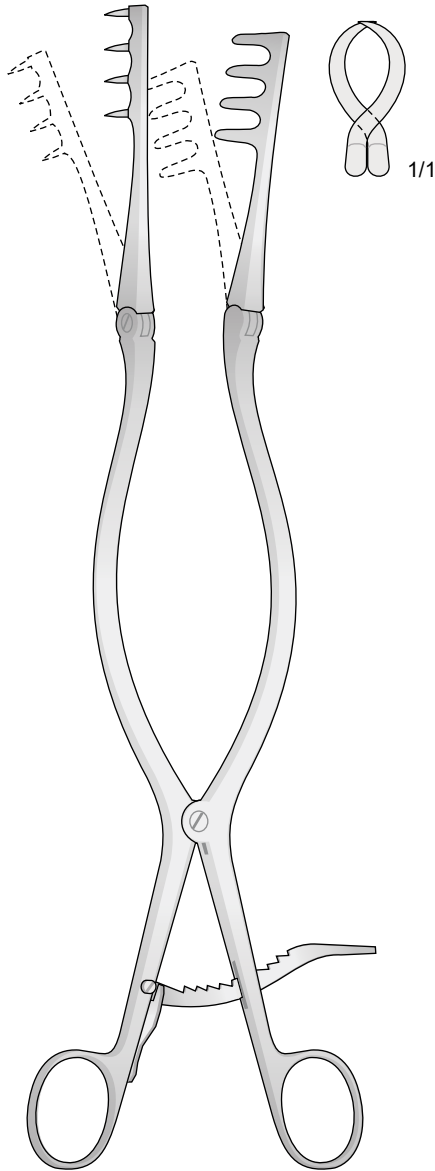

BECKMANN
R 1068-31 31 cm

Semi acuto -Sharp
Halbscharf - Semi pointu
Agudas

4 x 4 Denti
4 x 4 Teeth
4 x 4 Zähne
4 x 4 Dents
4 x 4 Dientes

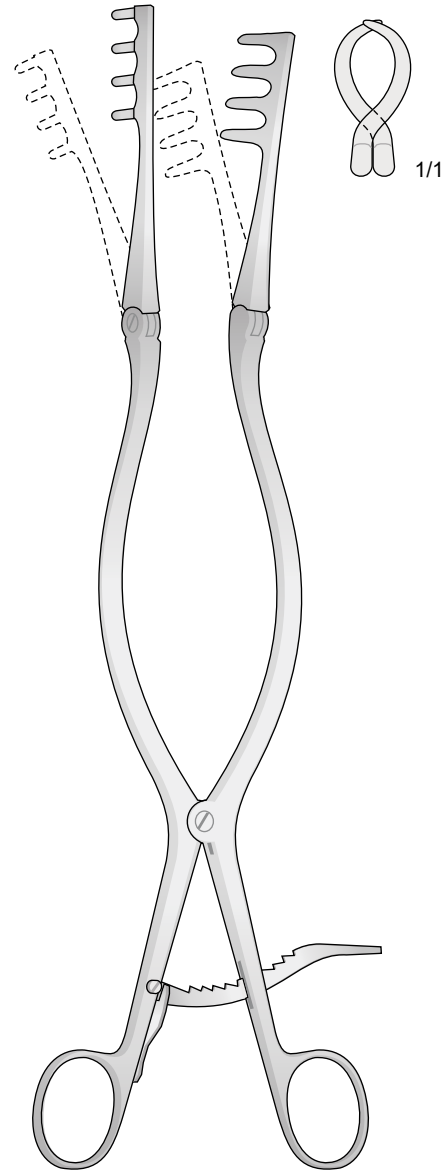

BECKMANN
R 1069-31 31 cm

Smusso - Blunt - Stumpf
 Mousse - Romas

5 x 4 Denti
 5 x 4 Teeth
 5 x 4 Zähne
 5 x 4 Dents
 5 x 4 Dientes

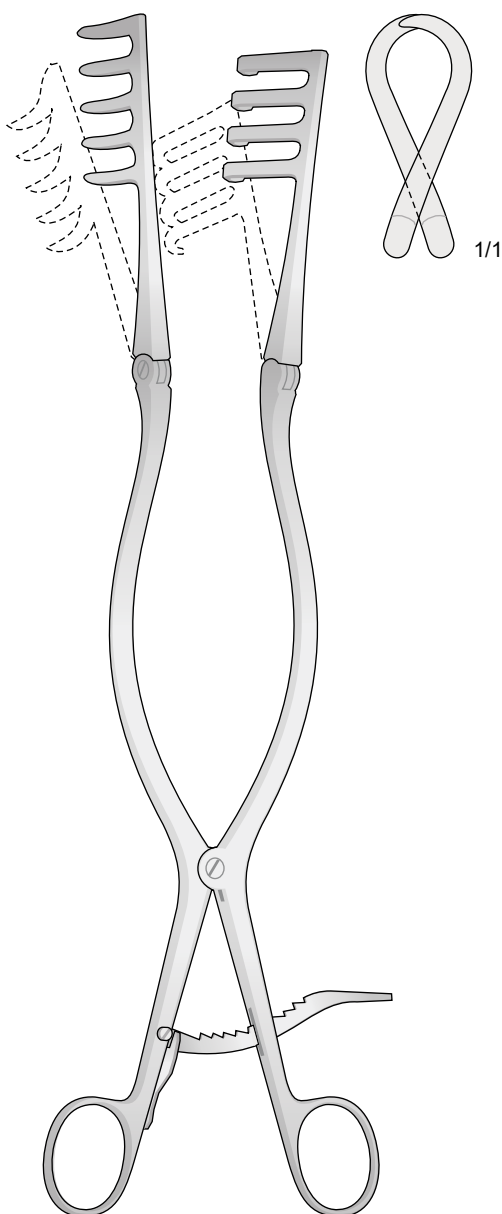

ADSON

R 1070-32 32 cm

Acuto-Sharp-Spitz
 Pointü-Agudas

7 x 7 Denti
 7 x 7 Teeth
 7 x 7 Zähne
 7 x 7 Dents
 7 x 7 Dientes

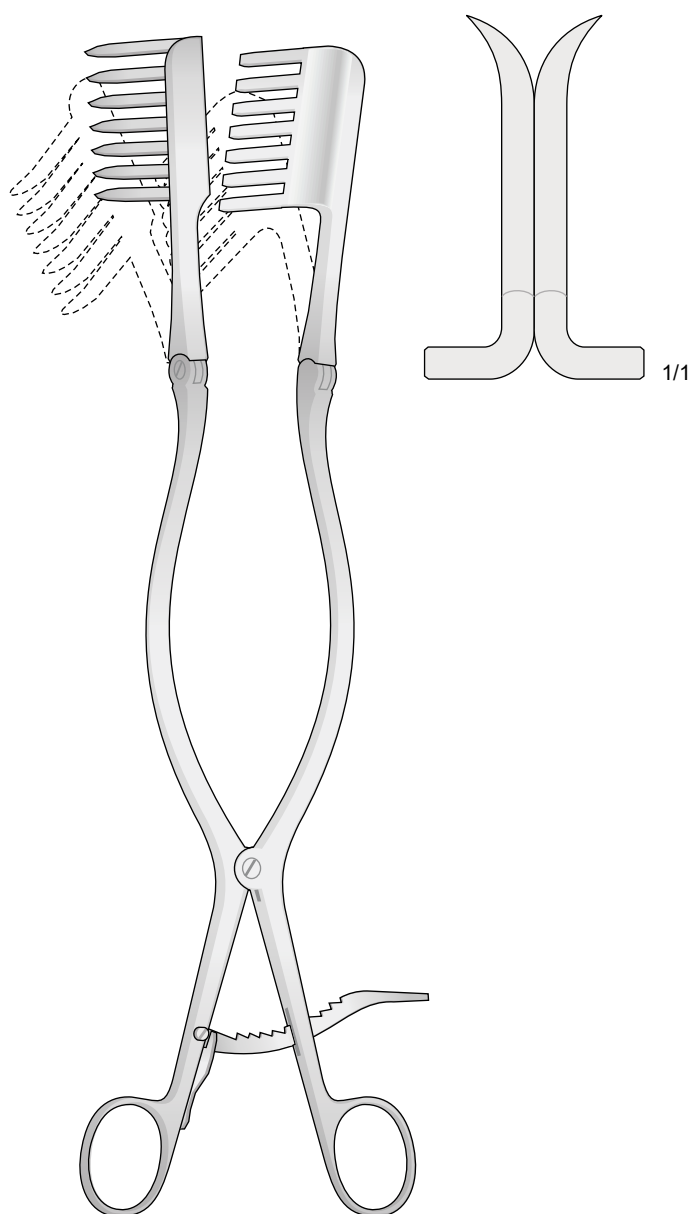

BECKMANN-EATON

R 1071-33 33 cm

Solo divaricatore senza valva
Retractor without blades
Spreizer allein
Separador sin valvas
Ecarteur sans valves

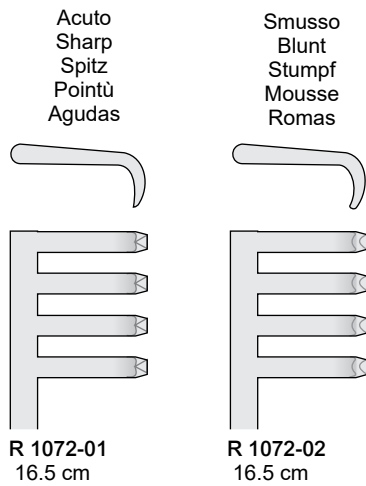

3 x 4 Denti
3 x 4 Teeth
3 x 4 Zähne
3 x 4 Dents
3 x 4 Dientes

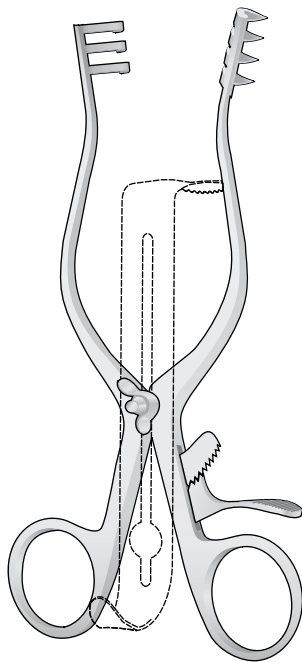

HENLEY
R 1072-01 / R 1072-02

Valve centrali
Center blades
Mittelblatte
Valves centrale
Valvas centrales

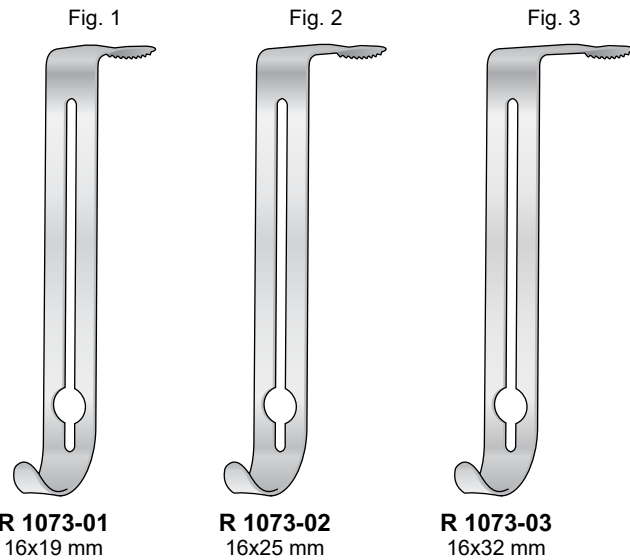

**CLOWARD Modif.
R 1074**
Divaricatore, solo
Retractor, only
Sperrer, allein
Ecarteur, seul
Separador, suelto

**CLOWARD Modif.
R 1075**
Divaricatore, solo
Retractor, only
Sperrer, allein
Ecarteur, seul
Separador, suelto

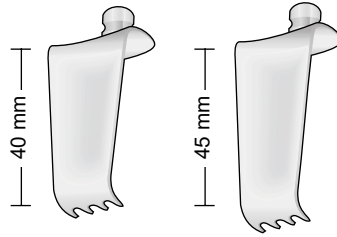

R 1074-01

R 1074-02

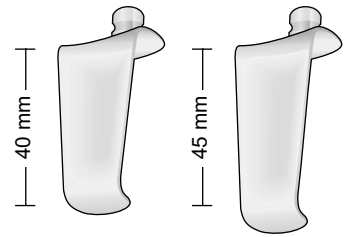

R 1075-01

R 1075-02

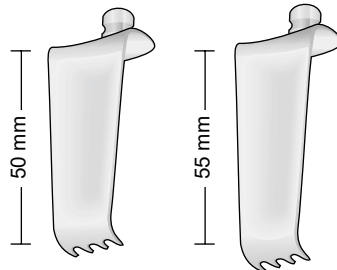

R 1074-03

R 1074-04

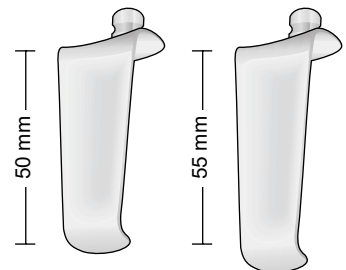

R 1075-03

R 1075-04

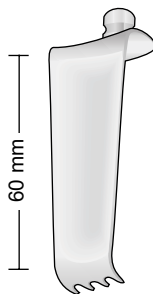

R 1074-05

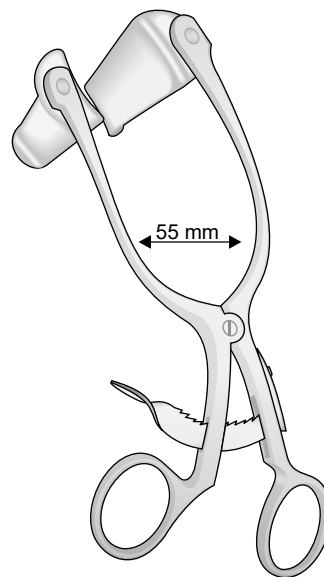

R 1075-16 16 cm

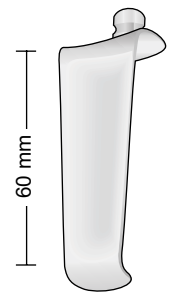

R 1075-05

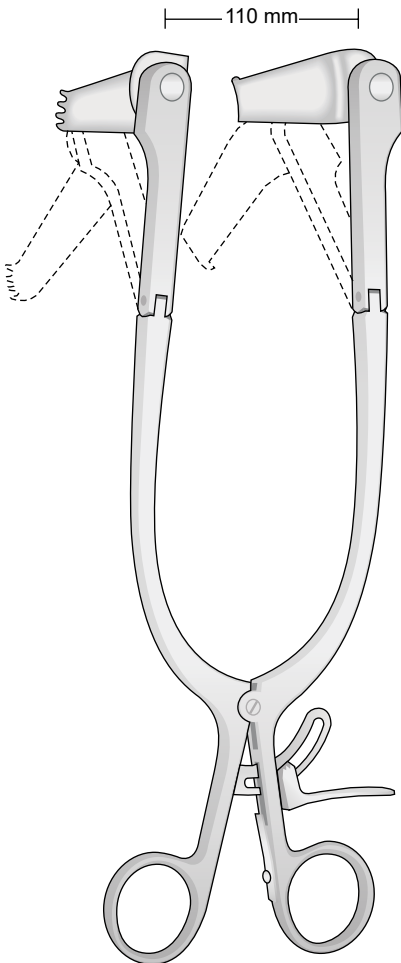

CLOWARD modif.
R 1074-25 25 cm

Completo di 5 valve
Complete with 5 blades
Komplett mit 5 Valven
Complet avec 5 valves
Completo con 5 valvas

Completo di 5 valve
Complete with 5 blades
Komplett mit 5 Valven
Complet avec 5 valves
Completo con 5 valvas

R 1076-18

Completo con un paio di valve
Complete with 1 pairs of blades
Komplett mit 1 Paar Valven
Complete avec 1 paires de valves
Completo con 1 pares de valvas

R 1077-03

Completo con due paia di valve
Complete with 2 pairs of blades
Komplett mit 2 paar valven
Complete avec 2 paires de valves
Completo con 2 pares de valvas

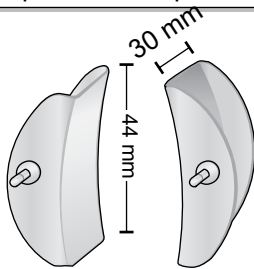

R 1076-01 20x44 mm
R 1076-02 30x44 mm

Valve laterali - paia
Lateral blades - pairs
Seitl. Blätter - paar
Valves latérales - paires
Valvas laterales - pares

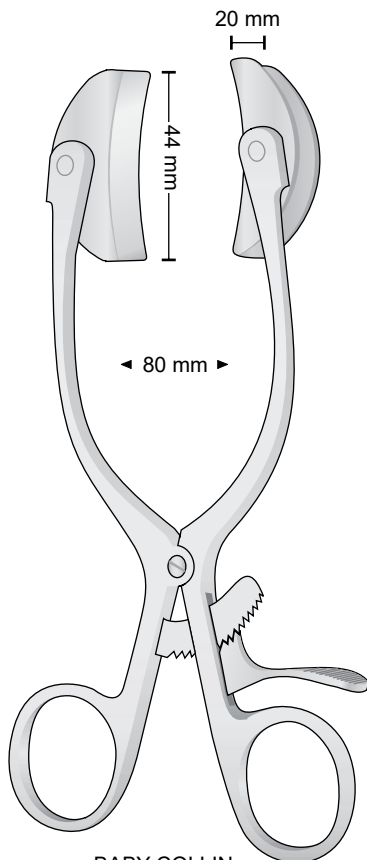

BABY-COLLIN

R 1076-18 18 cm

R 1077-22

Completo con un paio di valve
Complete with 1 pairs of blades
Komplett mit 1 Paar Valven
Complete avec 1 paires de valves
Completo con 1 pares de valvas

R 1077-01

Divaricatore solo
Retractor only
Sperrer allein
Ecarteur seul
Separador suelto

R 1077-02

32x62 mm
Valve laterali - paia
Lateral blades - pairs
Seitl.blätter - paar
Valves latérales - paires
Valvas laterales - pares

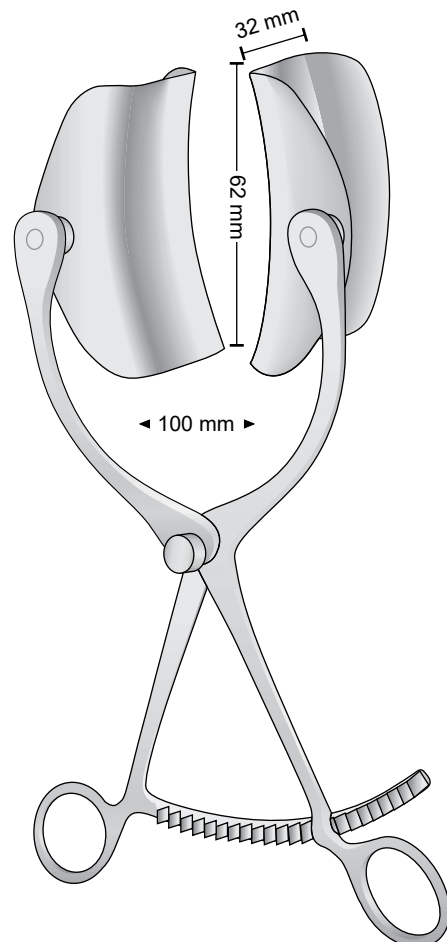

COLLIN

R 1077-22 22 cm

**COLLIN
 AR 1078**
 Completo - Complete
 Komplett - Complets - Completos
 AR 1078-01 _ AR 1078-02 _ AR 1078-03

**COLLIN
 AR 1079**
 Completo - Complete
 Komplett - Complets - Completos
 AR 1079-01 _ AR 1079-02 _ AR 1079-03

**COLLIN
 AR 1080**
 Completo - Complete
 Komplett - Complets - Completos
 AR 1080-01 _ AR 1080-02 _ AR 1080-03

AR 1078-01
 Allargatore solo
 Spreader only
 Sperrer allein
 Ecarteur seul
 Separador suelto

AR 1079-01
 Allargatore solo
 Spreader only
 Sperrer allein
 Ecarteur seul
 Separador suelto

AR 1080-01
 Allargatore solo
 Spreader only
 Sperrer allein
 Ecarteur seul
 Separador suelto

AR 1078-02
 Valva centrale
 Center blade
 Mittelblatt
 Valve centrale
 Valva central
 55 x 55 mm

AR 1079-02
 Valva centrale
 Center blade
 Mittelblatt
 Valve centrale
 Valva central
 55 x 65 mm

AR 1080-02
 Valva centrale
 Center blade
 Mittelblatt
 Valve centrale
 Valva central
 55 x 75 mm

AR 1078-03
 Valve laterali
 Lateral blades
 Seitliche Blätter
 Valves latérales
 Valvas laterales
 32 x 62 mm

AR 1079-03
 Valve laterali
 Lateral blade
 Seitliche Blätter
 Valves latérales
 Valvas laterales
 38 x 80 mm

AR 1080-03
 Valve laterali
 Lateral blade
 Seitliche Blätter
 Valves latérales
 Valvas laterales
 38 x 100 mm

Completo - Complete
 Komplett - Complets - Completos

AR 1078-01 - 135 mm
 AR 1079-01 - 160 mm

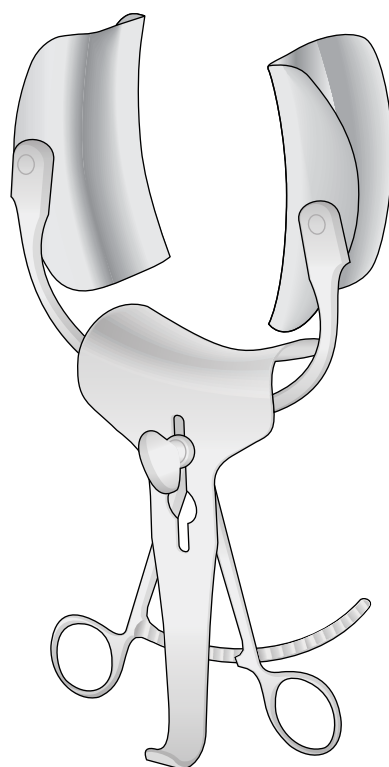

COLLIN
 AR 1078 - AR 1079 - AR 1080

Unità di vendita delle valve: paio
 Sales Unit of blades: pair
 Bestelleinheit der Blätter: Paar
 Unité de commande pour les valves: paire

**COLLIN
AR 1081**
Completo - Complete
Komplett - Complets - Completos
AR 1081-01 _ AR 1081-02 _ AR 1081-03

**COLLIN
AR 1082**
Completo - Complete
Komplett - Complets - Completos
AR 1082-01 _ AR 1082-02 _ AR 1083-03

AR 1081-01
Valve laterali
Lateral blades
Seitliche Blätter
Valves latérales
Valvas laterales
50 x 58 mm

AR 1082-01
Valve laterali
Lateral blades
Seitliche Blätter
Valves latérales
Valvas laterales
62 x 80 mm

AR 1082-02
Valva centrale
Center blade
Mittelblatt
Valve centrale
Valva central
62 x 70 mm

AR 1082-03
Allargatore solo
Spreader only
Sperrer allein
Ecarteur seul
Separador suelto

Completo - Complete
Komplett - Complets - Completos

210 mm

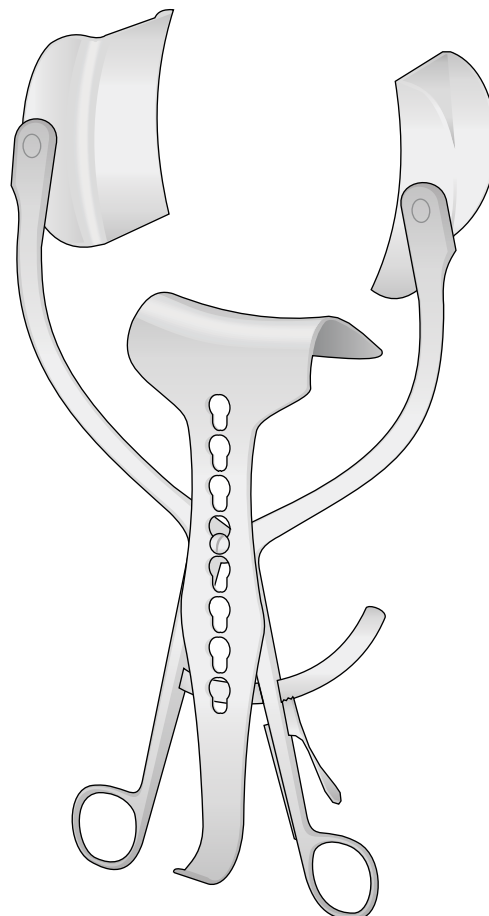

Unità di vendita delle valve: paio
Sales Unit of blades: pair
Bestelleinheit der Blätter: Paar
Unité de commande pour les valves: paire

**COLLIN
AR 1081 - AR 1082**

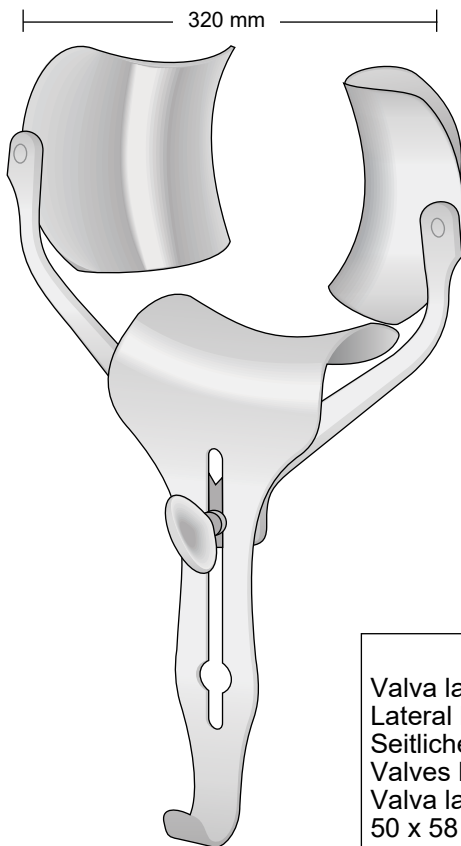

**RICARD
 AR 1083**
 Completo - Complete
 Komplett - Complet - Completo

**RICARD
 AR 1084**
 Completo - Complete
 Komplett - Complet - Completo

AR 1083-01 - AR 1084-01
 Divaricatore solo
 Retractor only
 Sperrer allein
 Ecarteur seul
 Separador suelto

AR 1083-02
 Valva centrale
 Center blade
 Mittelblatt
 Valve centrale
 Valva central
 55 x 70 mm

AR 1084-02
 Valva centrale
 Center blade
 Mittelblatt
 Valve centrale
 Valva central
 80 x 90 mm

Valva laterale
 Lateral blade
 Seitliche Blätter
 Valves latérales
 Valva laterales
 50 x 58 mm

AR 1083-03
 Valva laterale
 Lateral blade
 Seitliche Blätter
 Valves latérales
 Valva laterales
 60 x 80 mm

AR 1084-03
 Valva laterale
 Lateral blade
 Seitliche Blätter
 Valves latérales
 Valva laterales
 72 x 85 mm

RICARD
AR 1083 Completo - Complete
 Komplett - Complet - Completo
AR 1084 Completo - Complete
 Komplett - Complet - Completo

Completo - Complete
 Komplett - Complete - Completos

Unità di vendita delle valve: paio
 Sales Unit of blades: pair
 Bestelleinheit der Blätter: Paar
 Unité de commande pour les valves: paire

275 mm

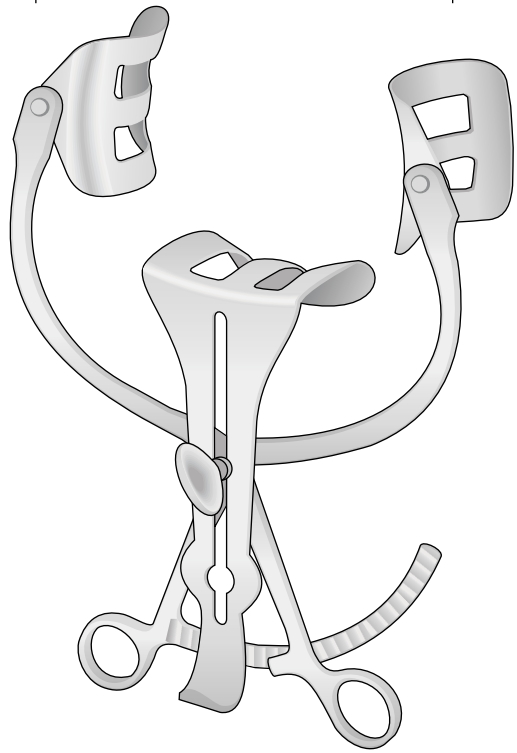

AR 1085-01
 Divaricatore solo
 Retractor only
 Sperrer allein
 Ecarteur seul
 Separador suelto

AR 1085-02
 59 x 80 mm
 Valva laterali
 Lateral blades
 Seitliche Blätter
 Valves latérales
 Valvas laterales

AR 1085-03
 74 x 82 mm
 Valva centrale
 Center blade
 Mittelblatt
 Valve centrale
 Valva central

**HOLZBACH
 AR 1085**



Strumento solo, senza valve
Frame only - Instrumente allein, ohne Blätter
Cadre seul - Cuadro solo

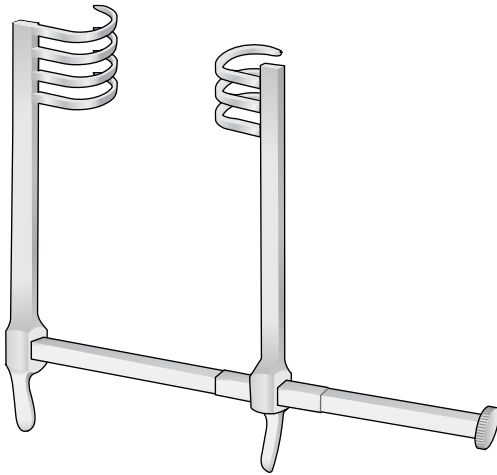

FRAZIER
AR 1086

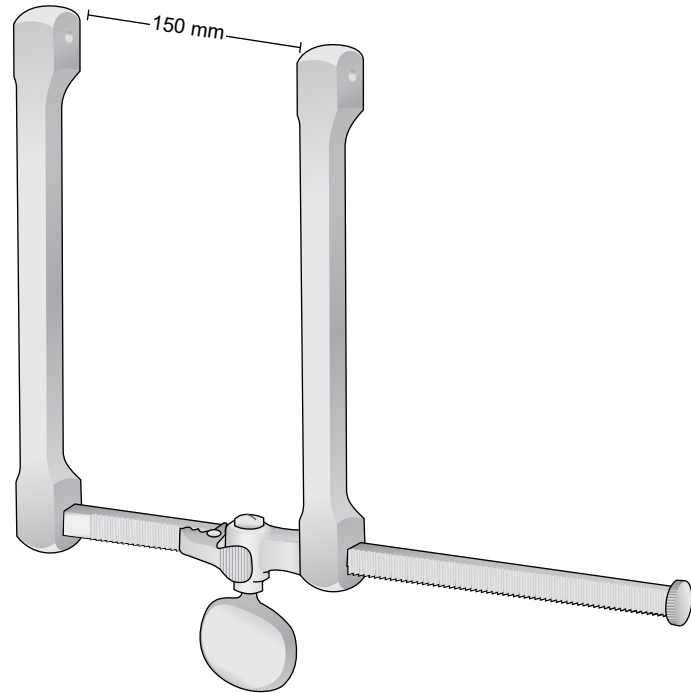

SCOVILLE
AR 1087

Strumento solo, senza valve
Frame only, without blade
Instrumente allein, ohne Blätter
Cadre seul, sans valves
Cuadro solo, no valvas

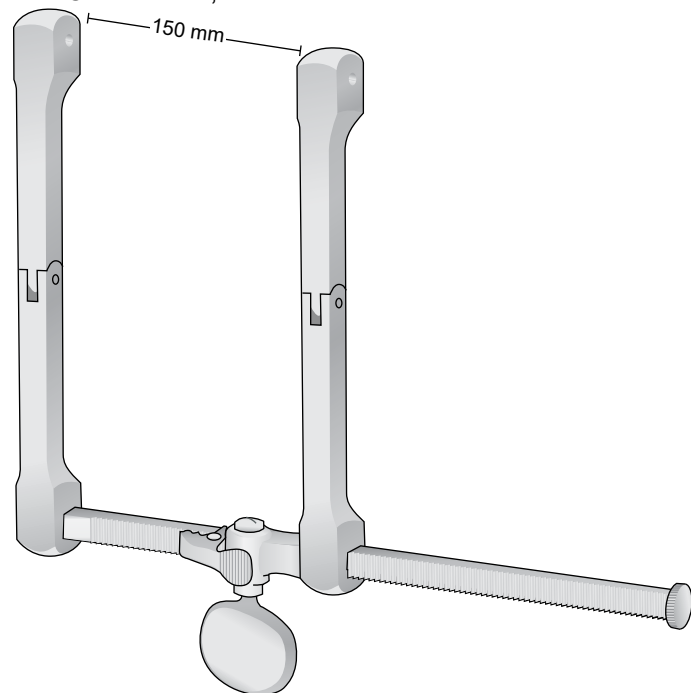

SCOVILLE-HAVERFIELD
AR 1088

Acuto
 Scharp
 Spitz
 Pointù
 Agudo

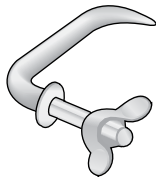

SCOVILLE
LR 1089-05
 50 mm

Acuto
 Scharp
 Spitz
 Pointù
 Agudo

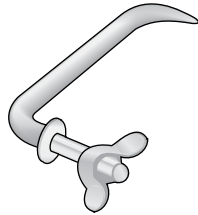

SCOVILLE
LR 1089-07
 70 mm

Smusso
 Blunt
 Stumpf
 Mousse
 Romo

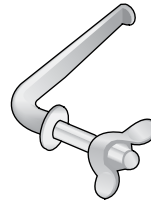

SCOVILLE
LR 1090-05
 50 mm

Smusso
 Blunt
 Stumpf
 Mousse
 Romo

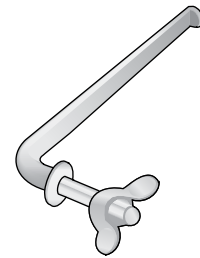

SCOVILLE
LR 1090-07
 70 mm

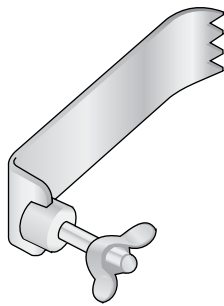

SCOVILLE

Code	Size
LR 1091-01	50x25 mm
LR 1091-02	50x50 mm
LR 1091-03	57x38 mm
LR 1091-04	64x25 mm
LR 1091-05	64x50 mm
LR 1091-06	67x30 mm
LR 1091-07	75x25 mm
LR 1091-08	75x50 mm
LR 1091-09	88x25 mm
LR 1091-10	100x50 mm

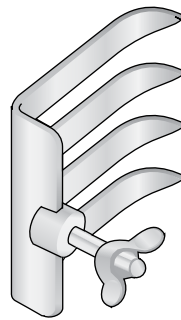

TAYLOR

Code	Size
LR 1092-01	48x50 mm
LR 1092-02	64x50 mm
LR 1092-03	64x64 mm
LR 1092-04	80x57 mm

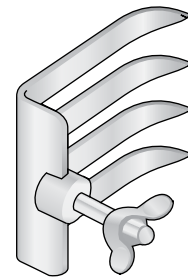

SCOVILLE

Code	Size
LR 1093-01	41x38 mm
LR 1093-02	67x44 mm

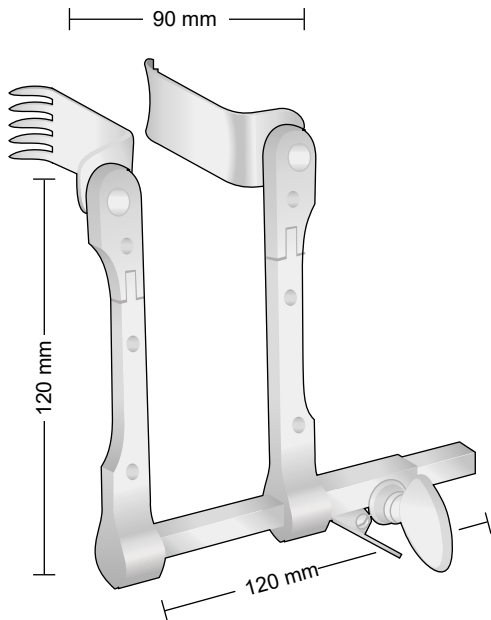

**CASPAR
LR 1094**

Completo con 5 + 5 valve
Complete with 5 + 5 blade
Komplett mit 5 + 5 Blätter
Complet avec 5 + 5 valves
Completo con 5 + 5 valvas

LR 1094-01

Divaricatore solo
Retractor only
Sperrer allein
Ecarteur seul
Separador suelto

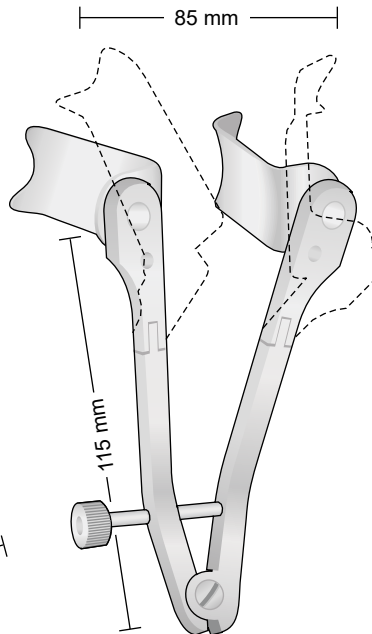

**CASPAR
LR 1095**

Completo con 5 valve
Complete with 5 blade
Komplett mit 5 Blätter
Complet avec 5 valves
Completo con 5 valvas

LR 1095-01

Divaricatore solo
Retractor only
Sperrer allein
Ecarteur seul
Separador suelto

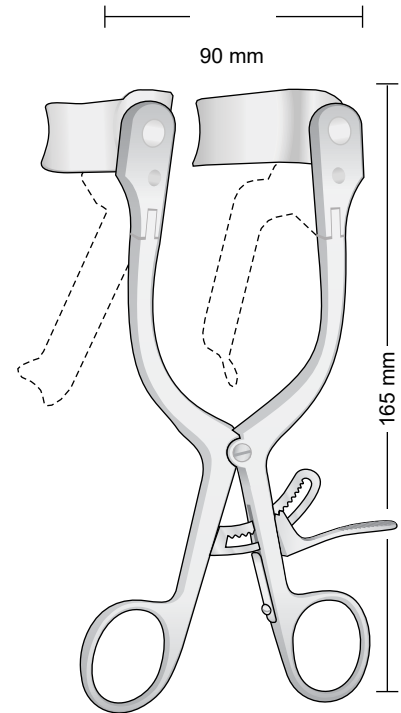

**CASPAR
LR 1096**

Completo con 5 valve
Complete with 5 blade
Komplett mit 5 Blätter
Complet avec 5 valves
Completo con 5 valvas

LR 1096-01

Divaricatore solo
Retractor only
Sperrer allein
Ecarteur seul
Separador suelto

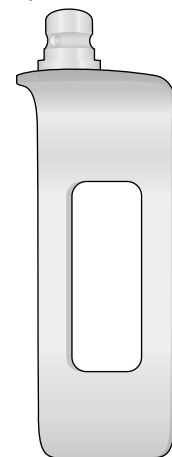
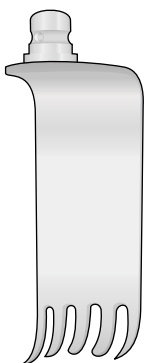

Code	Size
LR 1097-01	40x23 mm
LR 1097-02	45x23 mm
LR 1097-03	50x23 mm
LR 1097-04	55x23 mm
LR 1097-05	60x23 mm

Code	Size
LR 1098-01	40x23 mm
LR 1098-02	45x23 mm
LR 1098-03	50x23 mm
LR 1098-04	55x23 mm
LR 1098-05	60x23 mm

Code	Size
LR 1099-01	45x23 mm
LR 1099-02	50x23 mm
LR 1099-03	55x23 mm
LR 1099-04	60x23 mm
LR 1099-05	65x23 mm

Code	Size
LR 1100-01	50x25 mm
LR 1100-02	60x25 mm

Valve in titanio
 Titanium blades
 Titan-valven
 Valves en titane
 Valvas in titanio

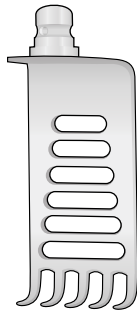

Code	Size
RV 1101-01	25x24 mm
RV 1101-02	30x24 mm
RV 1101-03	35x24 mm
RV 1101-04	40x24 mm
RV 1101-05	45x24 mm
RV 1101-06	25x24 mm
RV 1101-07	30x24 mm
RV 1101-08	35x24 mm
RV 1101-09	40x24 mm
RV 1101-10	45x24 mm

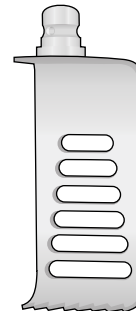

Code	Size
RV 1102-01	25x24 mm
RV 1102-02	30x24 mm
RV 1102-03	35x24 mm
RV 1102-04	40x24 mm
RV 1102-05	45x24 mm
RV 1102-06	50x24 mm
RV 1102-07	55x24 mm
RV 1102-08	60x24 mm
RV 1102-09	65x24 mm
RV 1102-10	70x24 mm

Pinzetta per la sostituzione delle valve
 con i bloccaggi rapidi a sfera
 Blade ejector for changing the blades
 with ball snap closure
 Pinzette zum wechseln der valven
 mit kugelschnellverschluss
 Pincas pour changer les valves munies
 du système de verrouillage rapide à billes

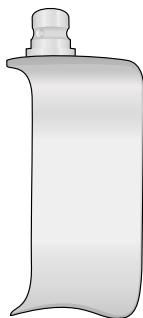

Code	Size
RV 1103-01	30x24 mm
RV 1103-02	35x24 mm
RV 1103-03	40x24 mm
RV 1103-04	45x24 mm
RV 1103-05	50x24 mm
RV 1103-06	55x24 mm
RV 1103-07	60x24 mm
RV 1103-08	65x24 mm
RV 1103-09	70x24 mm
RV 1103-10	75x24 mm

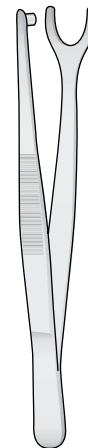

RV 1104-11 11.5 cm

Oberfläche schwarz beschichtet
Surface black-coated

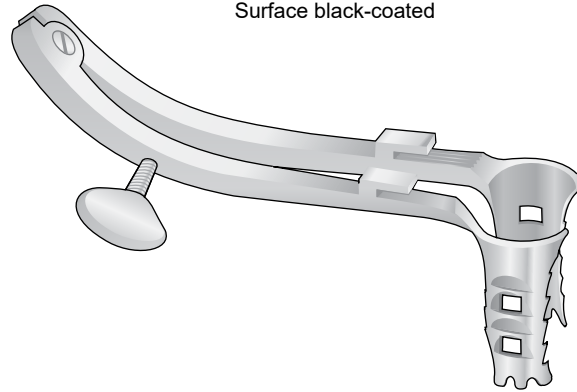

CASPAR

RV 1105-01 / RV 1105-08

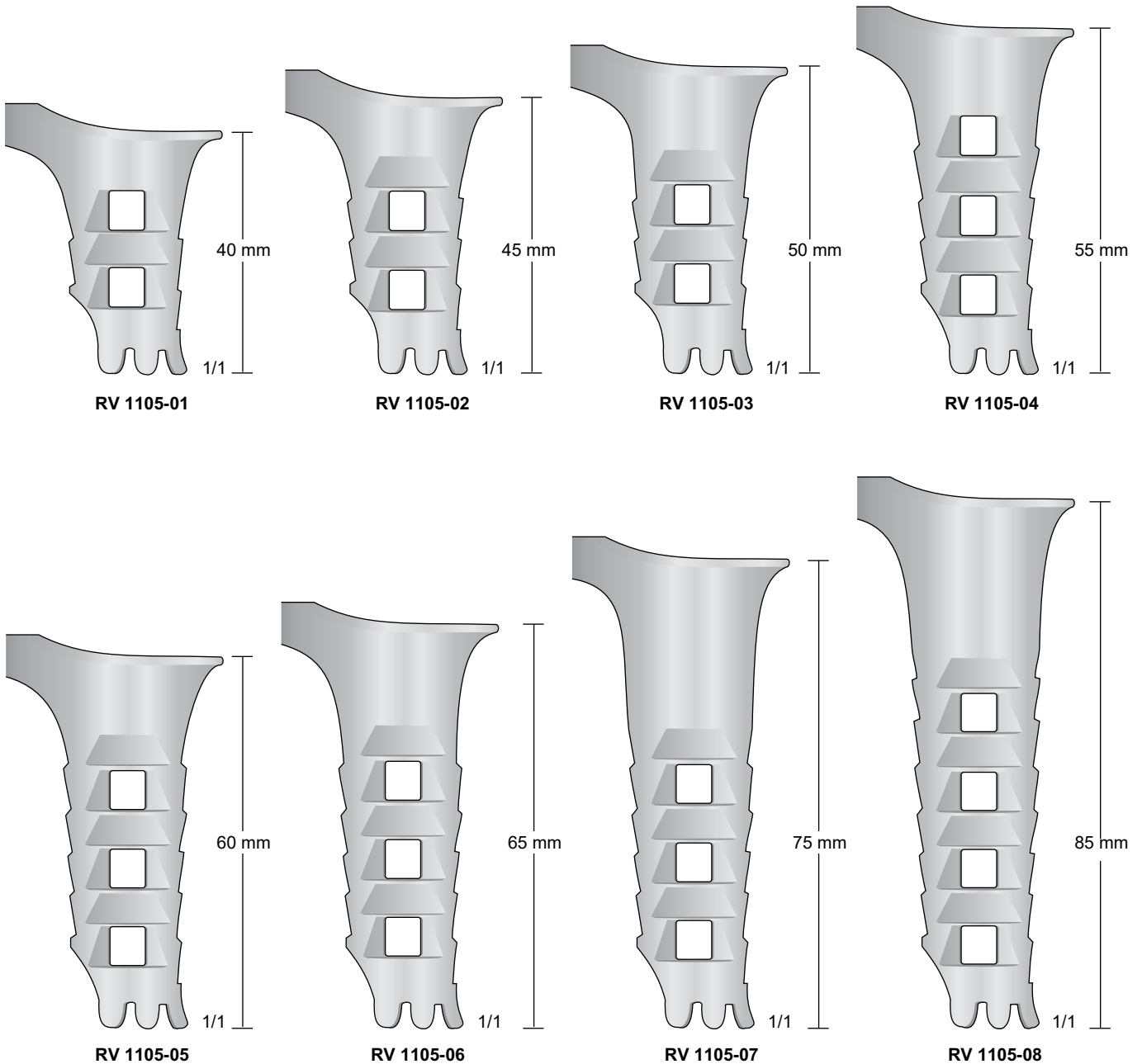

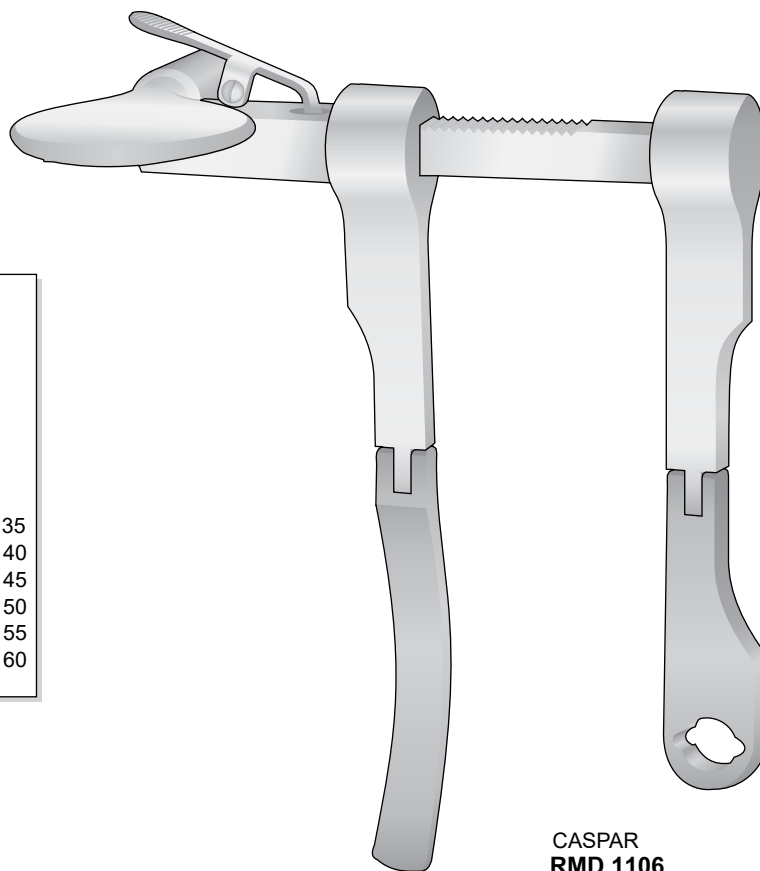

**CASPAR
 RMD 1107**
 Divaricatore completo di
 Retractor complete with
 Sperrer komplett mit
 Ecarteur complet avec
 Separador completo con

RMD 1107-01 Valva anti-riflesso mm. 35
RMD 1107-02 Valva anti-riflesso mm. 40
RMD 1107-03 Valva anti-riflesso mm. 45
RMD 1107-04 Valva anti-riflesso mm. 50
RMD 1107-05 Valva anti-riflesso mm. 55
RMD 1107-06 Valva anti-riflesso mm. 60

RMD 1106
 Divaricatore solo
 Retractor only
 Sperrer allein
 Ecarteur seul
 Separador suelto

CASPAR
 RMD 1106

Valve anti-riflesso

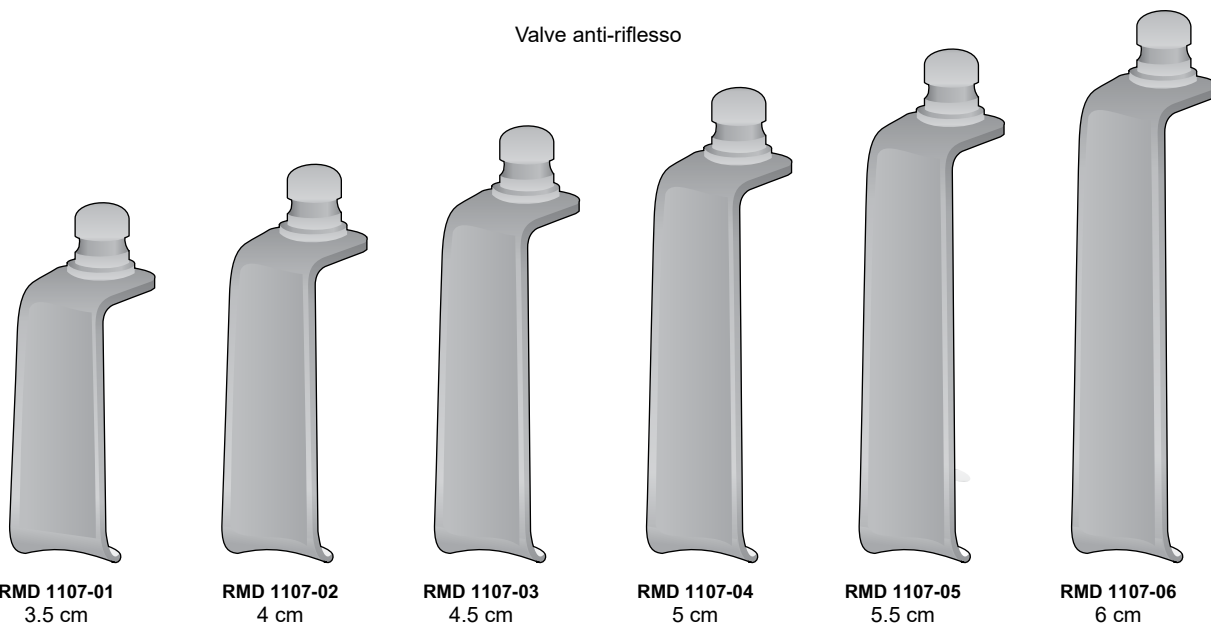

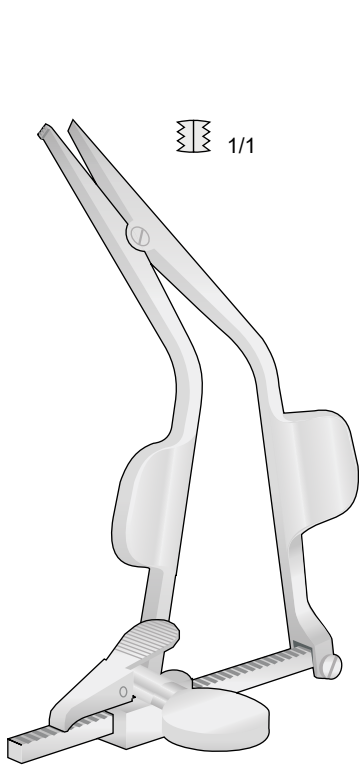

CLOWARD
RMD 1108-15 15 cm

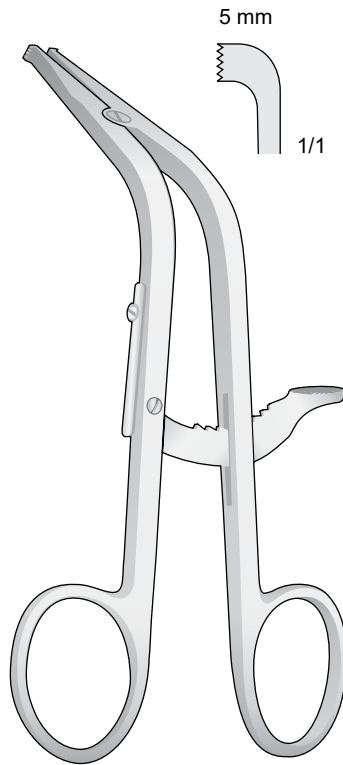

CLOWARD
RMD 1109-16 16 cm

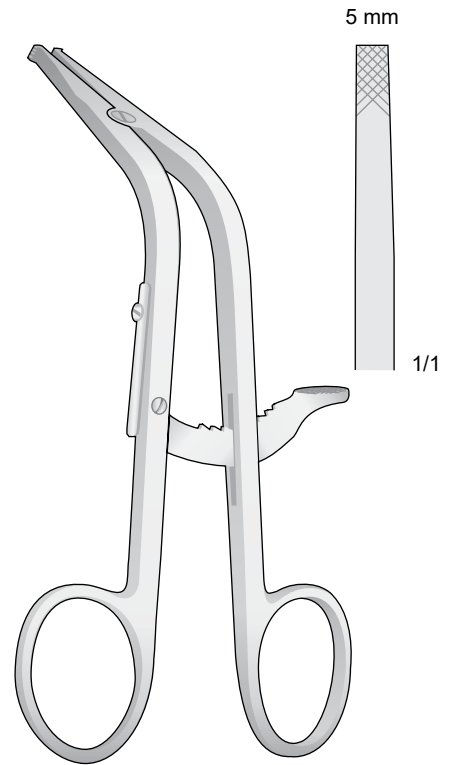

CLOWARD
RMD 1110-16 16 cm

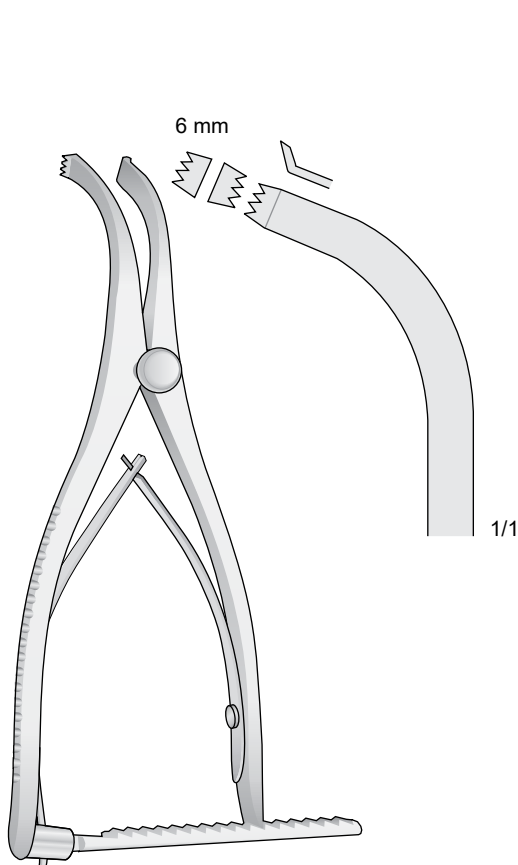

INGE
RMD 1111-16 16 cm

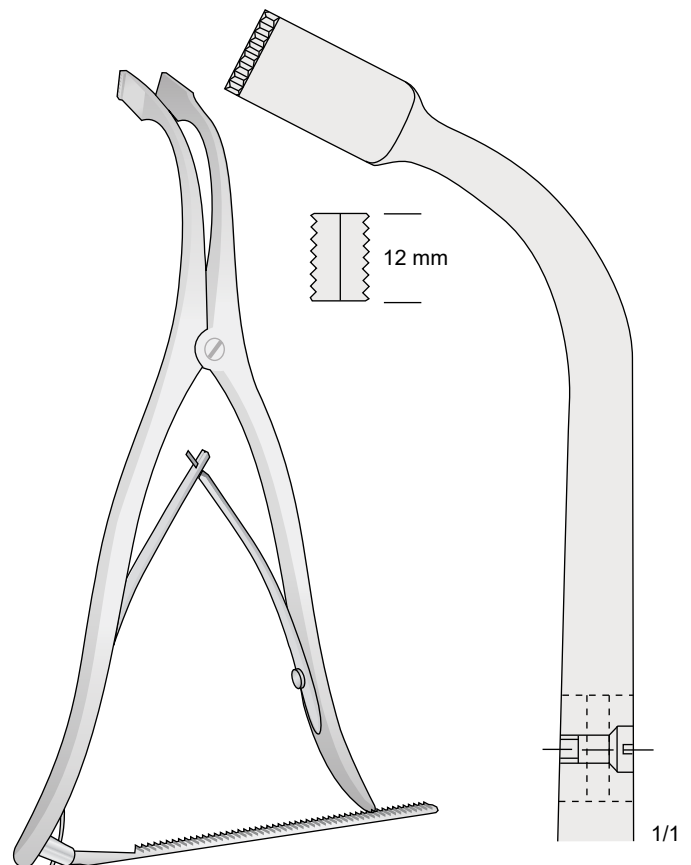

INGE
RMD 1112-27 27.5 cm

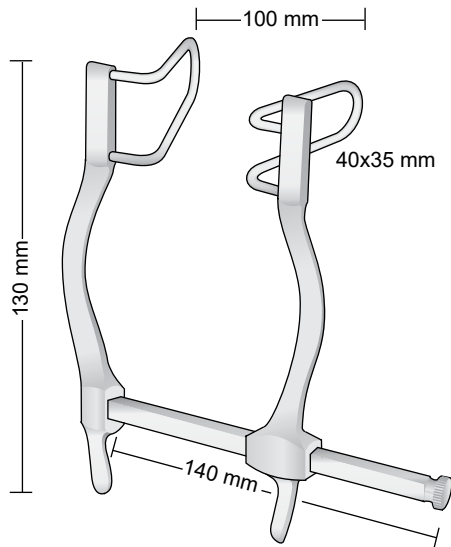

**GOSSET
 AR 1113**

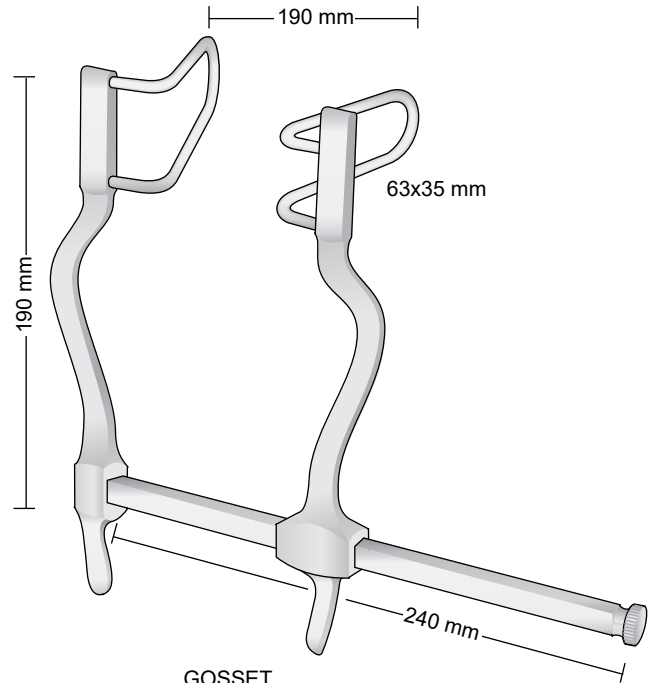

**GOSSET
 AR 1114**

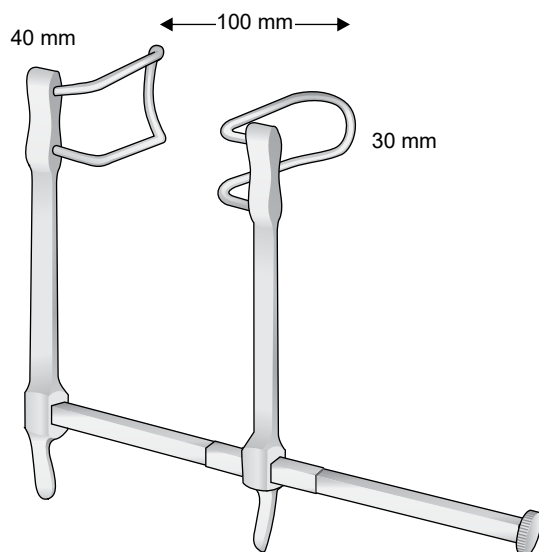

**GOSSET
 AR 1115**

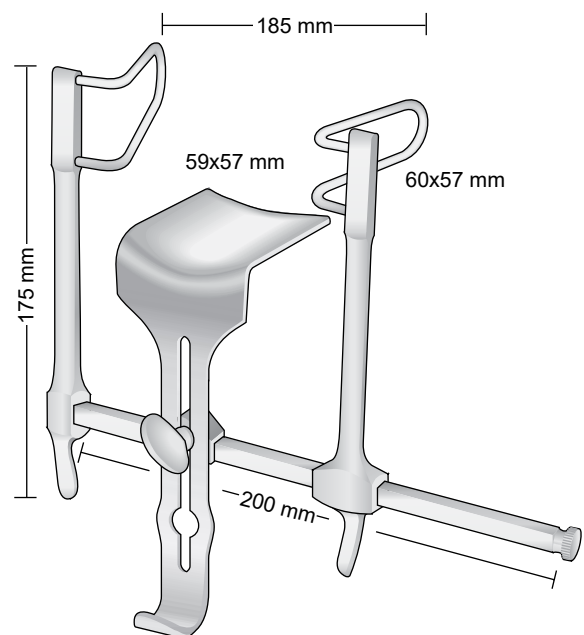

**GOSSET
 AR 1116**

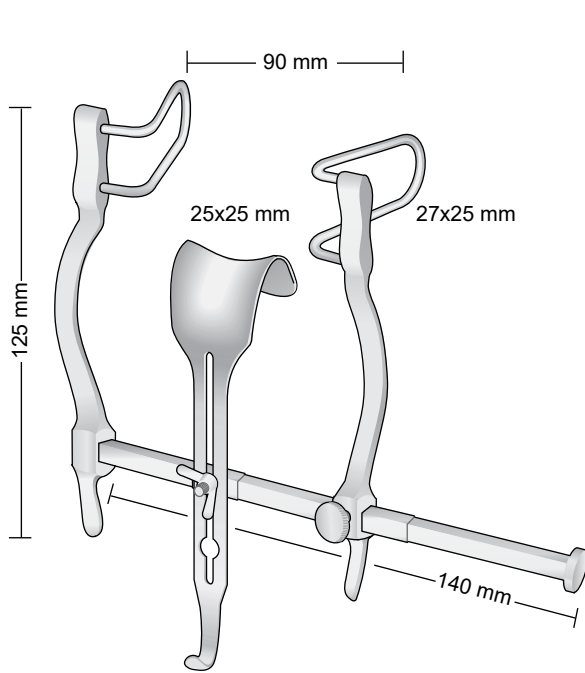

**BALFOUR-BABY
AR 1117**

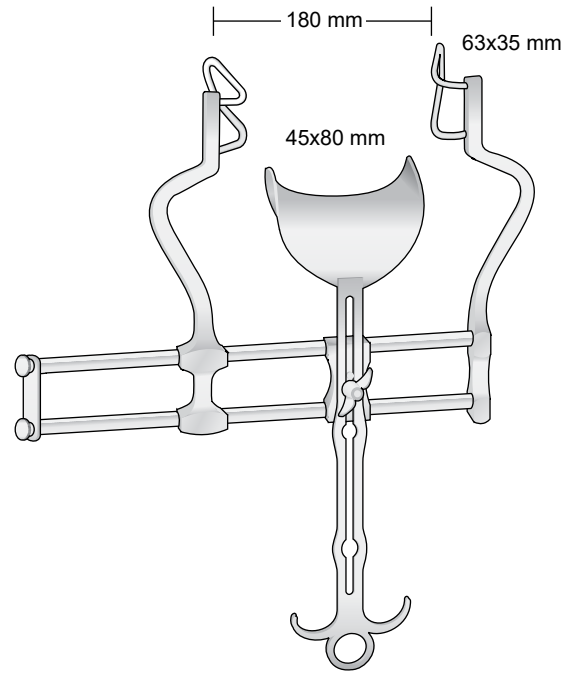

**BALFOUR
AR 1118**

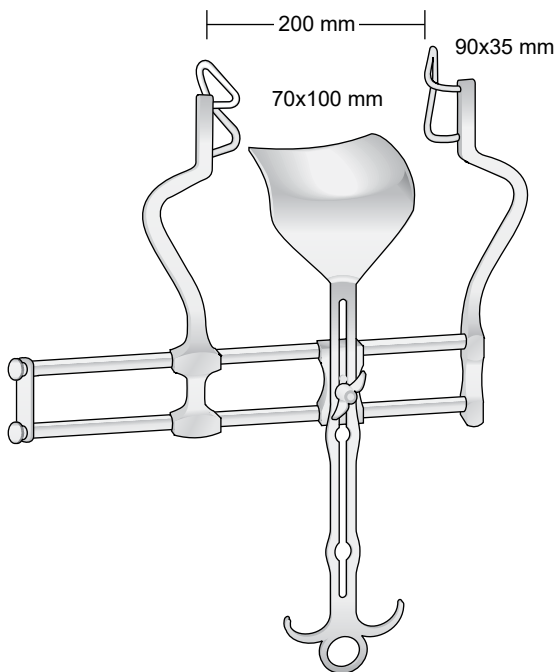

**BALFOUR
AR 1119**

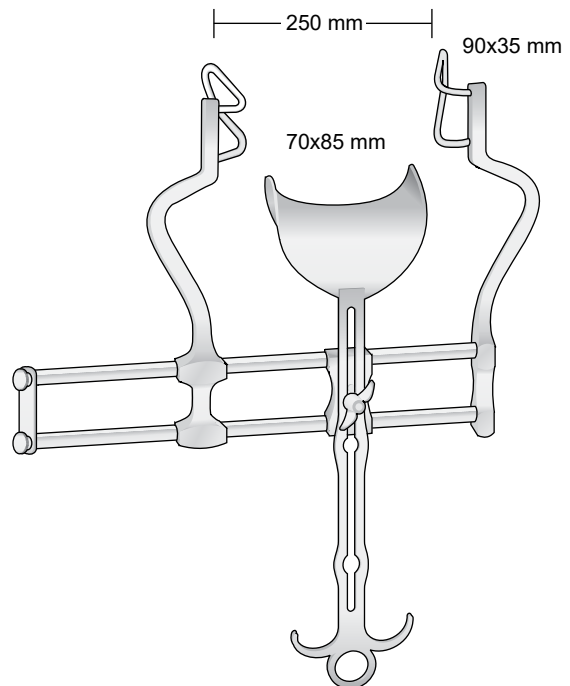

**BALFOUR
AR 1120**

Valva centrale - Center blade
 Mittelblatt - Valve centrale - Valva central

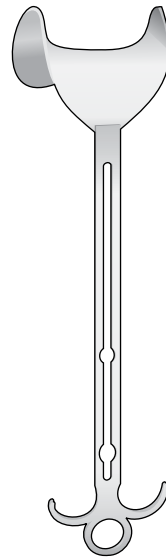

BALFOUR

AR 1122 45x80 mm

AR 1121-01
 Completo con:
 Complete with:
 Komplett mit:
 Complet avec:
 Completos con:
AR 1121-02_AR 1122_AR 1123-01

Valve laterali - paio
 Lateral blades - pair
 Seitliche Blätter - Paar
 Valves latérales - paires
 Valvas laterales - pares

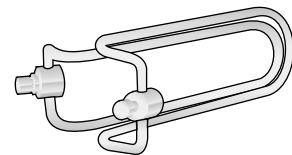

Code	Size
AR 1123-01	50 mm
AR 1123-02	60 mm
AR 1123-03	75 mm
AR 1123-04	90 mm

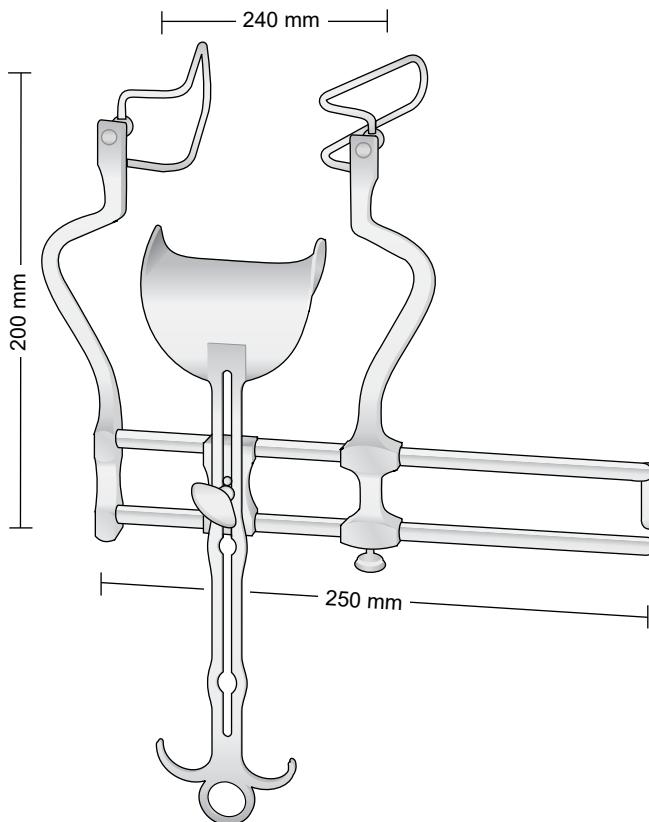

BALFOUR
AR 1121

AR 1121-02
 BALFOUR
 Divaricatore solo
 Retractor only
 Sperrer allein
 Ecarteur seul
 Separador suelto

AR 1122
 Valva centrale
 Center blade
 Mittelblatt
 Valve centrale
 Valva central
 45 x 80 mm

AR 1121-03
 Valva centrale
 Center blade
 Mittelblatt
 Valve centrale
 Valva central
 60 x 80 mm

AR 1121-04
 Valva centrale
 Center blade
 Mittelblatt
 Valve centrale
 Valva central
 80 x 80 mm

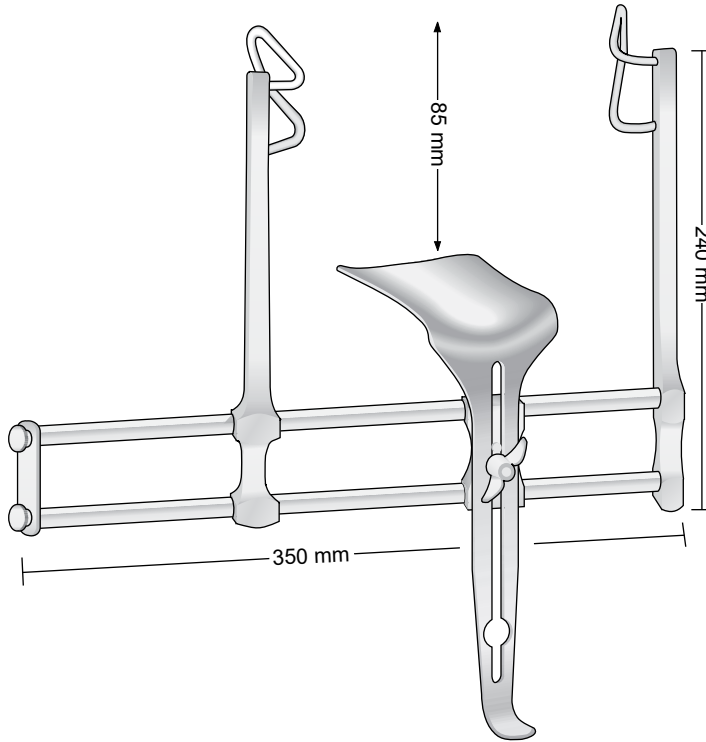

BALFOUR MODIF.
AR 1124

45 X 85 mm

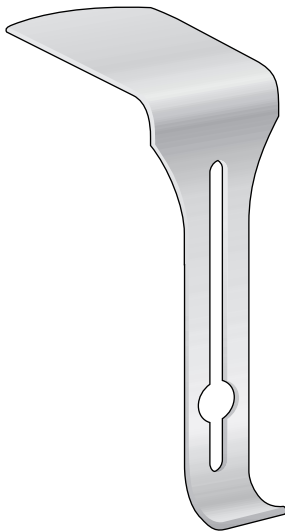

AR 1124-17 17 cm

75 X 65 mm

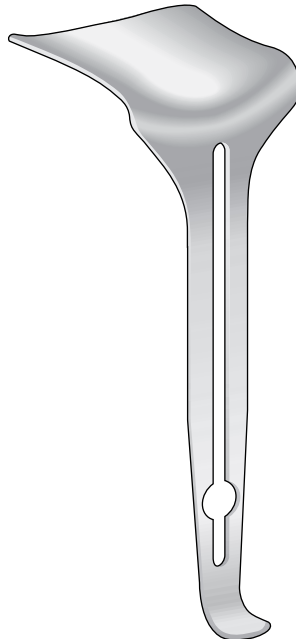

AR 1124-23 23 cm

70 X 100 mm

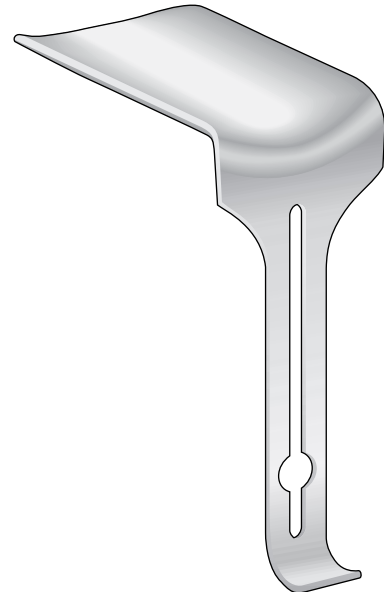

AR 1124-20 20 cm

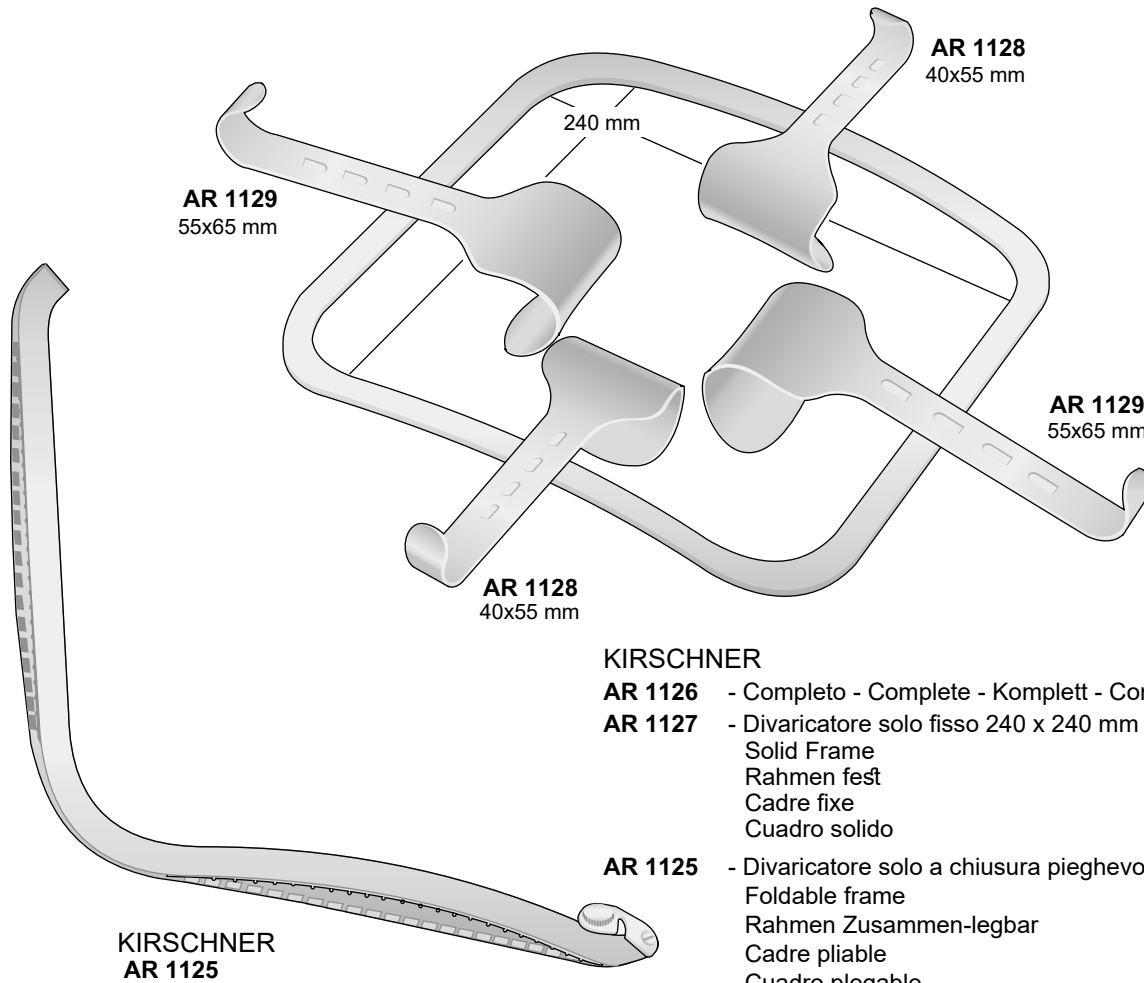

KIRSCHNER

- AR 1126** - Completo - Complete - Komplet - Complet - Completo
- AR 1127** - Divaricatore solo fisso 240 x 240 mm
 Solid Frame
 Rahmen fest
 Cadre fixe
 Cuadro solido
- AR 1125** - Divaricatore solo a chiusura pieghevole 240 x 240 mm
 Foldable frame
 Rahmen Zusammen-legbar
 Cadre pliable
 Cuadro plegable

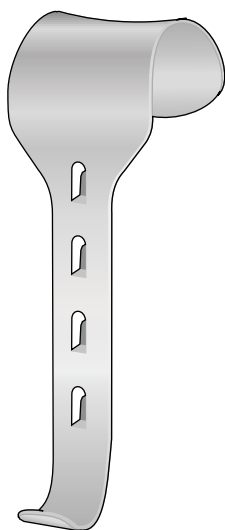

KIRSCHNER
AR 1128
 40 x 55 mm

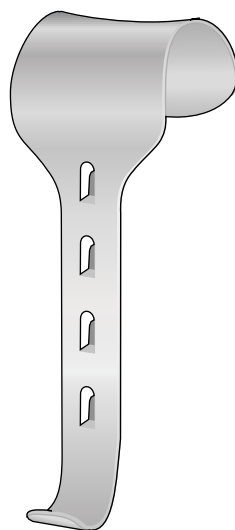

KIRSCHNER
AR 1129 - 50 x 65 mm
AR 1130 - 65 x 80 mm

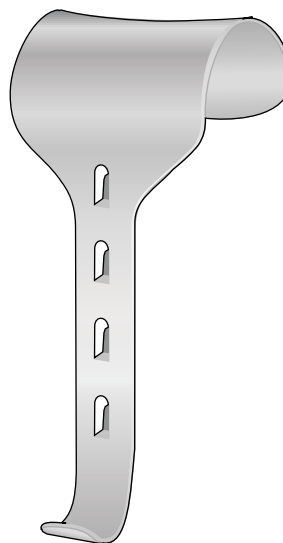

KIRSCHNER
AR 1131 - 60 x 85 mm
AR 1132 - 78 x 65 mm
AR 1133 - 90 x 65 mm

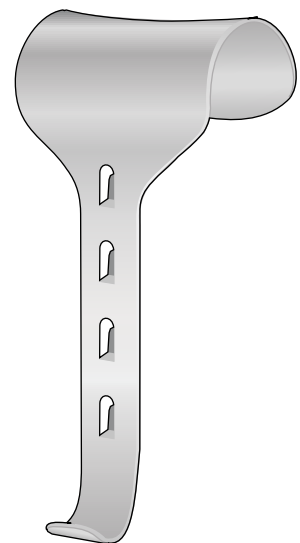

KIRSCHNER
AR 1134 - 80 x 80 mm
AR 1135 - 80 x 90 mm
AR 1136 - 90 x 90 mm

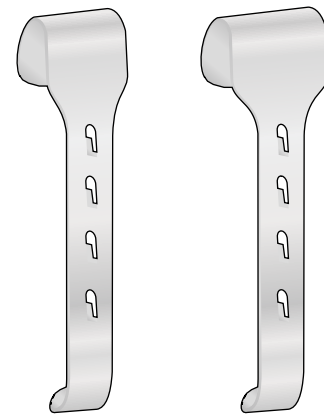
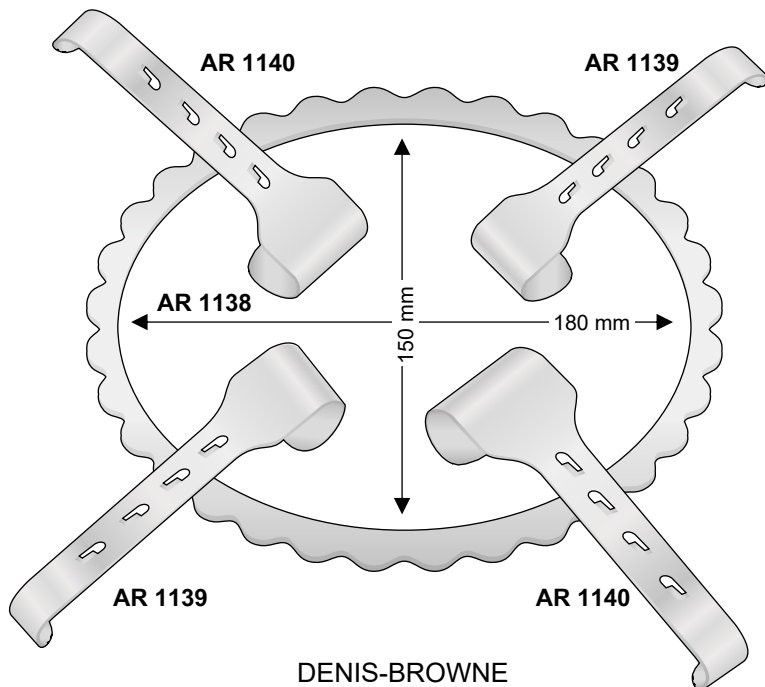

AR 1141
20 x 30 mm

AR 1142
20 x 40 mm

DENIS-BROWNE
AR 1137

Set completo per bambini
Set complete for children
Komplettset für kinder
Set complete pour enfants
Set completo para niños

- AR 1138** - 1 Cornice 180 x 150 mm
- AR 1141** - 2 Valve 20 x 30 mm
- AR 1142** - 2 Valve 20 x 40 mm

AR 1138

180 x 150 mm
Cornice sola
Frame only
Rahmen allein
Ecarteur seul
Separador suelto
Per bambini - For children
Für kinder - Pour enfants
Para niños

DENIS-BROWNE
AR 1143

Set completo per adulti
Set complete for adults
Komplettset für Erwachsene
Set complete pour adultes
Set completo para adultos

- AR 1144** - 1 Cornice 255 x 180 mm
- AR 1139** - 2 Valve 40 x 30 mm
- AR 1140** - 2 Valve 40 x 40 mm

AR 1144

255 x 180 mm
Cornice sola
Frame only
Rahmen allein
Ecarteur seul
Separador suelto
Per adulti - For adults
Für erwachsene - Pour adultes
Para adultos

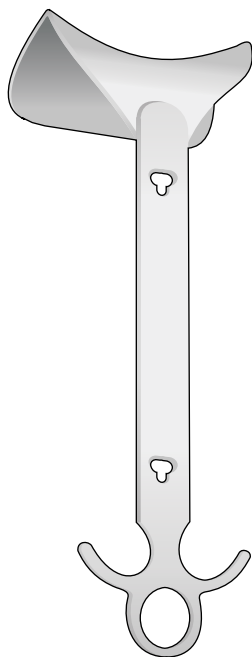

ROCHARD 27 cm

Code	Size
AR 1145-01	60x95 mm
AR 1145-02	60x105 mm
AR 1145-03	60x120 mm
AR 1145-04	60x135 mm
AR 1145-05	60x155 mm

Dispositivo di fissaggio
 Fixation device
 Fixiervorrichtung
 Dispositif de fixation articulé
 Dispositivo de fijación

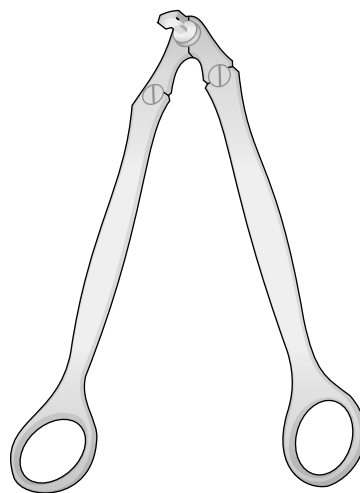

ROCHARD

AR 1146-19 19 cm

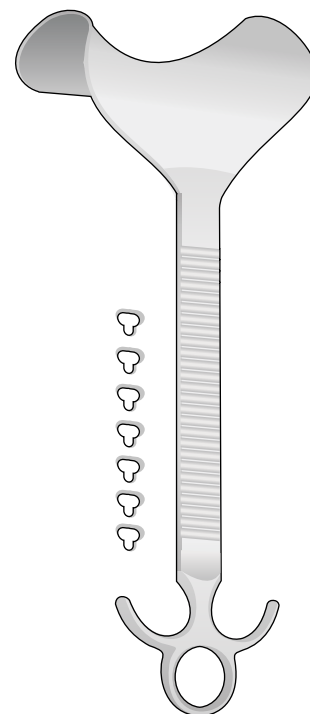

DOYEN 28 cm

Code	Size
AR 1147-01	50x85 mm
AR 1147-02	48x90 mm
AR 1147-03	48x105 mm
AR 1147-04	48x120 mm
AR 1147-05	48x135 mm

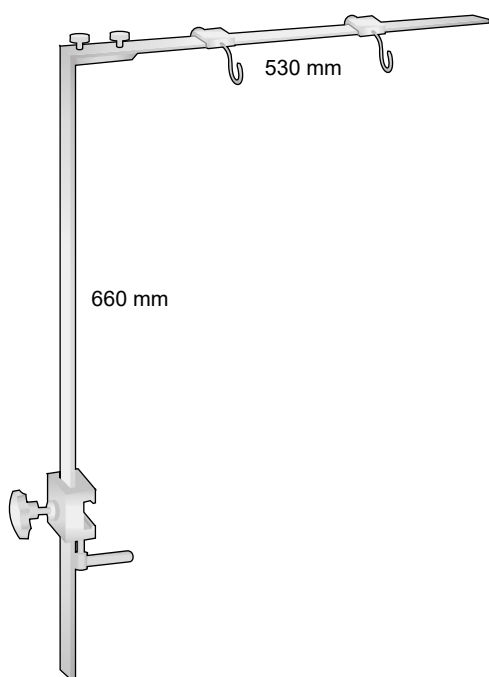

ROCHARD
 AR 1148

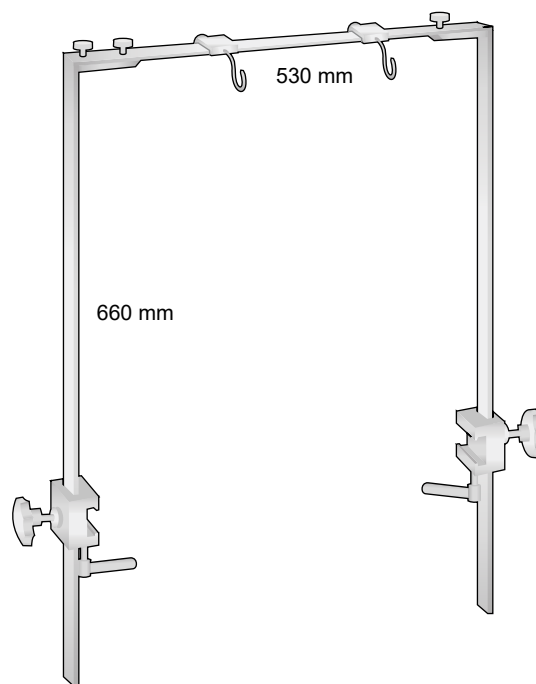

ROCHARD
 AR 1149

AR 1151
Valva regolabile
Large blade

AR 1152
Valva piccola
Small blade

AR 1153
Contrappeso + catenella
Weight with chain

Divaricatore per anca
Retractor with chain
Wundhaken mit Kette
Completo - Complete - Komplet
Complete - Completos

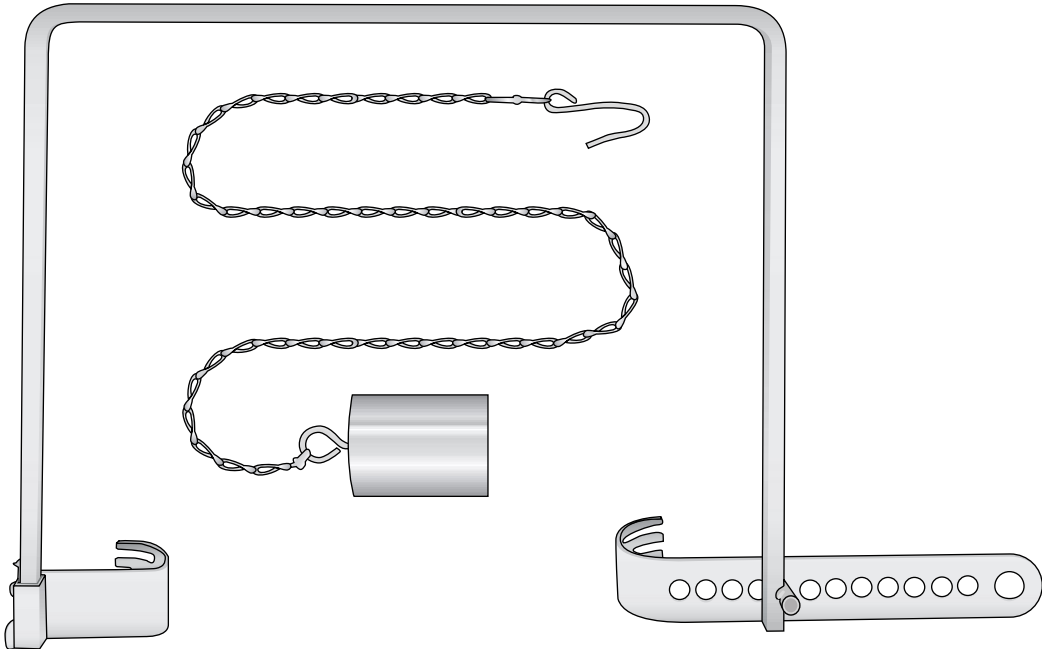

CHARNELY
AR 1150

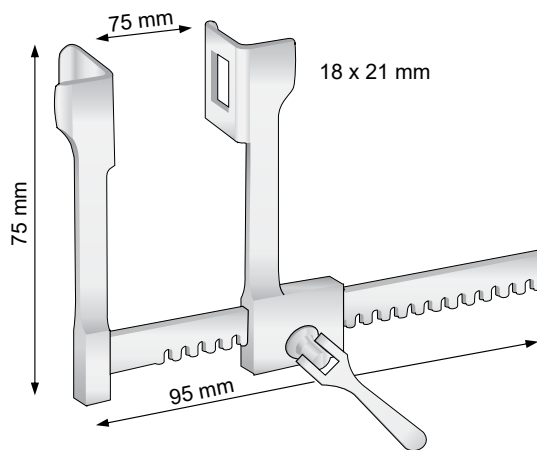
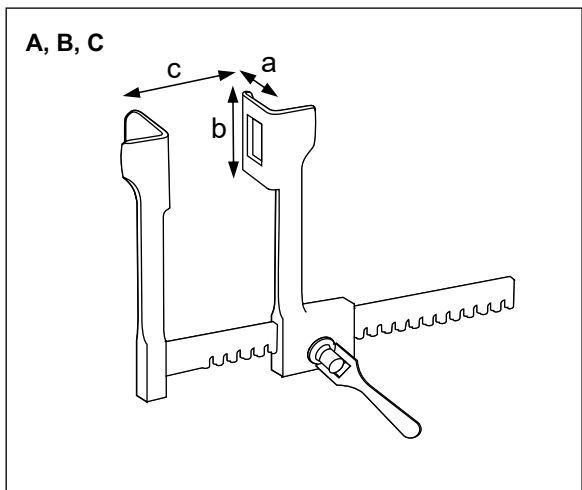

BABY FINOCCHIETTO
 a b c
R 1154 18 x 20 mm 75 mm

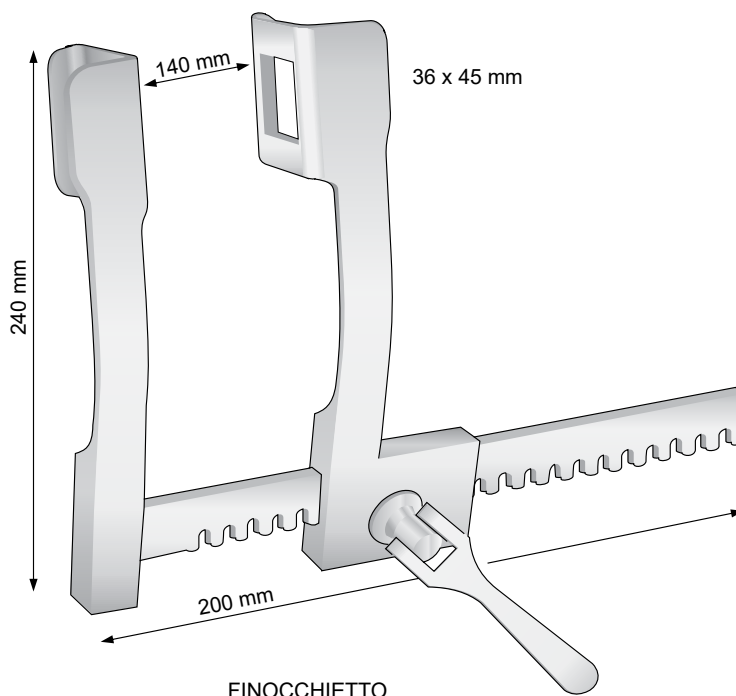

FINOCCHIETTO
 a b c
R 1155-01 40 x 40 mm 165 mm
R 1155-02 45 x 65 mm 200 mm
R 1155-03 70 x 65 mm 250 mm

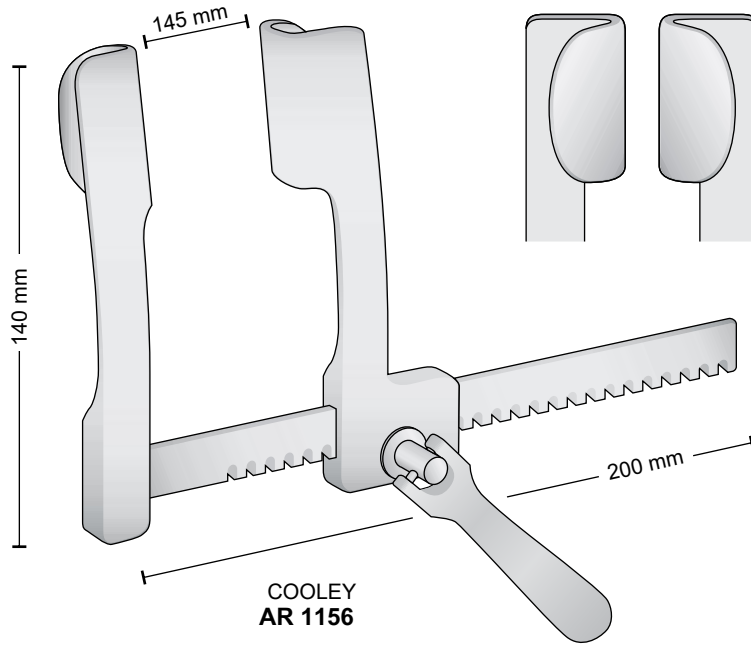

**COOLEY
AR 1156**

Valve
Blades
Blätter
Valves
Valvas
21 x 45 mm

Per bambini
For children
Für Kinder
Pour enfants
Para niños

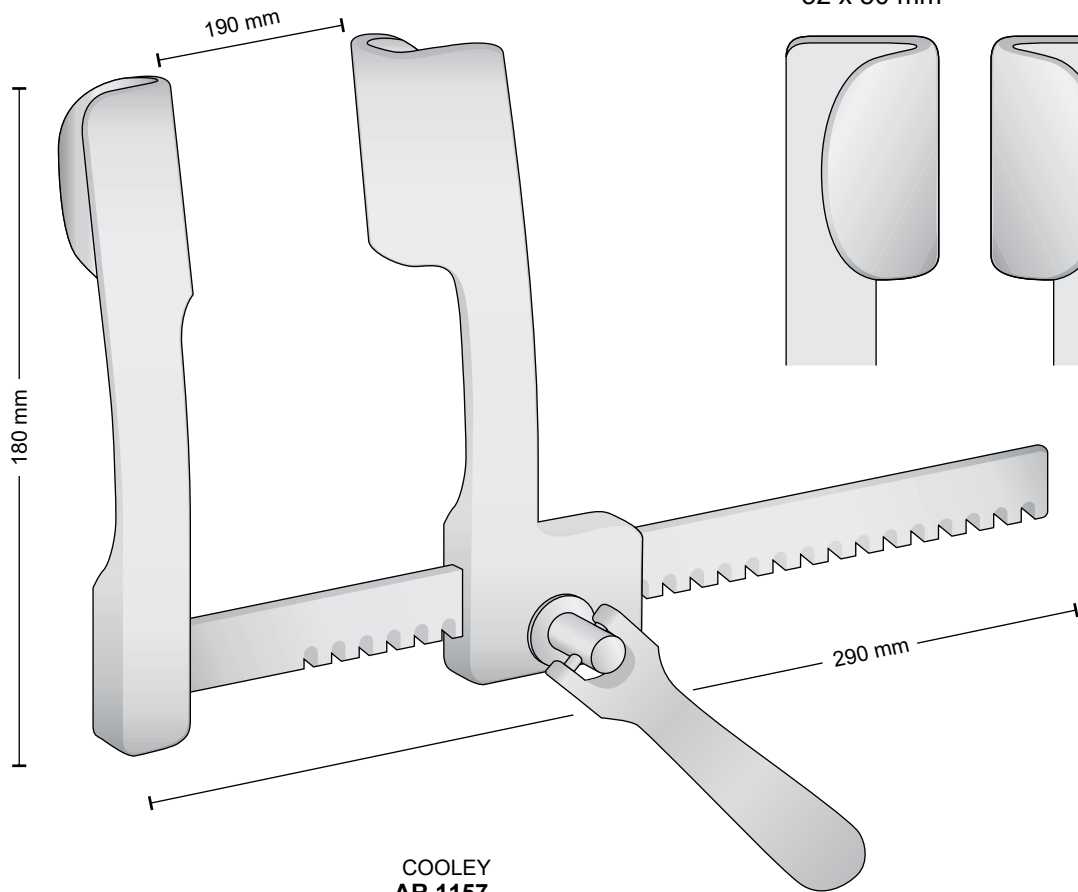

**COOLEY
AR 1157**

Valve
Blades
Blätter
Valves
Valvas
32 x 50 mm

Per adulti
For adults
Für Erwachsene
Pour adultes
Para adultos

Valve - Blade - Blätter

Valve - Valvas

50 x 43 mm

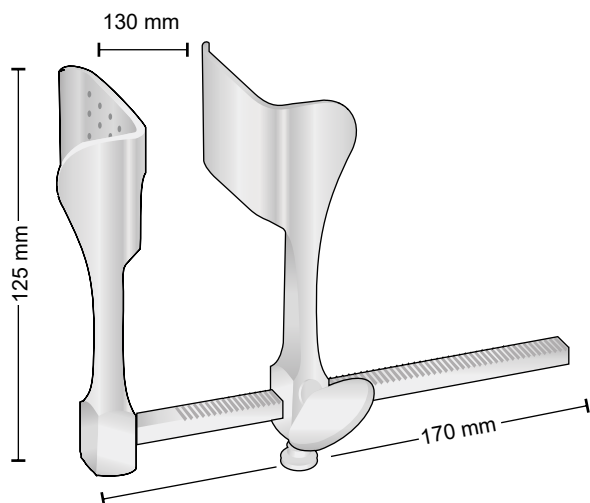

**TUFFIER
 AR 1158**

Divaricatori per sternotomia

Sternotomy spreaders

Sternotomie-Sperrer

Ecarteurs à sternotomie

Separador para sternotomia

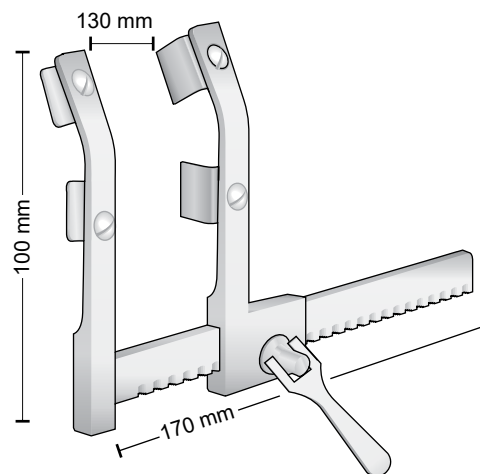

**BABY-MORSE
 AR 1159**

Divaricatori per sternotomia - Sternotomy spreaders - Sternotomie-Sperrer

Ecarteurs à sternotomie - Separador para sternotomia

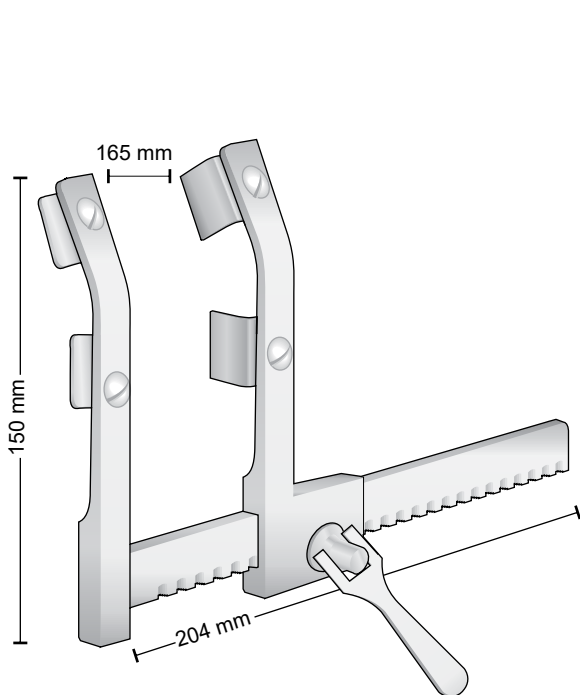

**MORSE
 AR 1160**

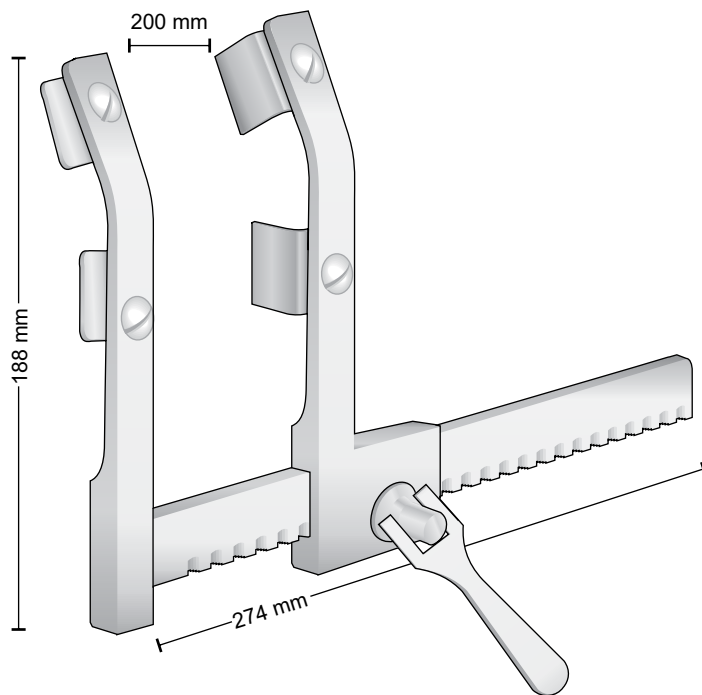

**MORSE
 AR 1161**

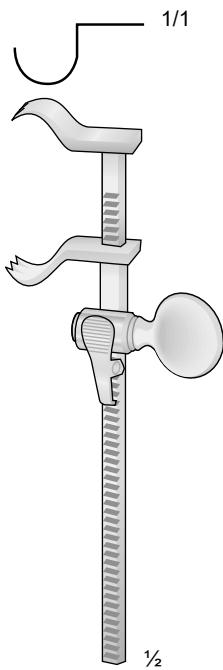

BAILEY
AR 1163-16 16 cm

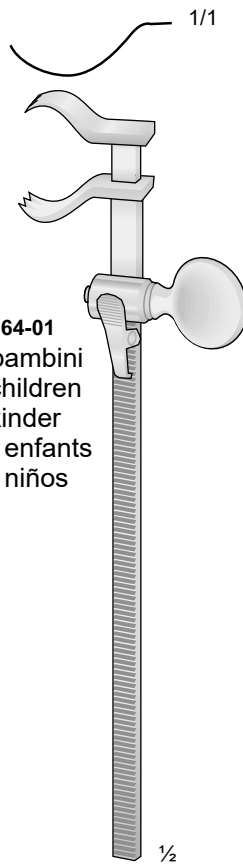

AR 1164-01
Per bambini
For children
Für kinder
Pour enfants
Para niños

BAILEY
AR 1164-01 / AR 1164-02
20 cm

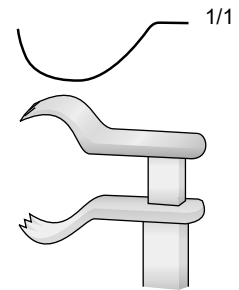

AR 1164-02
Per adulti
For adults
Für Erwachsene
Pour adultes
Para adultos

Valva centrale
 Center blade
 Mittelblatt
 Valve centrale
 Valva central

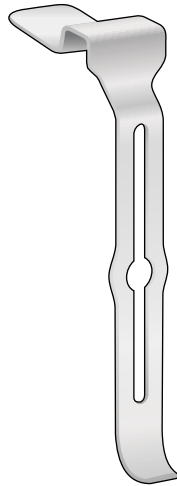

AR 1165

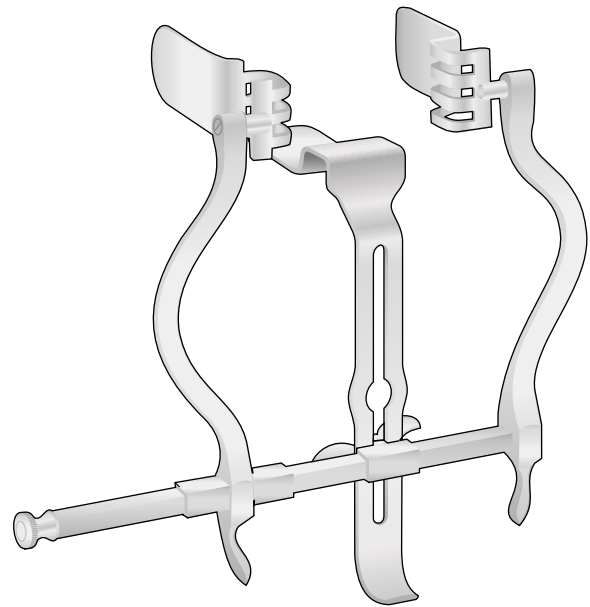

**JUDD-MASSON
 AR 1166**

Speculum rettale
 Rectal specula
 Mastdarm rektum spekulum
 Spéculum pour rectum
 Espéculus rectales

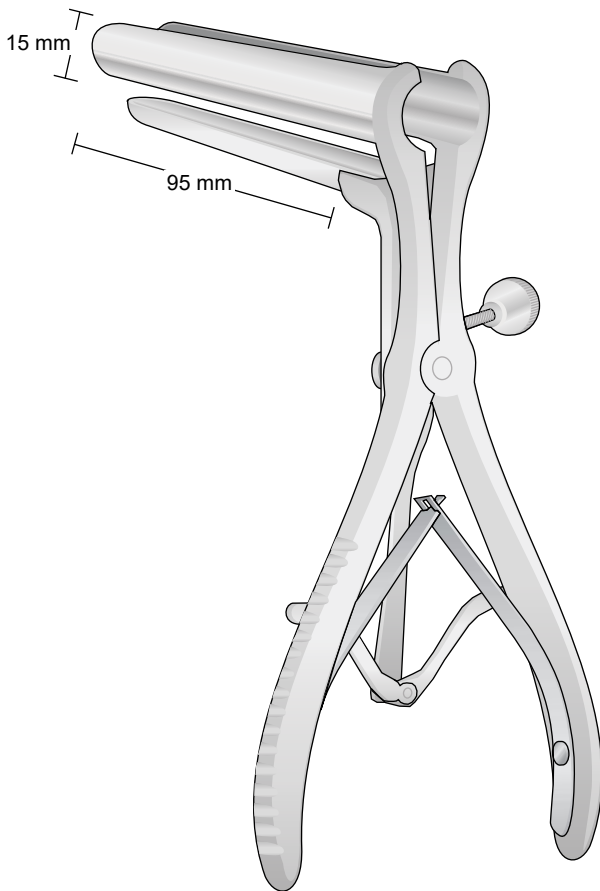

**MATHIEU
 AR 1171-21 21.5 cm**

AR 1167
 Divaricatore solo - Retractor only
 Sperrer allein - Ecarteur seul
 Separador suelto

AR 1168
 Valva laterale
 Lateral blade
 Seitliche Blätter
 Valves latérales
 Valva laterales
 80 x 25 mm

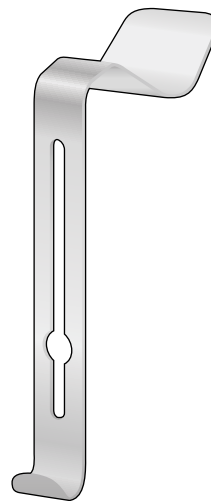
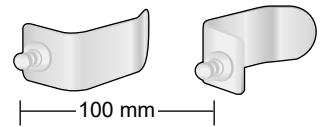

AR 1169

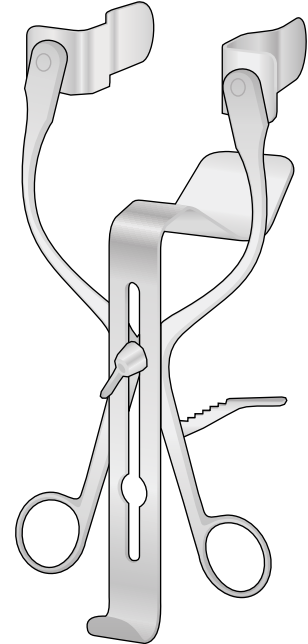

**MILLIN
 AR 1170**

Valva centrale - Center blade - Mittelblatt
 Valve centrale - Valva central

Completo - Complete - Komplett
 Complet - Completo

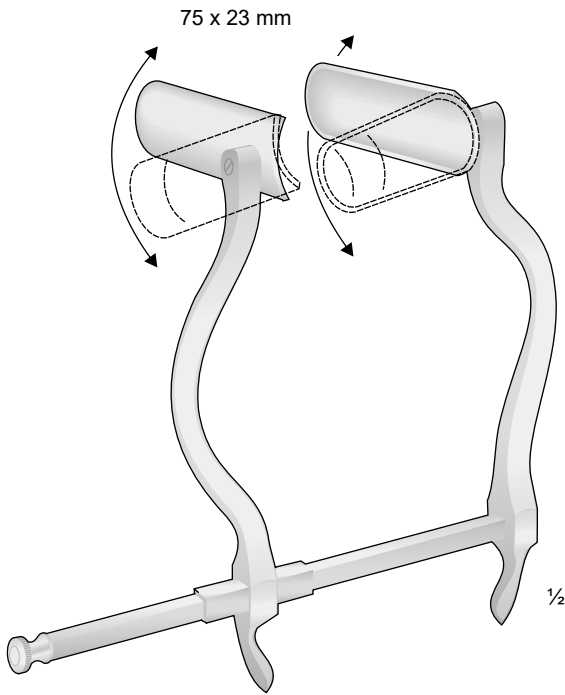

SMITH-BUIE
AR 1171-15 15 cm

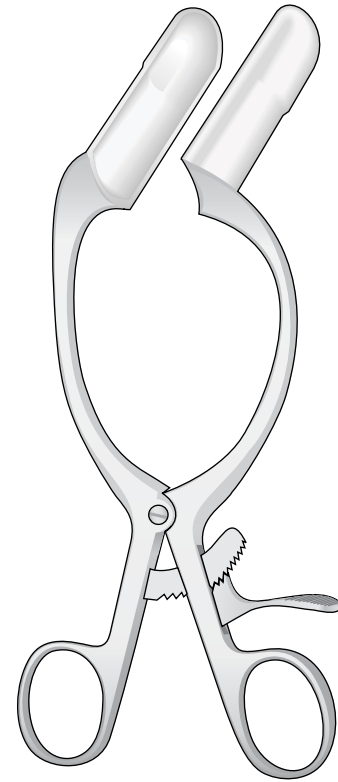

BARR
AR 1172-17 17 cm

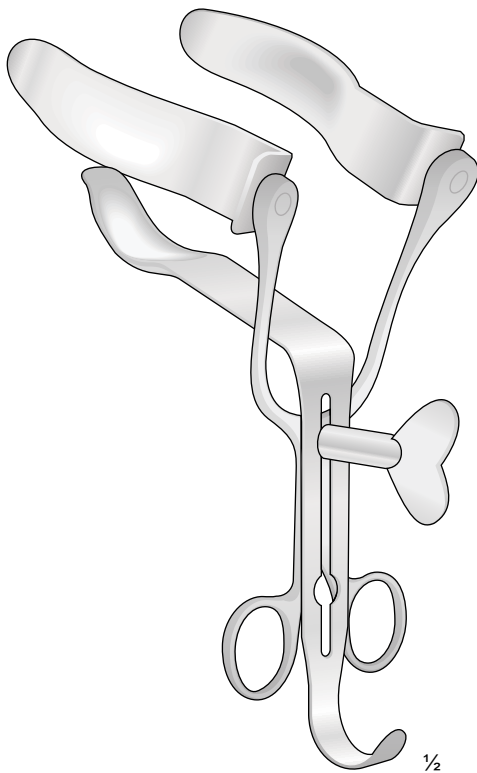

ALAN PARKS
AR 1173-13 13.5cm

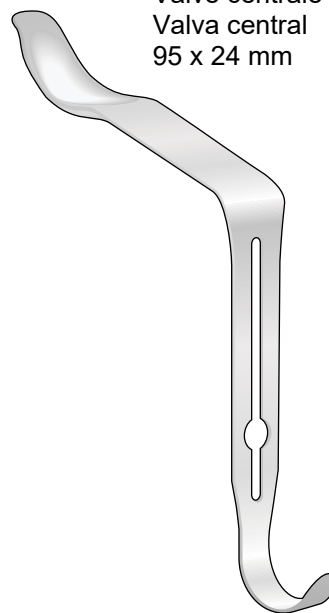

Valva centrale
Center blade
Mittelblatt
Valve centrale
Valva central
95 x 24 mm

AR 1176

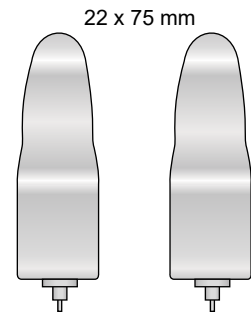

AR 1174

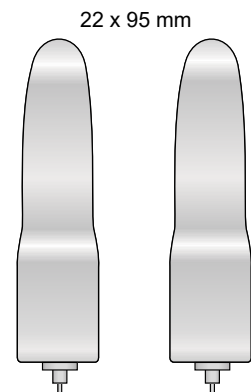

AR 1175

Trocar⁺ Biopsy Needles



we take a closer look

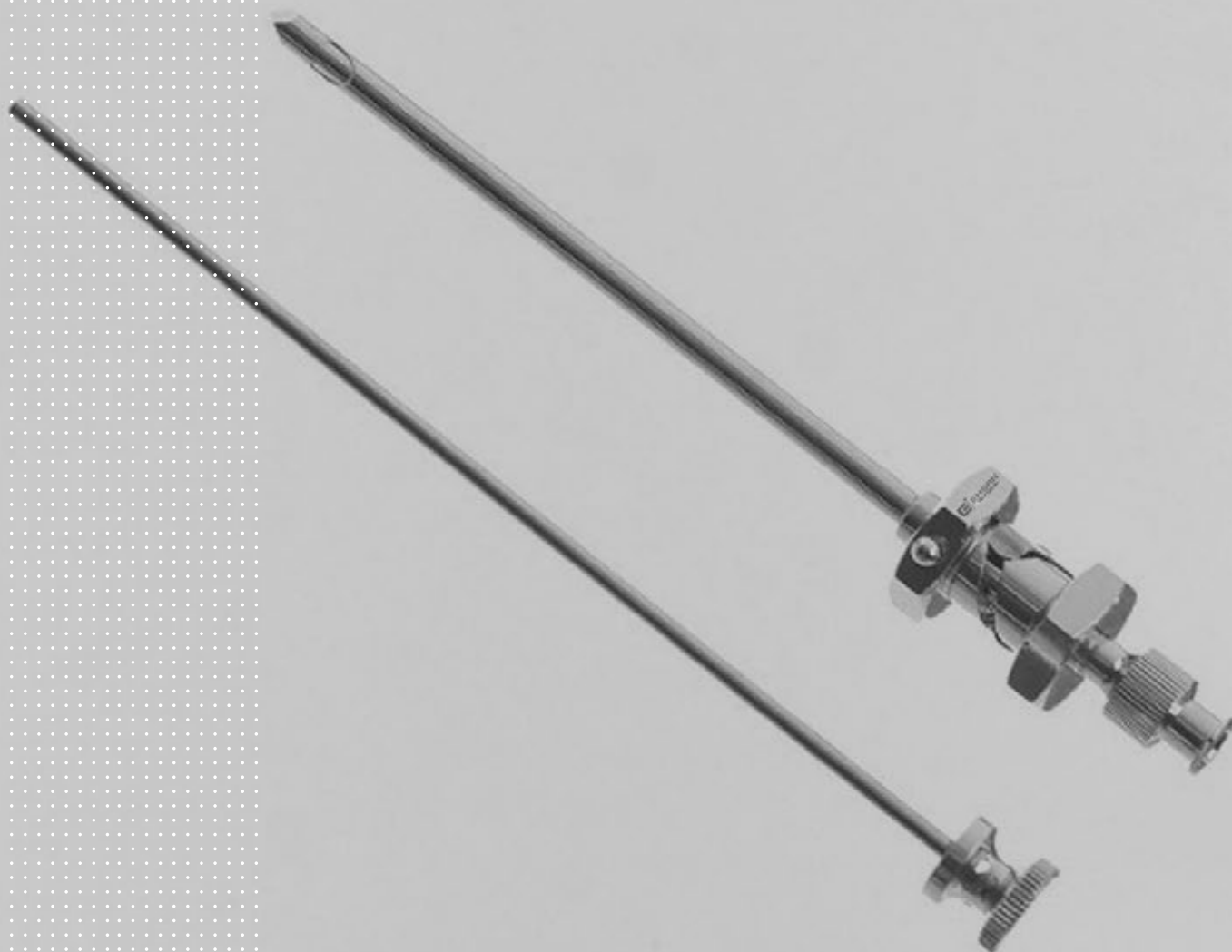

Trokar | Biopsienadeln
Trocart | Aiguilles pour biopsie
Trocar | Aguja para biopsia
Trocar | Aghi da biopsia

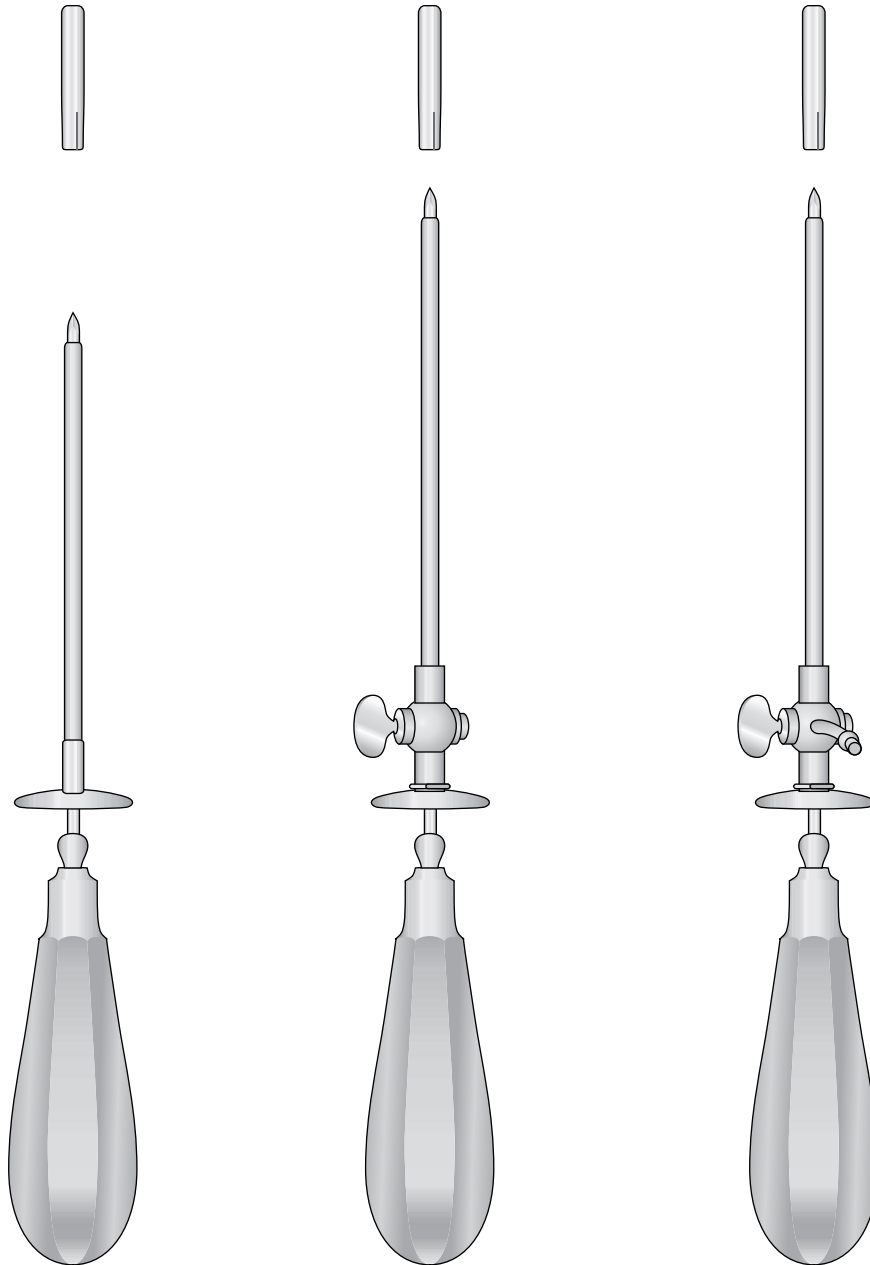

Ø mm
Esterno
Outside
Außen
Extérieur
Exterior

Ø mm
Interno
Inside
Innen
Intérieur
Interior

		STANDARD	STANDARD	STANDARD
3,0	2,0	T 1180-01	T 1181-01	T 1182-01
3,5	2,5	T 1180-02	T 1181-02	T 1182-02
4,0	3,0	T 1180-03	T 1181-03	T 1182-03
4,5	3,5	T 1180-04	T 1181-04	T 1182-04
5,0	4,0	T 1180-05	T 1181-05	T 1182-05
5,5	4,5	T 1180-06	T 1181-06	T 1182-06
6,0	5,0	T 1180-07	T 1181-07	T 1182-07
		110 mm	120 mm	120 mm

Per vescica biliare - For gall bladder - Für die gallenblase
Pour la vésicule biliaire - Para vesícula biliar

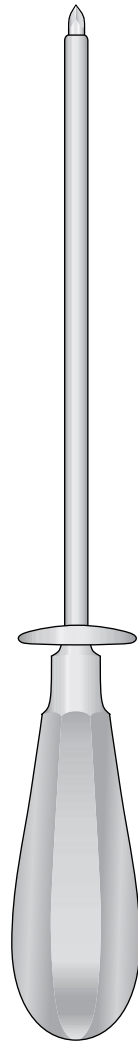
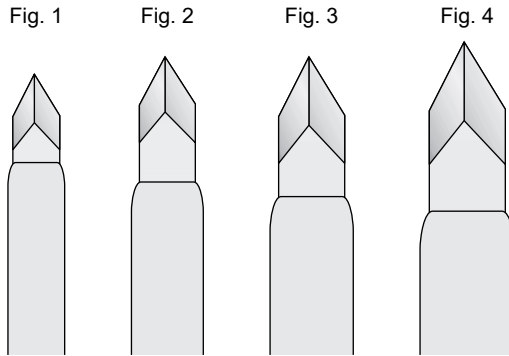

Ø mm Esterno Outside Außen Extérieur Exterior	Ø mm Interno Inside Innen Intérieur Interior		
7,5	6,0	Fig. 1	T 1183-01
9,5	8,0	Fig. 2	T 1183-02
11,0	9,5	Fig. 3	T 1183-03
12,5	11,0	Fig. 4	T 1183-04

210 mm

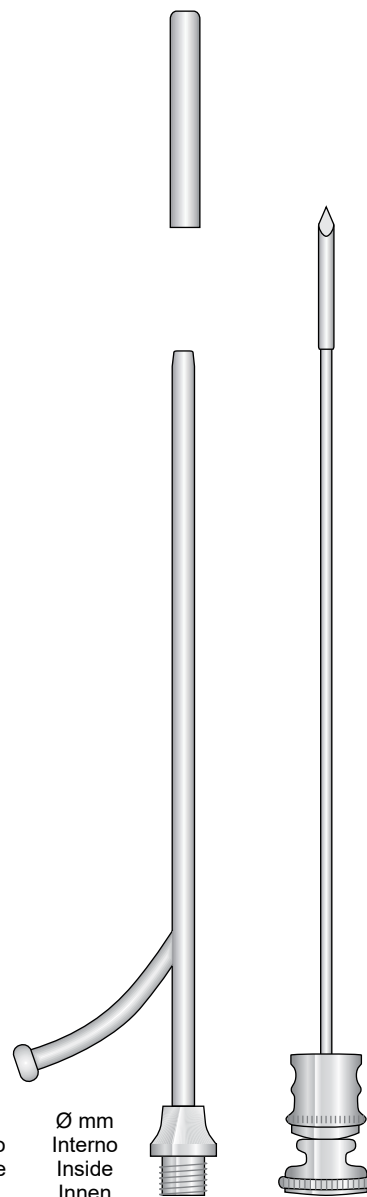

Ø mm Esterno Outside Außen Extérieur Exterior	Ø mm Interno Inside Innen Intérieur Interior		
4,0	3,0		T 1184-01
4,6	3,6		T 1184-02
5,3	4,3		T 1184-03
6,0	5,0		T 1184-04

210 mm

Trequarti per seno mascellare
Antrum puncture trocars
Kieferhöhlentrokare
Trocarts pour sinus maxillaire
Trócares para punción del seno maxilar

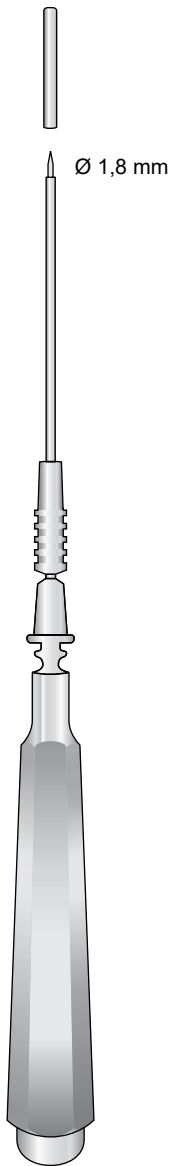

LICHTWITZ
T 1185-19 19 cm

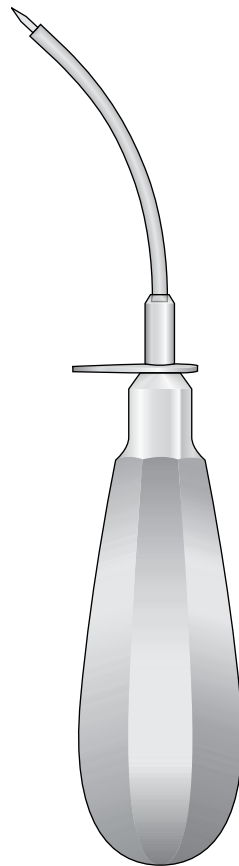
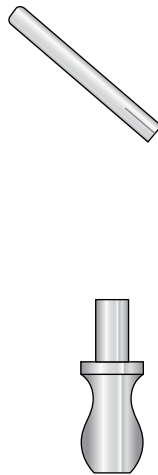

PIERCE 160 mm
Code Size
T 1186-03 Ø 3 mm
T 1186-04 Ø 4 mm
T 1186-05 Ø 5 mm

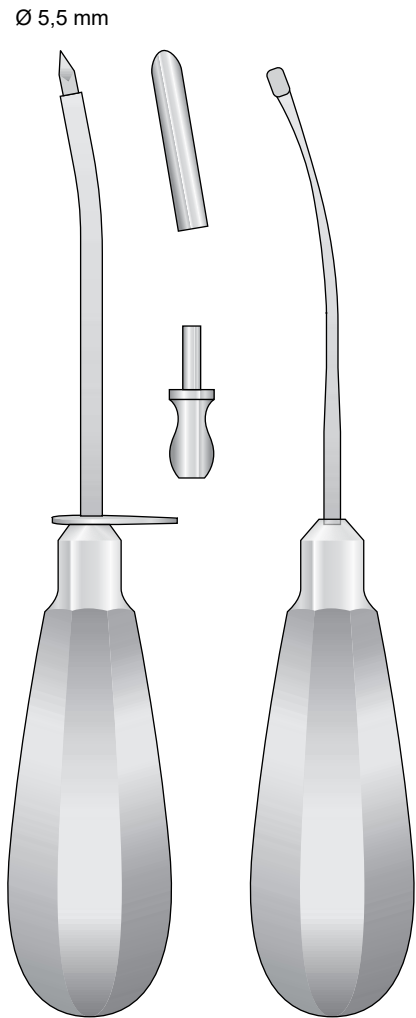

Set completo Krause
Krause set complete
Krause Komplettsset
Set complet Krause
Set completo Krause

KRAUSE
T 1187-16 16 cm

Universale completo con 3 punte
Set of 3 pieces
Satz zu 3 stück
Jeu de 3 pièces
Juego de 3 piezas

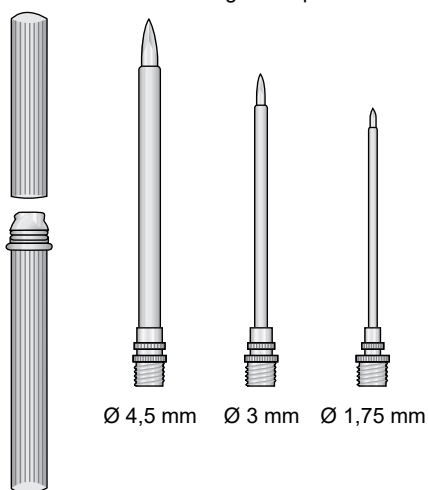

UNIVERSAL
T 1188 Set of 3 pieces

Universale completo con 4 punte
Set of 4 pieces
Satz zu 4 stück
Jeu de 4 pièces
Juego de 4 piezas

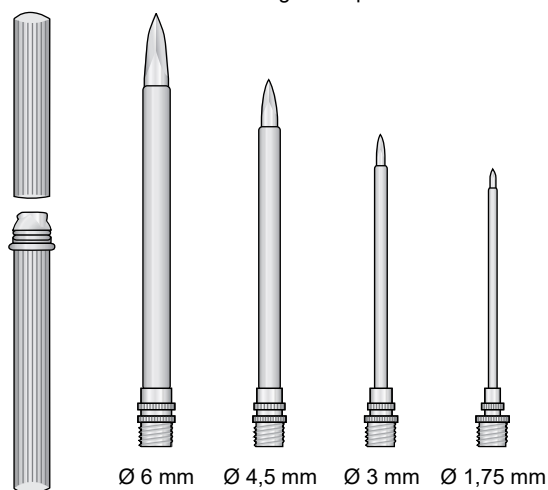

UNIVERSAL
T 1189 Set of 4 pieces

Universale completo con 3 punte
Set of 3 pieces
Satz zu 3 stück
Jeu de 3 pièces
Juego de 3 piezas

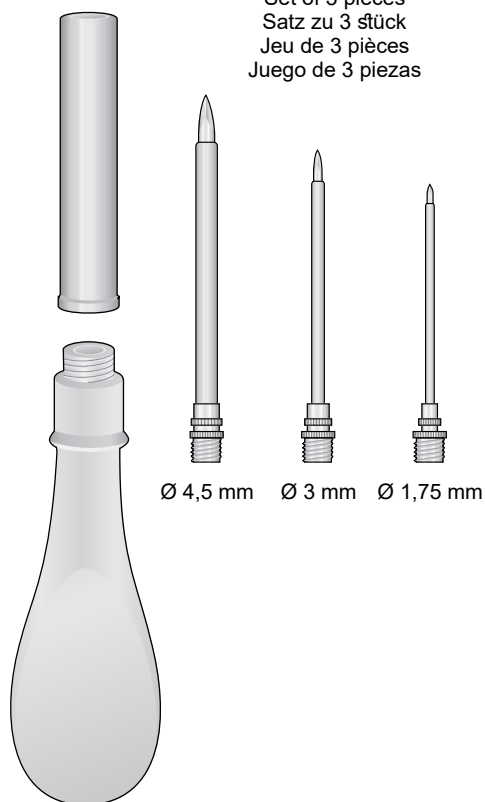

T 1190-13 13 cm

Universale completo con 4 punte
Set of 4 pieces
Satz zu 4 stück
Jeu de 4 pièces
Juego de 4 piezas

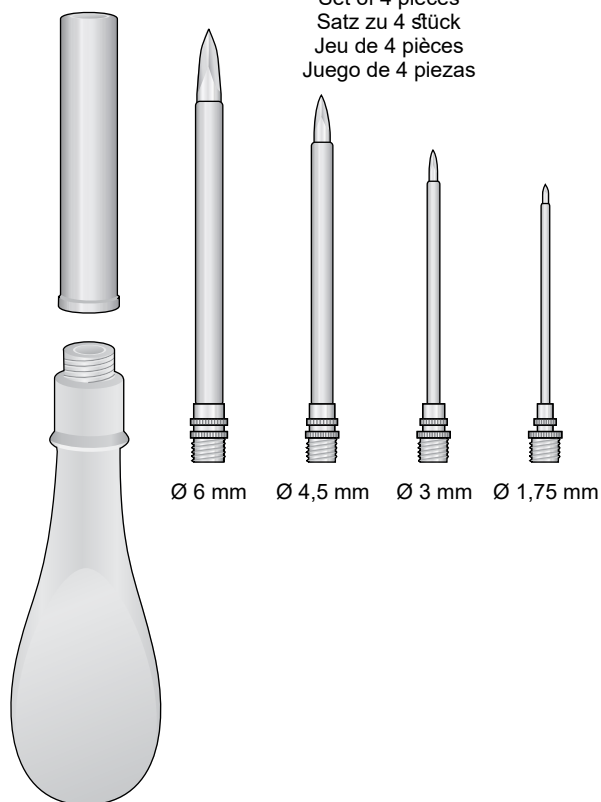

T 1191-13 13 cm

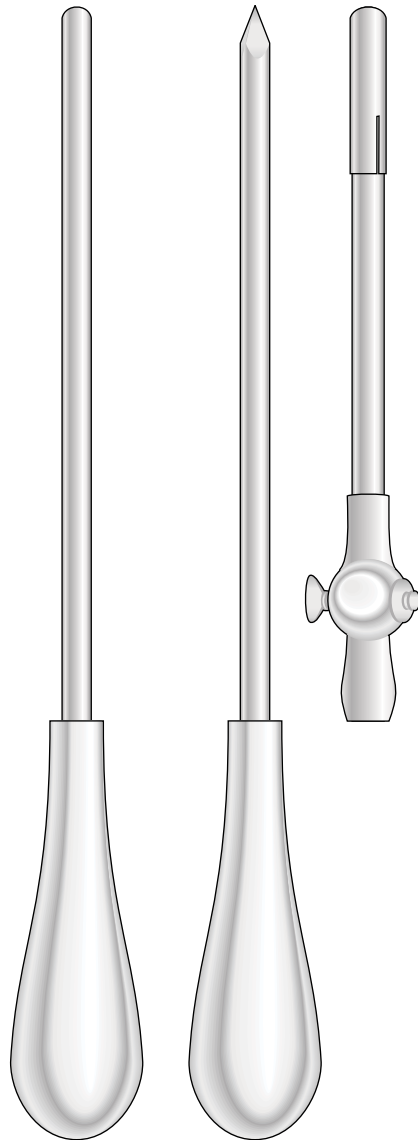

Ø mm	Ø mm
Esterno	Interno
Outside	Inside
Außen	Innen
Extérieur	Intérieur
Exterior	Interior

		BUELAU
8	6,5	T 1192-01
10	8,5	T 1192-02

240 mm

Ago per la puntura dello sterno
Sternal puncture needle
Sternal-punktionskänülen
Aiguilles pour la ponction sternale
Agujas para punción esternal

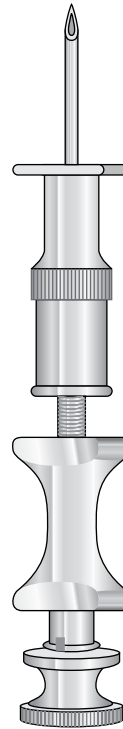

KLIMA-ROSEGGER
T 1193
1,80 x 35 mm

DUKE
T 1194
110 mm - 5,5 mm

Trequarti
Trocars
Trokare
Trocarts
Tròcares

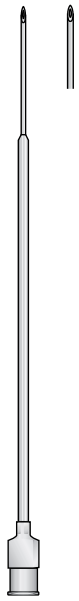

T 1195-12 12 cm

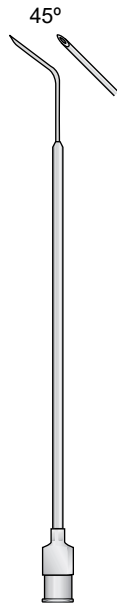

T 1196-11 11 cm

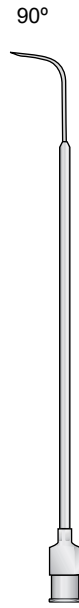

T 1197-11 11 cm

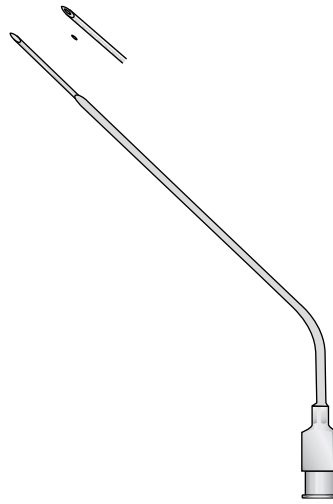

T 1198-11 11 cm

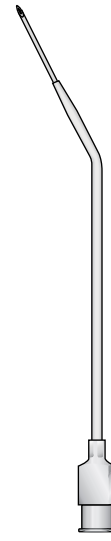

T 1199-11 11 cm

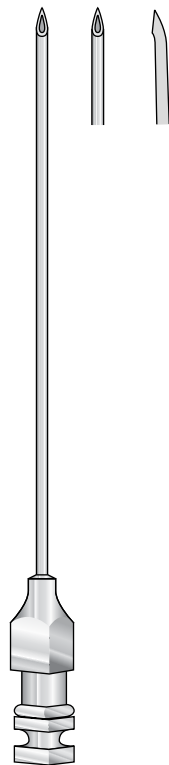

TUOHY

Code	Size
T 1200-13	1,30 x 80 mm
T 1200-15	1,50 x 80 mm
T 1200-16	1,65 x 80 mm



QUINCKE

Code	Size
T 1201-01	0,70 x 80 mm
T 1201-02	0,70 x 90 mm
T 1201-03	1,00 x 80 mm
T 1201-04	1,00 x 90 mm
T 1201-05	1,20 x 90 mm
T 1201-06	1,20 x 100 mm



we take a closer look



Elevators, Periosteal Bone files, Curettes

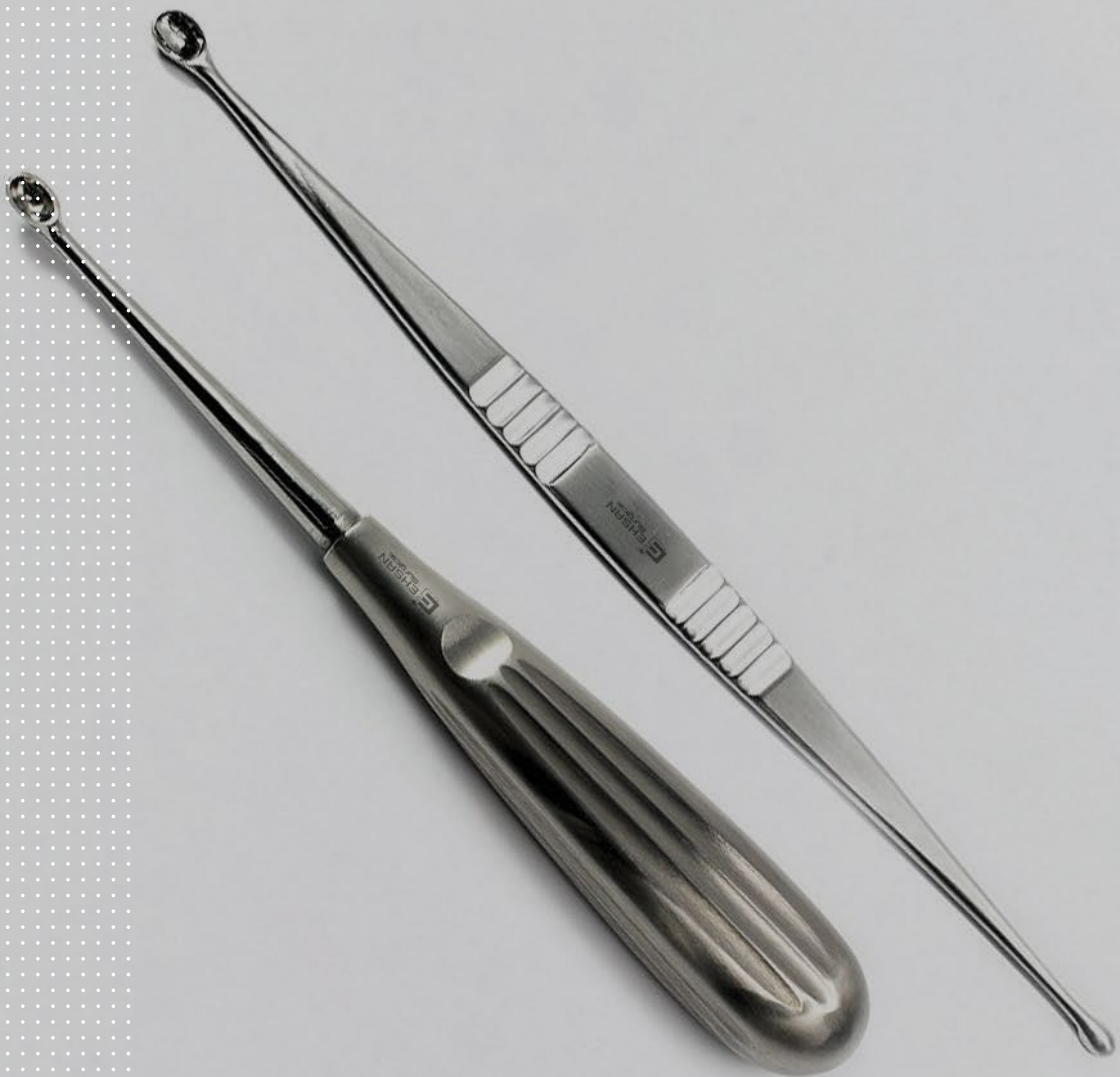

| Elevatoren | Raspatorien | Knochenfeilen | Küretten
| Élévateurs | Rugines périostiques | Limes à os | Curettes
| Elevadores | Periostótomos | Limas para hueso | Curetas
| Elevatori | Scollaperiosteo | Lime per osso | Curettes

6 mm



8 mm

E 1205-13 13.5 cm

8 mm



10 mm

E 1206-13 13.5 cm

4,5 mm

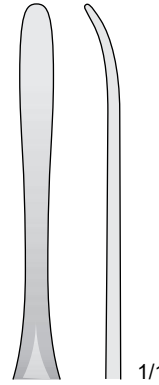

1/1

KÖNIG

E 1207-15 15.5 cm

4,5 mm

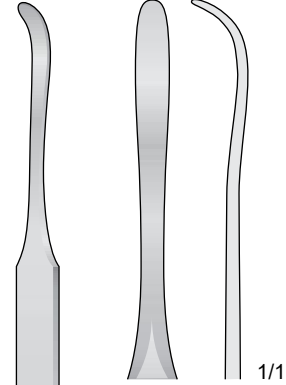

1/1

KÖNIG

E 1208-15 15.5 cm

5 mm

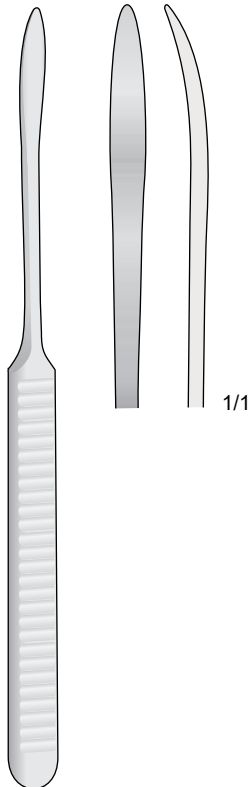

1/1

WILLIGER

E 1209-16 16.5 cm

6 mm

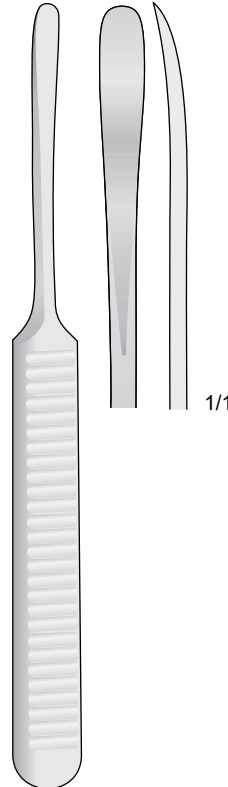

1/1

WILLIGER

E 1210-16 16 cm

4 mm

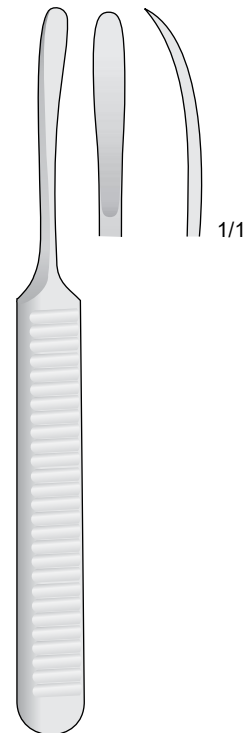

1/1

Periostotomi
Periosteal Raspatories
Raspatorien
Rugines à périostomie
Legras periostotomos

WILLIGER

E 1211-14 14 cm

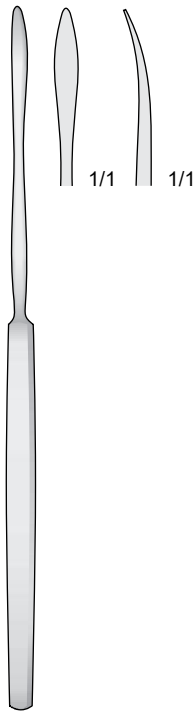

DS 1212-17 17.5 cm

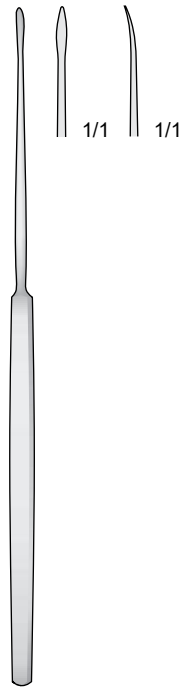

DS 1213-16 16 cm

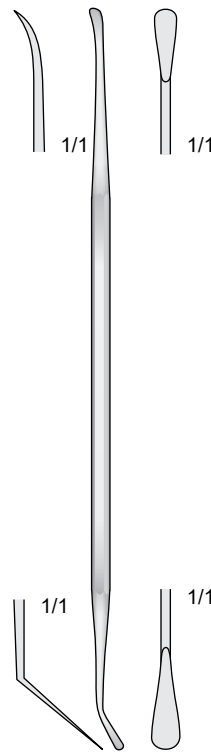

MILLIGAN
DS 1214-21 21 cm

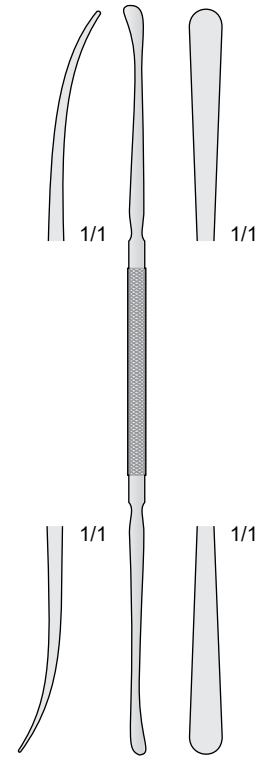

DAVIS
DS 1215-24 24.5 cm

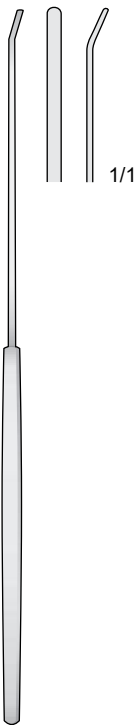

FAGER
DS 1216-20 20 cm

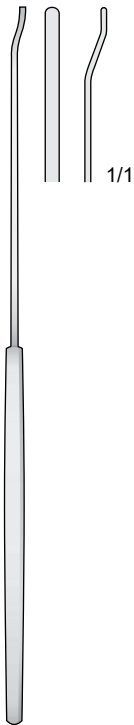

FAGER
DS 1217-20 20 cm

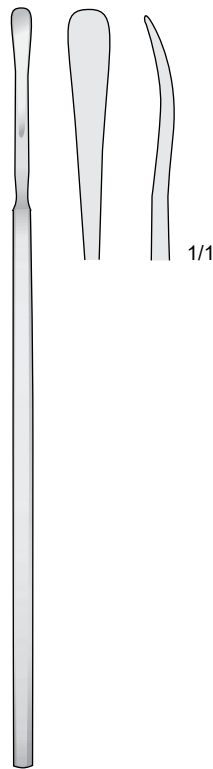

SACHS
DS 1218-21 21 cm

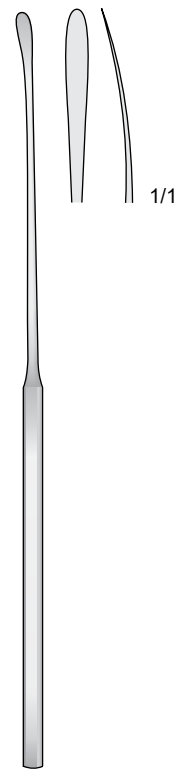

SACHS
DS 1219-21 21 cm

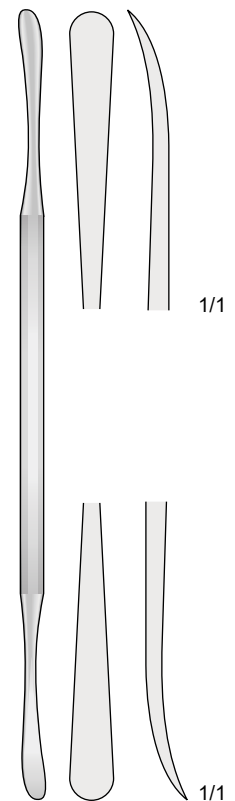

DS 1220-22 22 cm

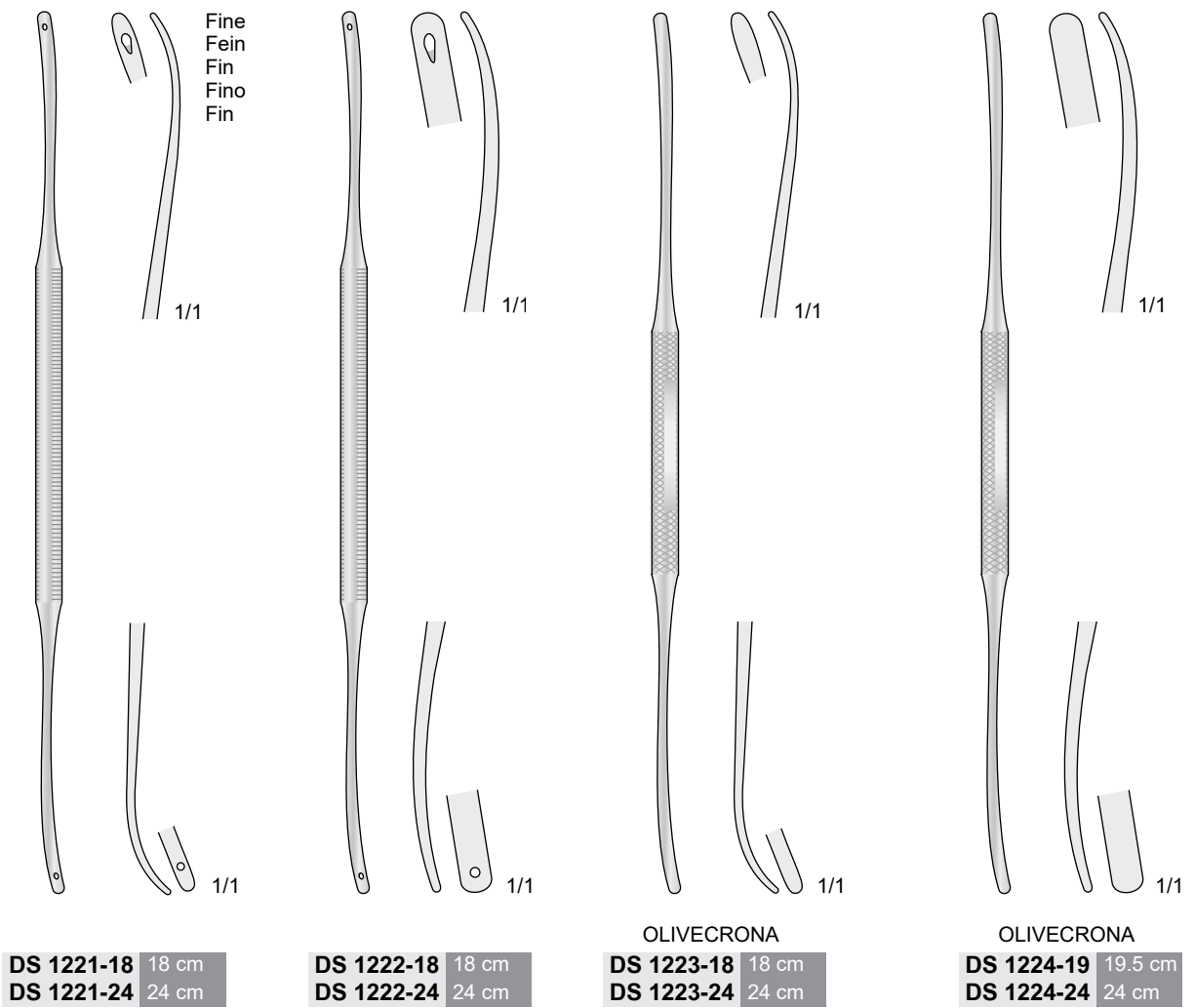

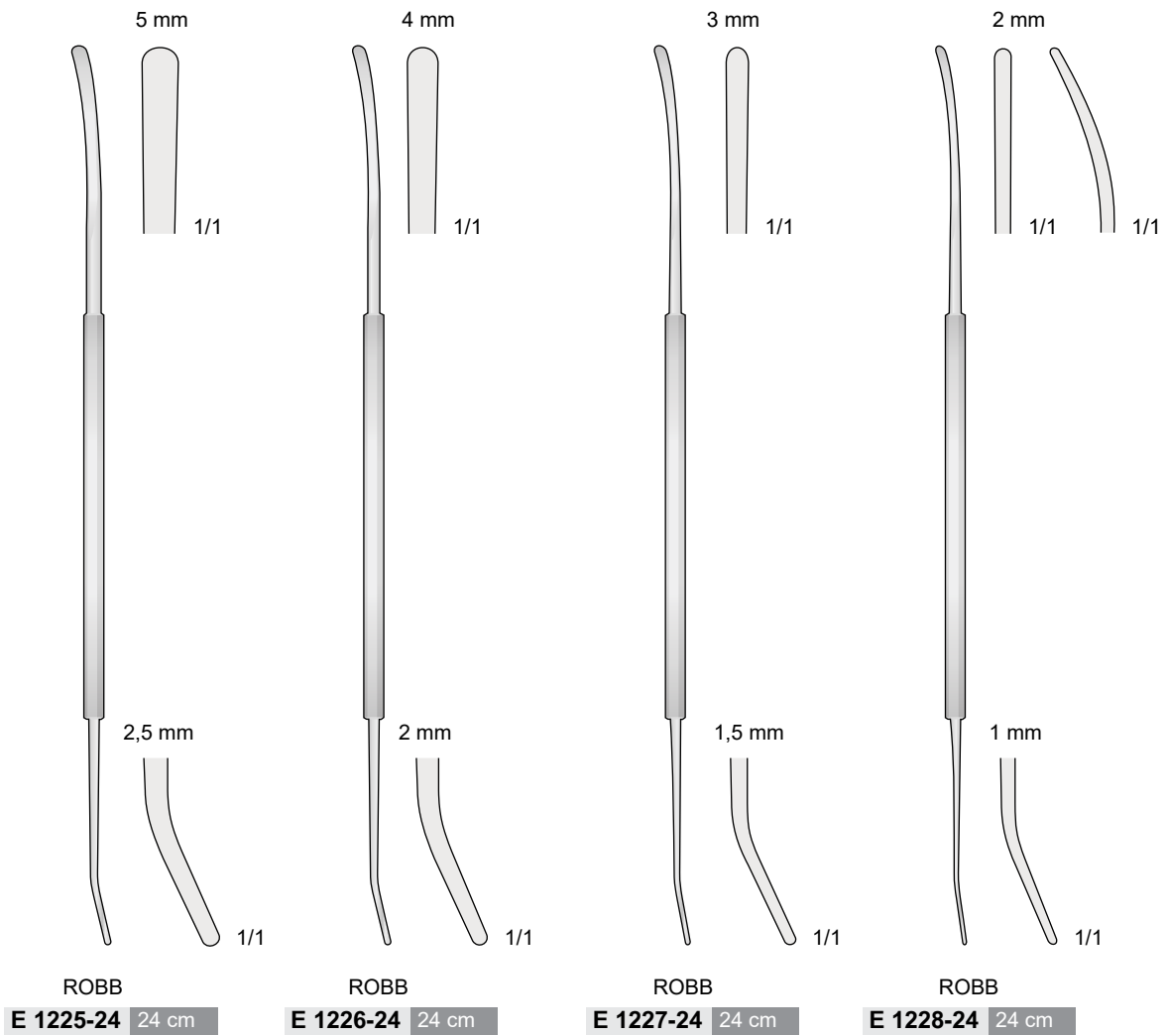

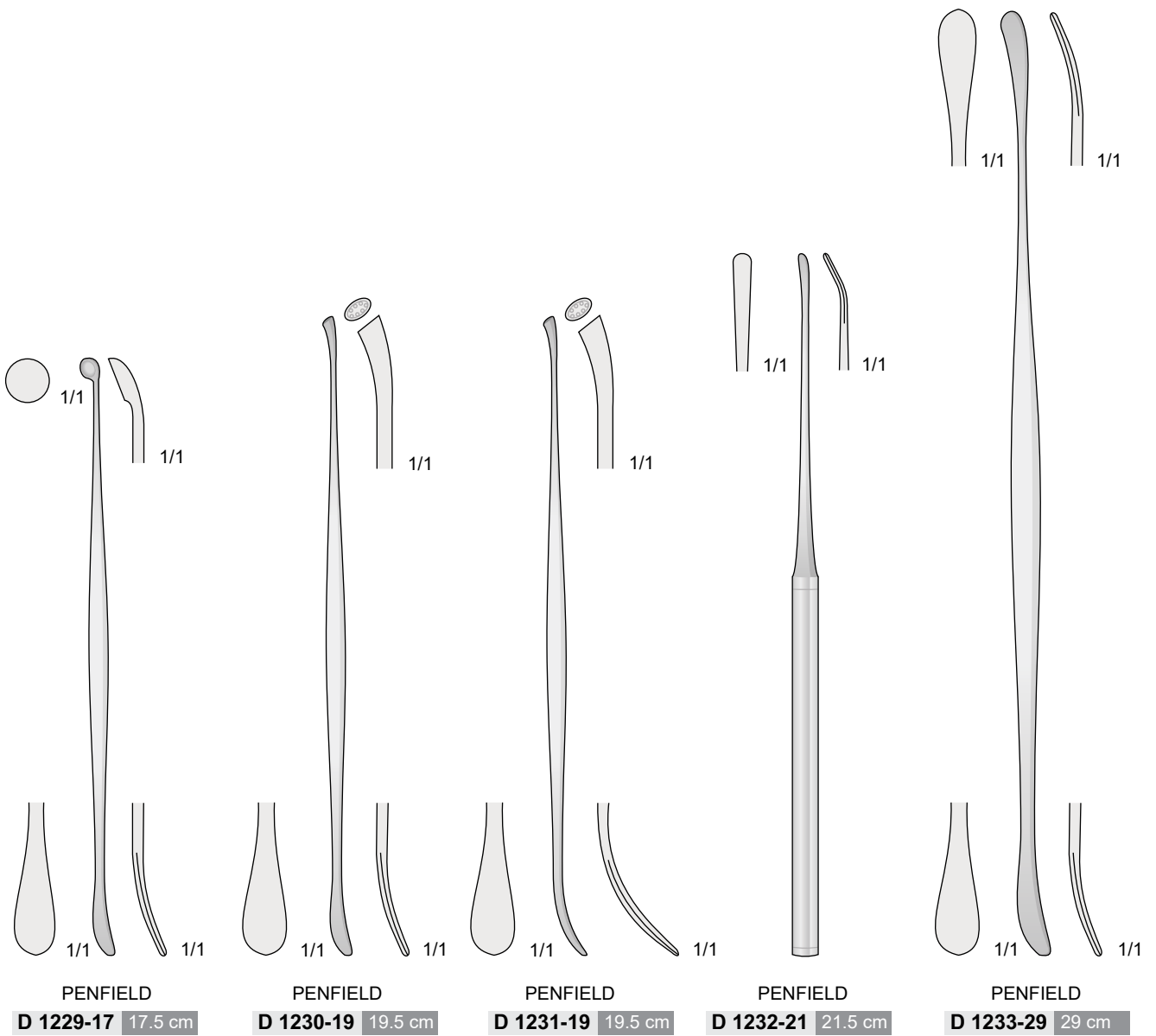

Nerve protectors

Destro
Right
Rechts
À droite
A la derecha

Sinistro
Left
Links
À gauche
A la izquierda

0°

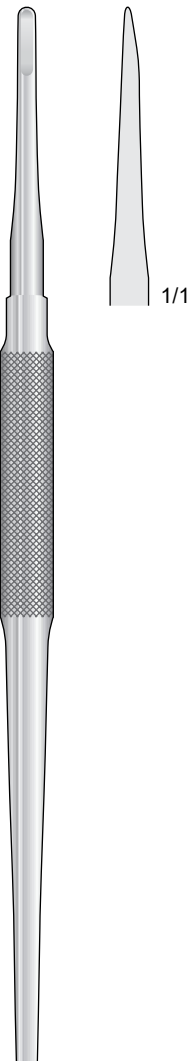

R 1234-16 16.5 cm

22,5°

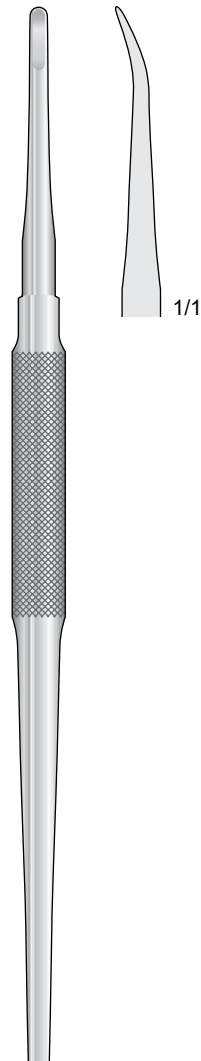

R 1235-16 16.5 cm

45°

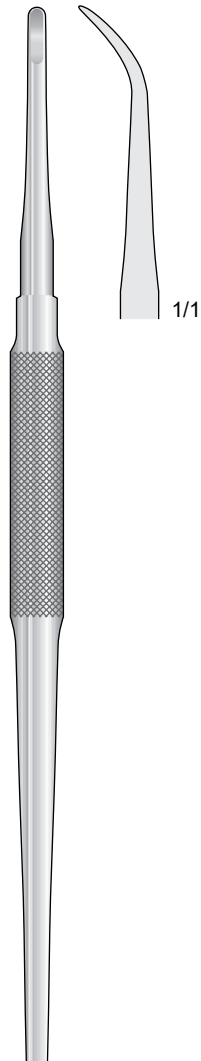

R 1236-16 16.5 cm

22,5°

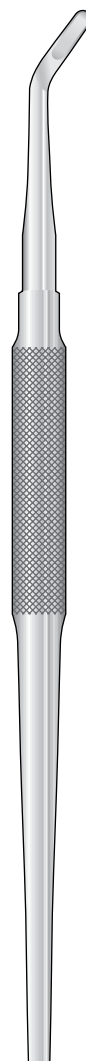

R 1237-16 16.5 cm

22,5°

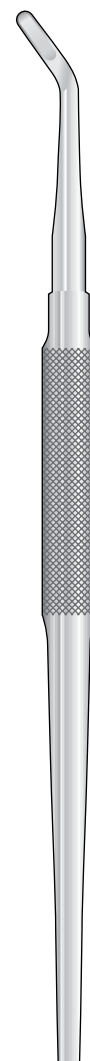

R 1238-16 16.5 cm

Periostotomi
 Raspatories
 Raspatorien
 Rugines
 Legras

Elevatori orbitali

Sinistro	Destro
Left	Right
Links	Rechts
À gauche	À droite
A la izquierda	A la derecha
5 mm	5 mm

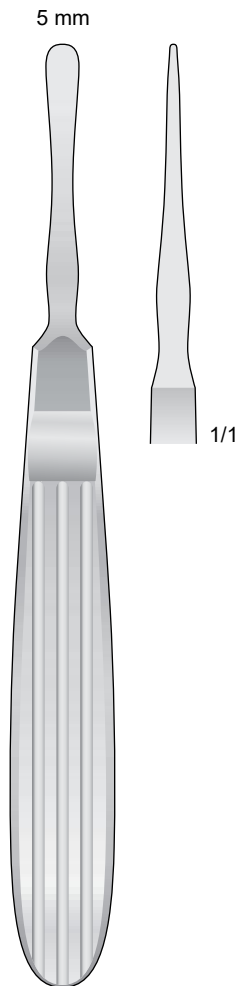

R 1239-14 14.5 cm

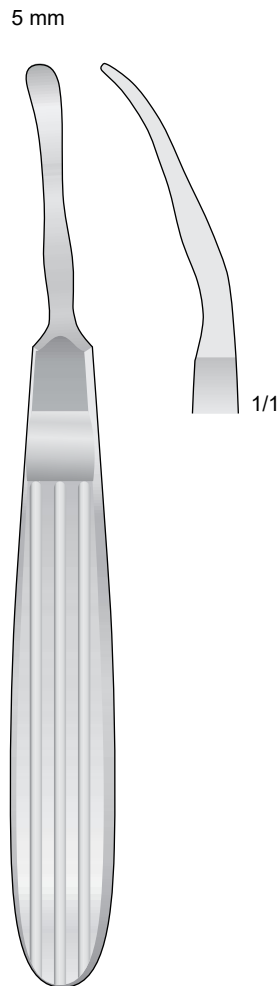

R 1240-14 14 cm

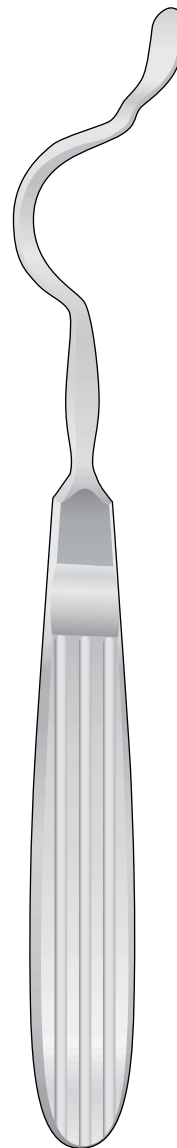

R 1241-16 16 cm

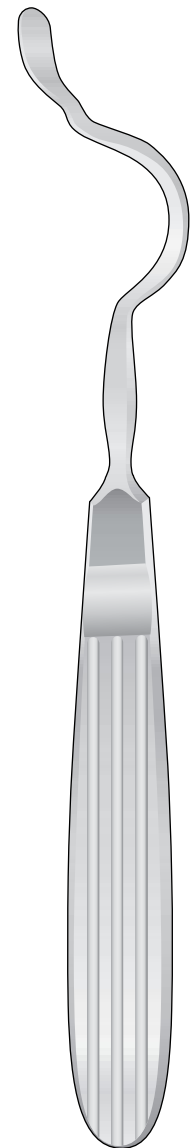

R 1242-16 16 cm

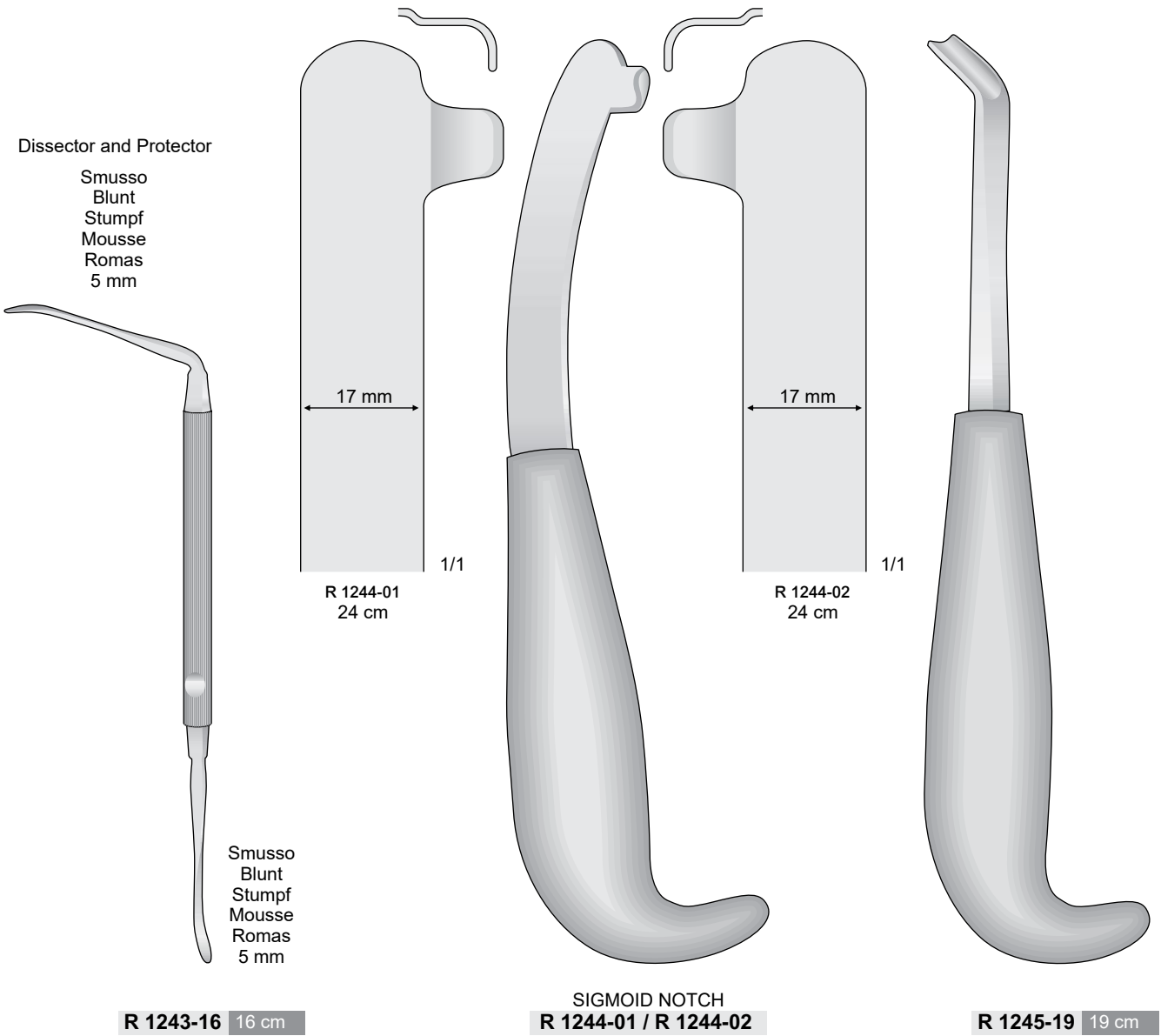

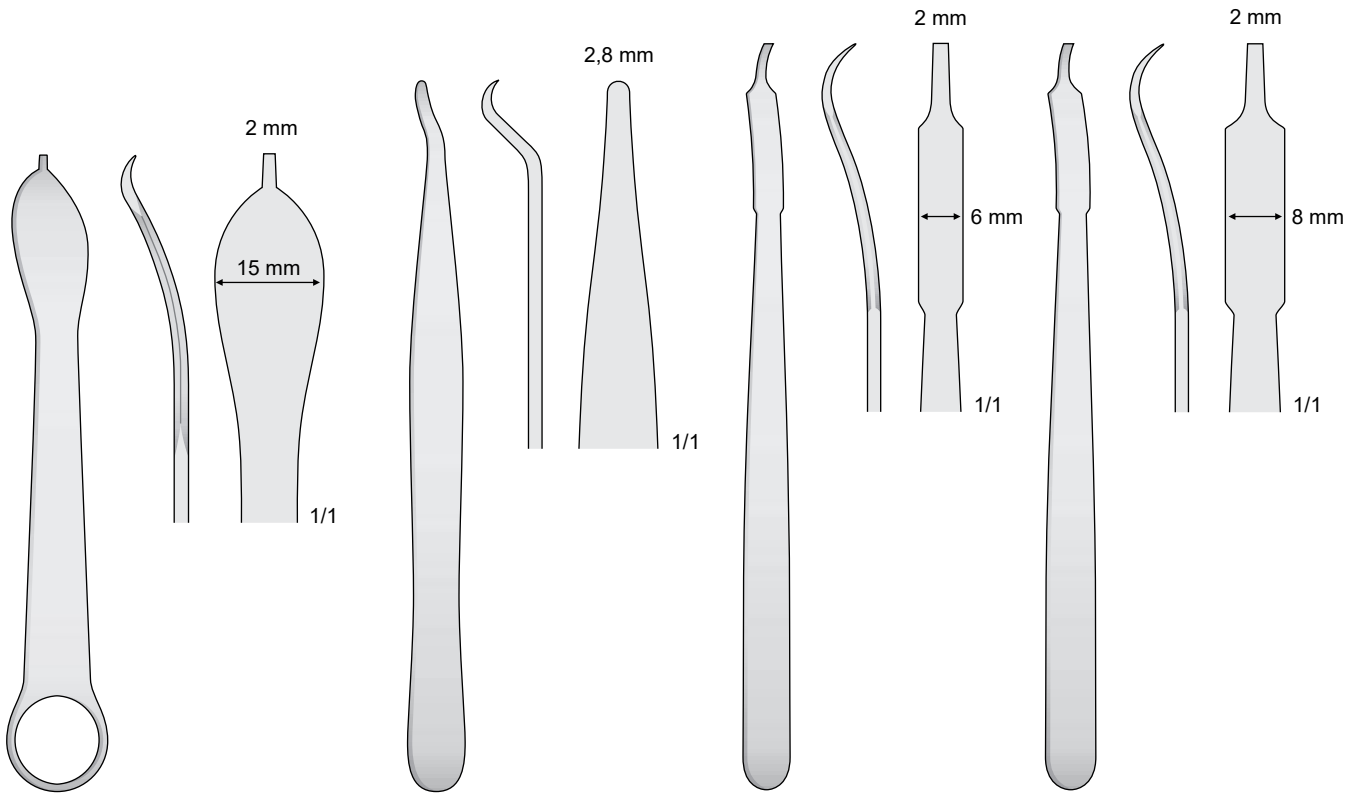

E 1246-12 12 cm

E 1247-14 14 cm

MINI-HOHMANN
E 1248-16 16 cm

MINI-HOHMANN
E 1249-16 16 cm

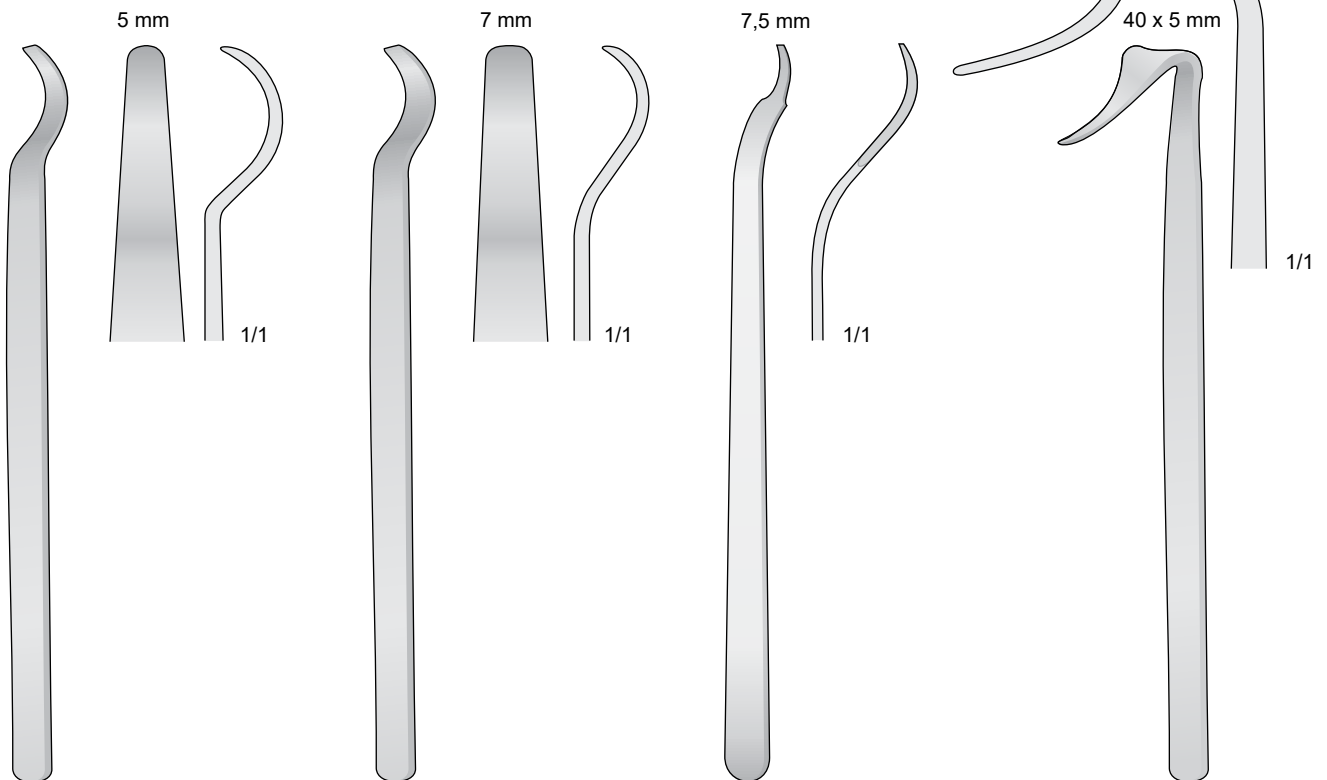

E 1250-15 15 cm

E 1251-15 15 cm

BUCK-GRAMCKO
E 1252-15 15 cm

BLOUNT
E 1253-17 17.5 cm

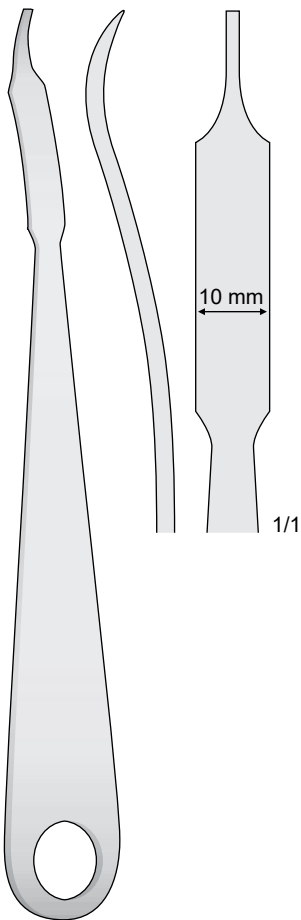

E 1254-22 22 cm

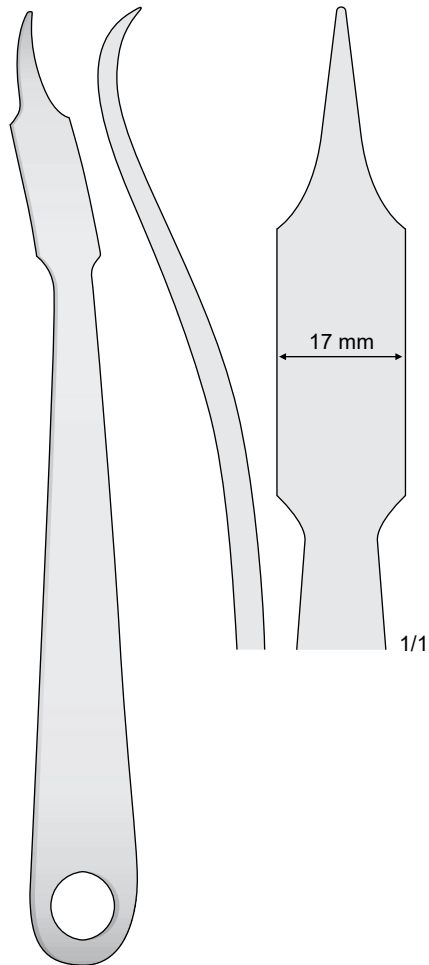

E 1255-24 24 cm

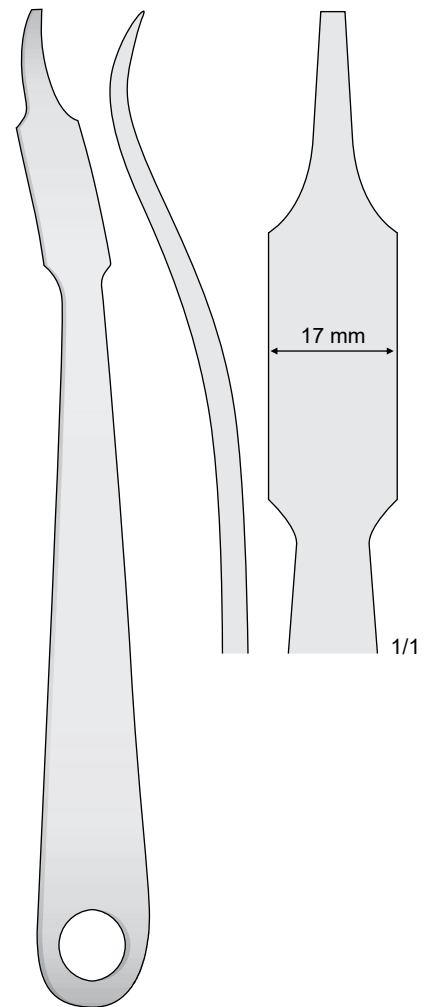

E 1256-24 24 cm

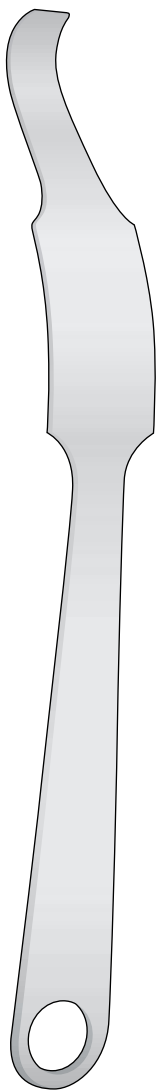

HOHMANN
E 1257-01 / E 1257-02

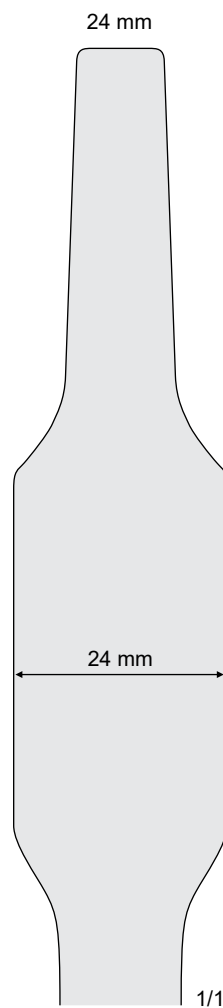

E 1257-01
26 cm

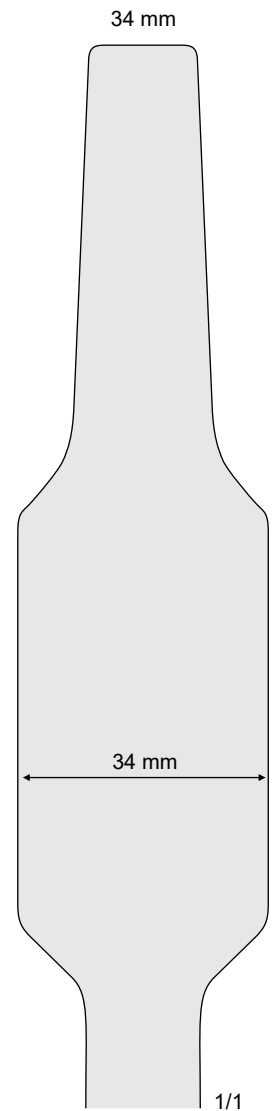

E 1257-02
28.5 cm

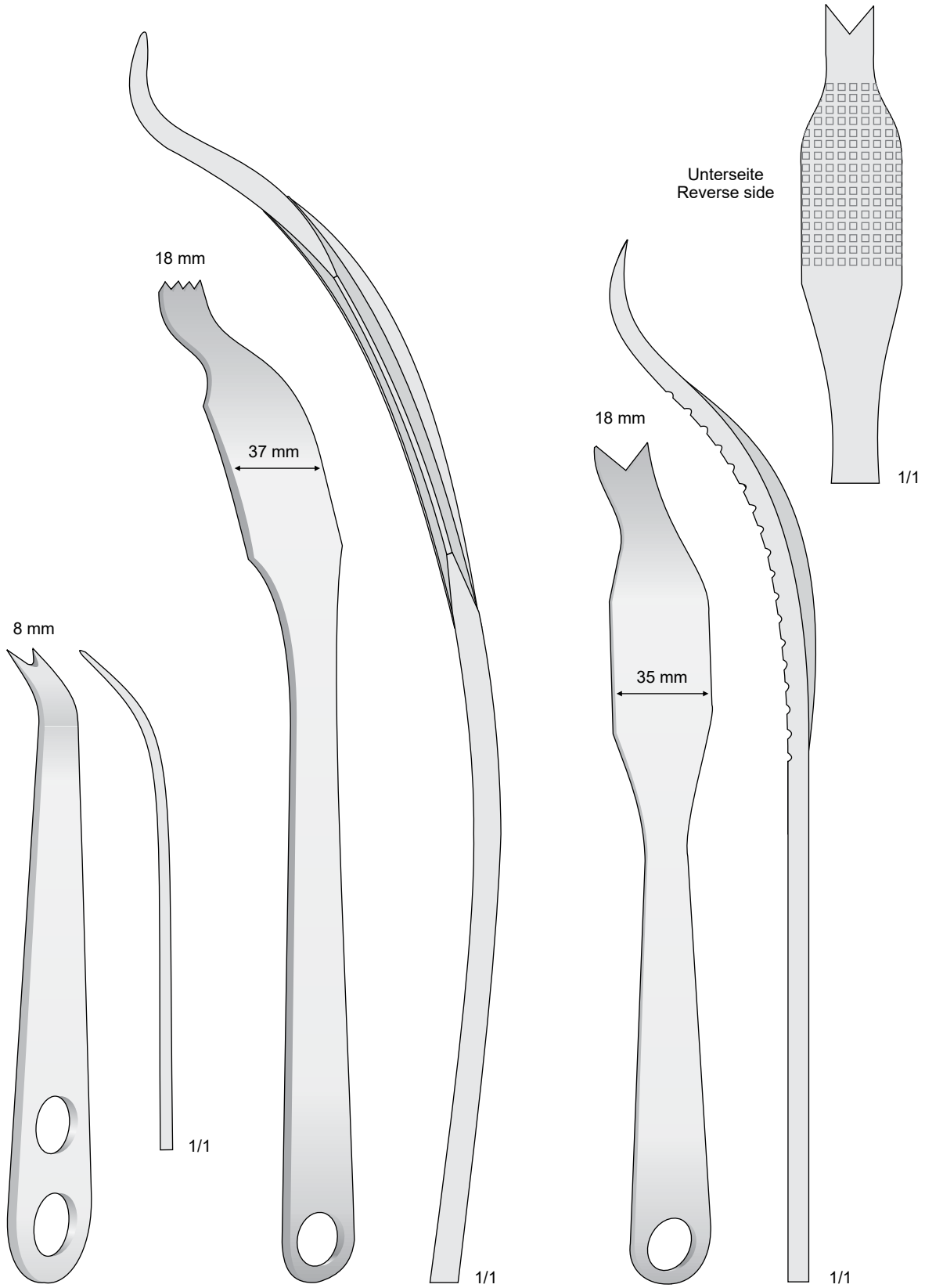

E 1258-14 14 cm

SCHUMACHER mod. WAGNER
E 1259-34 34.5 cm

SCHUMACHER
E 1260-28 28.5 cm

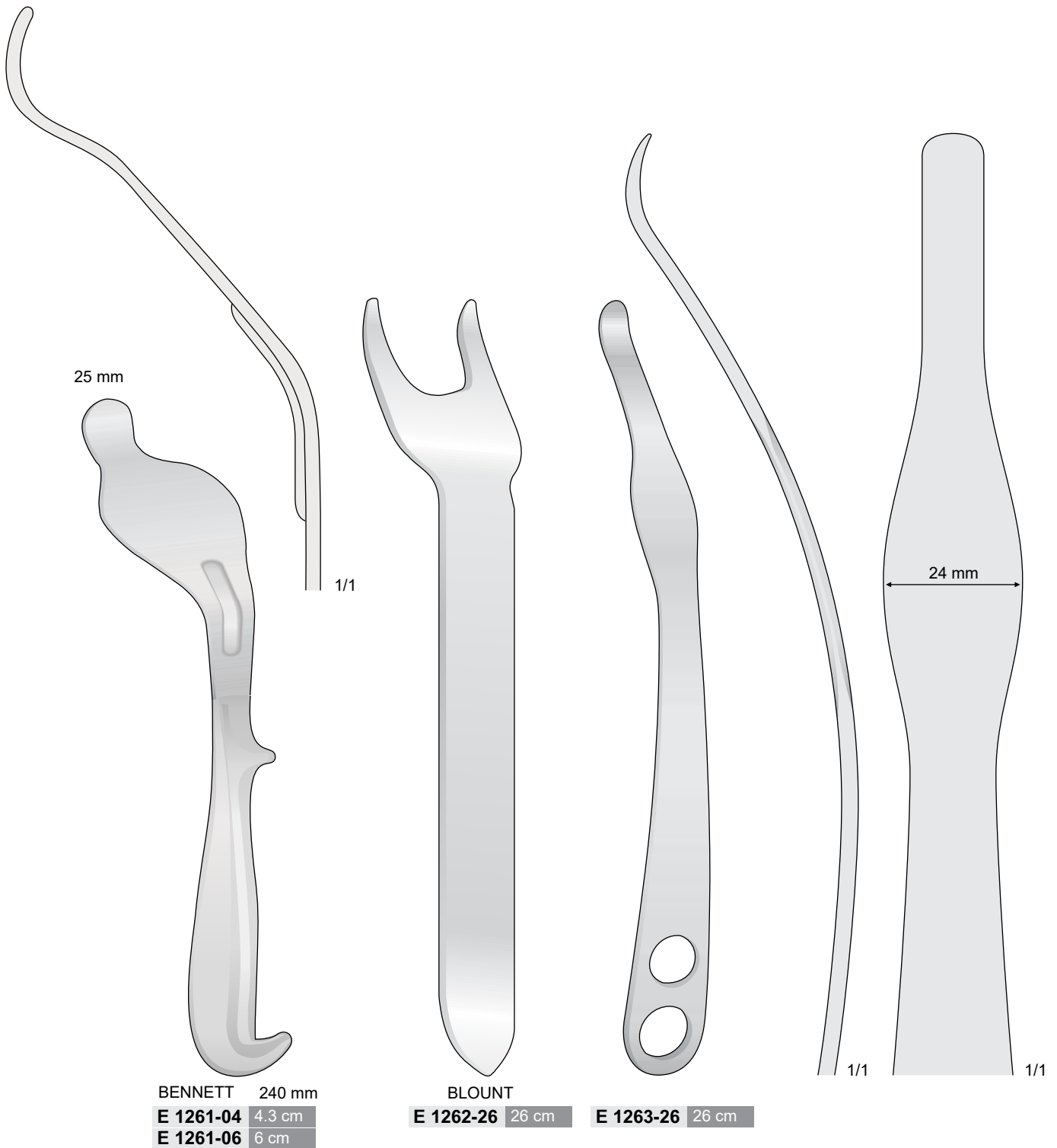

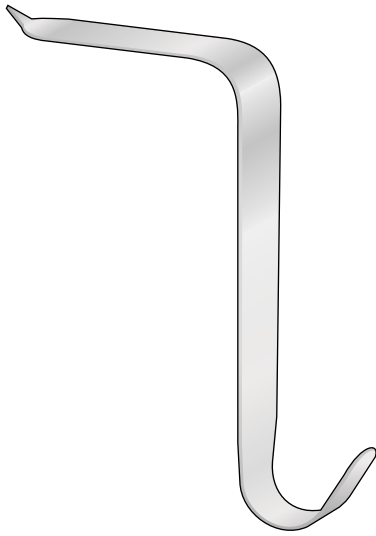

TAYLOR 16.5 cm
E 1264-01 75x30 mm
E 1264-02 100x30 mm

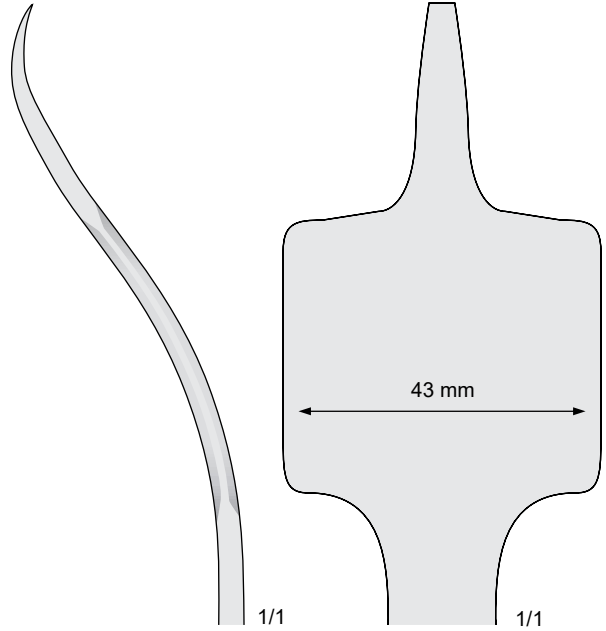

E 1266-01

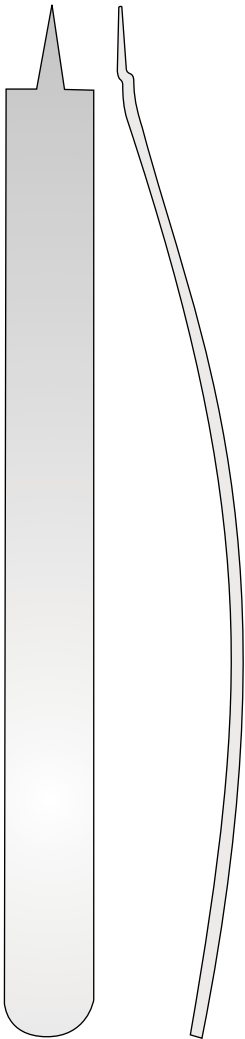

E 1265-25 25 cm

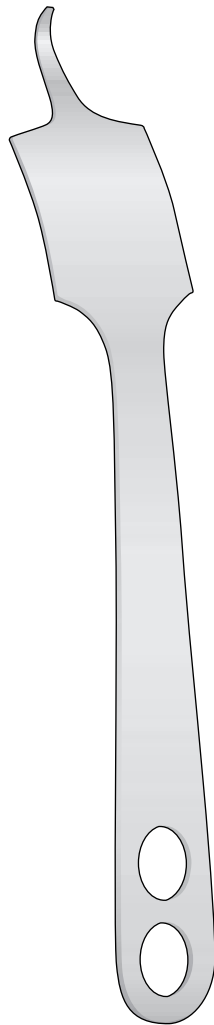

HOHMANN
E 1266-01 / E 1266-02
 24 cm

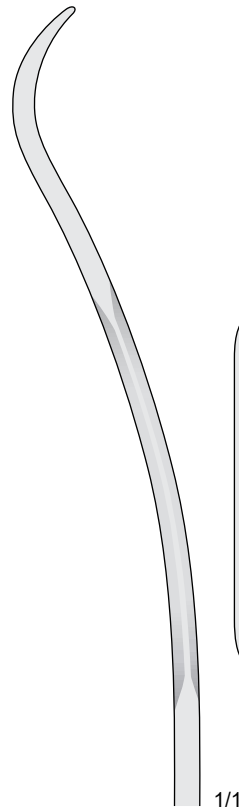

E 1266-02



WEST
E 1267-18 18.5 cm

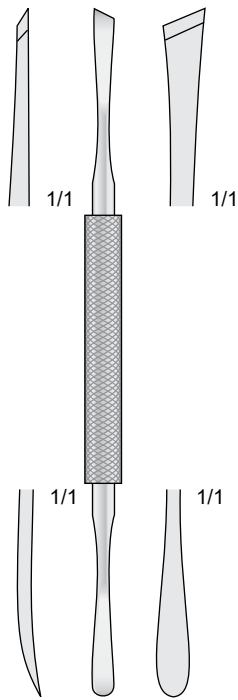

MEAD
E 1268-16 16.5 cm



ALDERDYCE
E 1269-21 21 cm

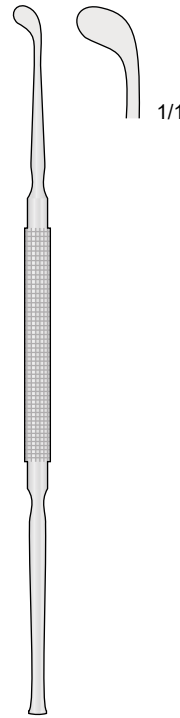

FREER
E 1270-19 19 cm

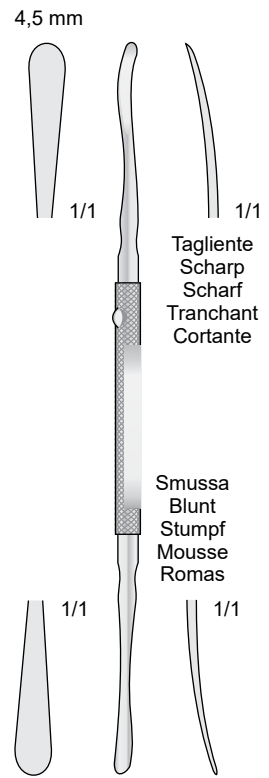

FREER
E 1271-18 18 cm

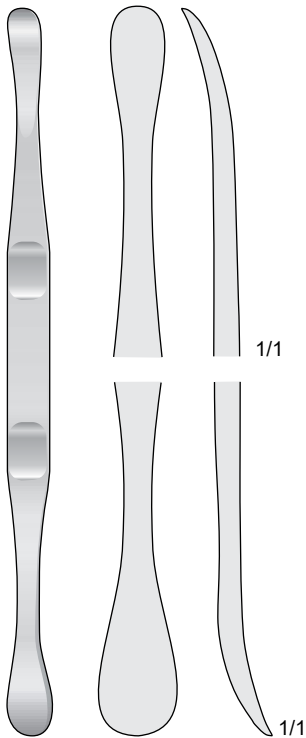

BABBUSH
E 1272-18 18 cm

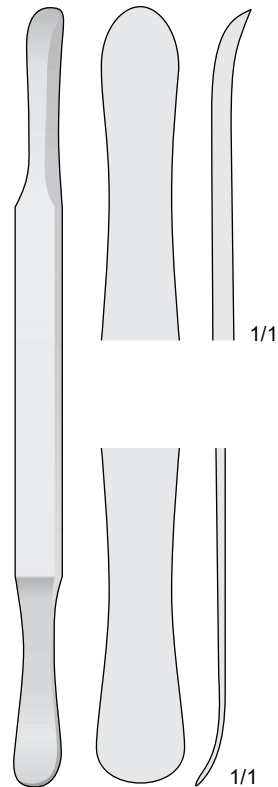

SELDIN
E 1273-19 19.5 cm

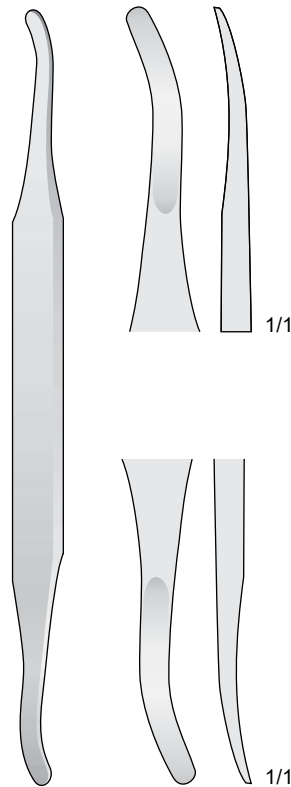

SELDIN
E 1274-19 19 cm

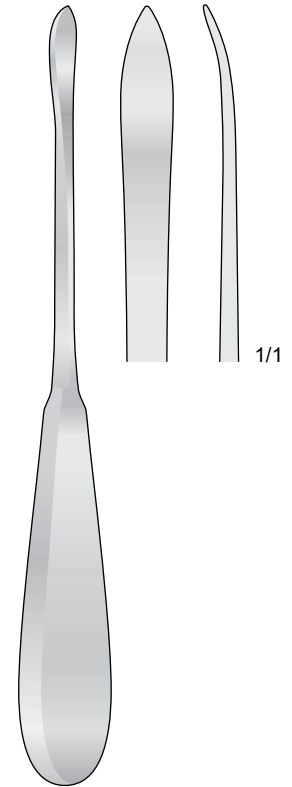

LANGENBECK
E 1275-20 20 cm

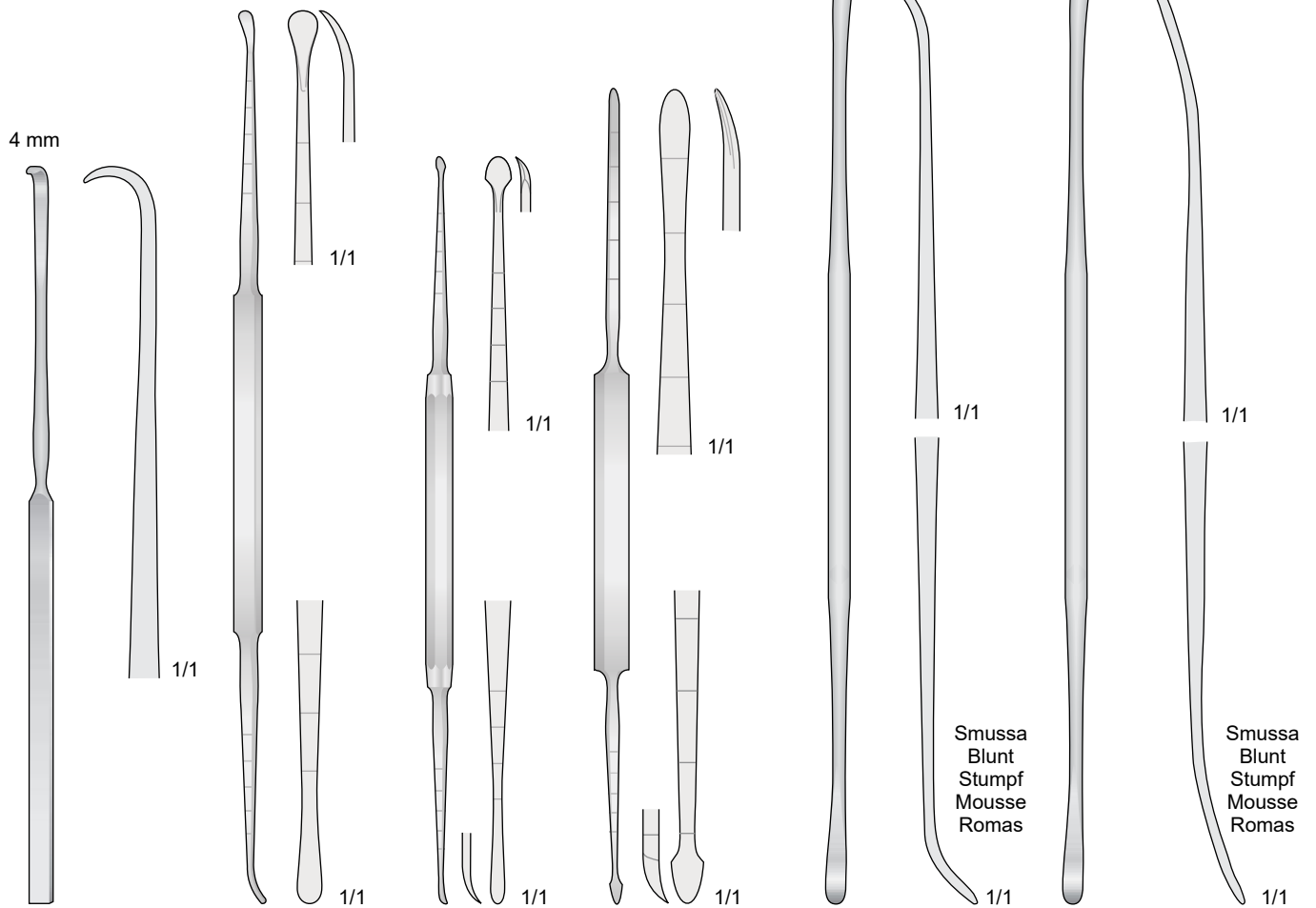

R 1276-20 20 cm

COTTLE
R 1277-22 22 cm

MASING
R 1278-21 21 cm

COTTLE
R 1279-21 21 cm

SALZBURG
R 1280-24 24.5 cm

SALZBURG
R 1281-24 24.5 cm

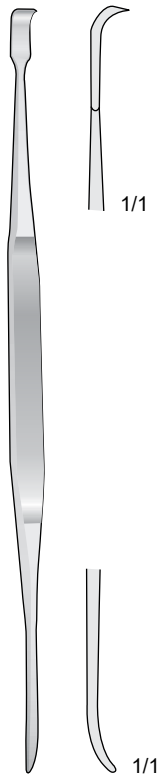

HOWARTH
R 1282-21 21 cm



MC DONALD
R 1283-19 19 cm

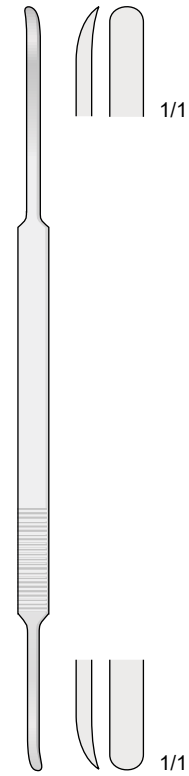

MCKENTY
R 1284-22 22 cm

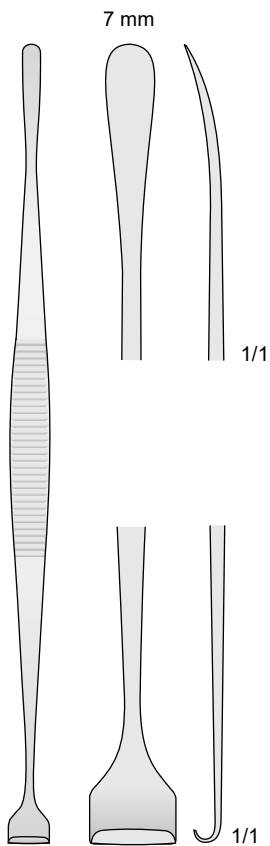

HURD
R 1285-22 22 cm

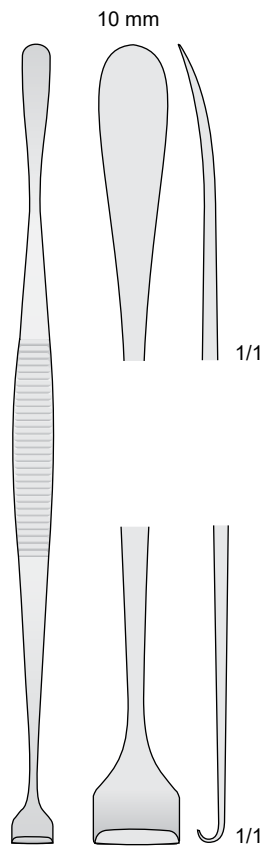

HURD
R 1286-22 22 cm

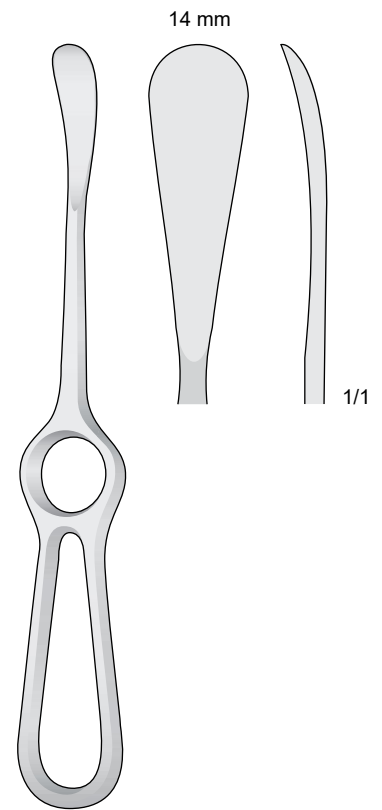

SEDILLOT
R 1287-21 21 cm

Periosteal elevators
Taglienti
Sharp
Scharf
Tranchant
Cortante

6 mm

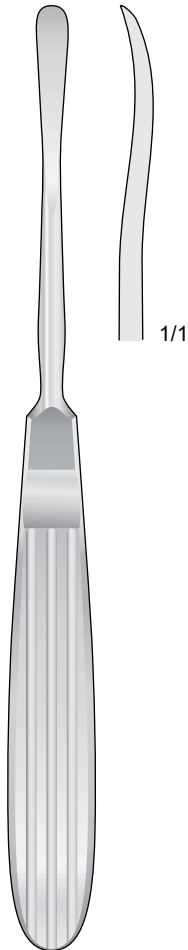

OBWEGESER

R 1288-17 17.5 cm

7 mm

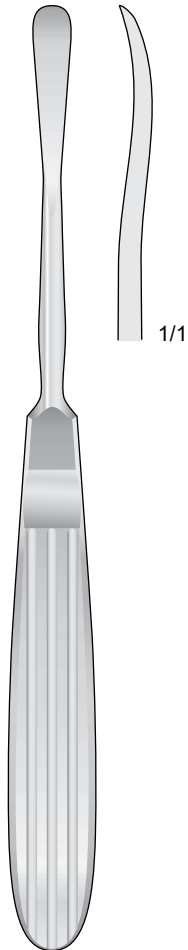

OBWEGESER

R 1289-17 17.5 cm

9 mm



OBWEGESER

R 1290-17 17.5 cm

11 mm



OBWEGESER

R 1291-17 17.5 cm

Sinistra, tagliente
 Left, sharp
 Links, Scharf
 À gauche, tranchant
 A la izquierda, cortante

Destra, tagliente
 Right, sharp
 Rechts, Scharf
 À droite, tranchant
 A la derecha, cortante



R 1292-01

R 1292-02

OBWEGESER

R 1292-01 / R 1292-02

19 cm

5 mm

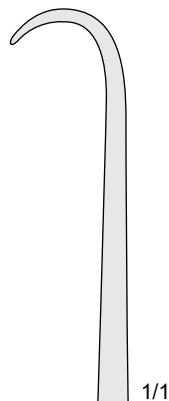

1/1

7 mm

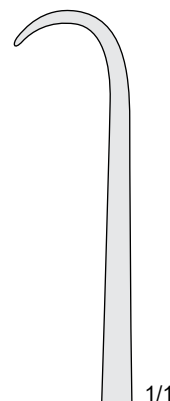

1/1

R 1293-20 20 cm

R 1294-20 20 cm

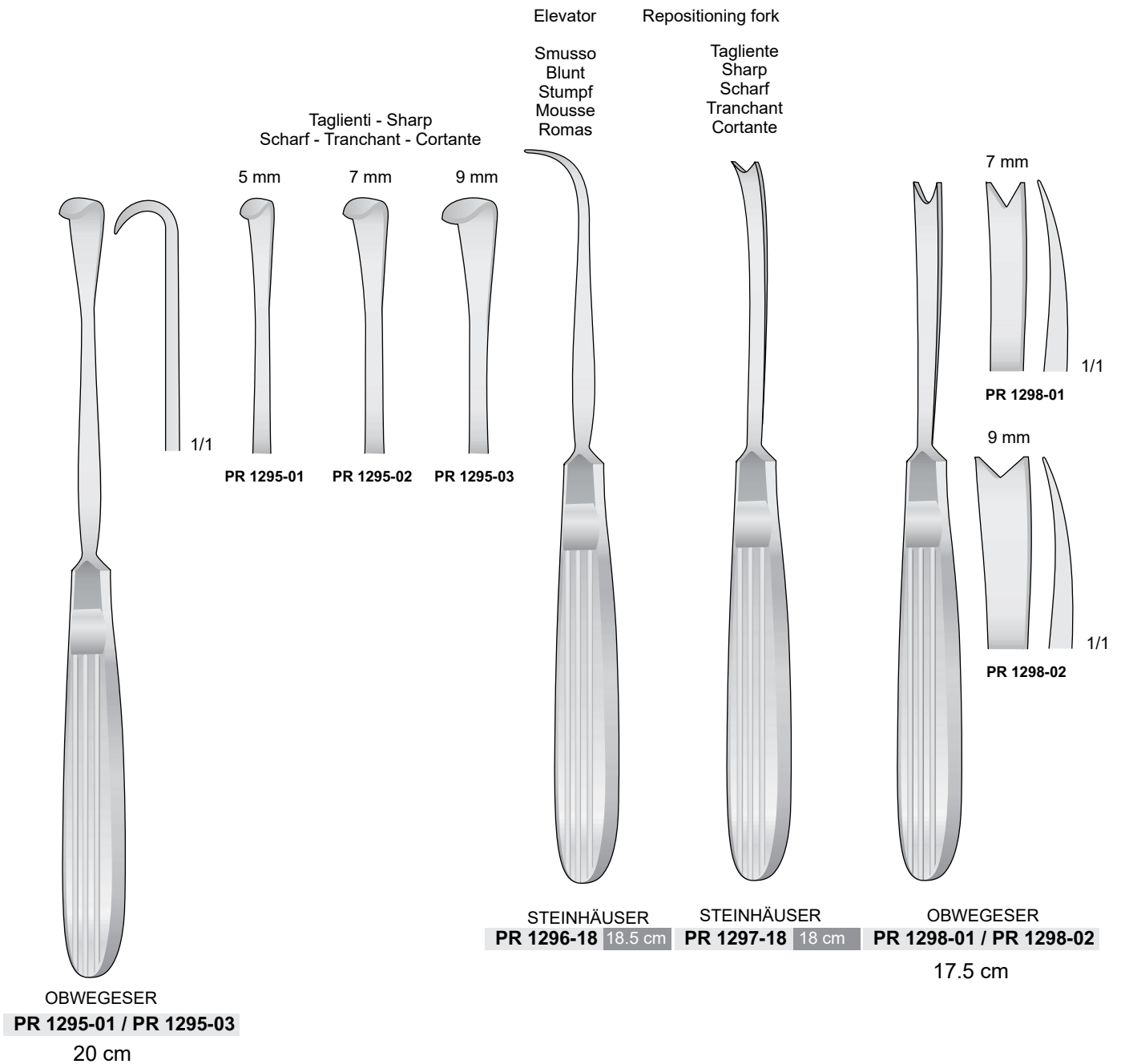

15 mm

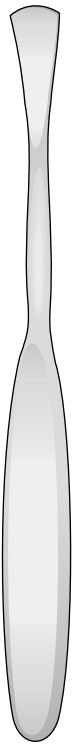

CUSHING

PR 1299-19 19 cm

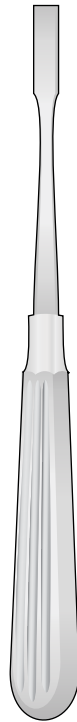

ADSON

PR 1300-01 / PR 1300-04
17 cm

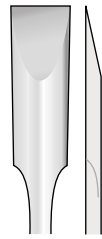

PR 1300-01
80 mm

1/1



PR 1300-02
70 mm

1/1



PR 1300-03
70 mm

1/1

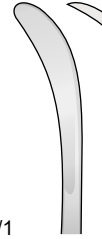

PR 1300-04
70 mm

1/1

2,5 mm

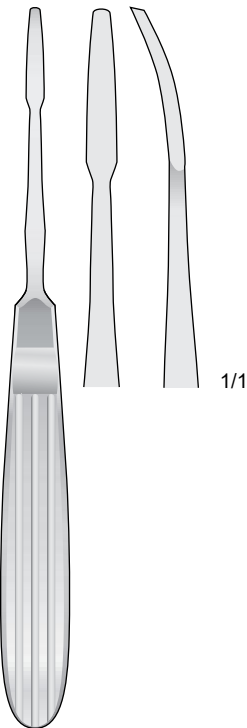

JOSEPH

PR 1301-17 17 cm

1/1

7 mm

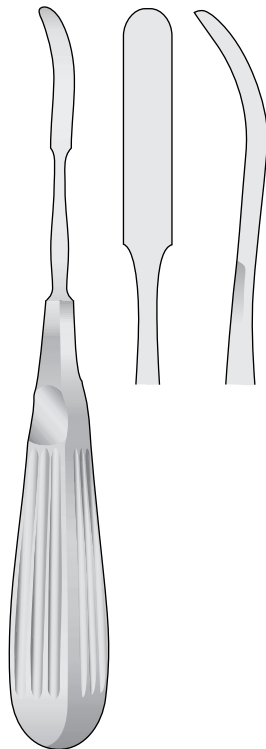

JOSEPH

PR 1302-18 18 cm

1/1

10 mm



MOLT

PR 1303-16 16 cm

10 mm

12 mm

15 mm

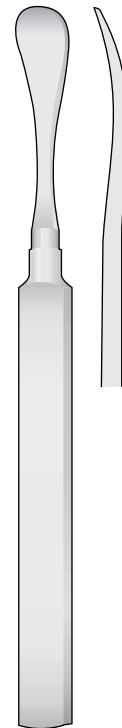

HENAHAN

1/1

1/1

1/1

PR 1304-01 **PR 1304-02** **PR 1304-03**

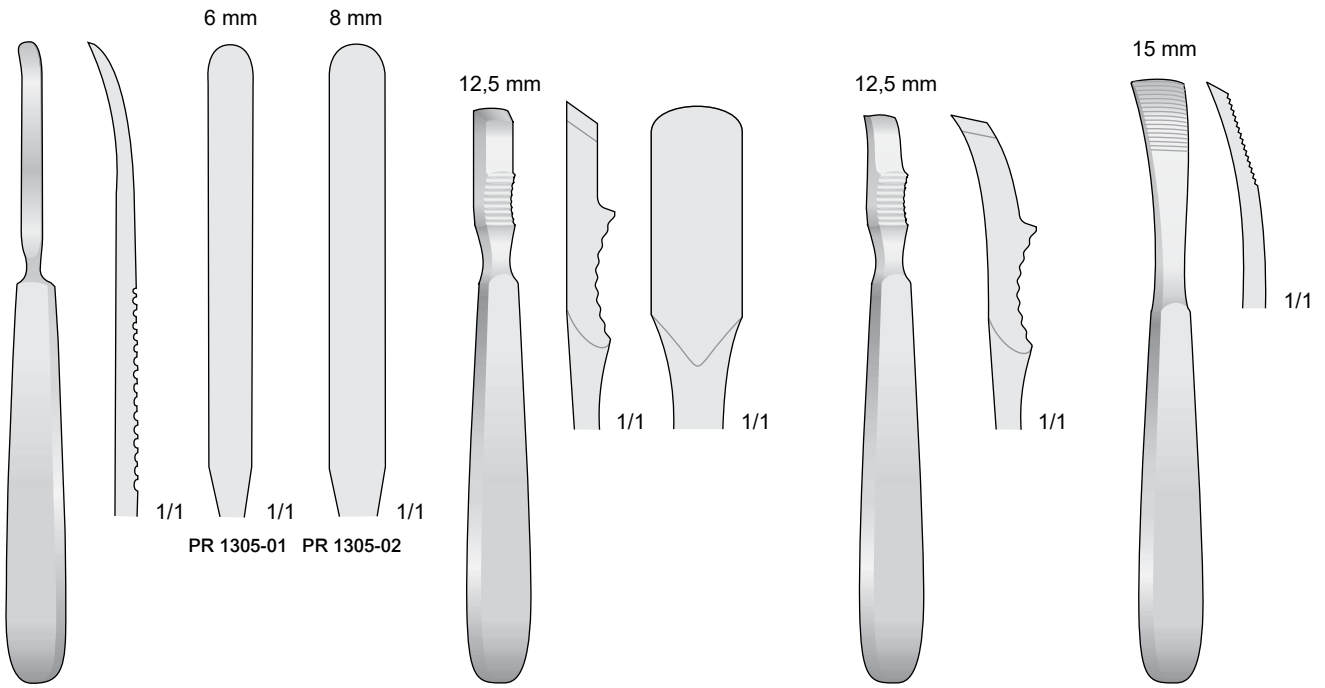

PR 1305-01 / PR 1305-02
17 cm

FARABEU
PR 1306-15 15 cm

FARABEU
PR 1307-15 15 cm

JANSEN
PR 1308-16 16.5 cm

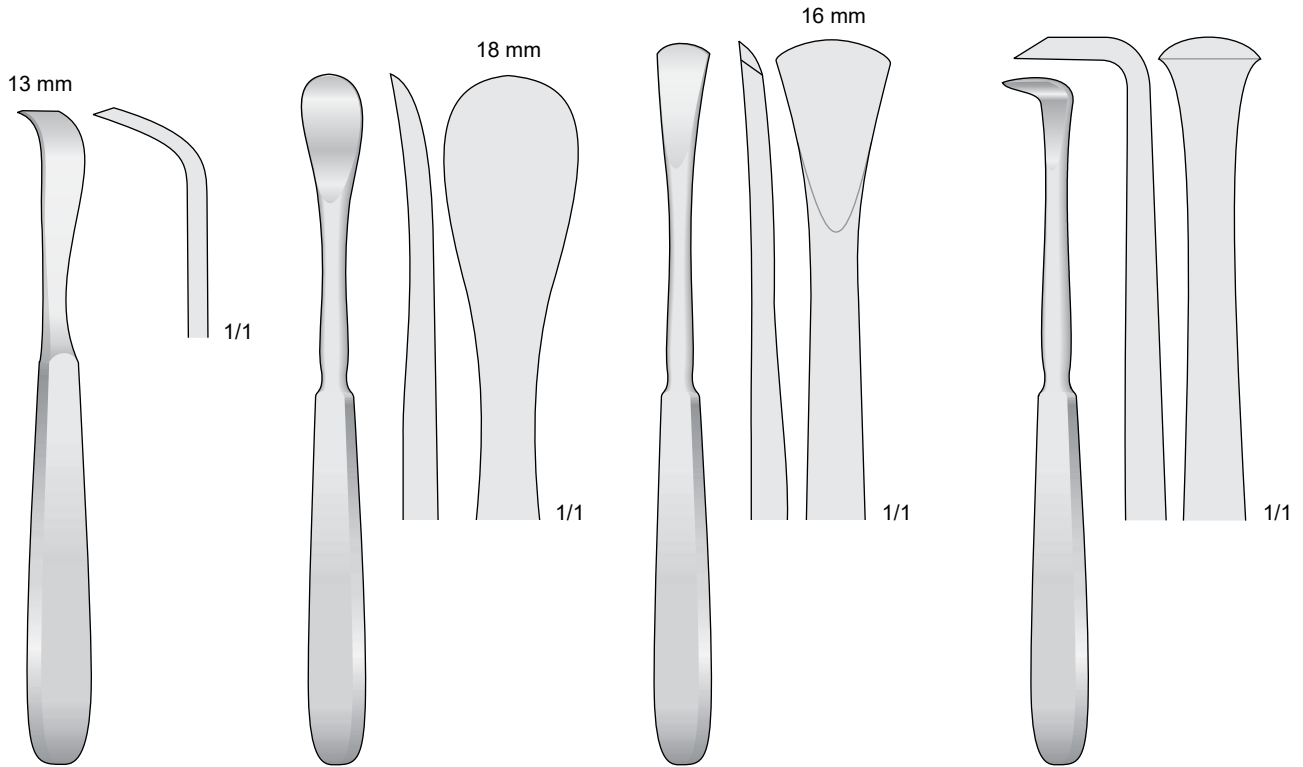

SCHNEIDER
PR 1309-17 17.5 cm

SEDILLOT
PR 1310-18 18.5 cm

LANGENBECK
PR 1311-19 19 cm

LANGENBECK
PR 1312-18 18 cm

Sinus
 Hipophisectomia

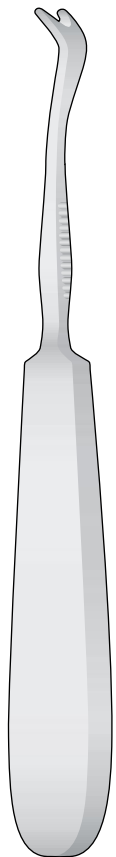

SEMB

PR 1313-01 / PR 1313-05

Sinus and
 Hypophisectomy

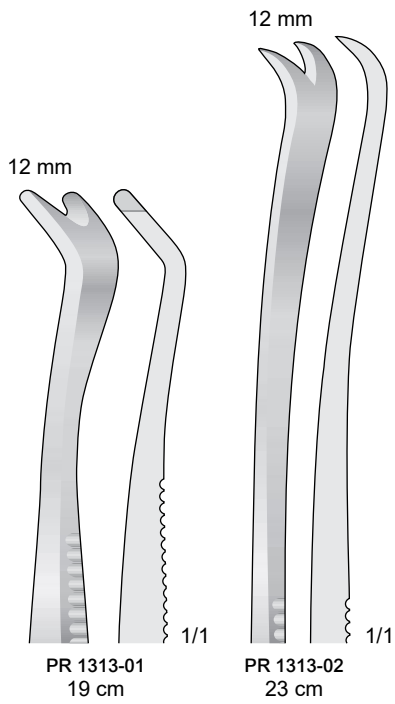

Sinus und
 Hypophisectomie

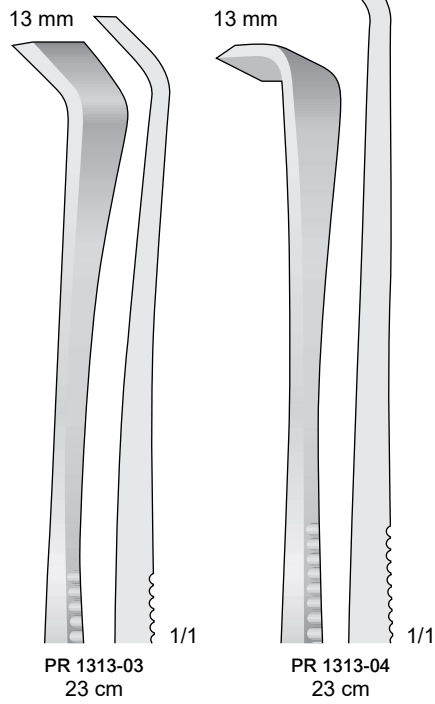

Elevation e dissezion
 de apofisi zigomatica

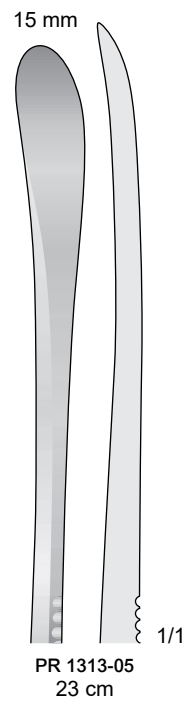

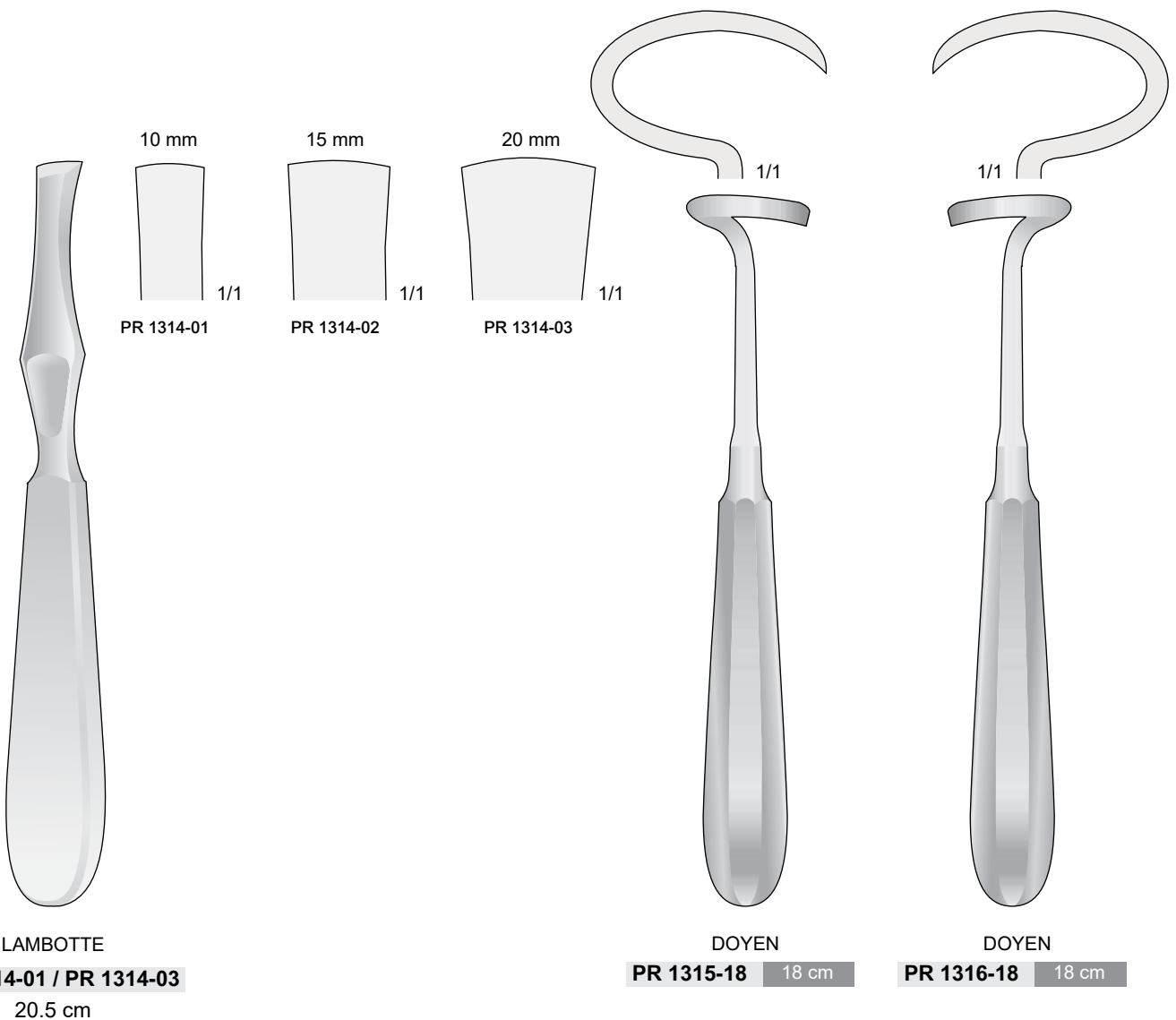

Periostotomi - Raspatori
Periosteal Raspatories
Raspatorien
Rugines à périostomie
Periostotomos - Legras

Con manico Ferrozell
With Ferrozell handle
Mit Ferrozellgriff
Avec poignée en Ferrozell
Con mango de Ferrozell

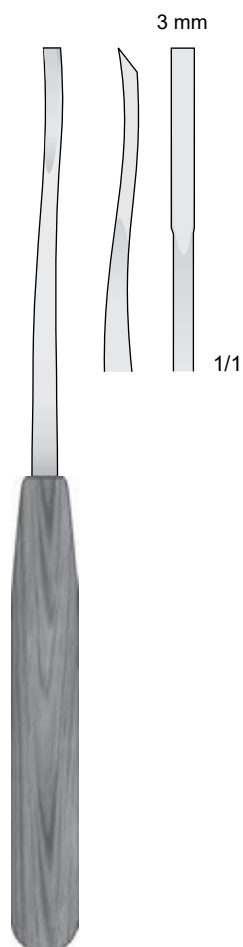

PR 1317-18 18 cm



PR 1318-19 19 cm

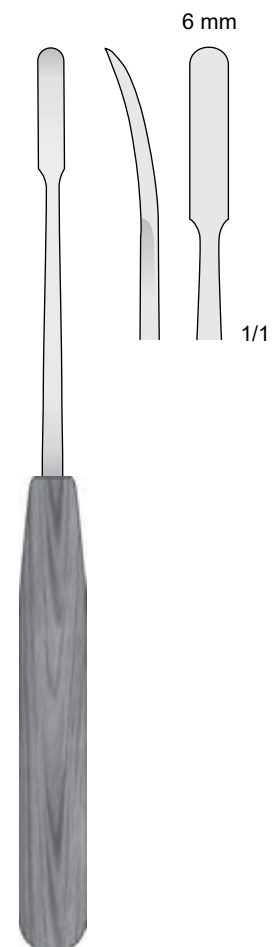

PR 1319-19 19 cm

Con manico Ferrozell
 With Ferrozell handle
 Mit Ferrozellgriff
 Avec poignée en Ferrozell
 Con mango de Ferrozell

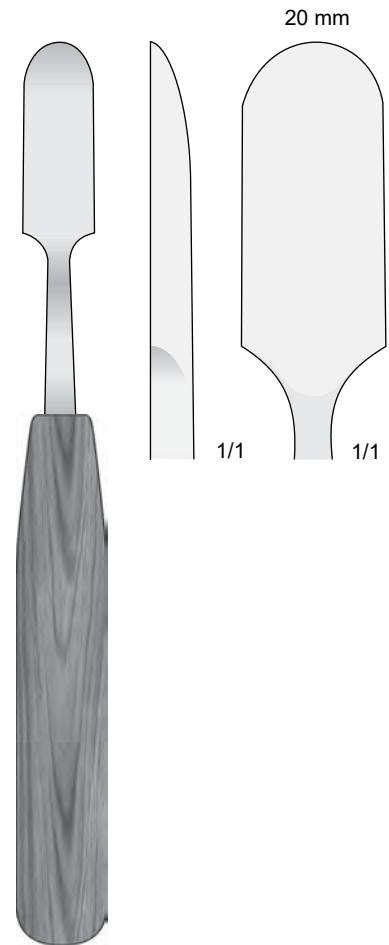
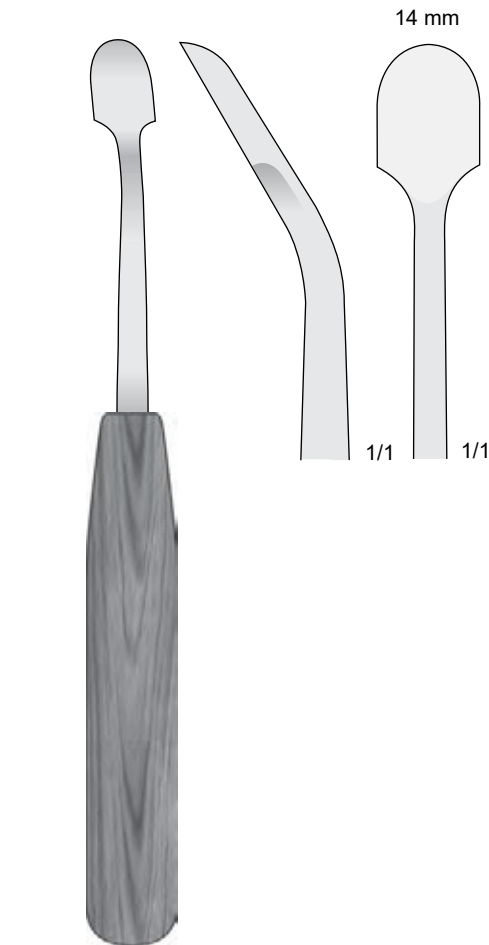
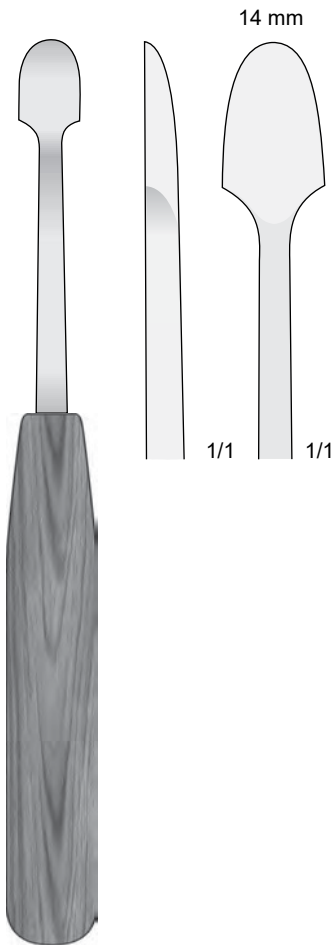

PR 1320-20 20 cm

PR 1321-20 20 cm

PR 1322-20 20 cm

Periostotomi - Raspatori
Periosteal Raspatories
Raspatorien
Rugines à périostomie
Periostotomos - Legras

Con manico Ferrozell
With Ferrozell handle
Mit Ferrozellgriff
Avec poignée en Ferrozell
Con mango de Ferrozell

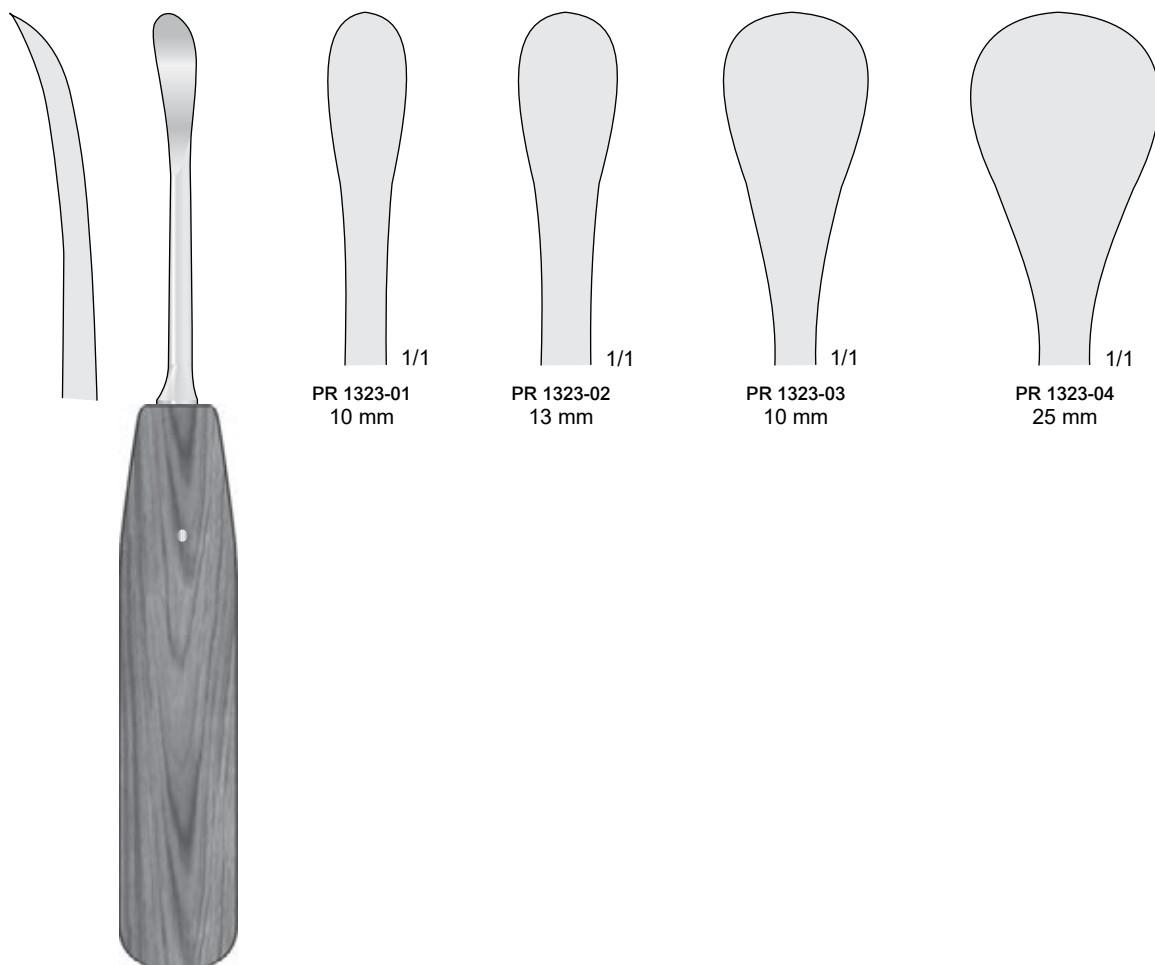

COBB

PR 1323-01 / PR 1323-04

25 cm

Fig. 67

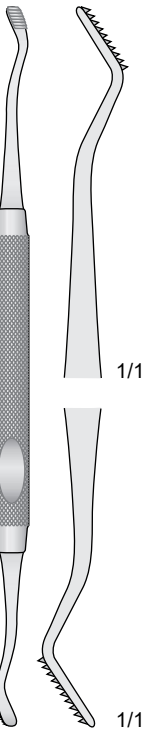

HOWARD

BF 1324-18 18 cm

Fig. 45

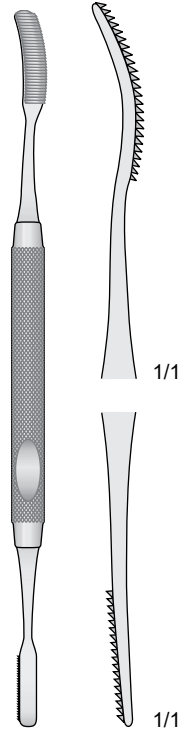

MILLER

BF 1325-18 18.5 cm

Fig. 52

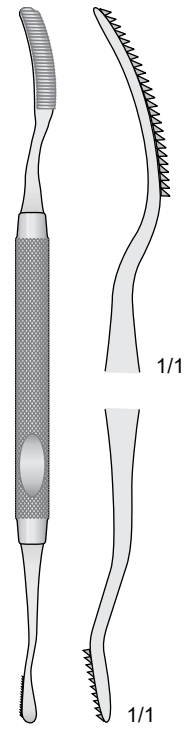

MILLER

BF 1326-18 18 cm

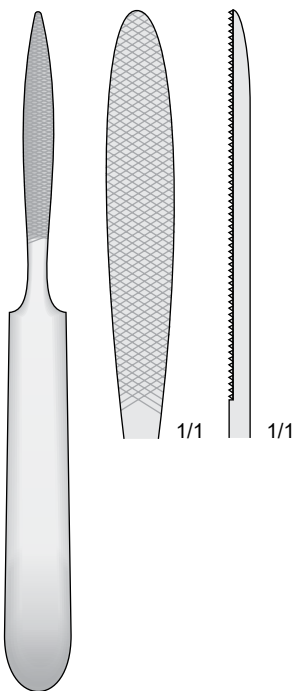

JOSEPH

BF 1327-16 16 cm

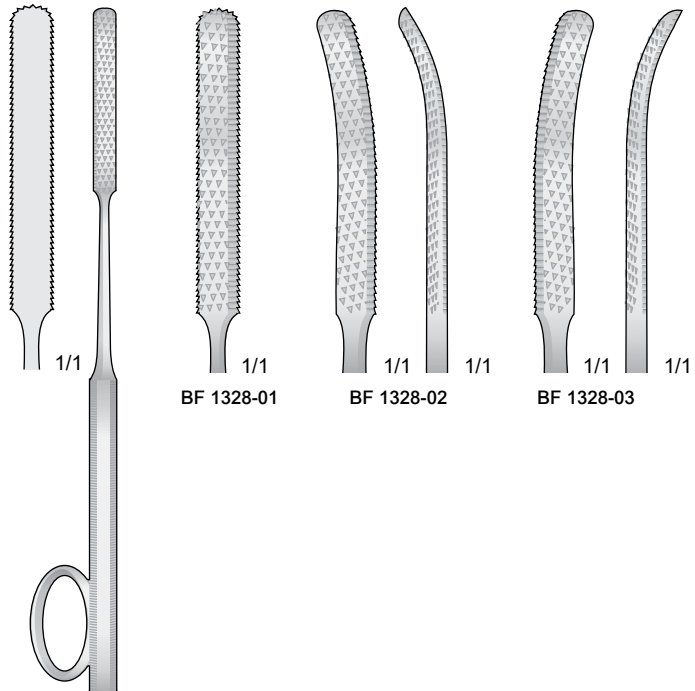

GALLAHER

BF 1328-01 / BF 1328-03
16 cm

Lime per osso
 Bone files
 Knochenfeilen
 Limes à os
 Limas para huesos

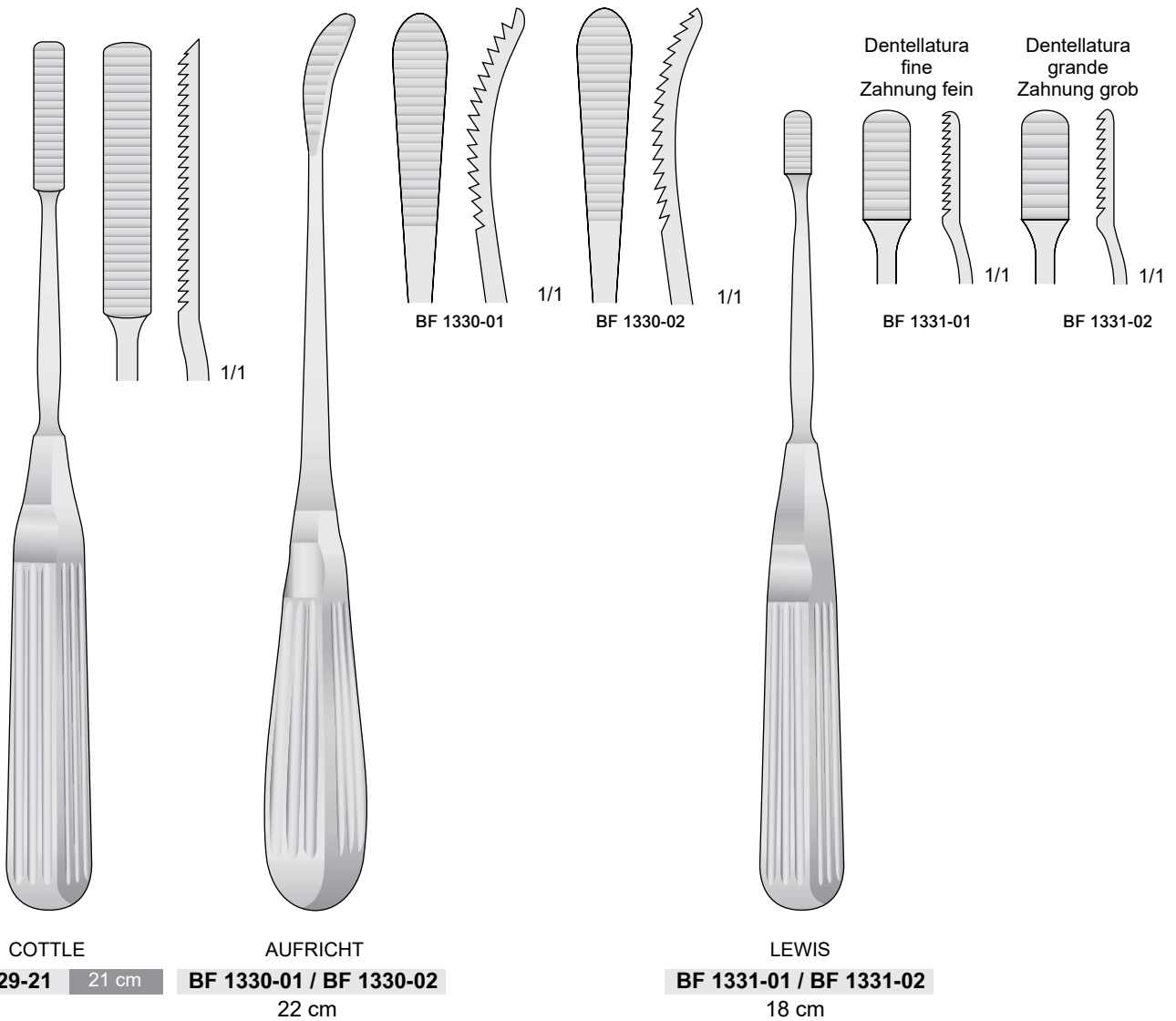

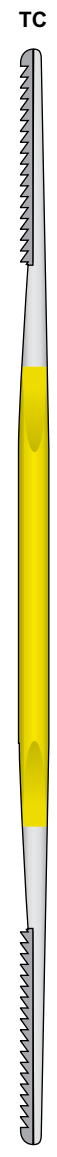

FOMON

BF 1332-01 / BF 1332-05
20 cm



1



3

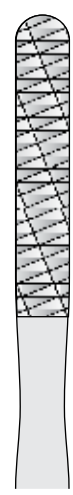

5



7



9



2



4



6

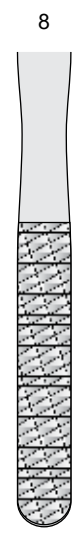

8



10

BF 1332-01

BF 1332-02

BF 1332-03

BF 1332-04

BF 1332-05

Lime per osso
Bone files
Knochenfeilen
Limes à os
Limas para huesos

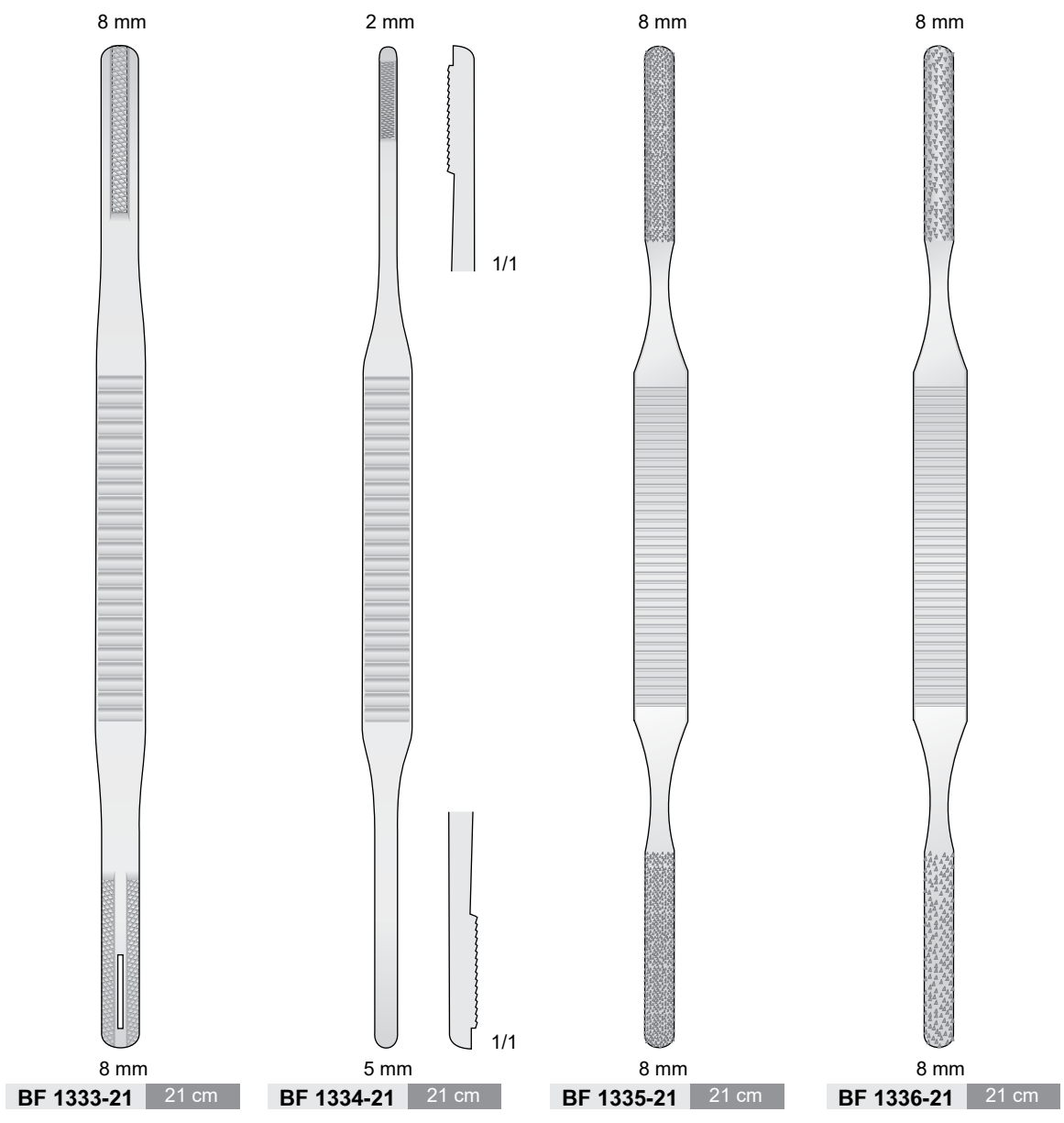

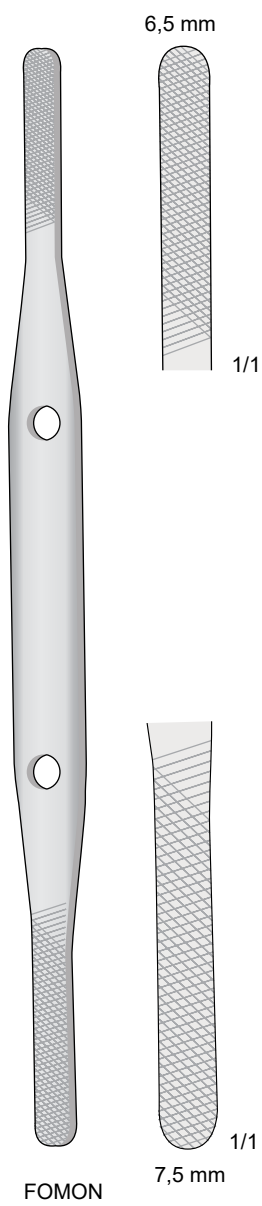

BF 1337-21 21 cm

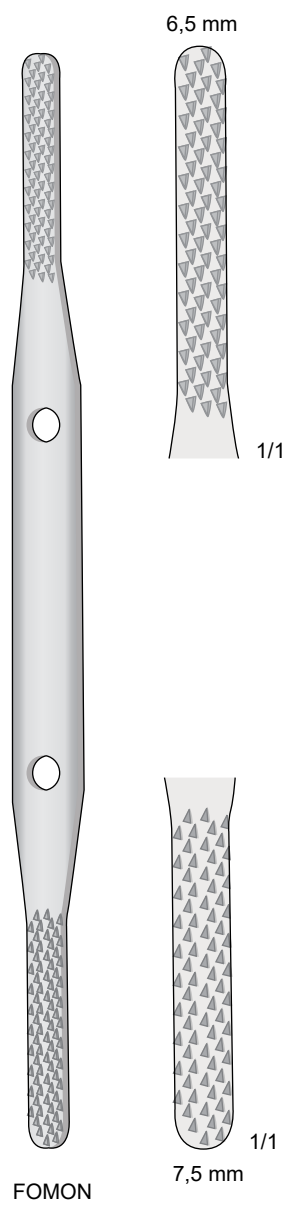

BF 1338-21 21 cm

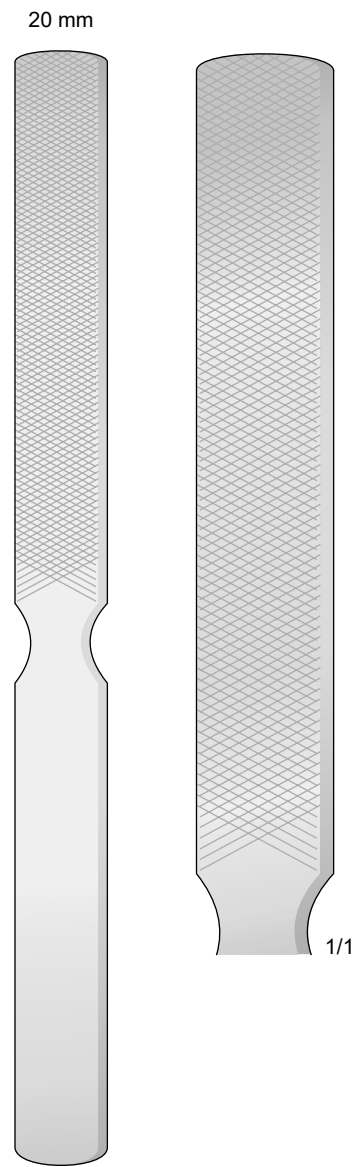

BF 1339-22 22 cm

Lime per osso
Bone files
Knochenfeilen
Limes à os
Limas para huesos

20 mm



BF 1340-29 29.5 cm

13 mm

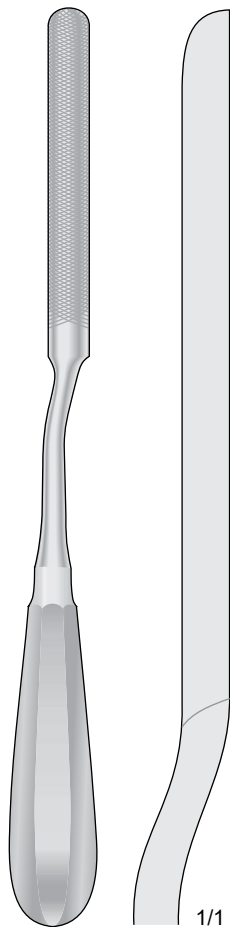

BF 1341-24 24 cm

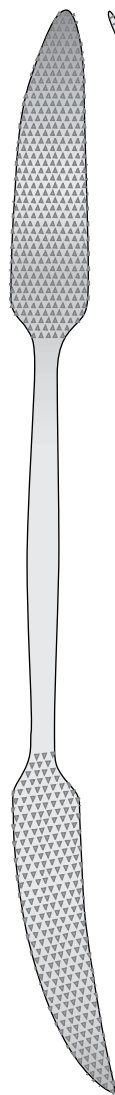

PUTTI
BF 1342-27 27 cm



1/1

1/1

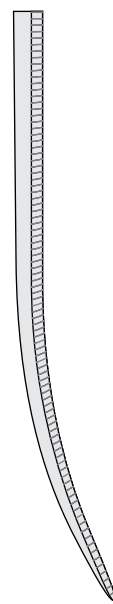

1/1

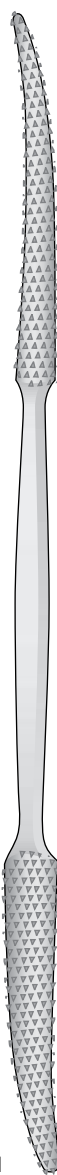

PUTTI
BF 1343-30 30 cm



1/1



1/1

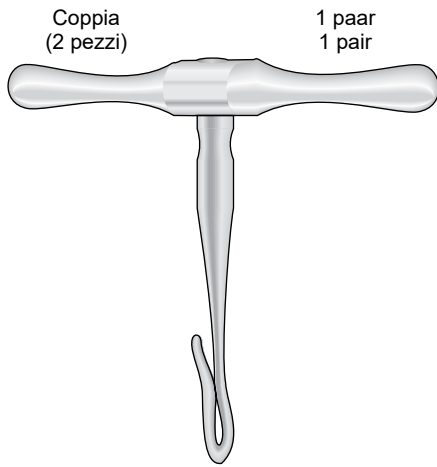

Coppia
(2 pezzi)

1 paar
1 pair

GIGLI
BF 1344

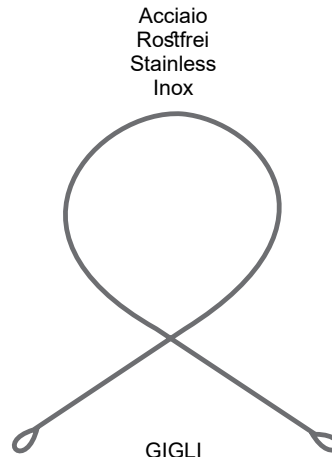

Acciaio
Rostfrei
Stainless
Inox

GIGLI

Code	Size
BF 1345-30	30 cm
BF 1345-50	50 cm

BF 1346-39
Completa con 3 seghe
Complete with 3 saws
Komplett mit 3 Sägen
Complet avec 3 scies
Completo con 3 sierras

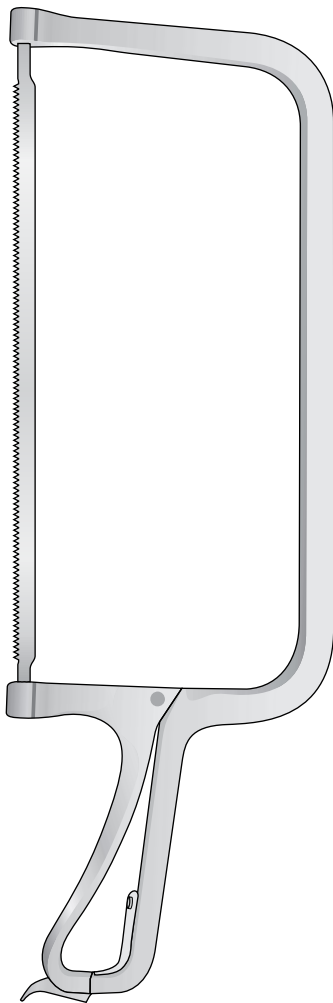

COLLIN

BF 1346-39 39 cm

Fig.1



BF 1346-01
28 cm

Fig.2



BF 1346-02
28 cm

Fig.3



BF 1346-03
28 cm

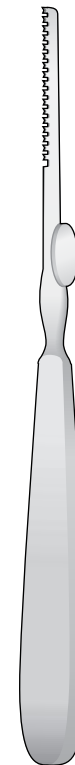

LINDEMANN

BF 1347-20 20 cm



1/1



LANGENBECK

BF 1348-23 23.5 cm

Curette, Cucchiari taglienti
 Sharp currettes
 Scharfe Löffel
 Curettes tranchante
 Cucharillas cortantes

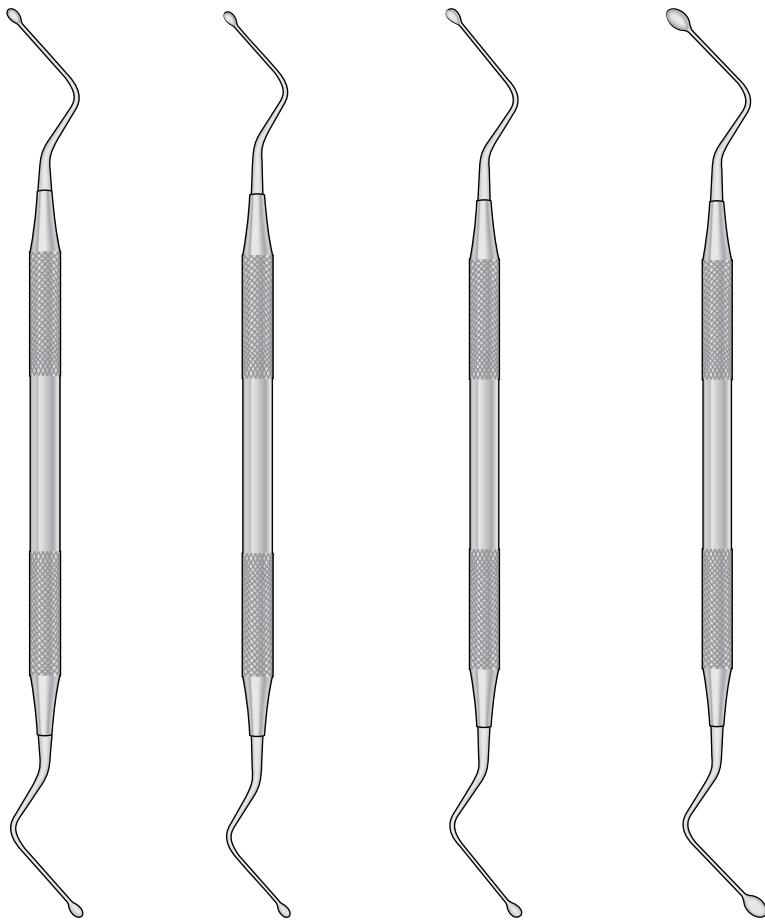

Fig. 1

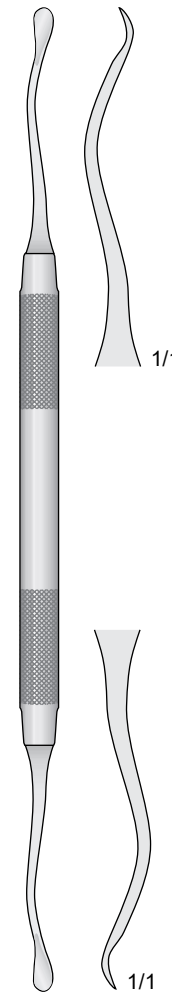
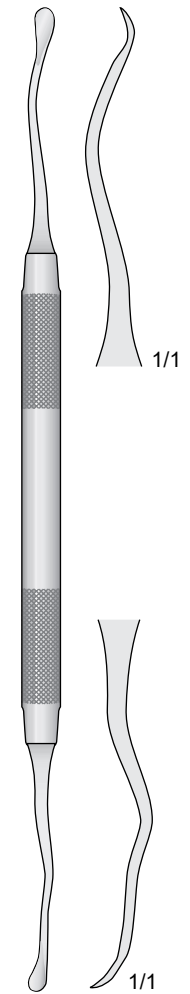
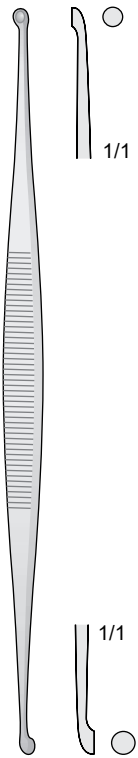

Fig. 2



HEMINGWAY SC 1349-17 17.5 cm HEMINGWAY SC 1350-17 17.5 cm HEMINGWAY SC 1351-17 17.5 cm HEMINGWAY SC 1352-17 17.5 cm SC 1353-20 20 cm SC 1354-19 19.5 cm





MARTINI
SC 1355-14 14 cm

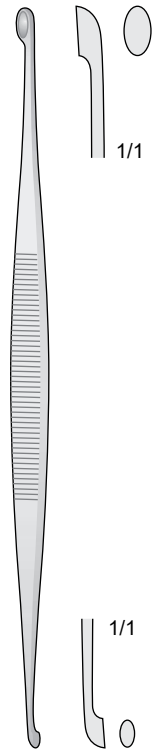

WILLIGER
SC 1356-14 14.5 cm

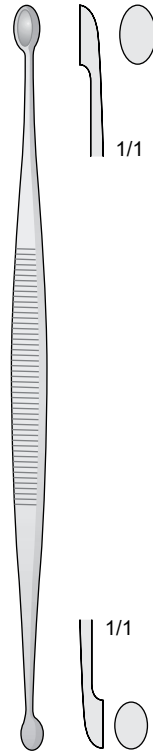

JACOBSON
SC 1357-14 14 cm

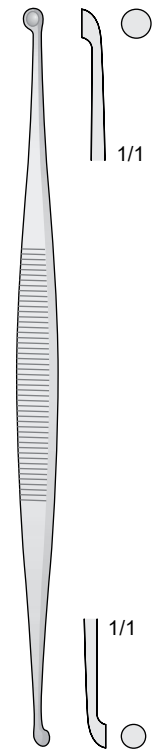

MARTINI
SC 1358-14 14 cm

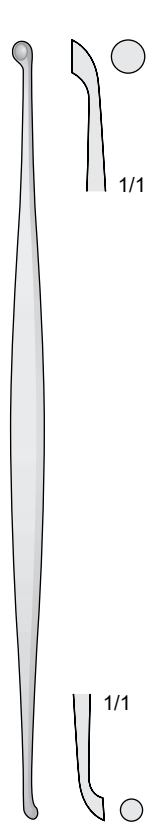

JANSEN
SC 1359-16 16 cm

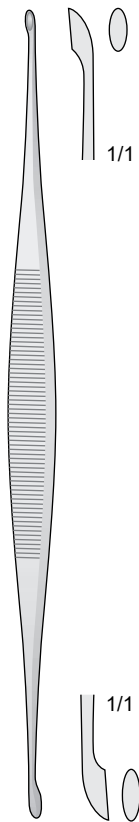

BARTH
SC 1360-18 18 cm

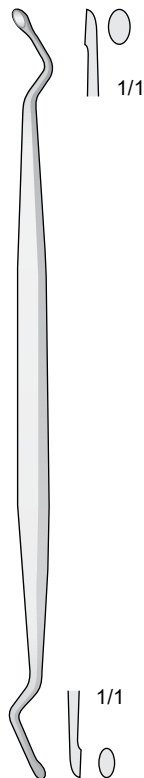

SC 1361-16 16 cm

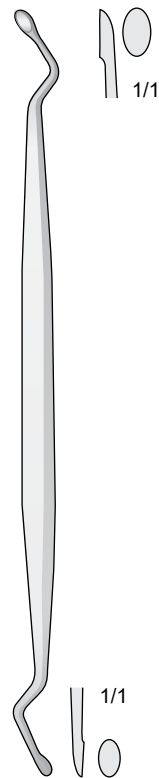

JANSEN
SC 1362-16 16 cm

Curette, Cucchiari taglienti
 Sharp currettes
 Scharfe Löffel
 Currettes tranchante
 Cucharillas cortantes

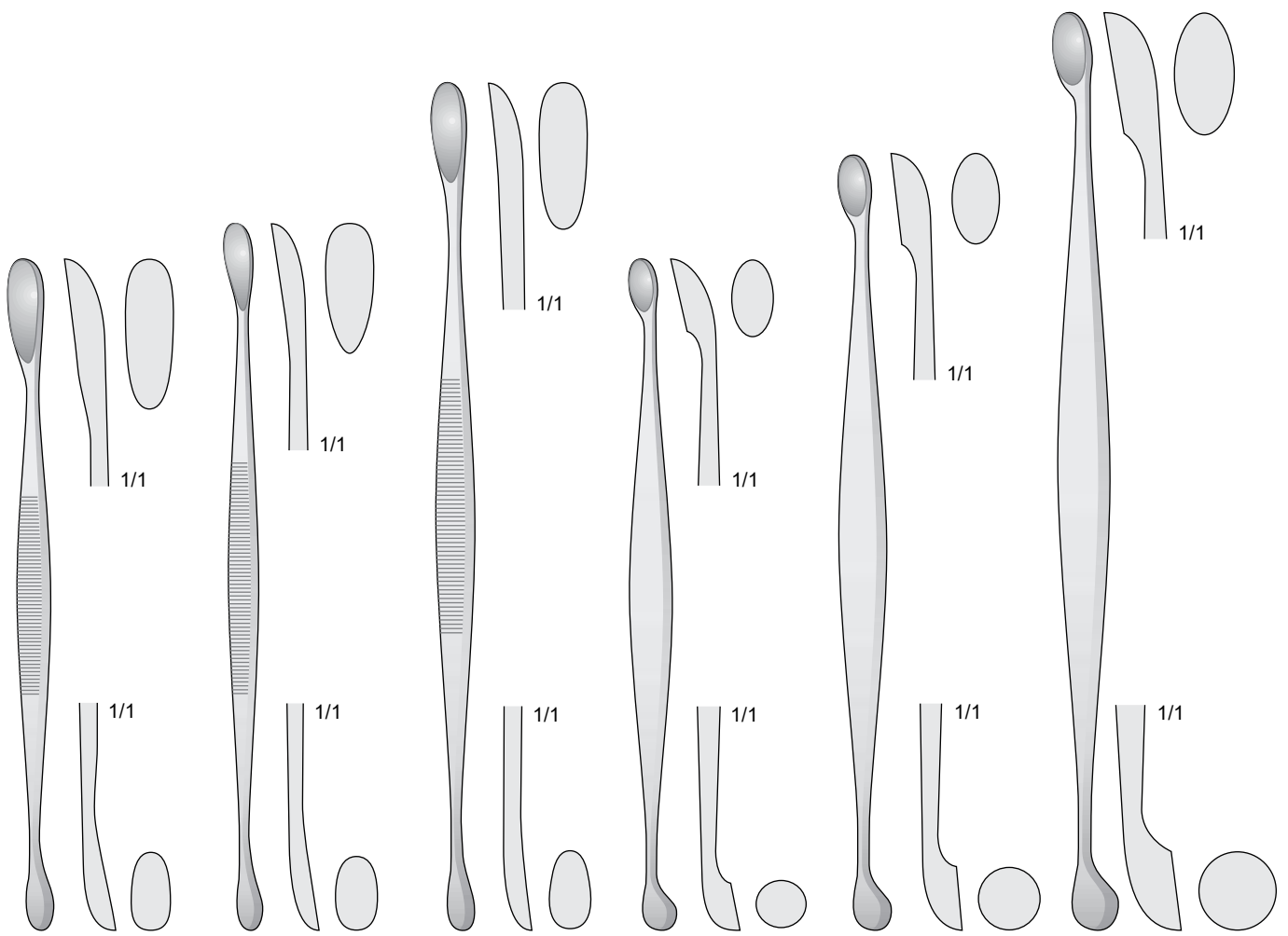

VOLKMANN	VOLKMANN	VOLKMANN	SC 1366-13	SC 1367-16	SC 1368-20
SC 1363-13 13 cm	SC 1364-14 14.5 cm	SC 1365-17 17 cm	13 cm	16 cm	20 cm



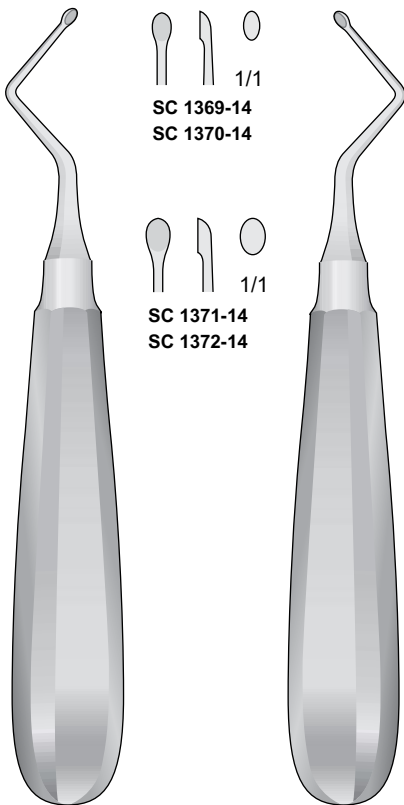

1/1
SC 1369-14
SC 1370-14

1/1
SC 1371-14
SC 1372-14

KERPEL

SC 1369-14 14.5 cm
SC 1371-14 14.5 cm

KERPEL

SC 1370-14 14.5 cm
SC 1372-14 14.5 cm

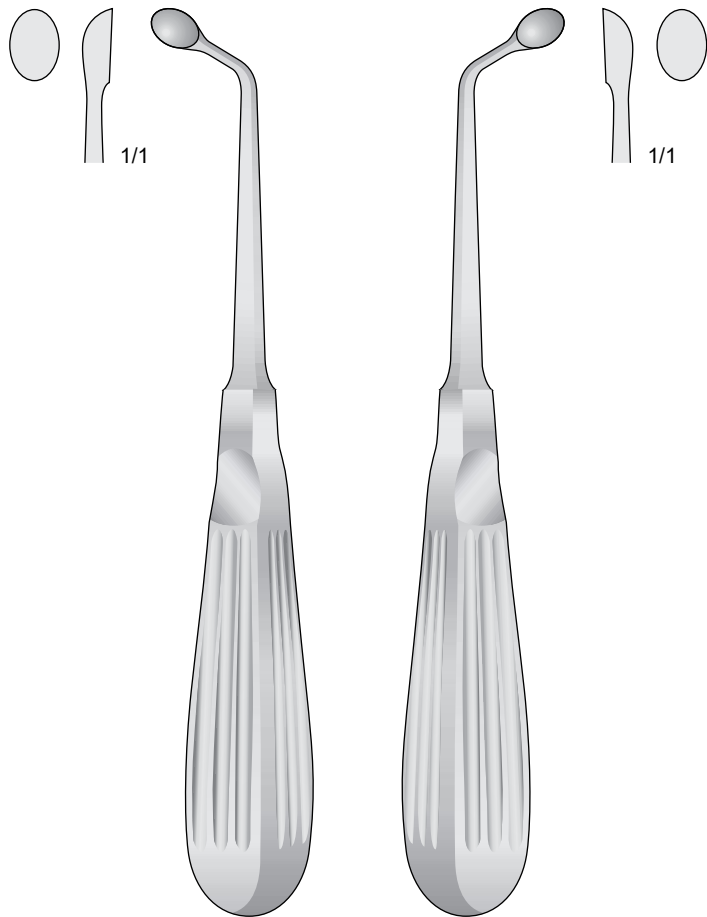

1/1

1/1

UFFENDORDE

SC 1373-17 17 cm

UFFENDORDE

SC 1374-17 17 cm

Curette, Cucchiali taglient
 Sharp currettes
 Scharfe Löffel
 Currettes tranchante
 Cucharillas cortantes

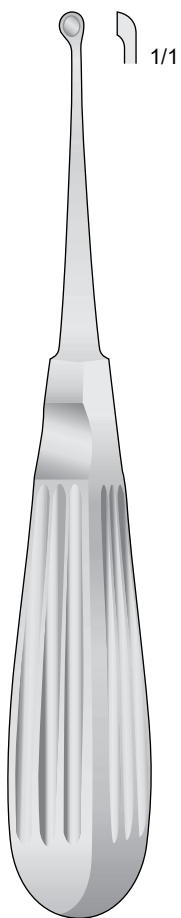

BRUNS

SC 1375-01 / SC 1375-07

16.5 cm

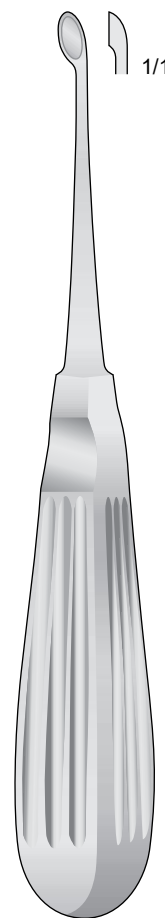
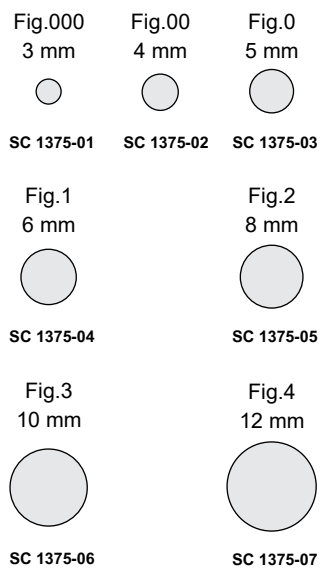

SCHEDE

SC 1376-01 / SC 1376-07

17 cm

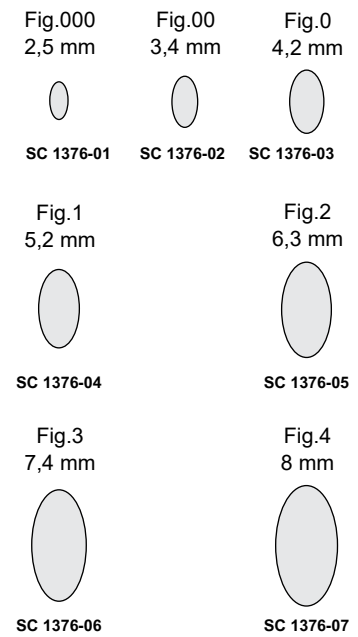

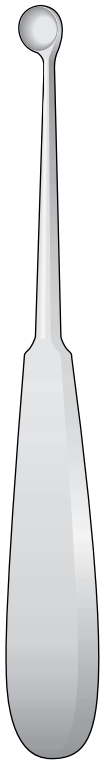

Fig.1
○ 1/1
SC 1377-01

Fig.2
○ 1/1
SC 1377-02

Fig.3
○ 1/1
SC 1377-03

Fig.4
○ 1/1
SC 1377-04

Fig.5
○ 1/1
SC 1377-05

Fig.6
○ 1/1
SC 1377-06

Fig.7
○ 1/1
SC 1377-07

Fig.8
○ 1/1
SC 1377-08

SC 1377-01 / SC 1377-08

18 cm

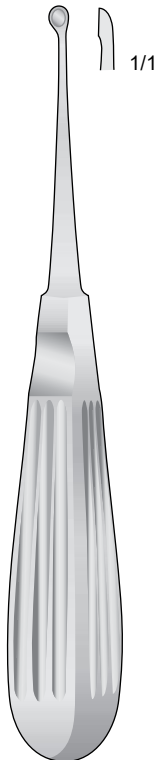

Fig.0000
2,8 mm
○ 1/1
SC 1378-01

Fig.000
3,6 mm
○ 1/1
SC 1378-02

Fig.00
4,4 mm
○ 1/1
SC 1378-03

Fig.0
5,2 mm
○ 1/1
SC 1378-04

Fig.1
6,8 mm
○ 1/1
SC 1378-05

Fig.2
8,5 mm
○ 1/1
SC 1378-06

Fig.3
10 mm
○ 1/1
SC 1378-07

Fig.4
11,5 mm
○ 1/1
SC 1378-08

Fig.5
13 mm
○ 1/1
SC 1378-09

Fig.6
14,5 mm
○ 1/1
SC 1378-10

VOLKMANN

SC 1378-01 / SC 1378-10

17 cm

Curette, Cucchiali taglienti
 Sharp currettes
 Scharfe Löffel
 Currettes tranchante
 Cucharillas cortantes



Fig.1
 1/1
 SC 1379-01

Fig.2
 1/1
 SC 1379-02

Fig.3
 1/1
 SC 1379-03

Fig.4
 1/1
 SC 1379-04

Fig.5
 1/1
 SC 1379-05

Fig.6
 1/1
 SC 1379-06

Fig.7
 1/1
 SC 1379-07

Fig.8
 1/1
 SC 1379-08

Fig.9
 1/1
 SC 1379-09

SC 1379-01 / SC 1379-09

21 cm

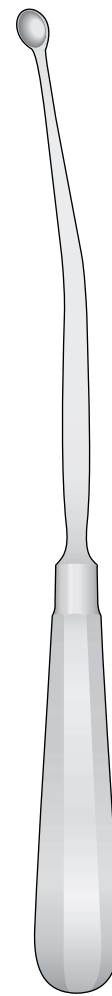

Fig. 1
 1/1
 SC 1380-01

Fig. 2
 1/1
 SC 1380-02

Fig. 3
 1/1
 SC 1380-03

Fig. 4
 1/1
 SC 1380-04

Fig. 5
 1/1
 SC 1380-05

Fig. 6
 1/1
 SC 1380-06

SC 1380-01 / SC 1380-06

26 cm



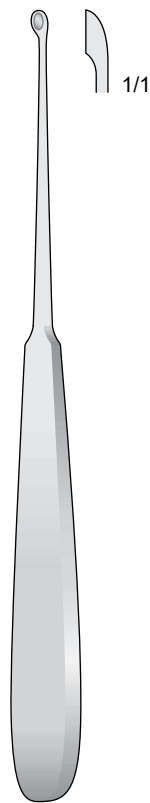

Fig. 00
3,4 mm
1/1
SC 1381-01

Fig. 1
5,2 mm
1/1
SC 1381-02

WILLIGER

SC 1381-01 / SC 1381-02

17 cm

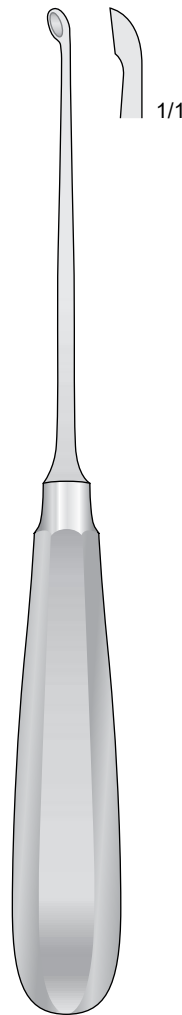

Fig.00
4,4 mm
1/1
SC 1382-01

Fig.0
5,2 mm
1/1
SC 1382-02

Fig.1
6,8 mm
1/1
SC 1382-03

HALLE

SC 1382-01 / SC 1382-03

21.5 cm

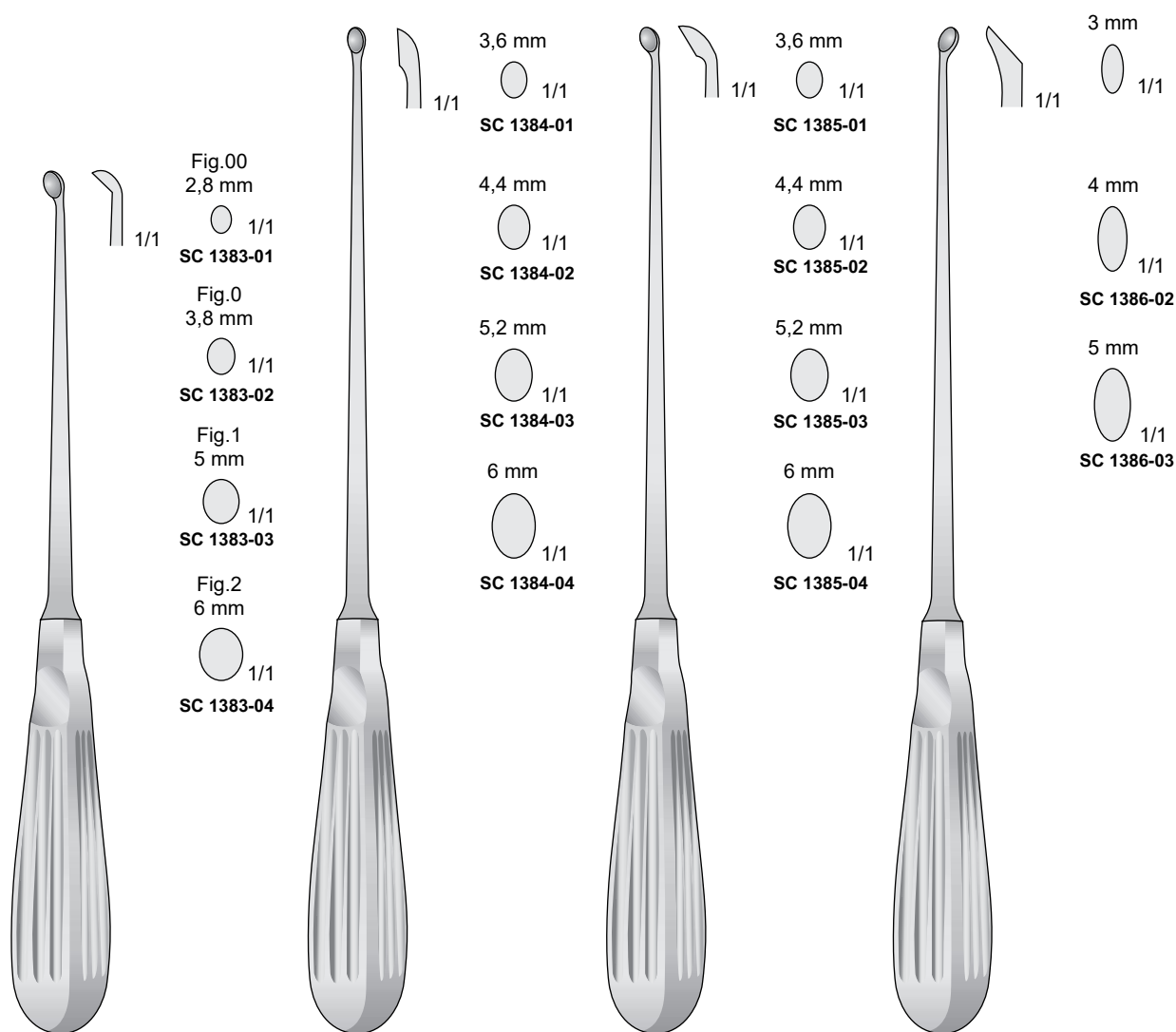

DAUBENSPECK

BUSHE

SC 1383-01 / SC 1383-04

SC 1384-01 / SC 1384-04

SC 1385-01 / SC 1385-04

SC 1386-01 / SC 1386-03

20 cm

25 cm

25 cm

25 cm

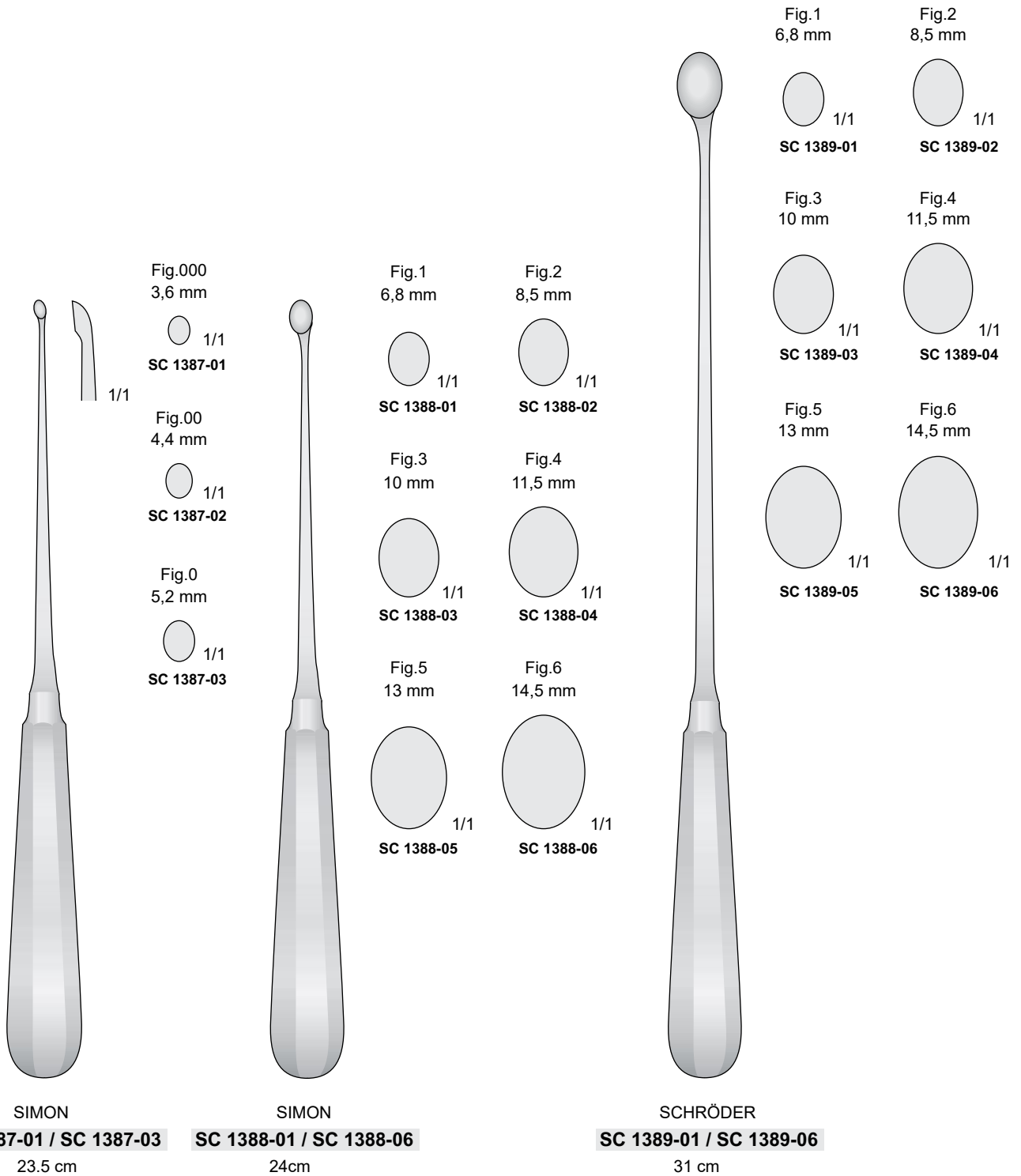

Curette, Cucchiari taglienti
 Sharp currettes
 Scharfe Löffel
 Curettes tranchante
 Cucharillas cortantes

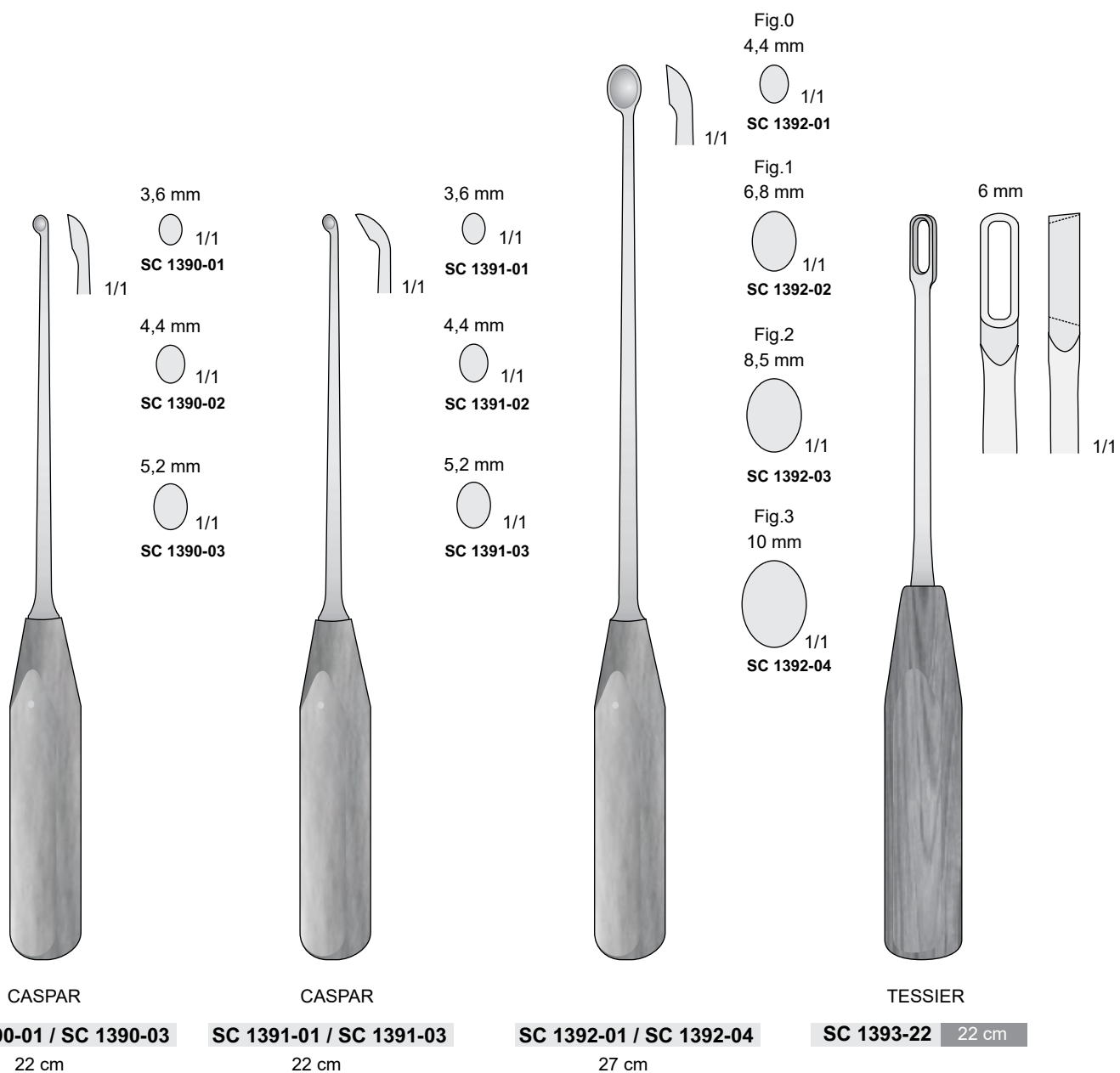

Strumentario per protesi femorale
Femoral prosthesis instrumentation
Instruments pour prothese femorale

Con manico Ferrozell
With Ferrozell handle
Mit Ferrozellgriff
Avec poignée en Ferrozell
Con mango de Ferrozell

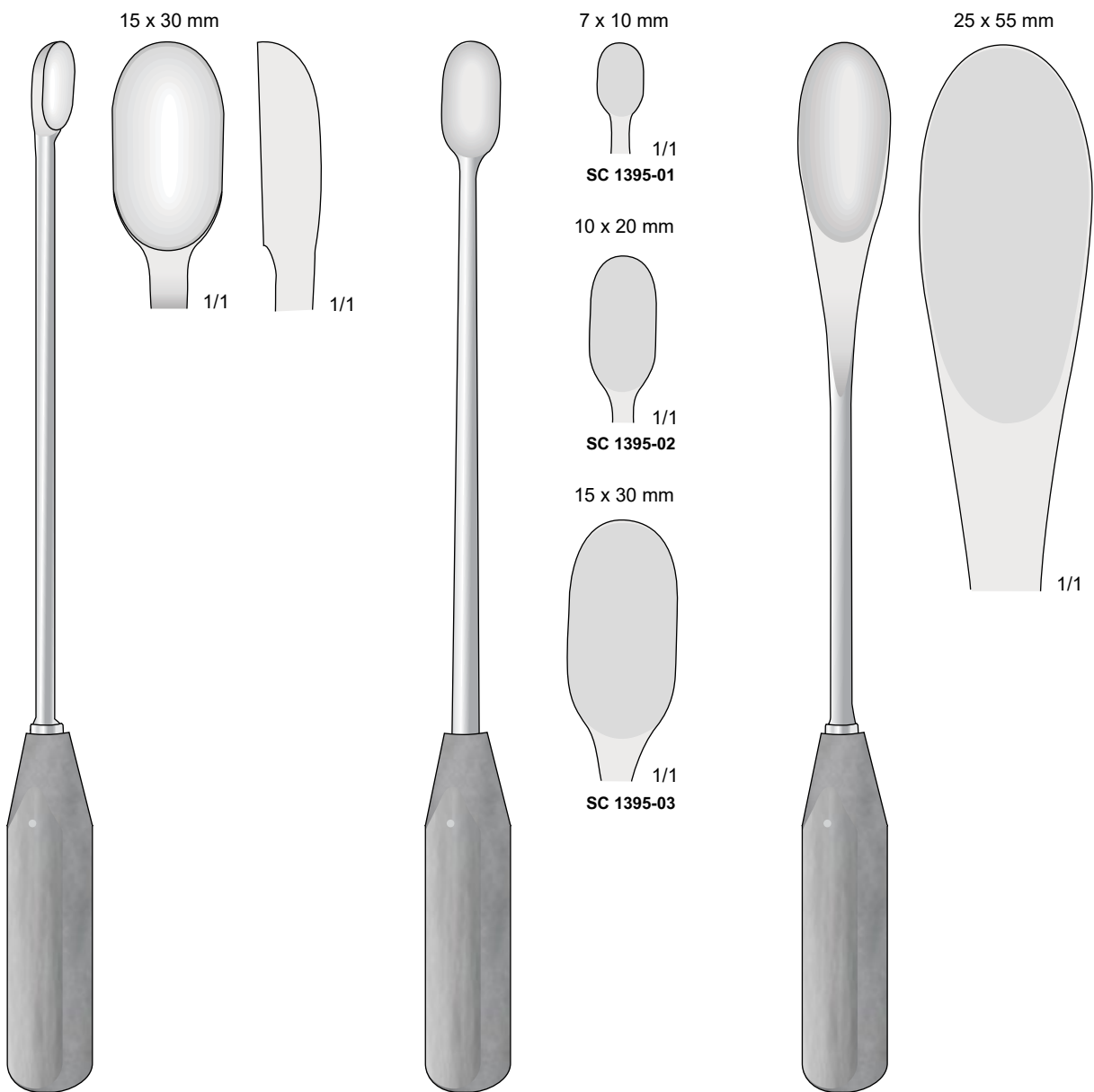

SC 1394-30 30 cm

SC 1395-01 / SC 1395-03

30 cm

SC 1396-30 30 cm



we take a closer look

Mallet ,Osteotome Bone Chisel



| Hämmer | Osteotom | Knochenmeißel
| Maillet | Ostéotome | Burin à os
| Martillo | Osteotomo | Cincel para hueso
| Martello | Osteotomo | Scalpello per osso

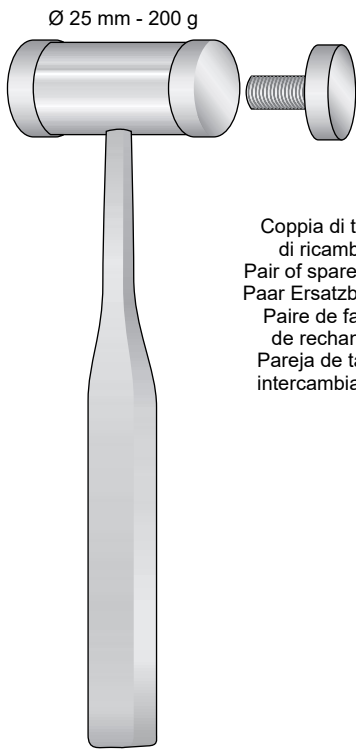

Coppia di teste
di ricambio
Pair of spare faces
Paar Ersatzbacken
Paire de faces
de rechange
Pareja de tapas
intercambiables

MEAD

SM 1400-20 20 cm

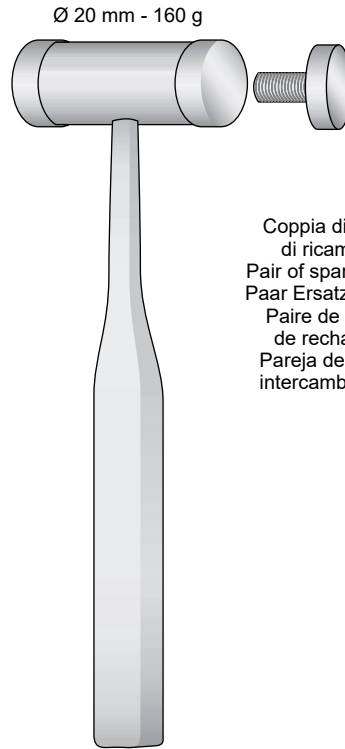

Coppia di teste
di ricambio
Pair of spare faces
Paar Ersatzbacken
Paire de faces
de rechange
Pareja de tapas
intercambiables

MEAD

SM 1401-19 19 cm

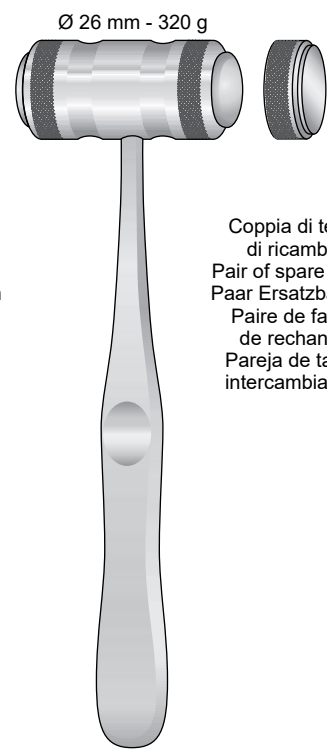

Coppia di teste
di ricambio
Pair of spare faces
Paar Ersatzbacken
Paire de faces
de rechange
Pareja de tapas
intercambiables

MEAD

SM 1402-19 19 cm

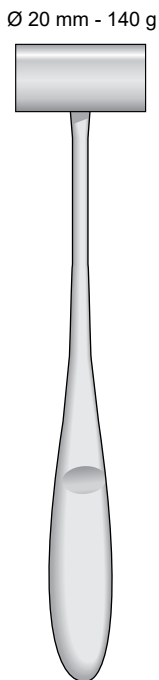

SM 1403-16 16.5 cm

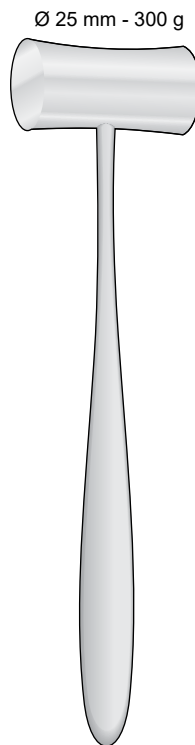

LUCAE

SM 1404-19 19 cm

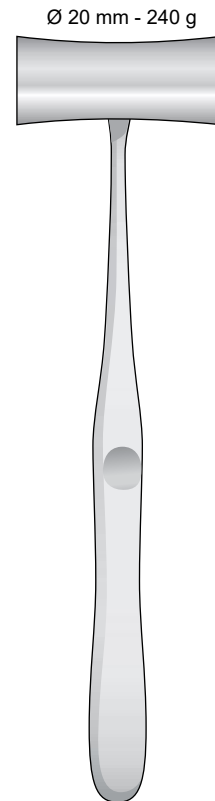

WILLIGER

SM 1405-24 24 cm

Martelli chirurgic
Surgical mallet
Chirurgische Hämme
Maillets chirurgicau
Martillos quirurgicos

1 Lato piatto - 1 Lato convesso
1 Side flat - 1 Side convex
1 Seite flach - 1 Seite convex
1 Face plate - 1 Face convexe
1 Parte plana - 1 Parte convexa

Ø 30 mm - 240 g

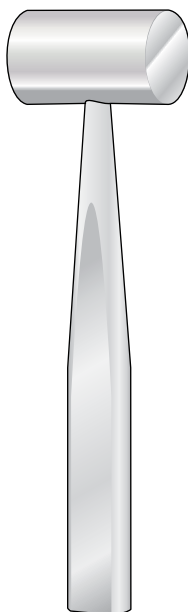

COTTLE

SM 1406-18 18.5 cm

Ø 30 mm - 300 g



BERGMANN

SM 1407-23 23.5 cm

Ø 45 mm - 300 g



BERGMANN

SM 1408-24 24.5 cm



SM 1409-24 24 cm

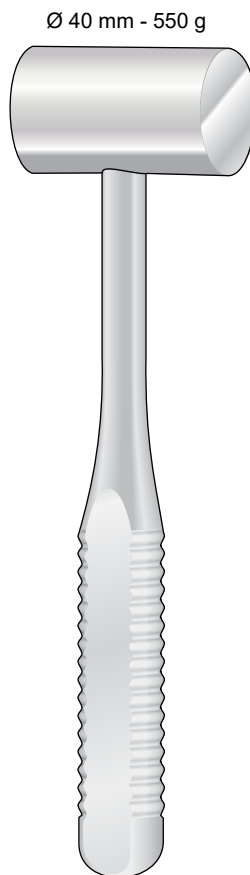

OMBREDANNE

SM 1410-24 24 cm



HEAT

SM 1411-18 18.5 cm

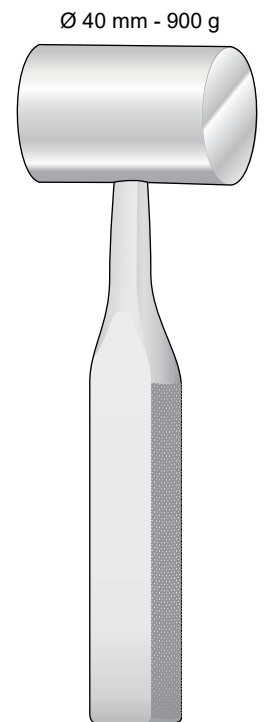

SM 1412-19 19 cm

Martelli chirurgic
Surgical mallet
Chirurgische Hämme
Maillets chirurgicau
Martillos quirurgicos

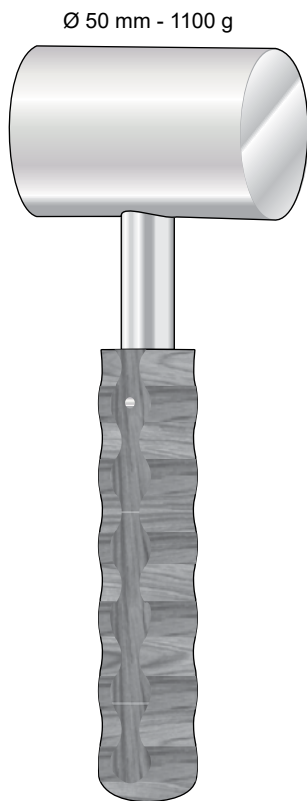

SM 1413-20 20 cm



SM 1414-26 26 cm

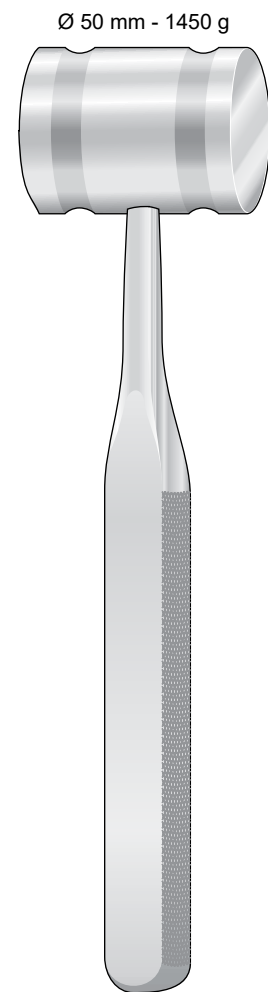

SM 1415-26 27 cm





-  O 1416-01
Ø3 mm
-  O 1416-02
Ø5 mm
-  O 1416-03
Ø8 mm

CASPAR

O 1416-01 / O 1416-03

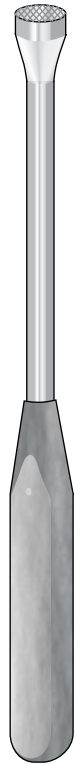
20 cm



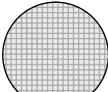
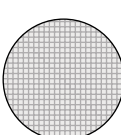



-  O 1417-01
Ø12 mm
-  O 1417-02
Ø14 mm
-  O 1417-03
Ø16 mm

O 1417-01 / O 1417-03

20 cm



-  O 1418-01
3x8 mm
-  O 1418-02
4x10 mm
-  O 1418-03
5x15 mm
-  O 1418-04
6x20 mm

SYPERT

O 1418-01 / O 1418-04

29 cm

Battitori - Osteotom
 Tampers - Osteotome
 Stossel - Osteotom
 Pilon - Ostéotome
 Batidor - Osteotomos

Ø 3 mm

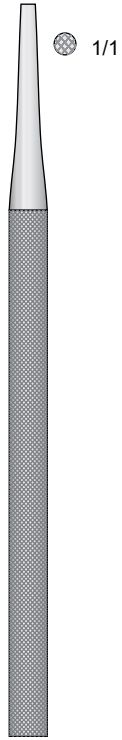

TO 1419-01
15.5 cm

Ø 5 mm

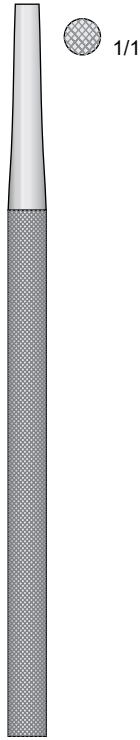

TO 1419-02
15.5 cm

Ø 7 mm

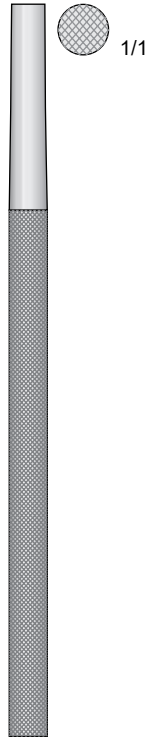

TO 1419-03
15.5 cm

Ø 2 mm

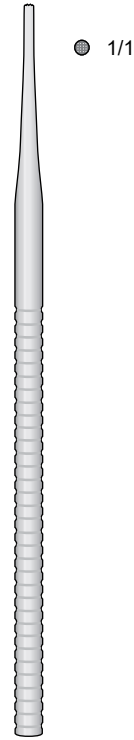

TO 1420-01
15.5 cm

Ø 4 mm

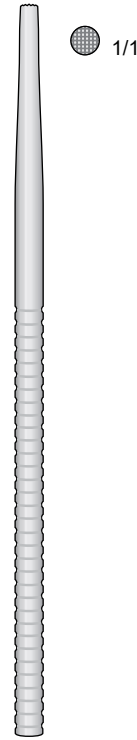

TO 1420-02
15.5 cm

Ø 3 mm

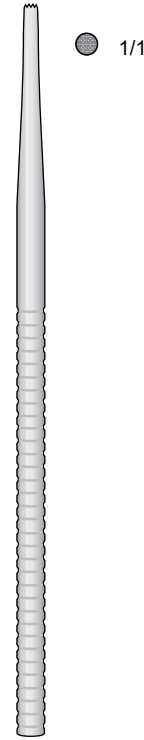

TO 1420-03
15.5 cm

Ø 5 mm

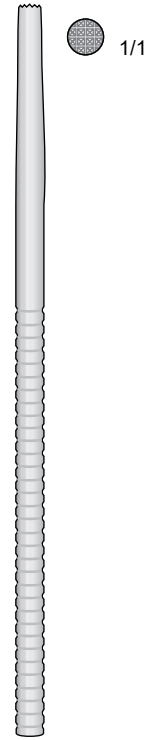

TO 1420-04
15.5 cm

2 mm

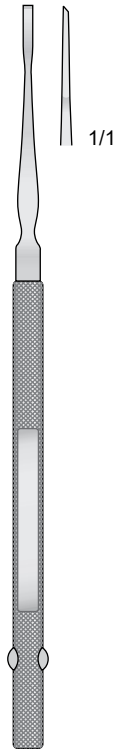

TO 1421-01
16 cm

4 mm

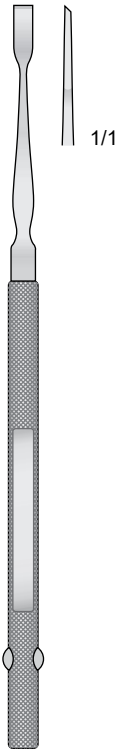

TO 1421-02
16 cm

6 mm

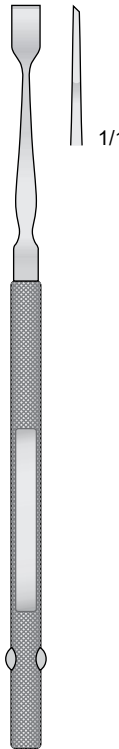

TO 1421-03
16 cm

2 mm

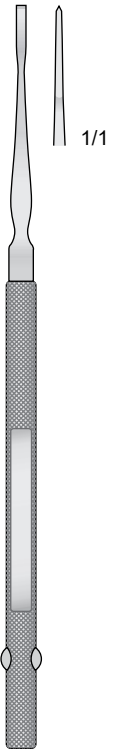

TO 1421-04
16 cm

4 mm

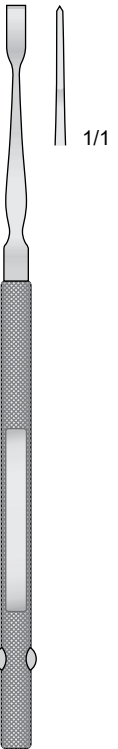

TO 1421-05
16 cm

6 mm

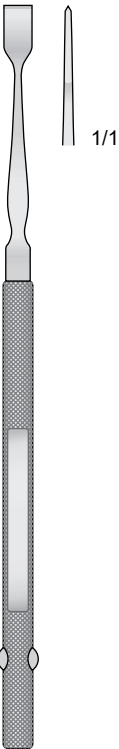

TO 1421-06
16 cm

4 mm

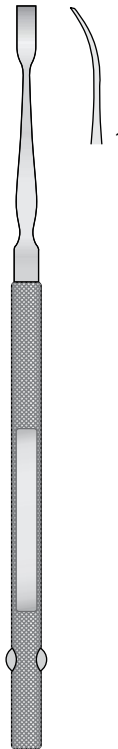

**FREER
TO 1421-07**
16 cm

4 mm

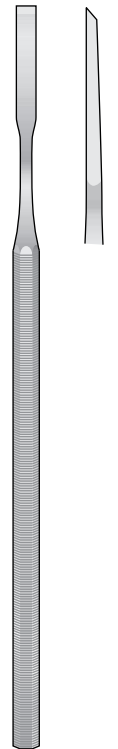

**BUCKLEY
TO 1422-01**
16 cm

4 mm

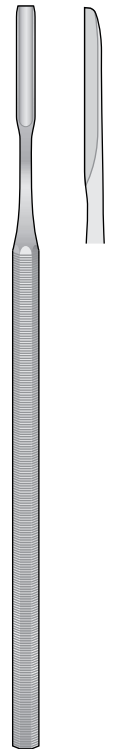

**BUCKLEY
TO 1422-02**
16 cm

Osteotomi - Osteotomes
 Osteotome - Ostéotomes - Osteótomos

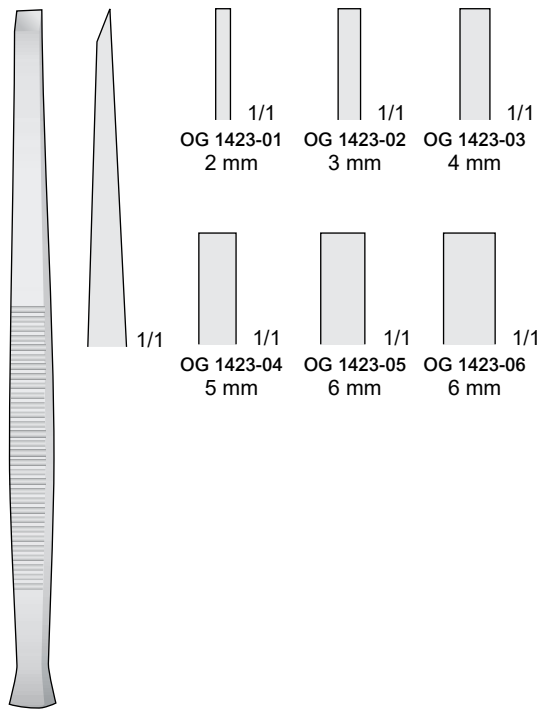

PARTSCH
OG 1423-01 / OG 1423-06
 14 cm

Sgorbie - Gouges
 Hohlmeissel - Gouges - Gubias

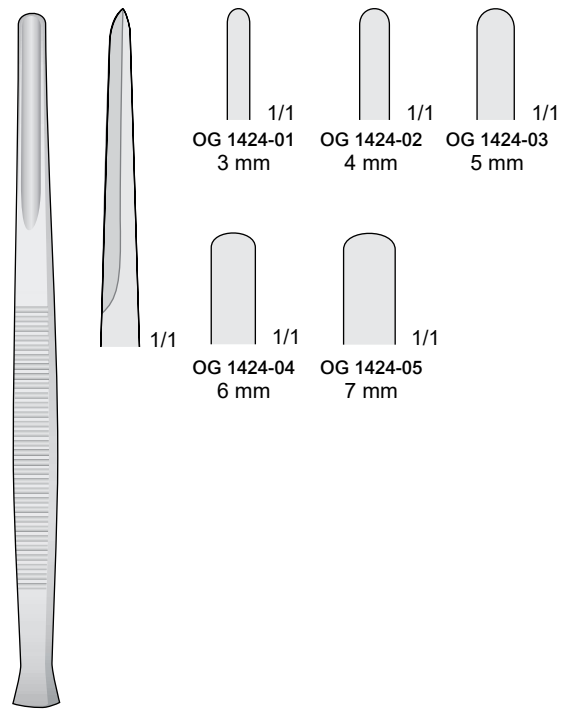

PARTSCH
OG 1424-01 / OG 1424-05
 14 cm

Osteotomi - Osteotomes
 Osteotome - Ostéotomes - Osteótomos

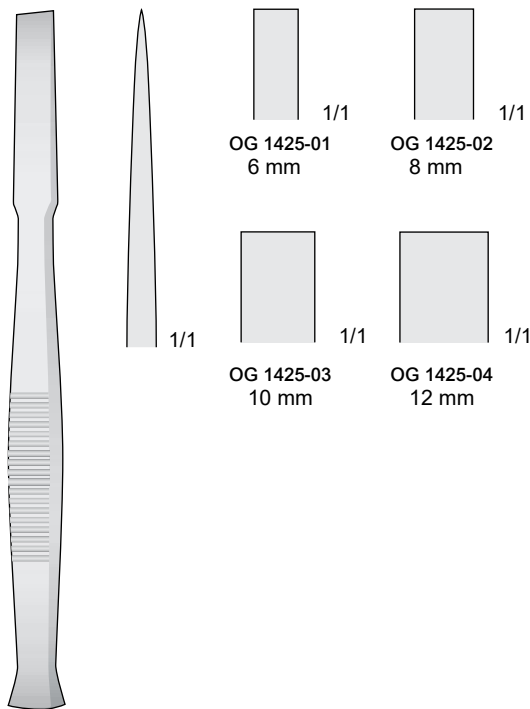

OG 1425-01 / OG 1425-04
 14 cm

Sgorbie - Gouges
 Hohlmeissel - Gouges - Gubias

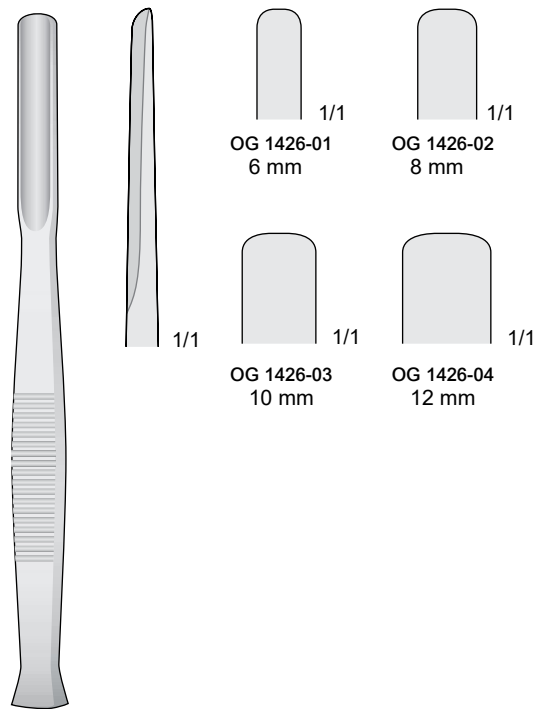

OG 1426-01 / OG 1426-04
 14 cm

Osteotomi - Scalpelli
 Osteotomes - Gouges
 Osteotome - Hohlmeissel
 Ostéotomes - Scalpel
 Osteótomos - Cinceles

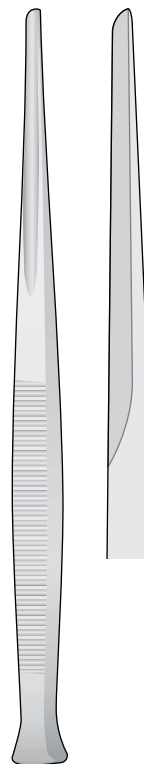
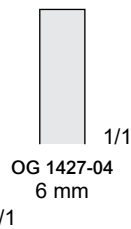
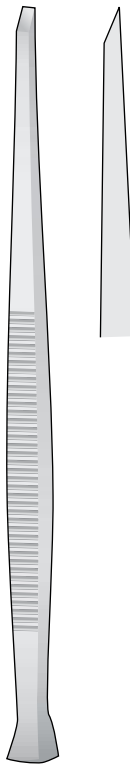
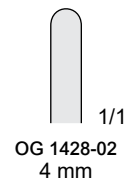
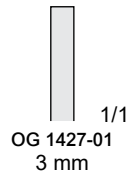

PARTSCH
OG 1427-01 / OG 1427-05
 17 cm

PARTSCH
OG 1428-01 / OG 1428-05
 17 cm

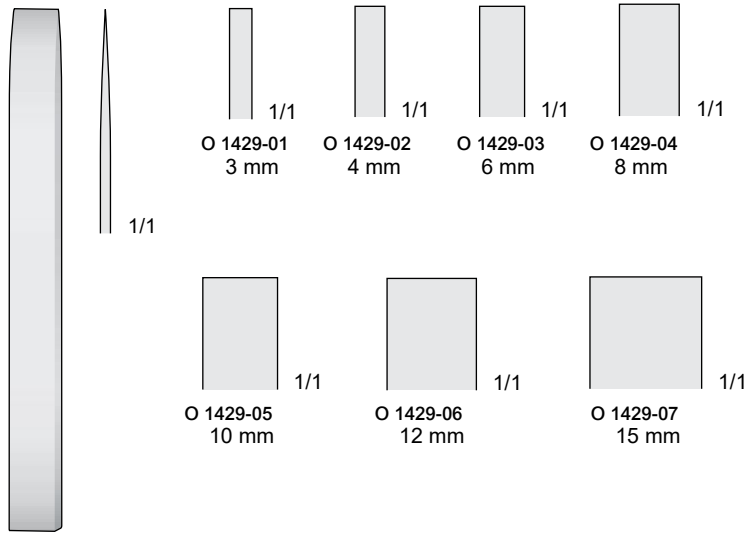

MINI-LAMBOTTE

O 1429-01 / O 1429-07

12.5 cm

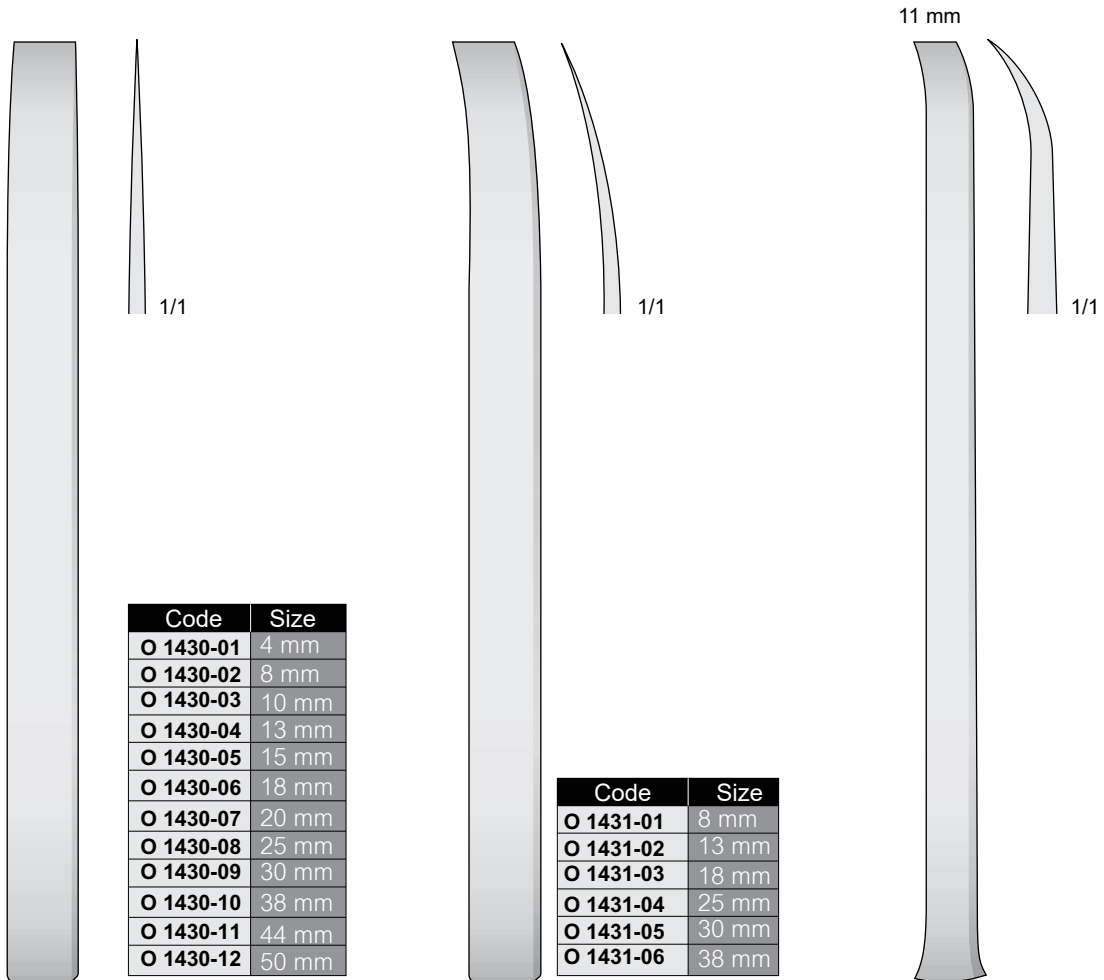

Code	Size
O 1430-01	4 mm
O 1430-02	8 mm
O 1430-03	10 mm
O 1430-04	13 mm
O 1430-05	15 mm
O 1430-06	18 mm
O 1430-07	20 mm
O 1430-08	25 mm
O 1430-09	30 mm
O 1430-10	38 mm
O 1430-11	44 mm
O 1430-12	50 mm

Code	Size
O 1431-01	8 mm
O 1431-02	13 mm
O 1431-03	18 mm
O 1431-04	25 mm
O 1431-05	30 mm
O 1431-06	38 mm

LAMBOTTE

O 1430-01 / O 1430-12

25 cm

LAMBOTTE

O 1431-01 / O 1431-06

25 cm

OBWEGESER

O 1432-23 23 cm

Osteotomi
 Osteotomes
 Osteotome
 Ostéotomes
 Osteõtomas

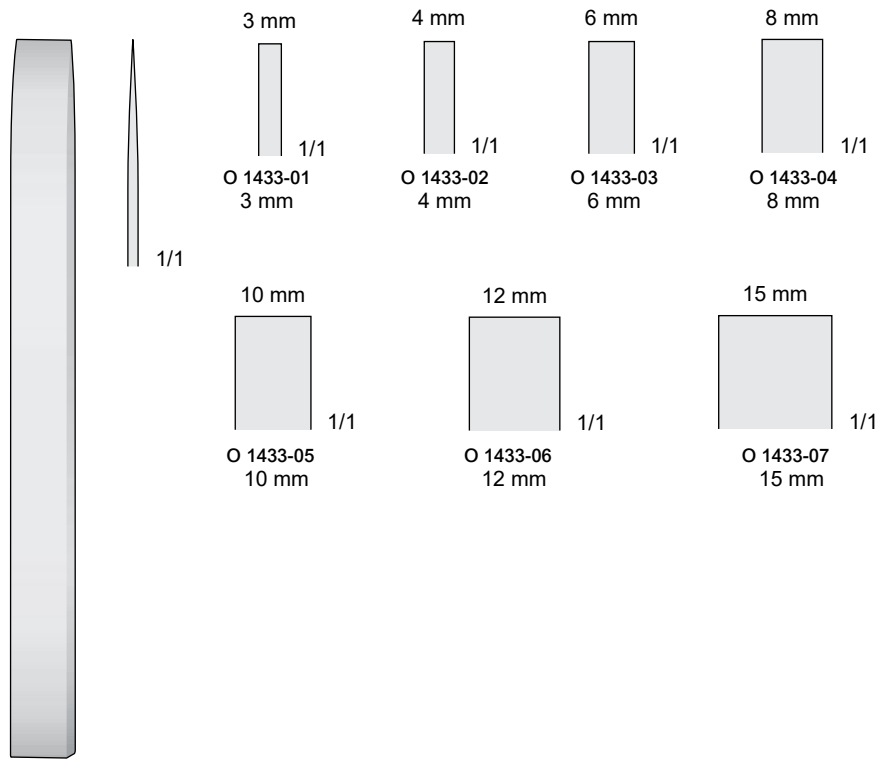

MINI-LAMBOTTE

O 1433-01 / O 1433-07

17 cm

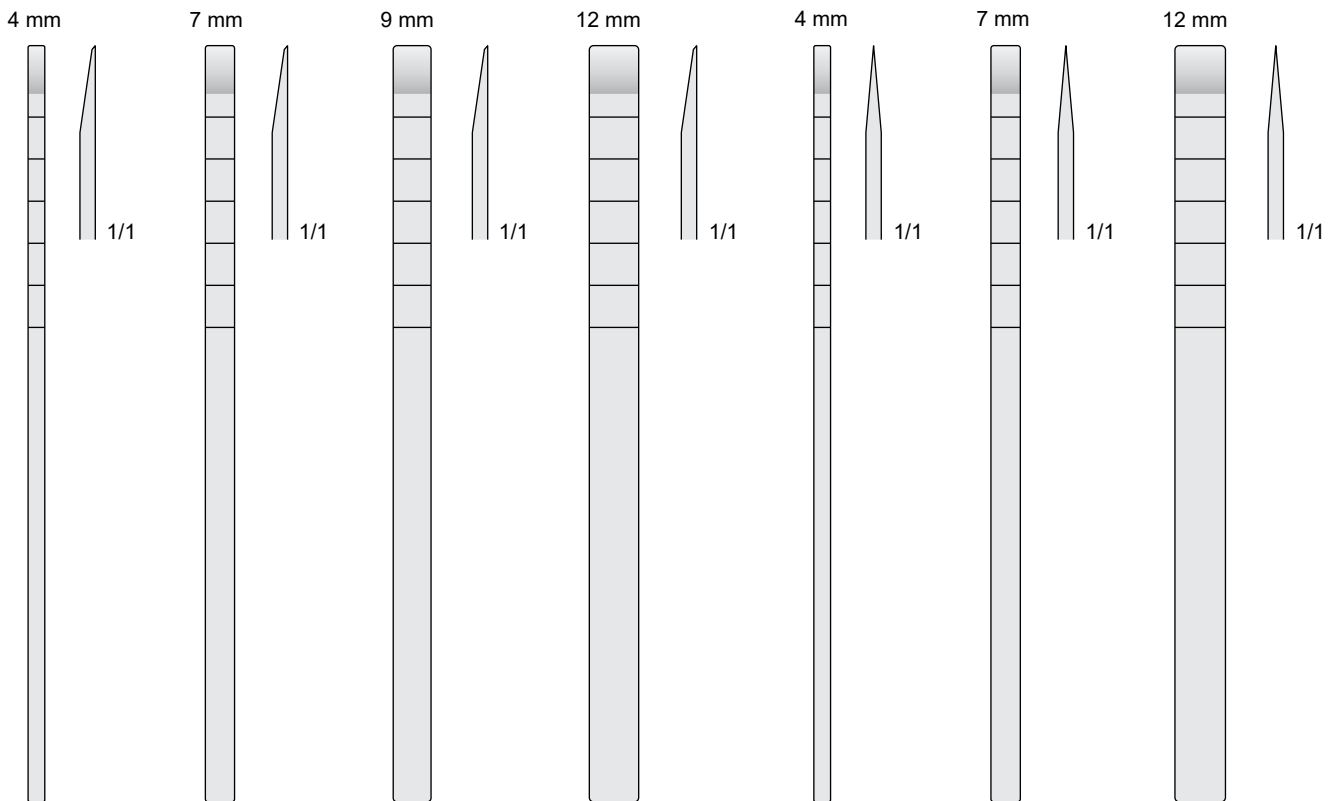

COTTLE
 O 1434-01
 18 cm

COTTLE
 O 1434-02
 18 cm

COTTLE
 O 1434-03
 18 cm

COTTLE
 O 1434-04
 18 cm

COTTLE
 O 1434-05
 18 cm

COTTLE
 O 1434-06
 18 cm

COTTLE
 O 1434-07
 18 cm



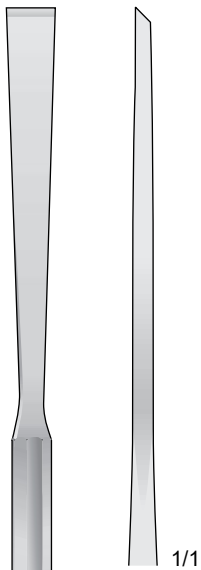

Code	Size
O 1435-01	6,4 mm
O 1435-02	13 mm
O 1435-03	19 mm

HIBBS
O 1435-01 / O 1435-03
23 cm

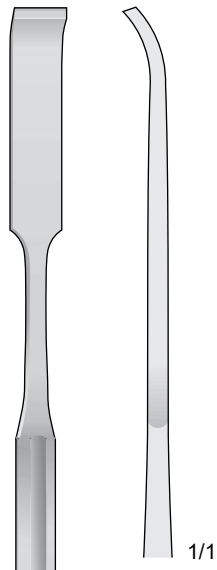

Code	Size
O 1436-01	6,4 mm
O 1436-02	13 mm
O 1436-03	19 mm

HIBBS
O 1436-01 / O 1436-03
23 cm

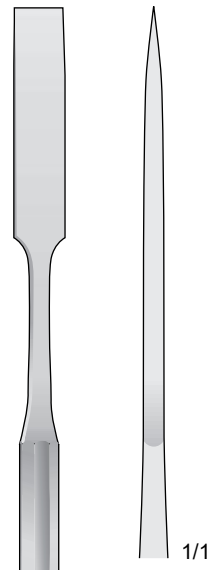

Code	Size
O 1437-01	6,4 mm
O 1437-02	13 mm
O 1437-03	19 mm

HIBBS
O 1437-01 / O 1437-03
23 cm

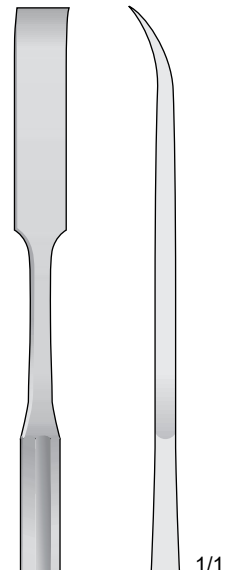

Code	Size
O 1438-01	6,4 mm
O 1438-02	13 mm
O 1438-03	19 mm

HIBBS
O 1438-01 / O 1438-03
23 cm

Osteotomi
 Osteotomes
 Osteotome
 Ostéotomes
 Osteòtomos



Code	Size
O 1439-01	4 mm
O 1439-02	6 mm
O 1439-03	8 mm

O 1439-01 / O 1439-03
 18 cm



Code	Size
O 1440-01	4 mm
O 1440-02	6 mm
O 1440-03	8 mm





O 1440-01 / O 1440-03
 18 cm

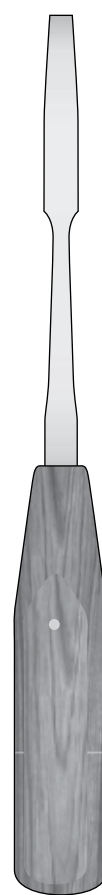

Code	Size
O 1441-01	6 mm
O 1441-02	8 mm

O 1441-01 / O 1441-02
 18 cm



 1/1	O 1442-01	2 mm
 1/1	O 1442-02	4 mm
 1/1	O 1442-03	6 mm
 1/1	O 1442-04	8 mm

MINI-LEXER
O 1442-01 / O 1442-04
 20 cm

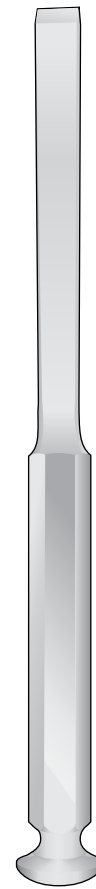
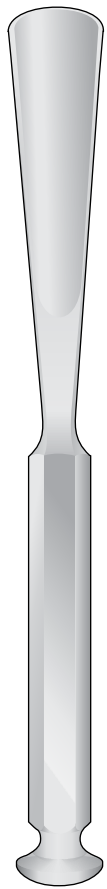
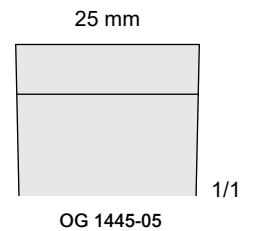
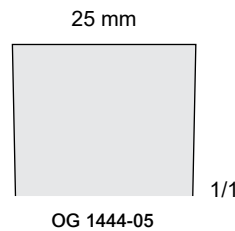
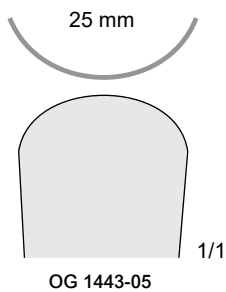
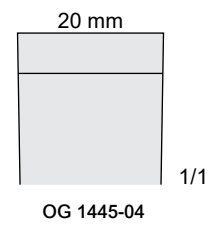
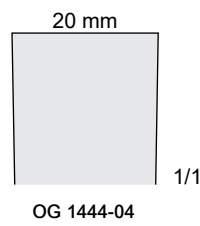
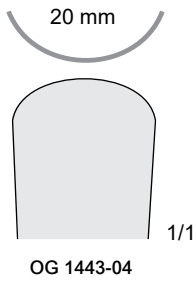
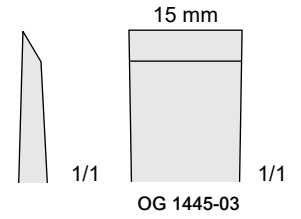
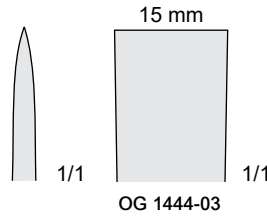
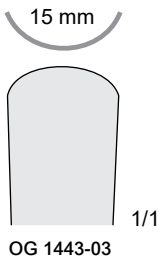
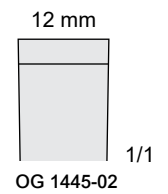
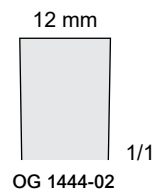
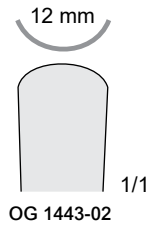
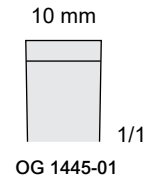
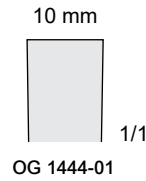
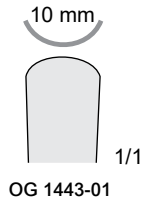

STILLE
OG 1443-01 / OG 1443-05
20 cm

STILLE
OG 1444-01 / OG 1444-05
20 cm

STILLE
OG 1445-01 / OG 1445-05
20 cm

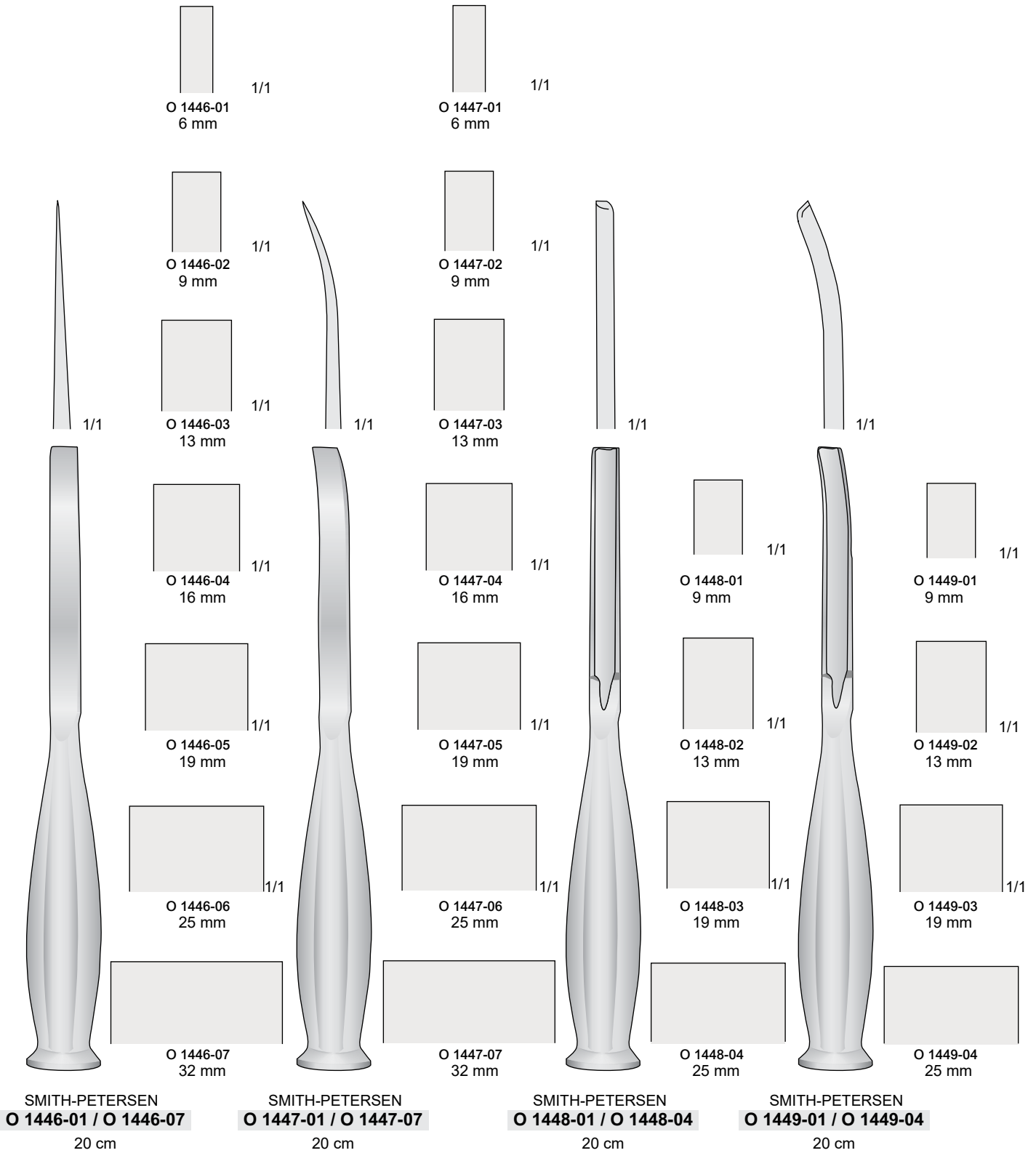

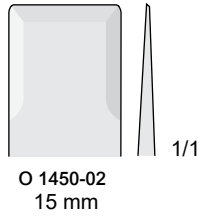
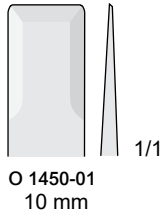
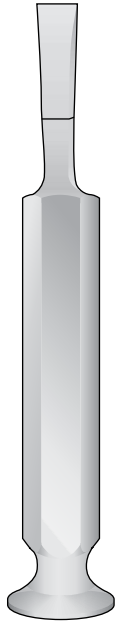

TESSIER
O 1450-01 / O 1450-02
16 cm

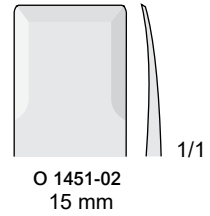
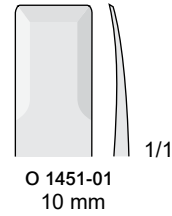
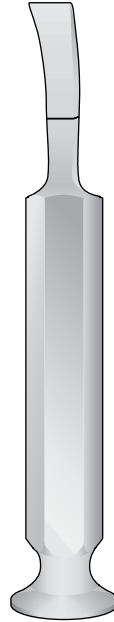

TESSIER
O 1451-01 / O 1451-02
16 cm

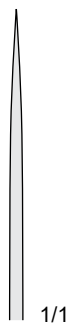
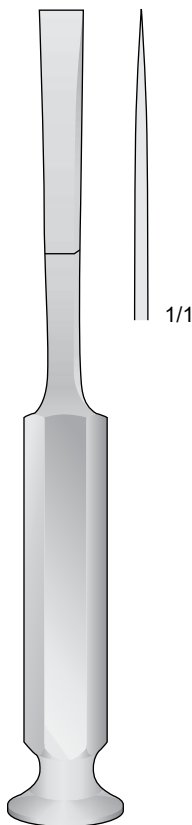

Code	Size
O 1452-01	10 mm
O 1452-02	15 mm
O 1452-03	20 mm
O 1452-04	30 mm

TESSIER
O 1452-01 / O 1452-04
20 cm

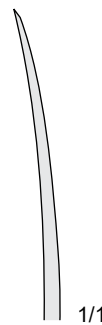
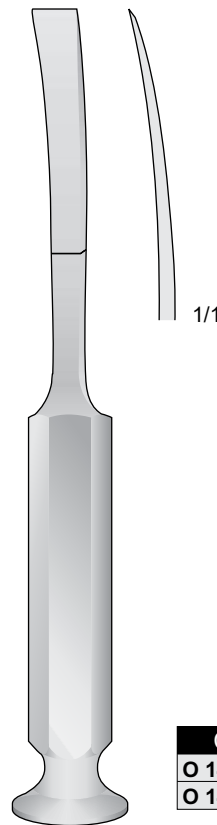

Code	Size
O 1453-01	10 mm
O 1453-02	15 mm

TESSIER
O 1453-01 / O 1453-02
20 cm

Set completo di Set complete with Komplettsset mit Set complet avec Set completo con		
1 Manico portalamo in ferrozell	4 Lame Fig. 1-2-3-4	1 Chiave ferma lama
1 With Ferrozell handle	4 Blades Fig. 1-2-3-4	-
1 Mit Ferrozellgriff	4 Klingen Fig. 1-2-3-4	-
1 Avec poignée en Ferrozell	4 Lames Fig. 1-2-3-4	-
1 Con mango de Ferrozell	4 Hojas Fig. 1-2-3-4	-

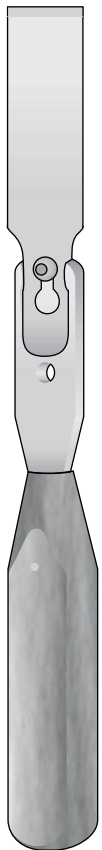

O 1455-19 19 cm

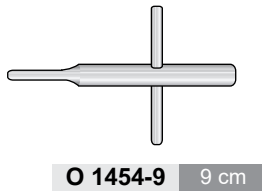

O 1454-9 9 cm

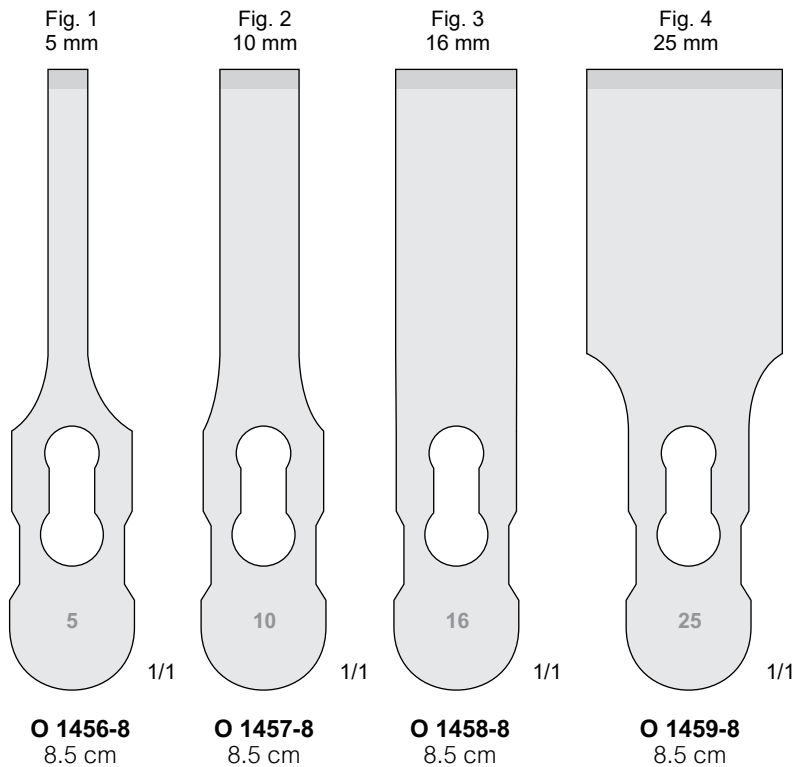

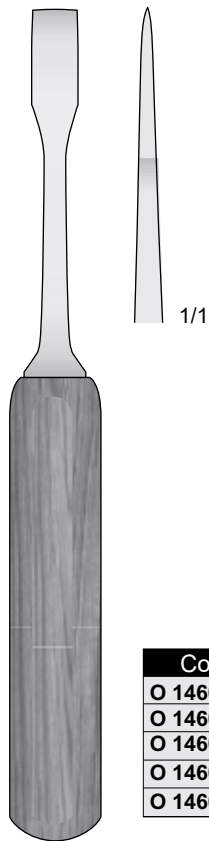

Code	Size
O 1460-01	4 mm
O 1460-02	6 mm
O 1460-03	8 mm
O 1460-04	10 mm
O 1460-05	12 mm

MINI-LEXER
O 1460-01 / O 1460-05
18 cm



Code	Size
O 1461-01	4 mm
O 1461-02	6 mm
O 1461-03	8 mm
O 1461-04	10 mm
O 1461-05	12 mm

MINI-LEXER
O 1461-01 / O 1461-05
18 cm

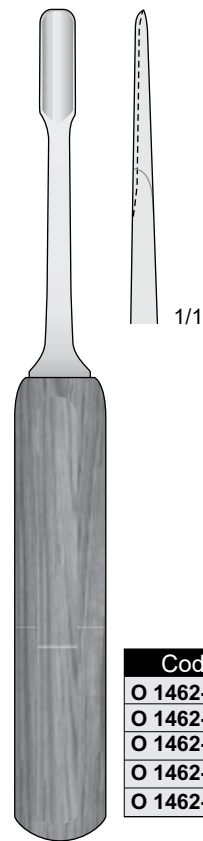

Code	Size
O 1462-01	4 mm
O 1462-02	6 mm
O 1462-03	8 mm
O 1462-04	10 mm
O 1462-05	12 mm

LEXER
O 1462-01 / O 1462-05
18 cm

Osteotomi
 Osteotomes
 Osteotome
 Ostéotomes
 Osteõtomos

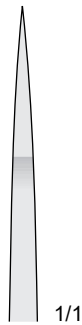

1/1

Code	Size
O 1463-01	5 mm
O 1463-02	7 mm
O 1463-03	10 mm
O 1463-04	15 mm
O 1463-05	20 mm
O 1463-06	25 mm
O 1463-07	30 mm

LEXER

O 1463-01 / O 1463-07
 22 cm

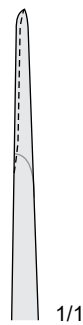
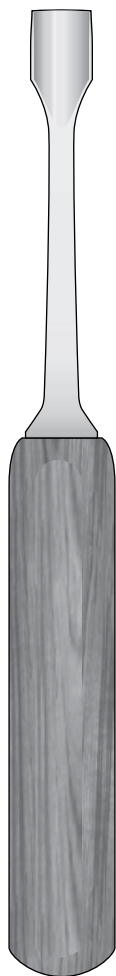

1/1

Code	Size
O 1464-01	5 mm
O 1464-02	7 mm
O 1464-03	10 mm
O 1464-04	15 mm
O 1464-05	20 mm
O 1464-06	25 mm
O 1464-07	30 mm

LEXER

O 1464-01 / O 1464-07
 22 cm

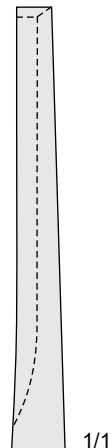
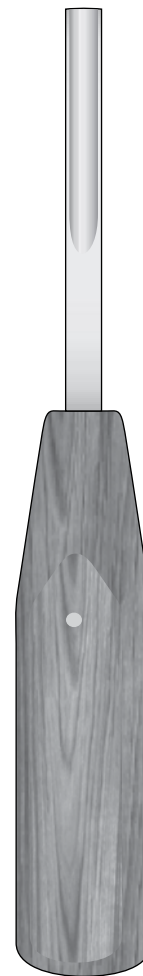

1/1

9 mm

O 1465-22 22 cm



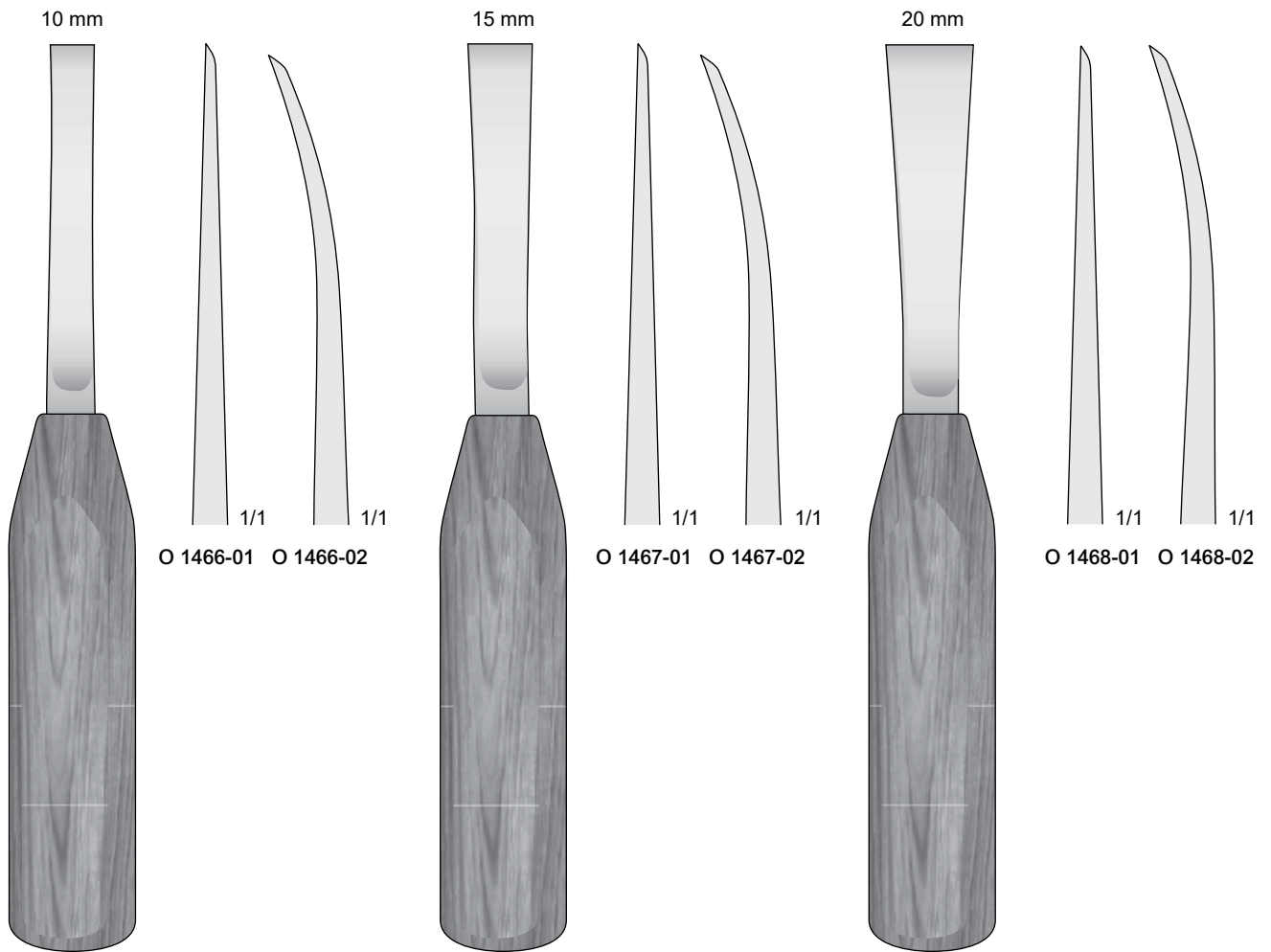

O 1466-01 / O 1466-02
20 cm

O 1467-01 / O 1467-02
20 cm

O 1468-01 / O 1468-02
20 cm

Osteotomi
 Osteotomes
 Osteotome
 Ostéotomes
 Osteòtomos

Sgorbie - Gouges
 Hohlmeissel - Gouges - Gubias

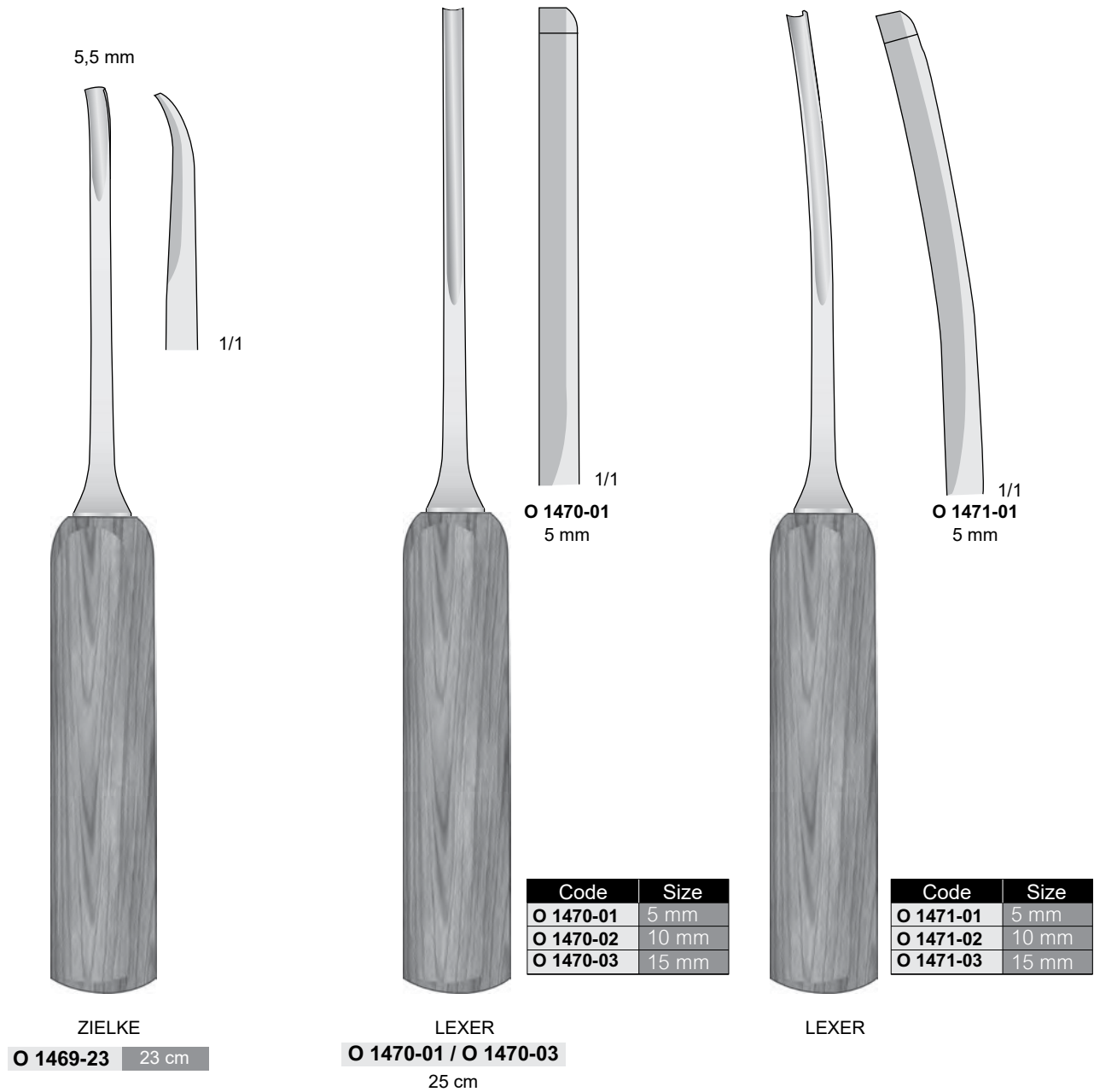

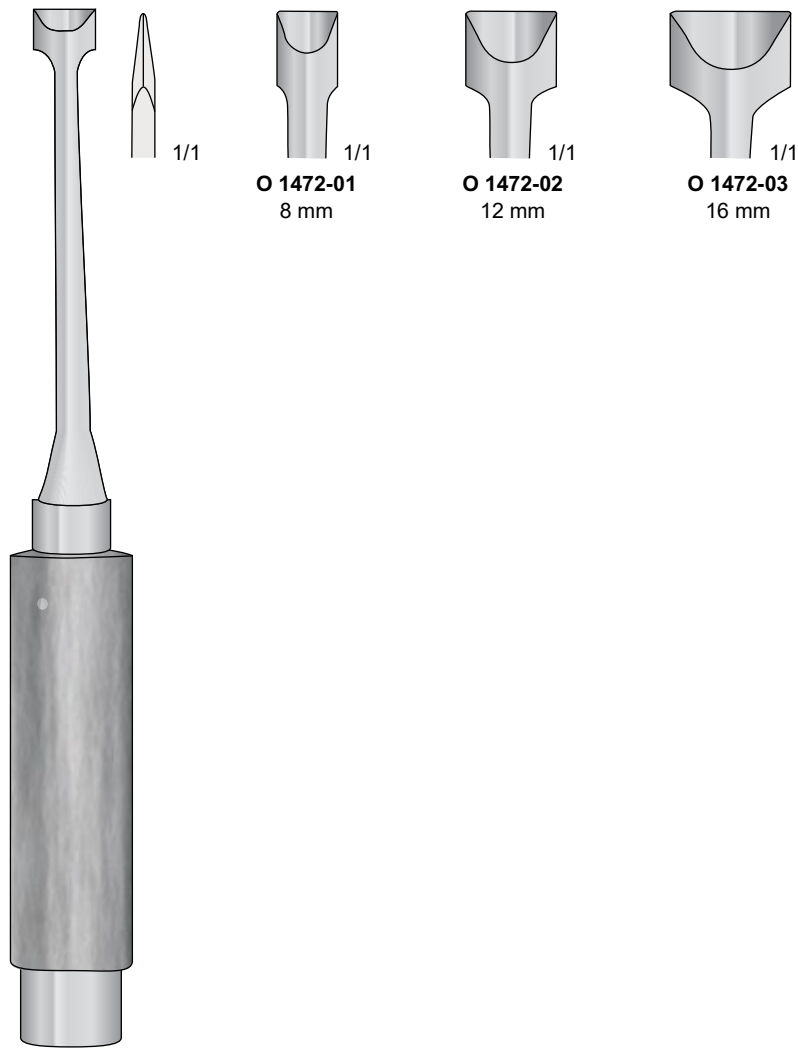

OBWEGESER
O 1472-01 / O 1472-03
22 cm

Osteotomi
Osteotomes
Osteotome
Ostéotomes
Osteòtomos

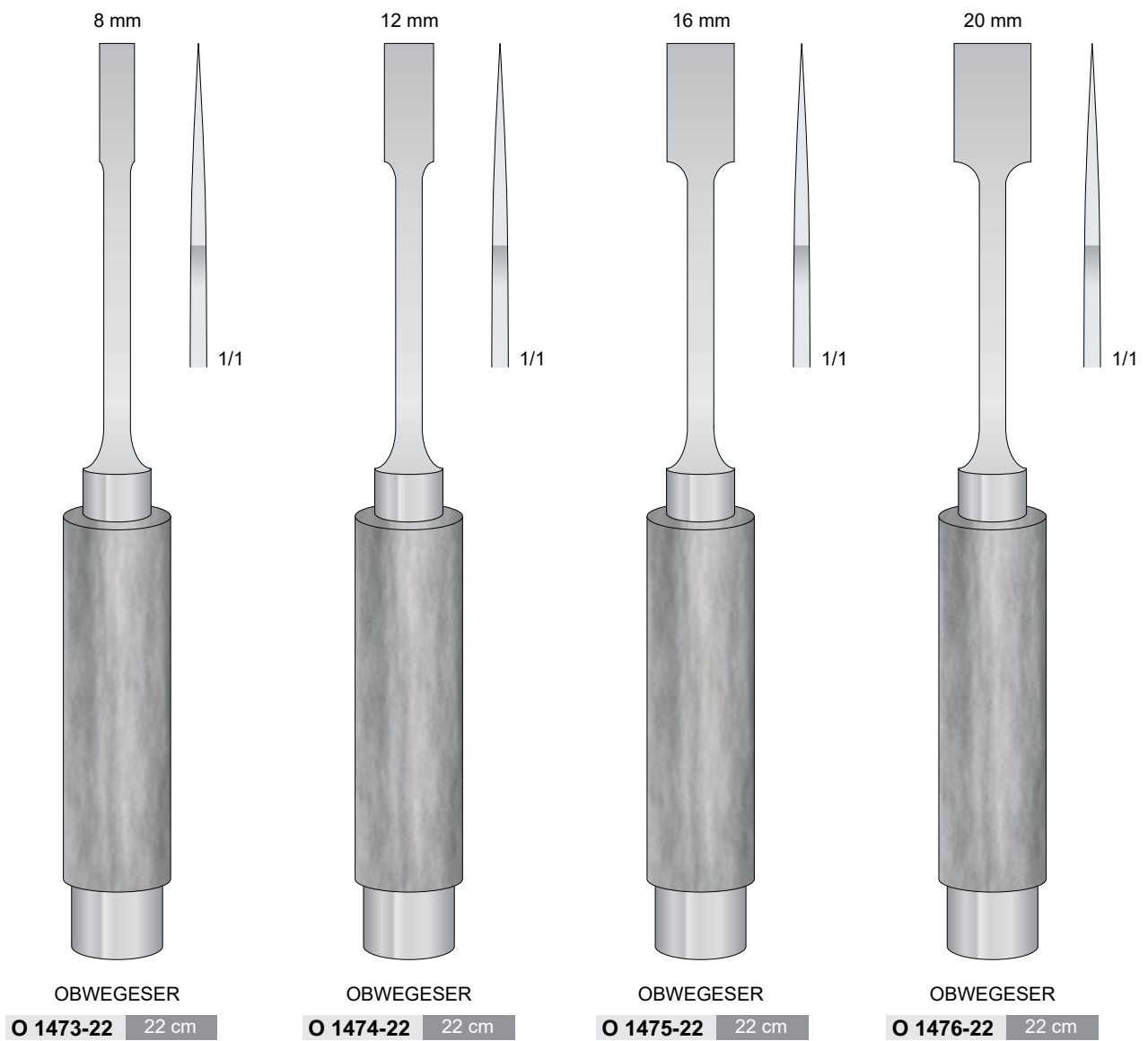



we take a closer look

+ Bone surgery Laminectomy

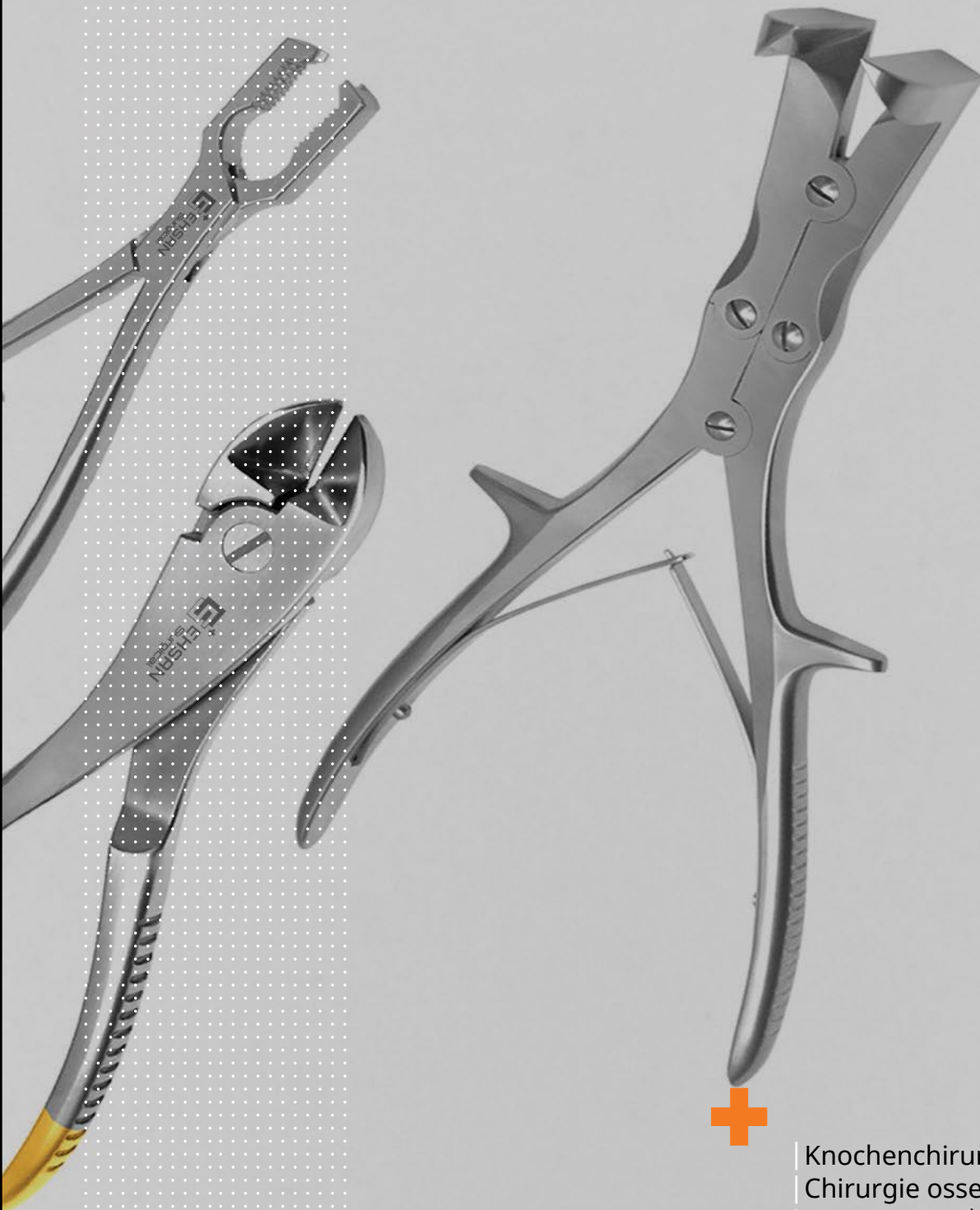

Knochenchirurgie | Laminektomie
Chirurgie osseuse | Laminectomia
Cirugía ósea | Laminectomía
Chirurgia ossea | Laminectomia

Pinze ossivor
Bone cutting forcep
Knochensplitterzange
Pincès à o
Pinza cortantes para huesos

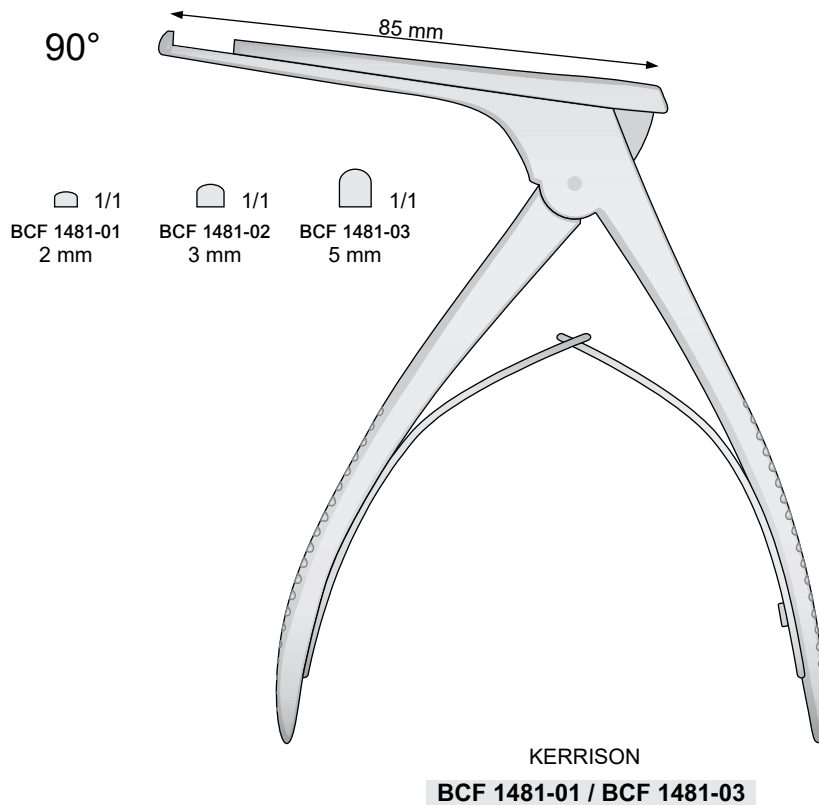
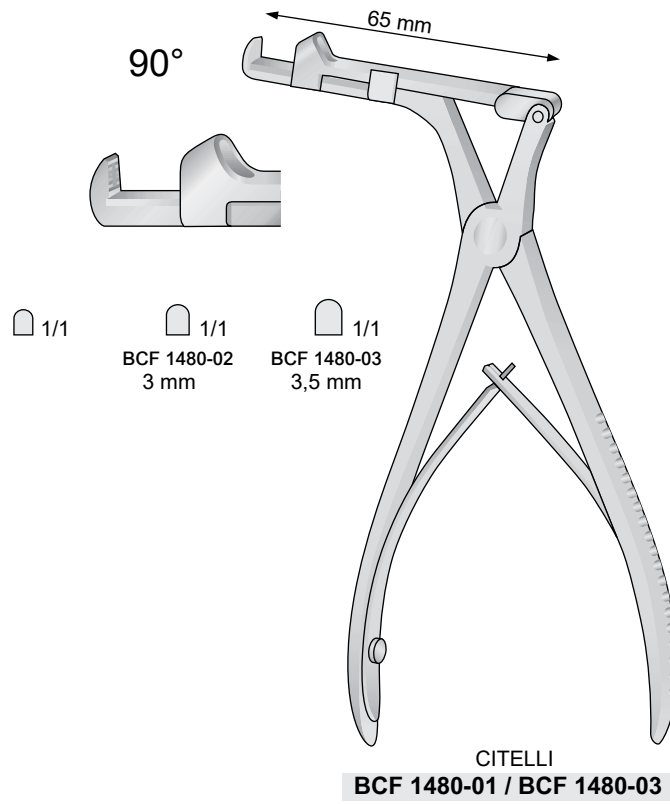

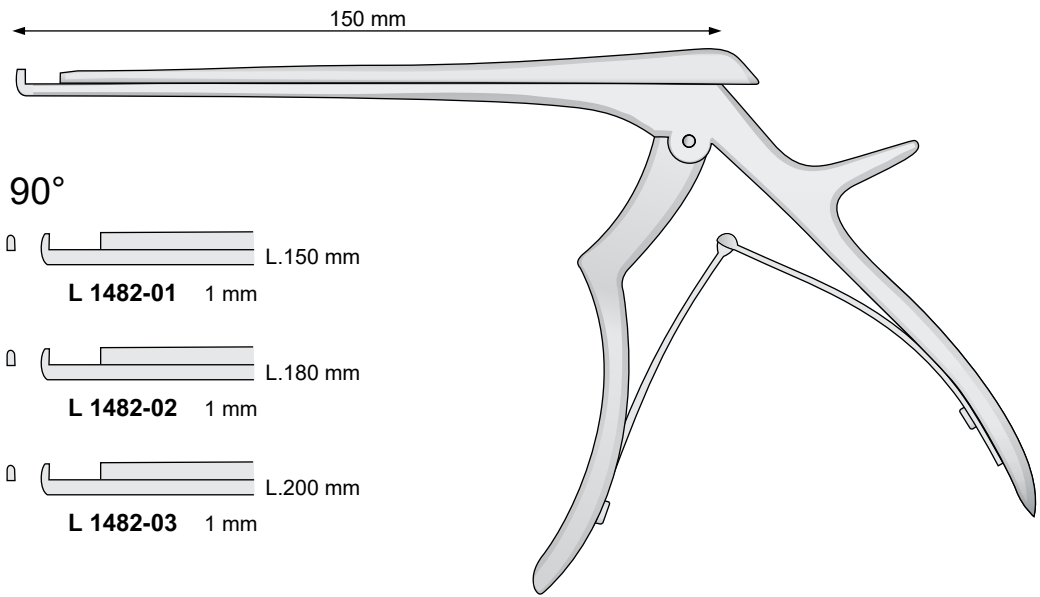

FERRIS-SMITH-KERRISON
L 1482-01 / L 1482-03

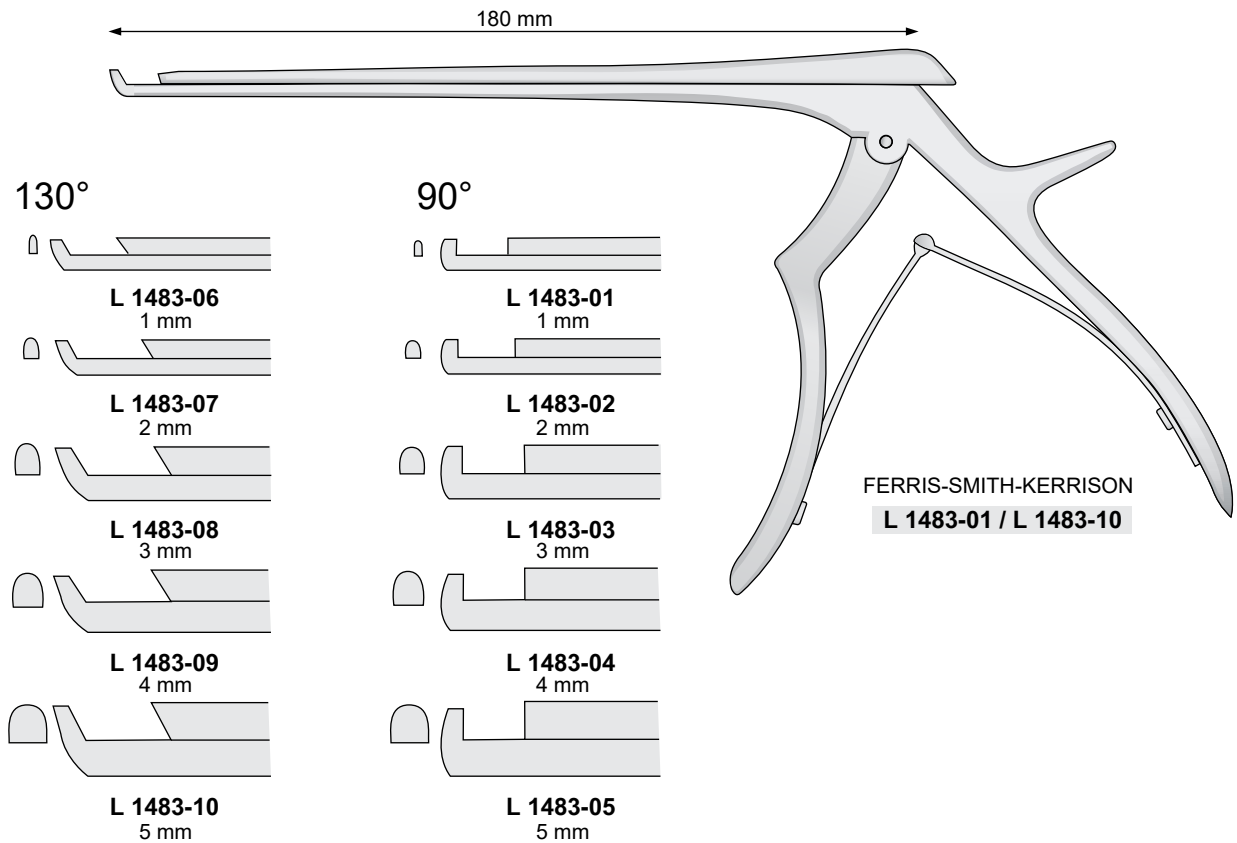

FERRIS-SMITH-KERRISON
L 1483-01 / L 1483-10

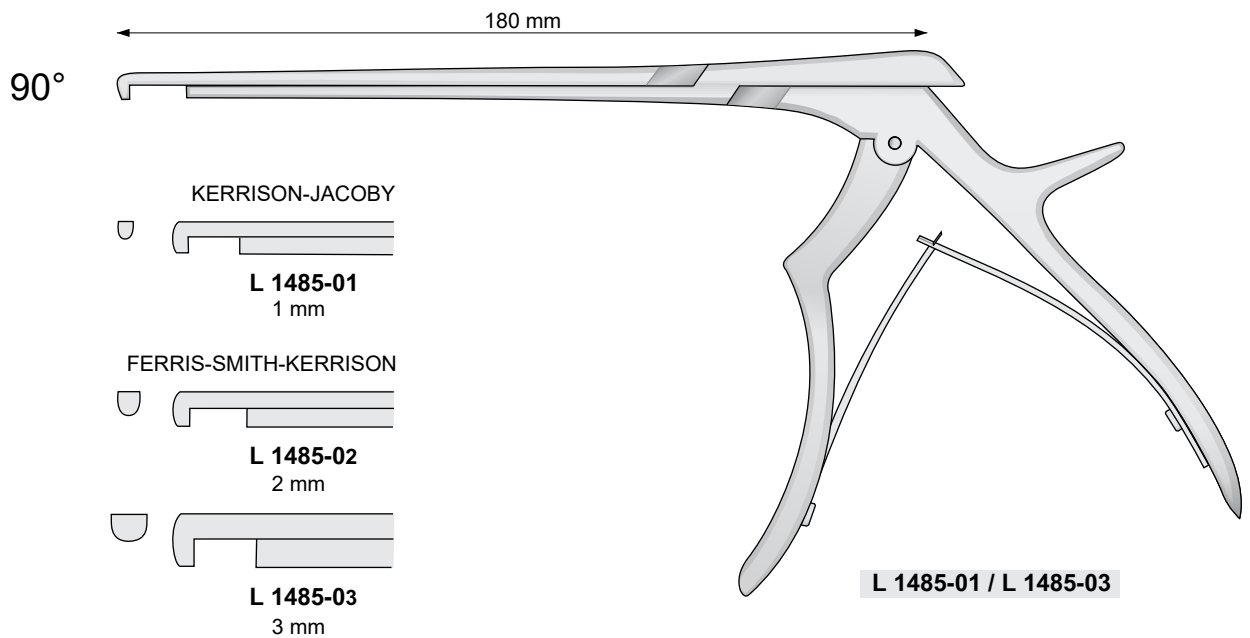
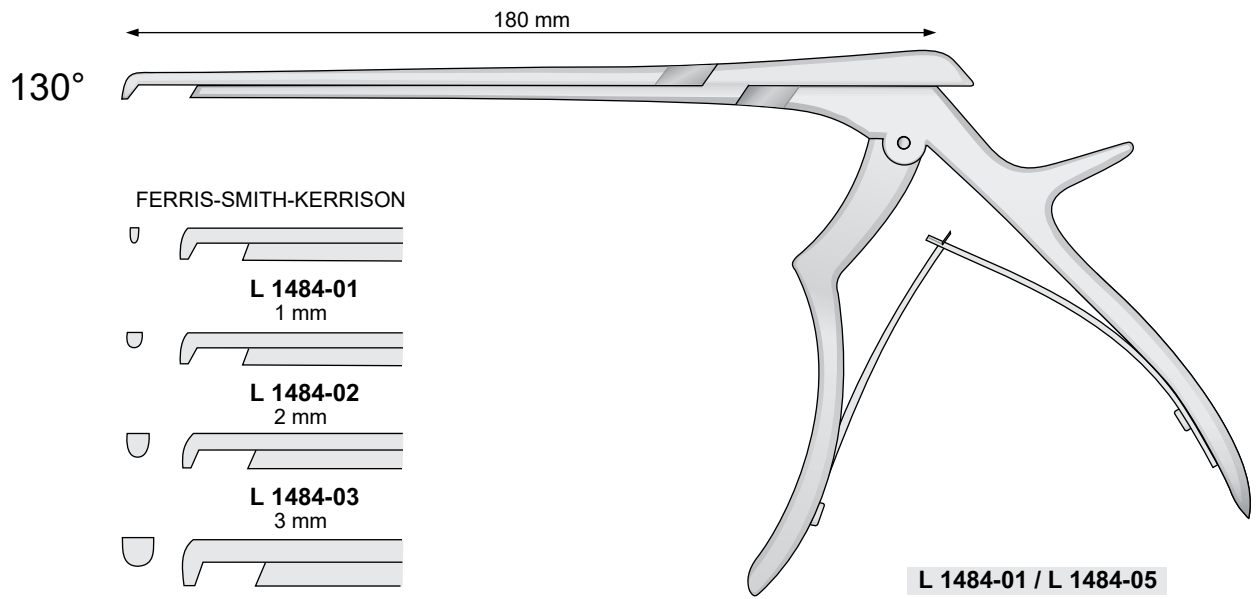

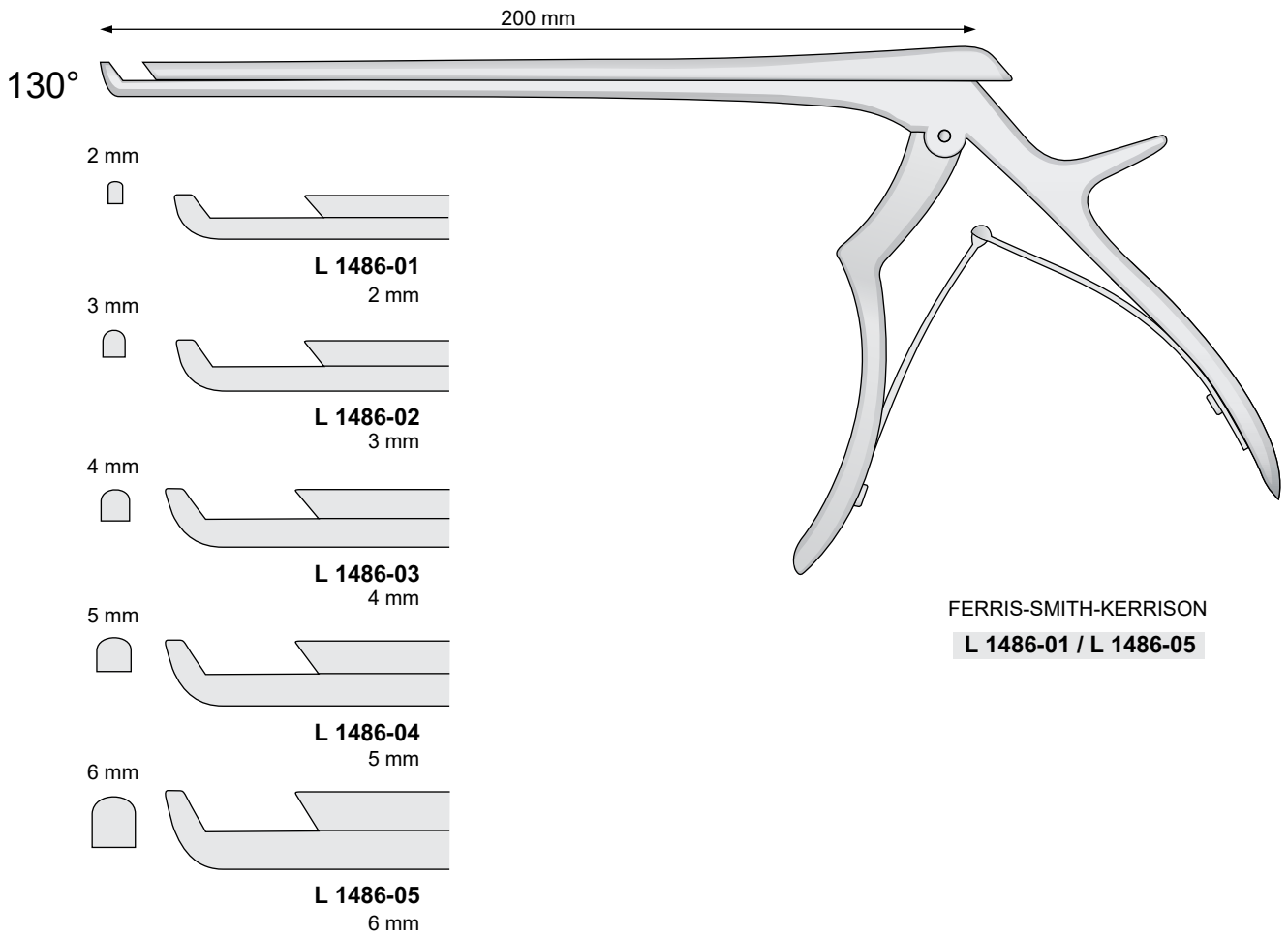

Laminotomo cervicale - Cervical Laminectomy

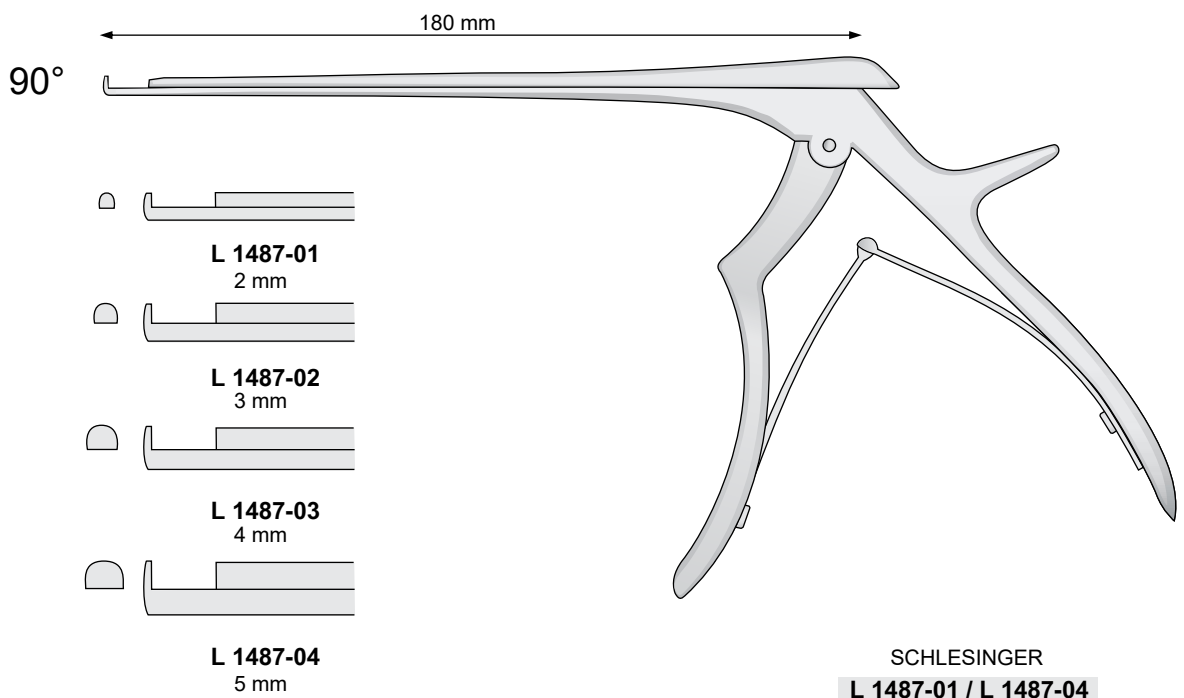

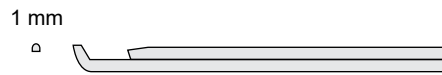

L 1488-01
1 mm

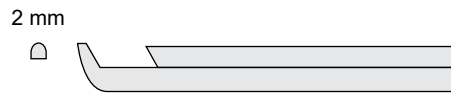

L 1488-02
2 mm

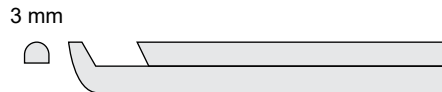

L 1488-03
3 mm

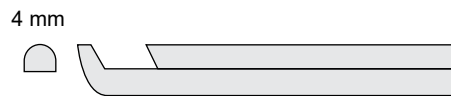

L 1488-04
4 mm

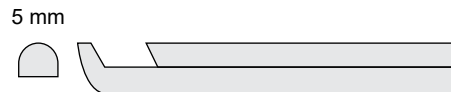

L 1488-05
5 mm

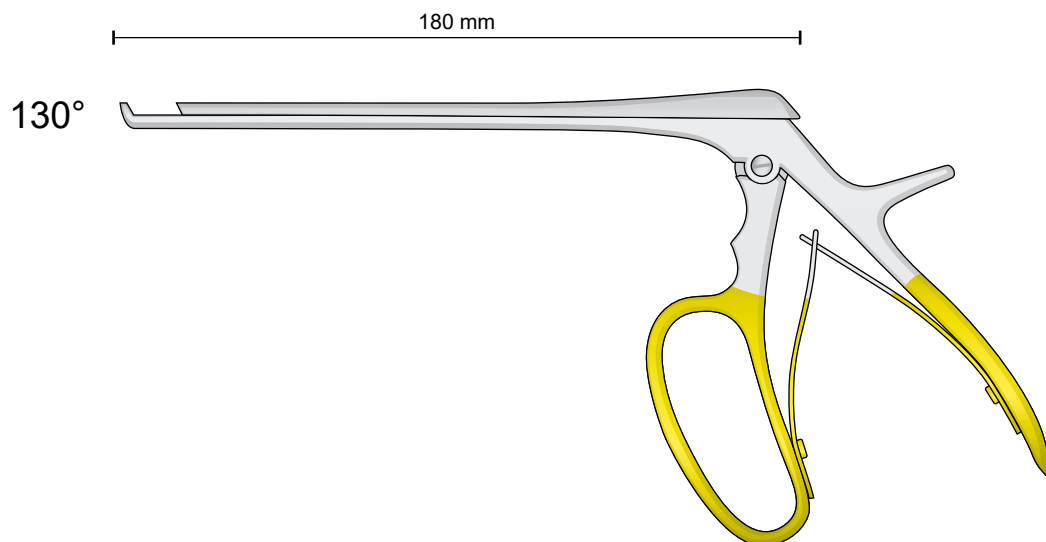

FERRIS - SMITH - KERRISON
L 1488-01 / L 1488-05

Diritta
Stright
Gerade
Droites
Rectas

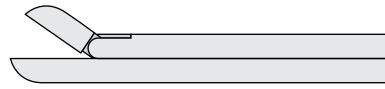

L 1489-01 2 x 10 mm

L 1489-02 3 x 10 mm

L 1489-03 4 x 10 mm

L 1489-04 6 x 12 mm

Curva verso l'alto
Top curved
Aufwärtsgebogen
Courbe vers le haut
Curvos

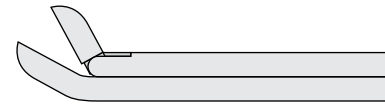

L 1489-05 2 x 10 mm

L 1489-06 3 x 10 mm

L 1489-07 4 x 10 mm

Curva verso il basso
Bottom curved
Abwärts gebogen
Courbe vers le bas
Curvos

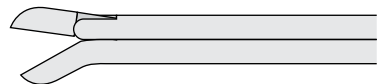

L 1489-08 2 x 10 mm

L 1489-09 3 x 10 mm

L 1489-10 4 x 10 mm

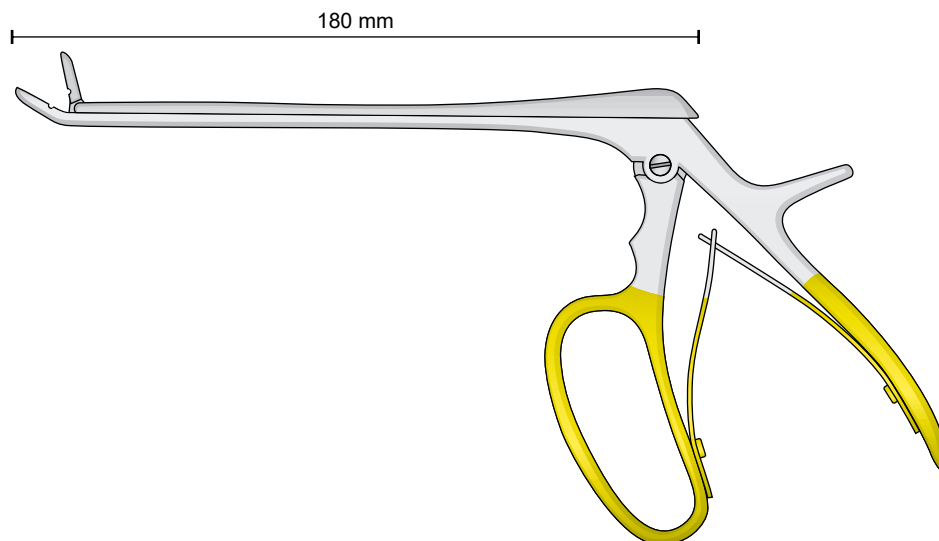

FERRIS - SMITH - CUSHING

L 1489-01 / L 1489-10

Pinze per biopsia
Laminectomy rongeurs
Laminectomy Rongeur
Pincas a laminectomia
Pinzas cortantes para laminectomia

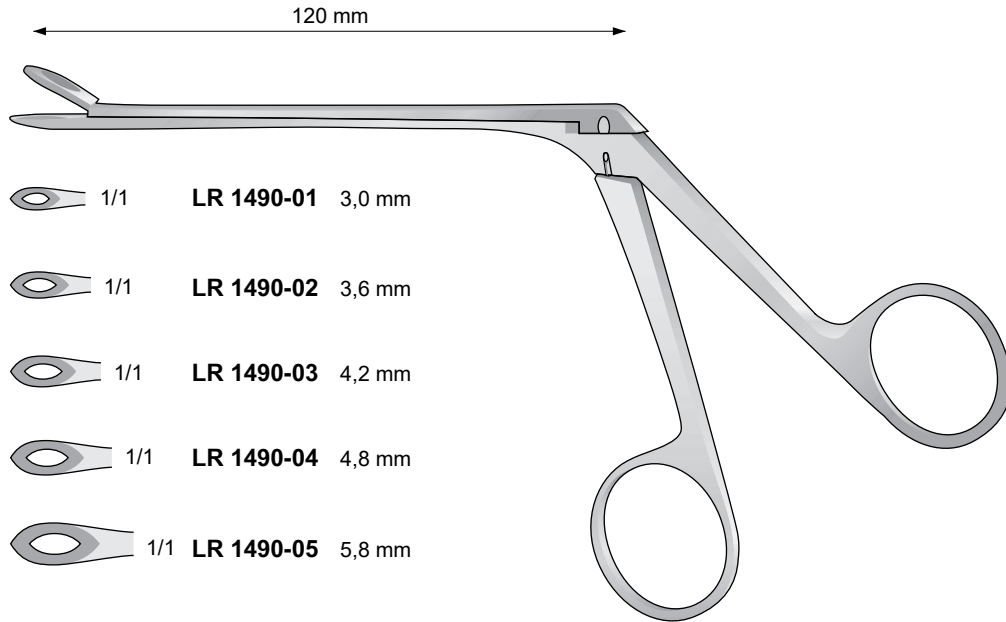

WEIL-BLAKESLEY
LR 1490-01 / LR 1490-05
190 mm

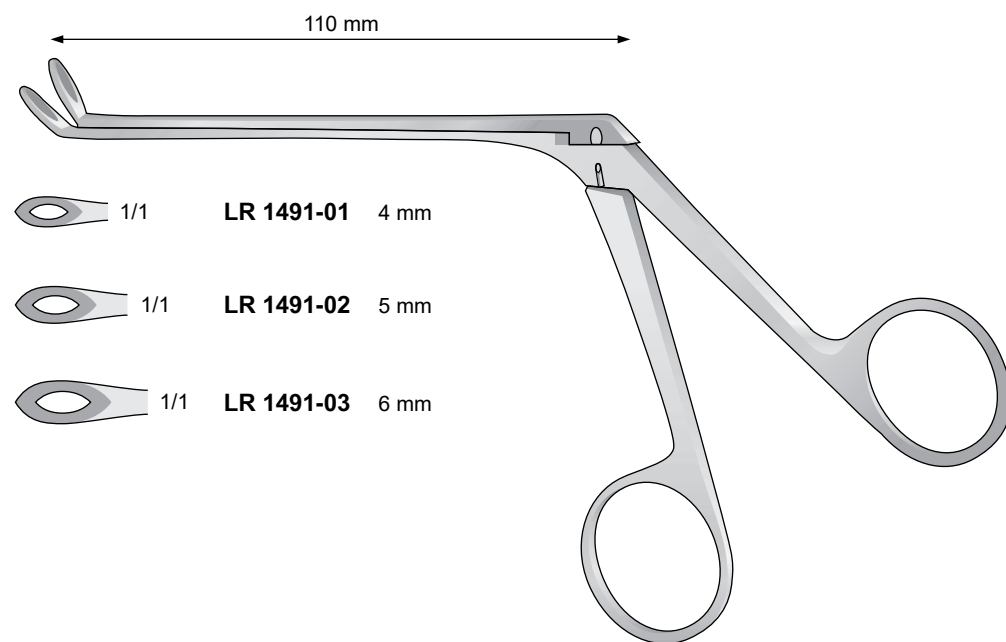

WEIL-BLAKESLEY
LR 1491-01 / LR 1491-03
190 mm

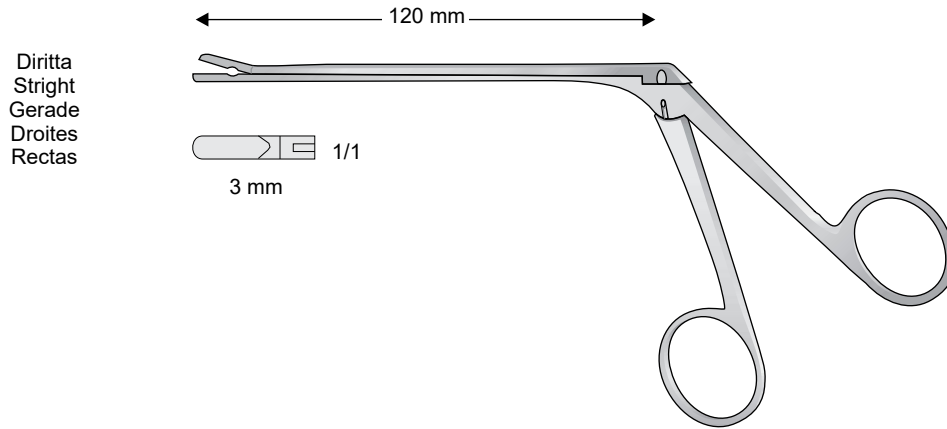

TAKAHASHI
LR 1492

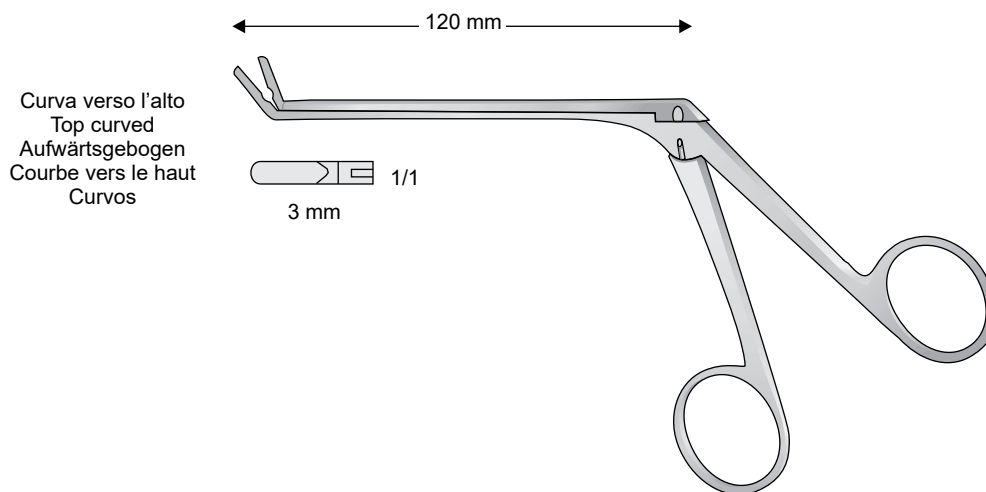

TAKAHASHI
LR 1493

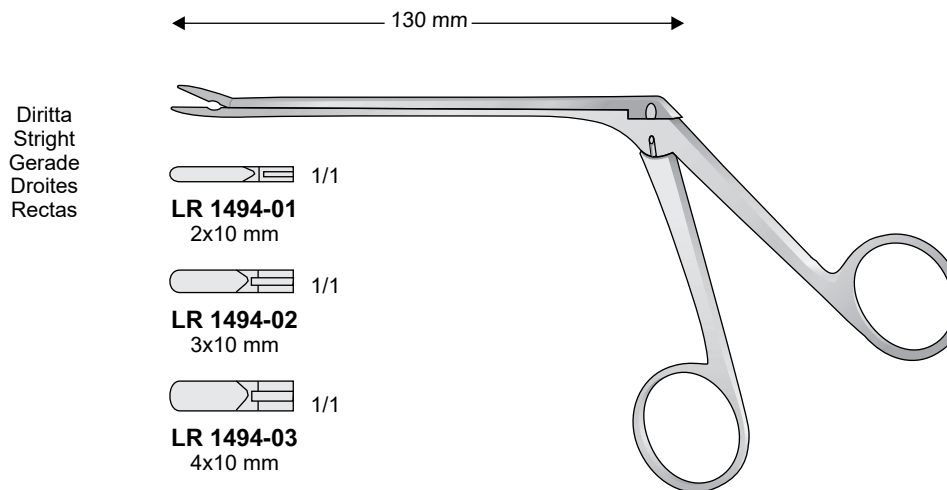

LOVE-GRUENWALD
LR 1494-01 / LR 1494-03

Pinze per biopsia
 Laminectomy rongeurs
 Laminectomy Rongeurs
 Pincas a laminectomia
 Pinzas cortantes para laminectomia

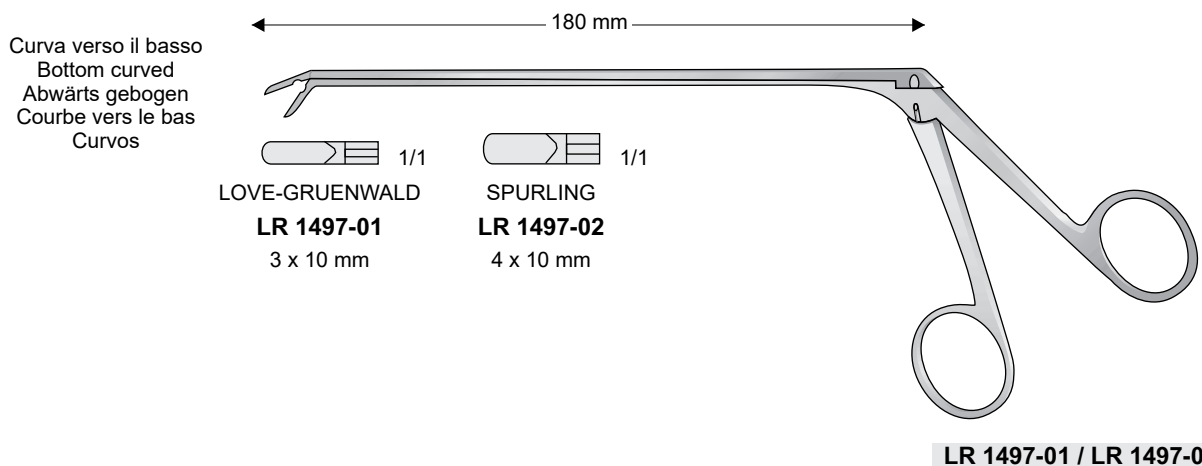
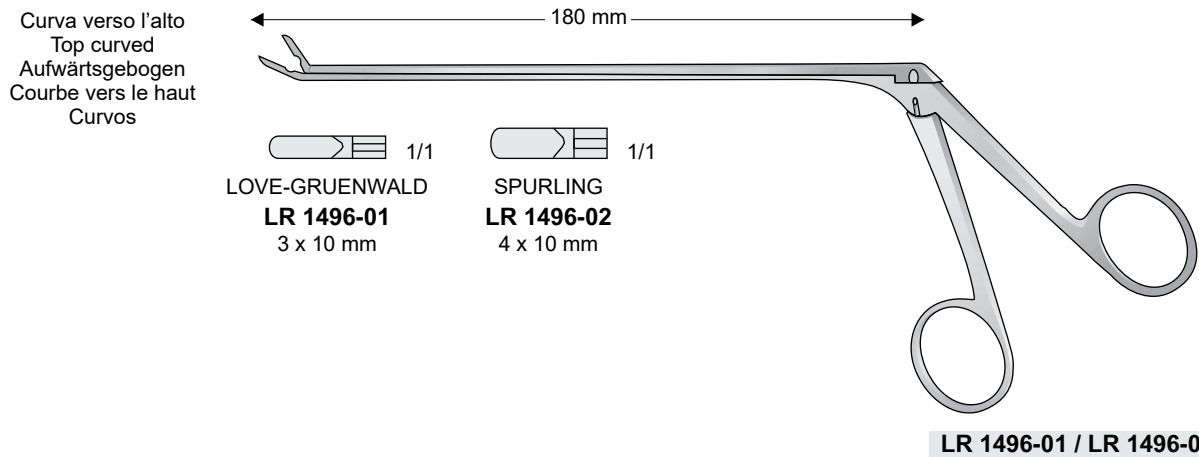
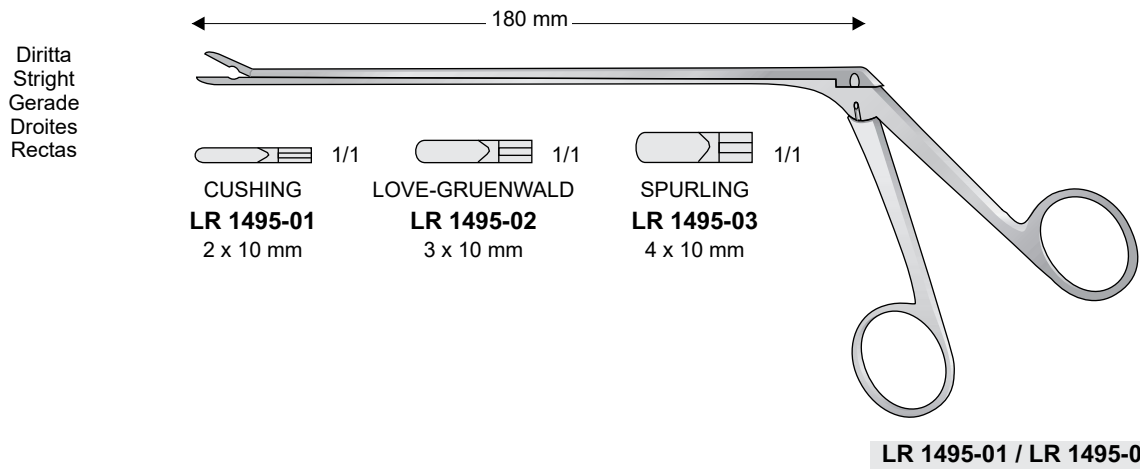

Diritta
Stright
Gerade
Droites
Rectas

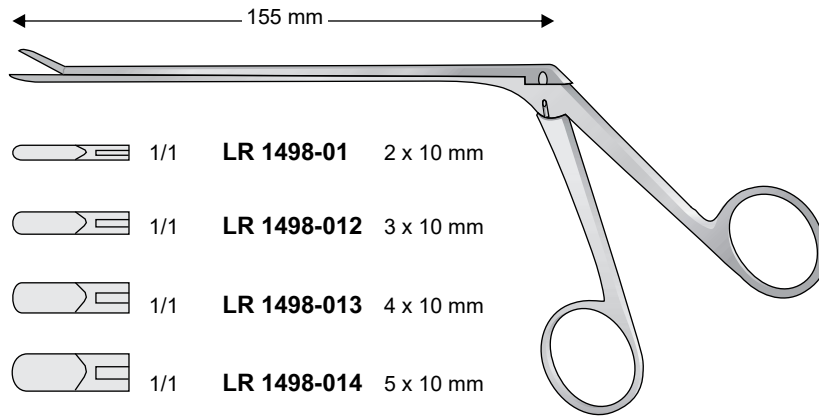

CASPAR

LR 1498-01 / LR 1498-04

Curva verso l'alto
Top curved
Aufwärtsgebogen
Courbe vers le haut
Curvos

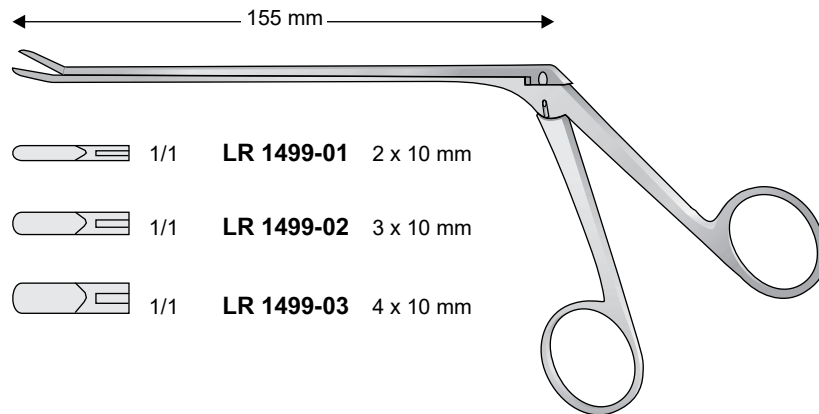

CASPAR

LR 1499-01 / LR 1499-03

Curva verso il basso
Bottom curved
Abwärts gebogen
Courbe vers le bas
Curvos

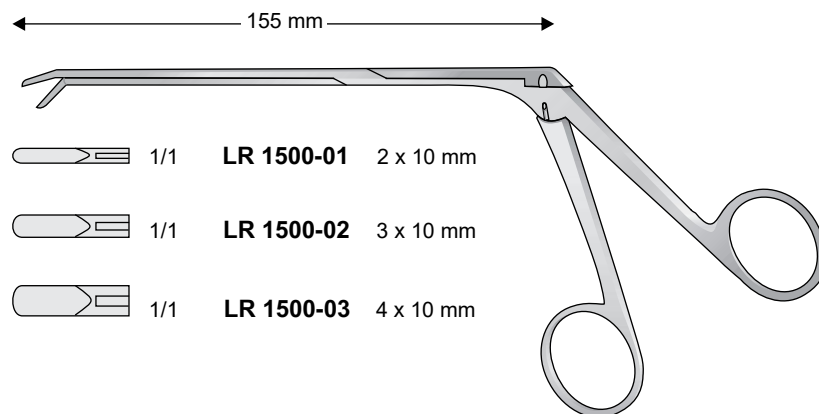

CASPAR

LR 1500-01 / LR 1500-03

Pinze per biopsia
 Laminectomy rongeurs
 Laminectomy Rongeurs
 Pinces a laminectomia
 Pinzas cortantes para laminectomia

Diritta
 Stright
 Gerade
 Droites
 Rectas

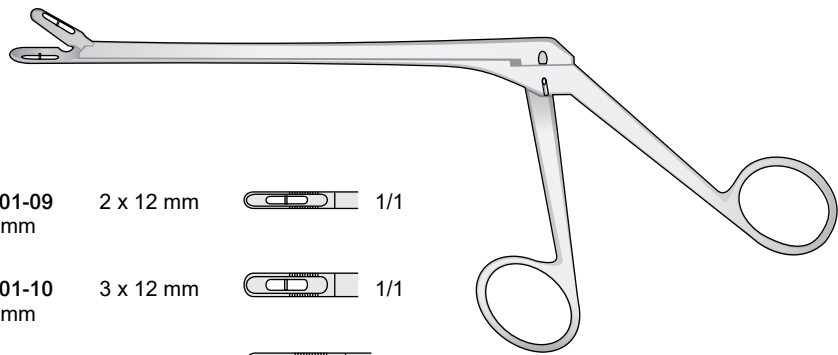

CASPAR

LR 1501-01 140 mm	LR 1501-04 160 mm	LR 1501-09 185 mm	2 x 12 mm		1/1
LR 1501-02 140 mm	LR 1501-05 160 mm	LR 1501-10 185 mm	3 x 12 mm		1/1
LR 1501-03 140 mm	LR 1501-06 160 mm	LR 1501-11 185 mm	4 x 14 mm		1/1
	LR 1501-07 160 mm	LR 1501-12 185 mm	5 x 14 mm		1/1
	LR 1501-08 160 mm	LR 1501-13 185 mm	6 x 16 mm		1/1

CASPAR
LR 1501-01 / LR 1501-13

Curva verso l'alto
 Top curved
 Aufwärtsgebogen
 Courbe vers le haut
 Curvos

150°

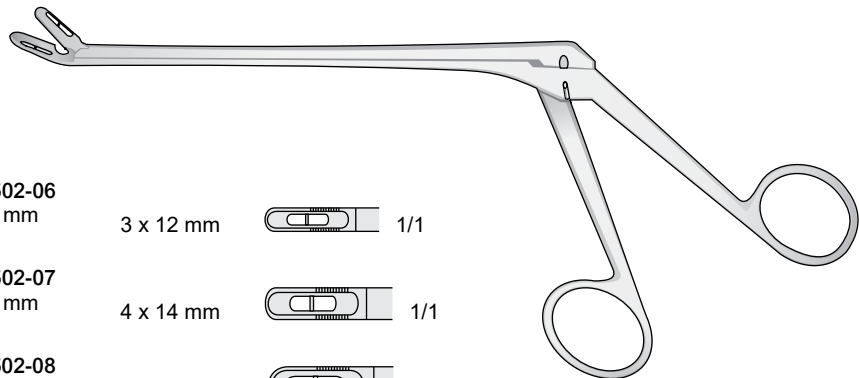

CASPAR

LR 1502-01 140 mm	LR 1502-03 160 mm	LR 1502-06 185 mm	3 x 12 mm		1/1
LR 1502-02 140 mm	LR 1502-04 160 mm	LR 1502-07 185 mm	4 x 14 mm		1/1
	LR 1502-05 160 mm	LR 1502-08 185 mm	5 x 14 mm		1/1

CASPAR
LR 1502-01 / LR 1502-08

Curva verso il basso
 Bottom curved
 Abwärts gebogen
 Courbe vers le bas
 Curvos

150°

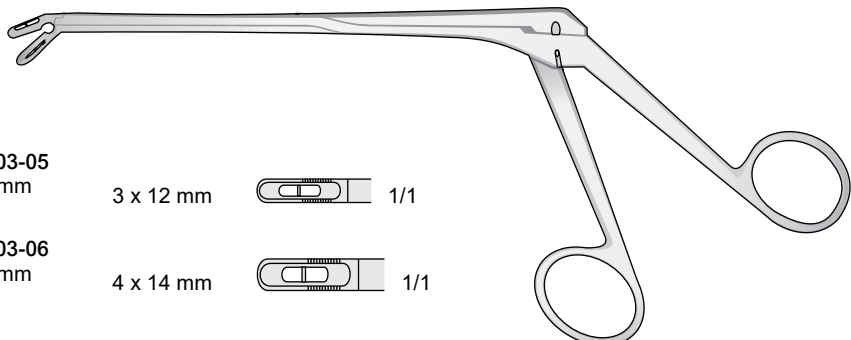

CASPAR

LR 1503-01 140 mm	LR 1503-03 160 mm	LR 1503-05 185 mm	3 x 12 mm		1/1
LR 1503-02 140 mm	LR 1503-04 160 mm	LR 1503-06 185 mm	4 x 14 mm		1/1

CASPAR
LR 1503-01 / LR 1503-06



Diritta
Stright
Gerade
Droites
Rectas

210 mm

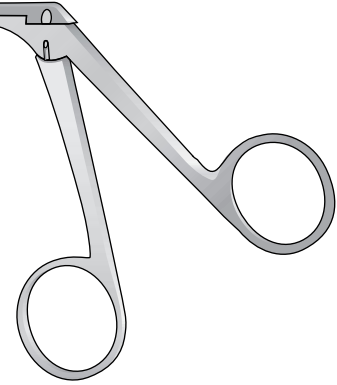
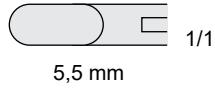

**WAGNER
LR 1504**

Diritta
Stright
Gerade
Droites
Rectas

255 mm

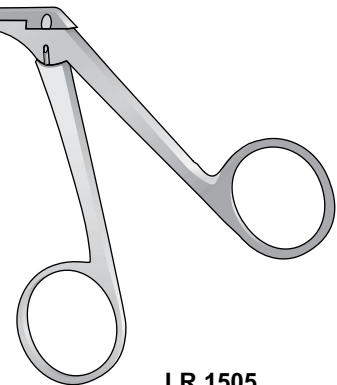
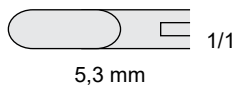

LR 1505

Curva verso l'alto
Top curved
Aufwärtsgebogen
Courbe vers le haut
Curvos

255 mm

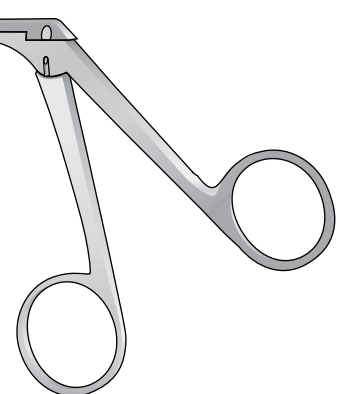
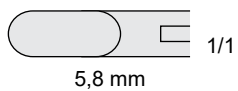

**SYPERT
LR 1506**

Pinze per biopsia
 Laminectomy rongeurs
 Laminectomy Rongeurs
 Pincas a laminectomia
 Pinzas cortantes para laminectomia

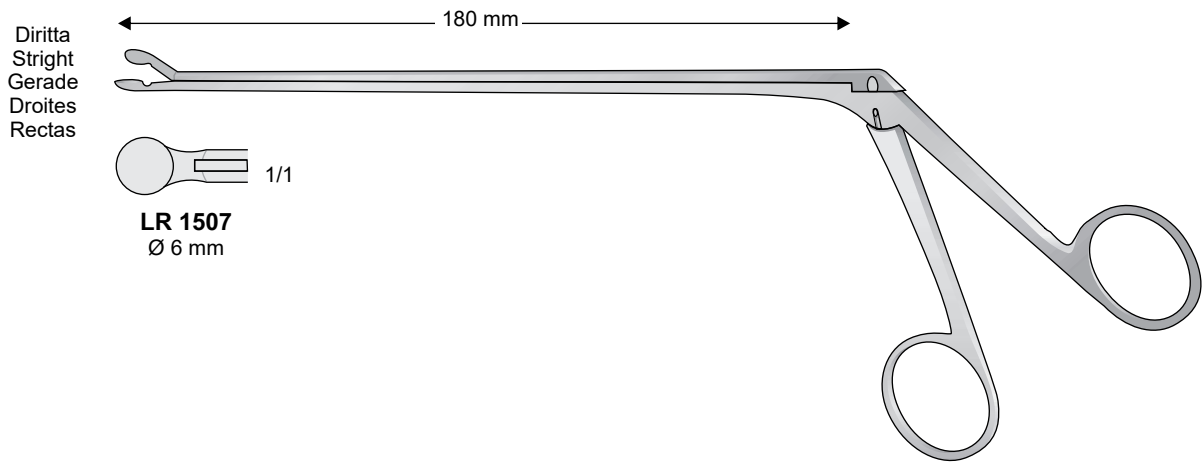

**OLDBERG
 LR 1507**

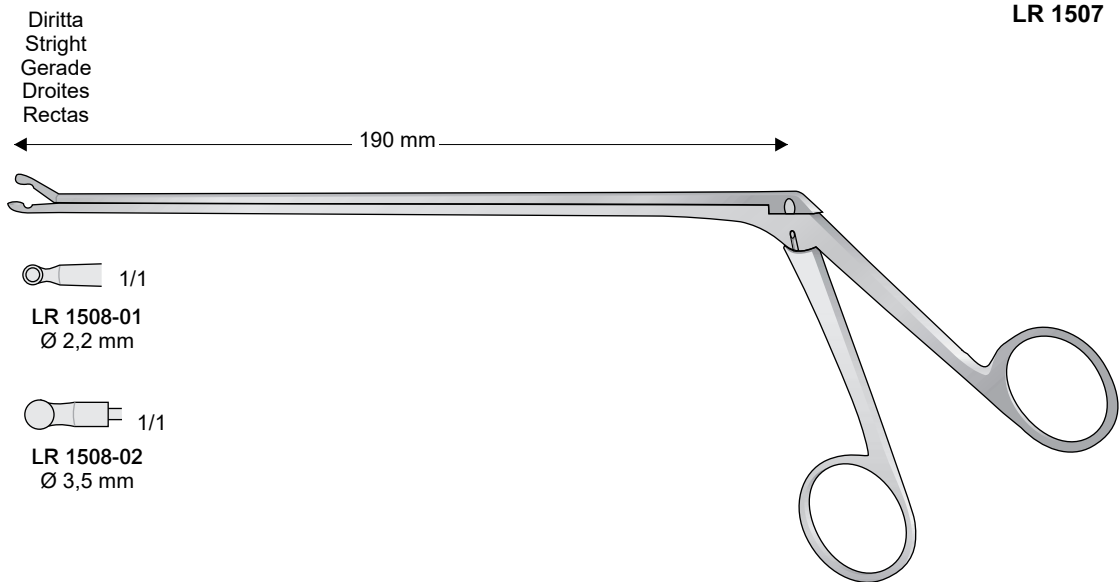

**YASARGIL
 LR 1508-01 / LR 1508-02**

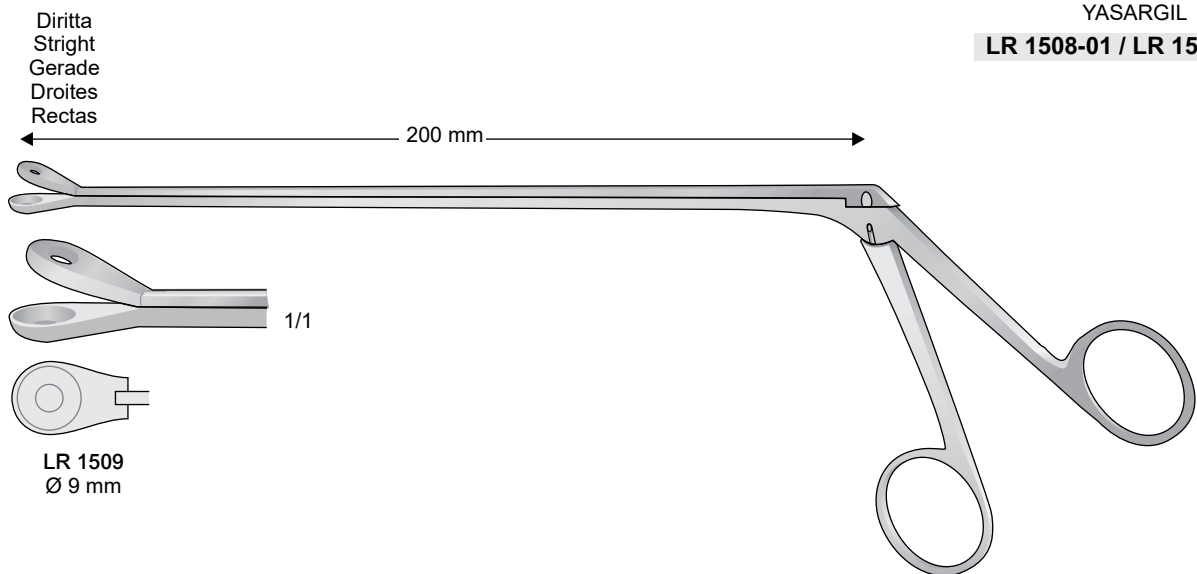

**LANDOLT
 LR 1509**

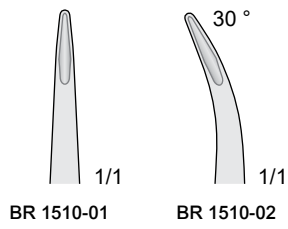
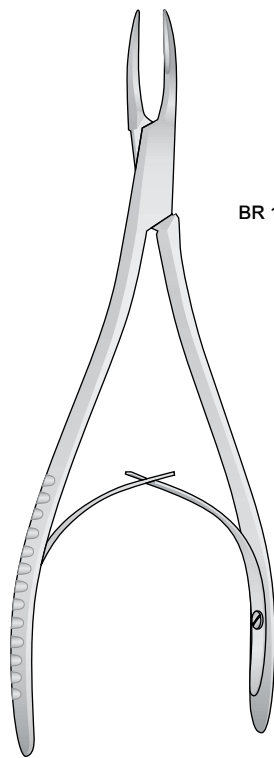

MINI-FRIEDMANN
BR 1510-01 / BR 1510-03
15 cm

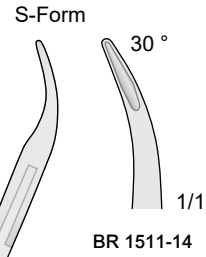
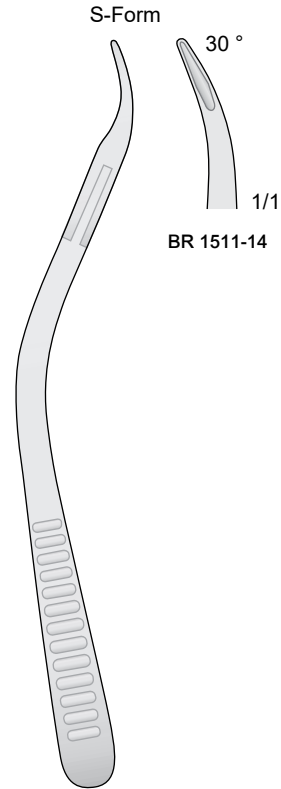

MINI-FRIEDMANN
BR 1511-14 14.5 cm

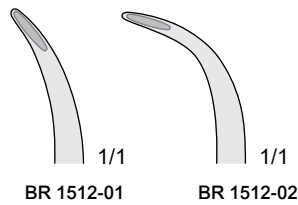
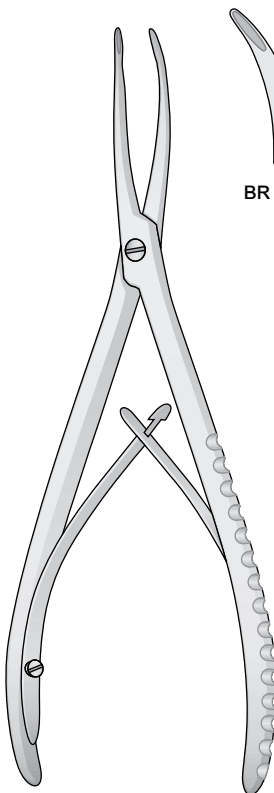

STELLBRINK
BR 1512-01 / BR 1512-02
17 cm

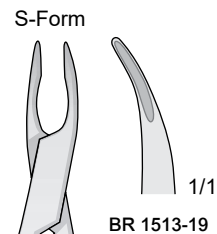
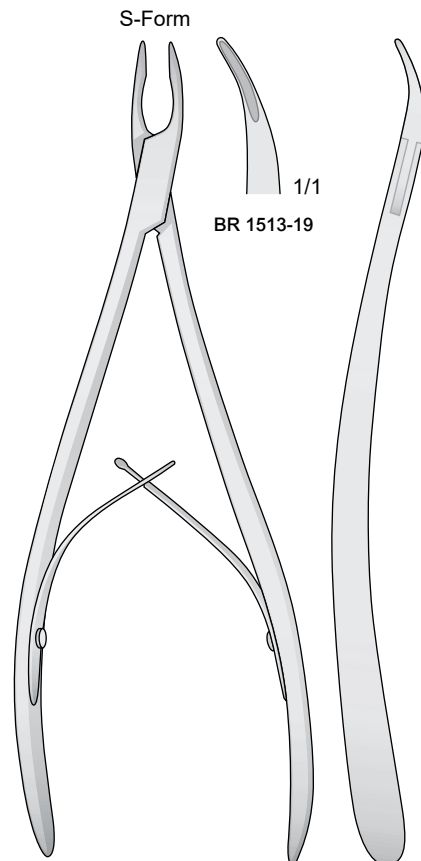

STELLBRINK
BR 1513-19 19 cm

Pinze ossivore
 Bone rongeurs
 Hohlmeißelzangen
 Pincés-gouges
 Pinza-gubias

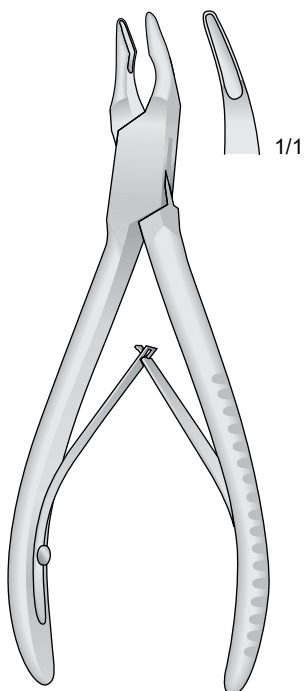

MINI FRIEDMANN
BR 1514-12 12 cm

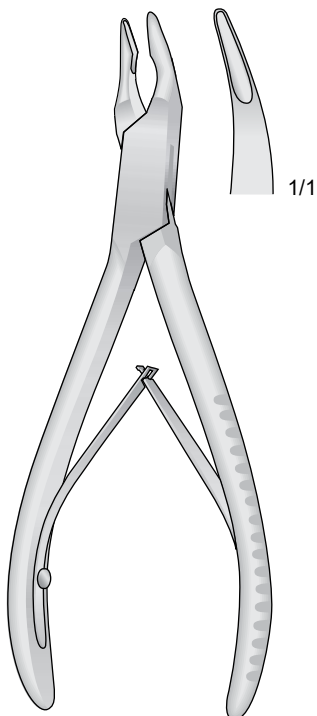

FRIEDMANN
BR 1515-14 14 cm

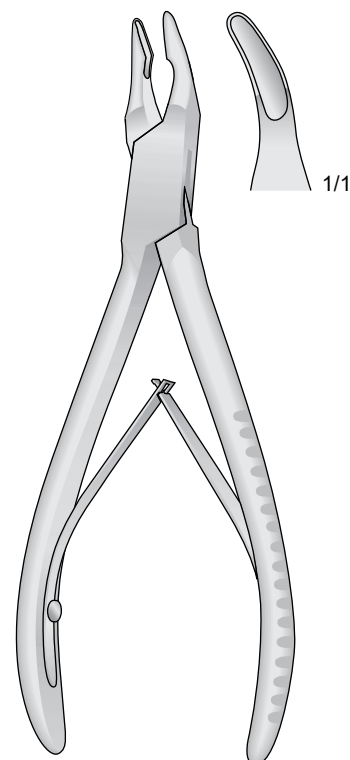

BLUMENTHAL
BR 1516-15 15.5 cm

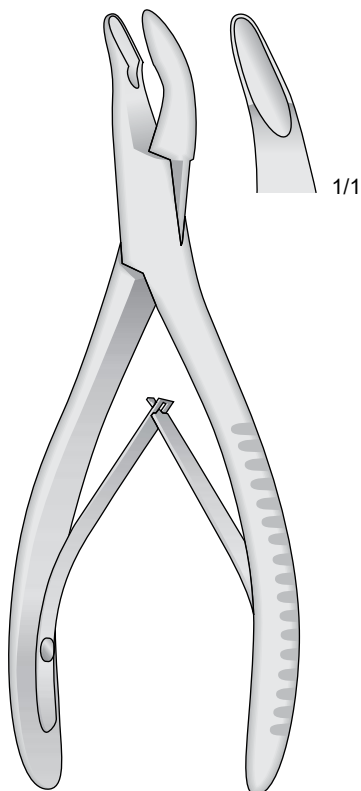

MEAD
BR 1517-16 16.5 cm

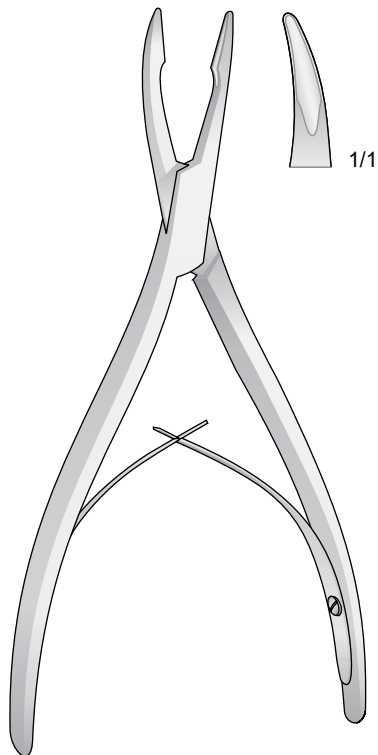

FRIEDMANN
BR 1518-16 16 cm

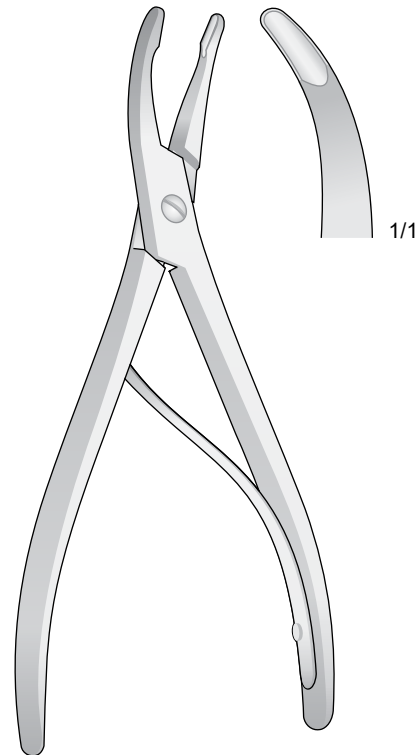

LUER
BR 1519-15 15.5 cm

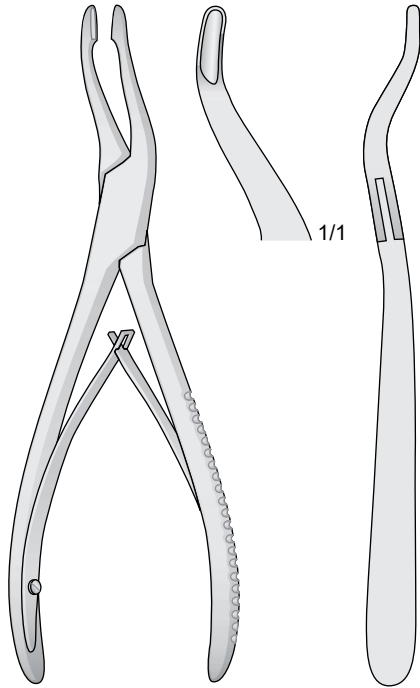

ALEXANDER
BR 1520-14 14 cm

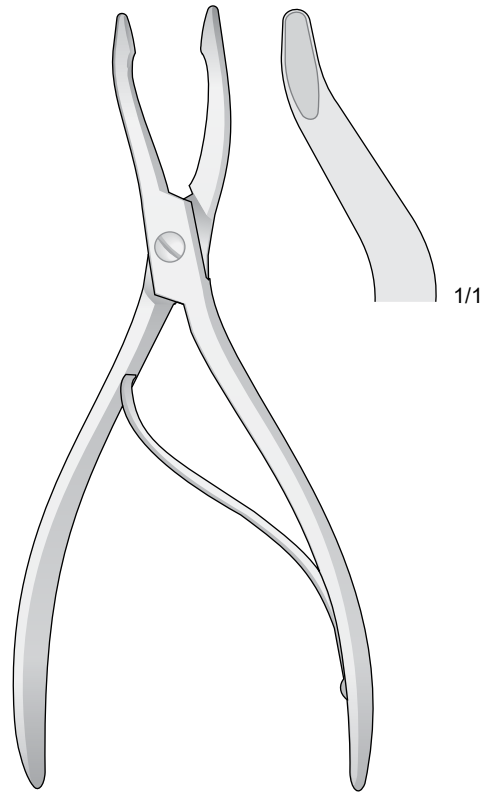

JANSEN-LEUER
BR 1521-18 18 cm

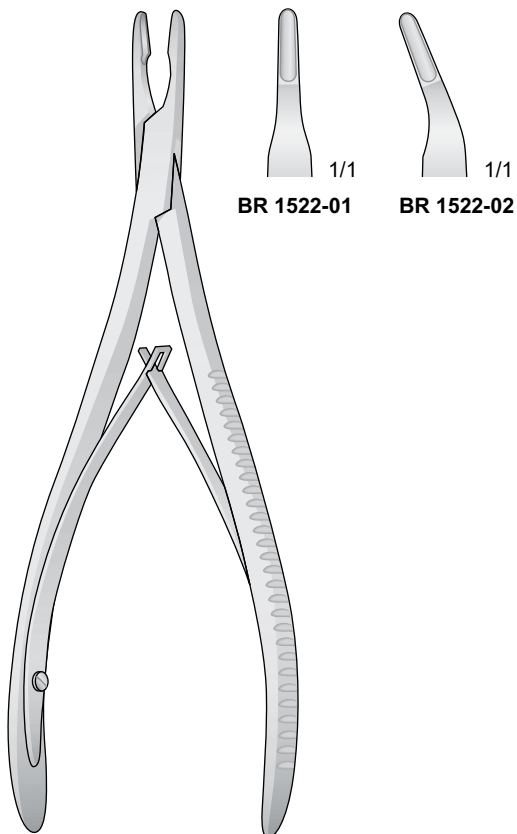

LEMPERT
BR 1522-01 / BR 1522-02
19 cm

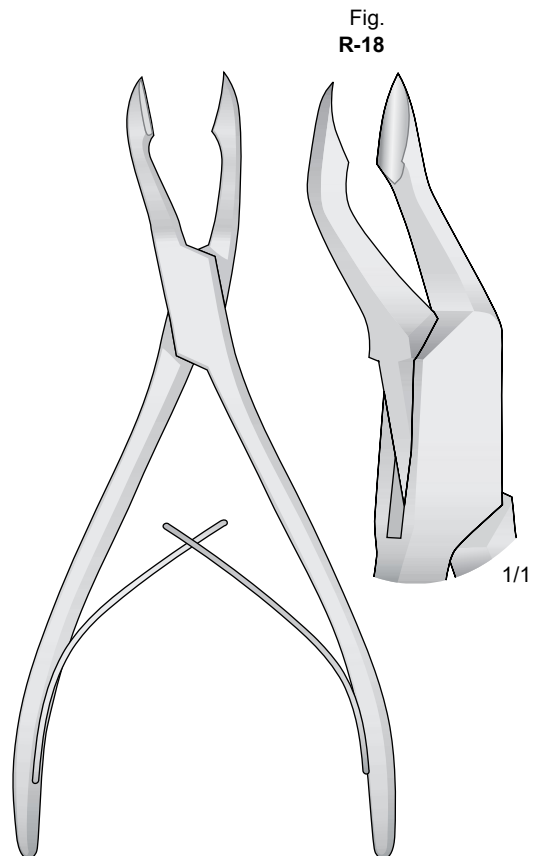

BR 1523-17 17.5 cm

Pinze ossivore
 Bone rongeurs
 Hohlmeißelzangen
 Pincés-gouges
 Pinza-gubias

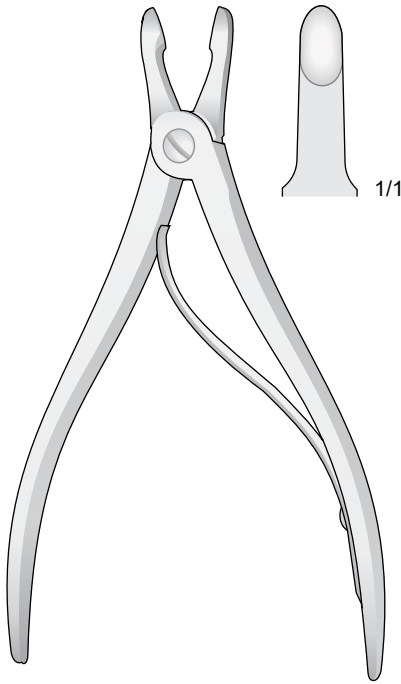

HARTMANN
BR 1524-15 15.5 cm

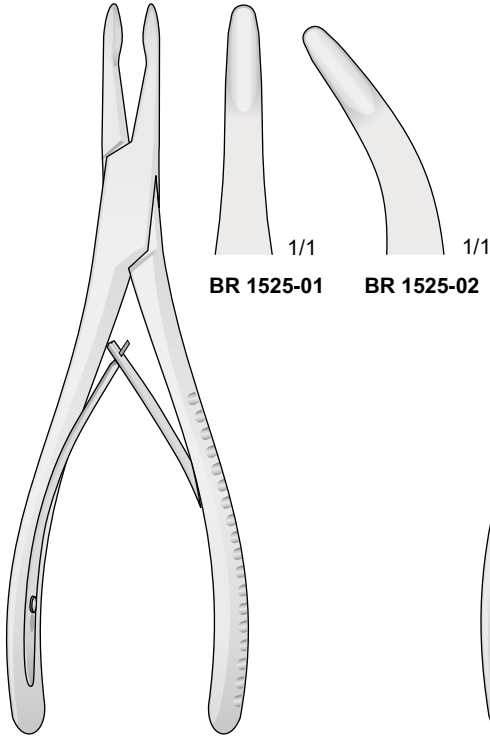

JANSEN
BR 1525-01 / BR 1525-02
 17 cm

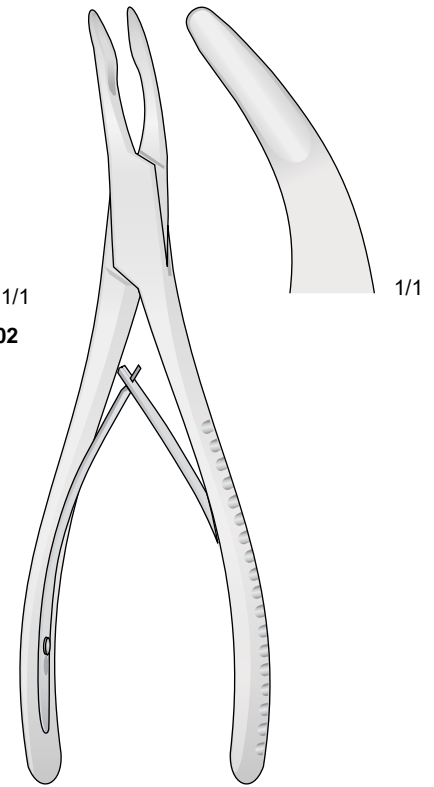

OLIVECRONA
BR 1526-19 19 cm

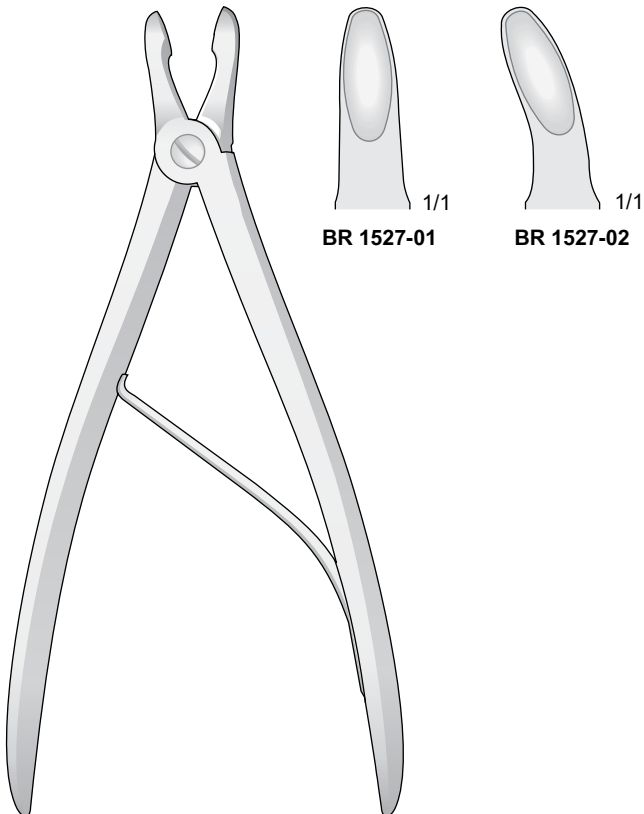

CUSHING
BR 1527-01 / BR 1527-02
 19 cm

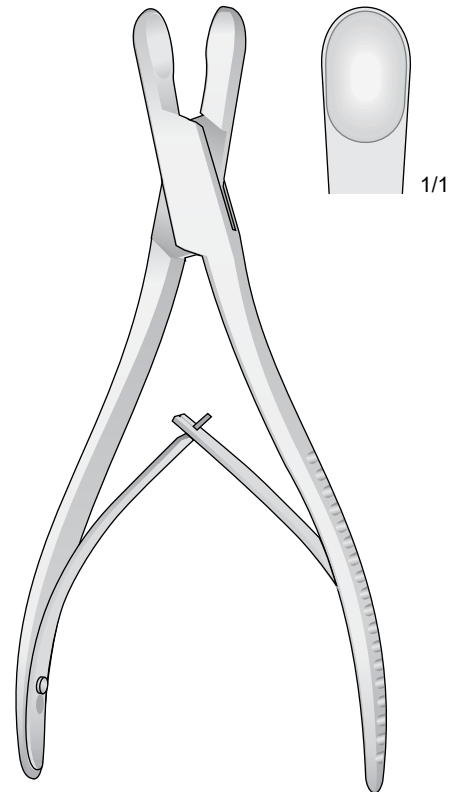

LUER-STILLE
BR 1528-18 18.5 cm

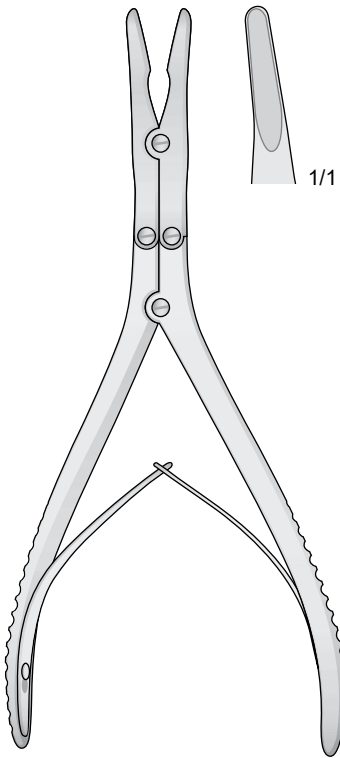

BEYER
BR 1529-18 18 cm

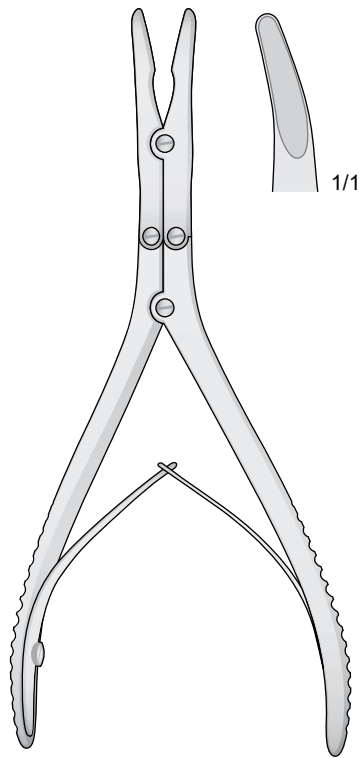

ZAUFAL-JANSEN
BR 1530-18 18 cm

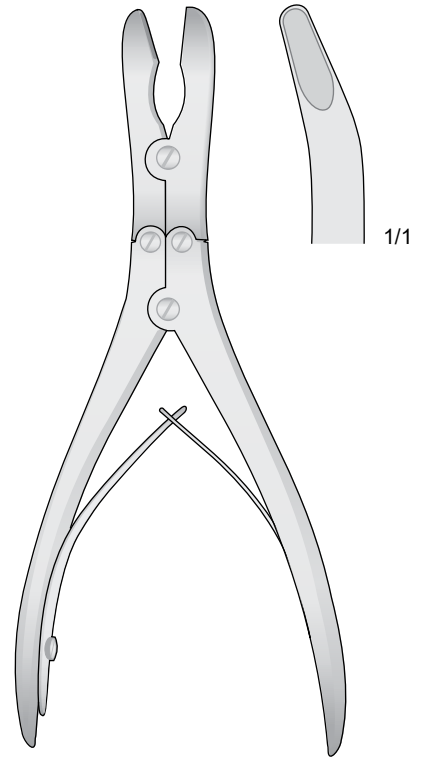

RUSKIN-STILLE
BR 1531-18 18 cm

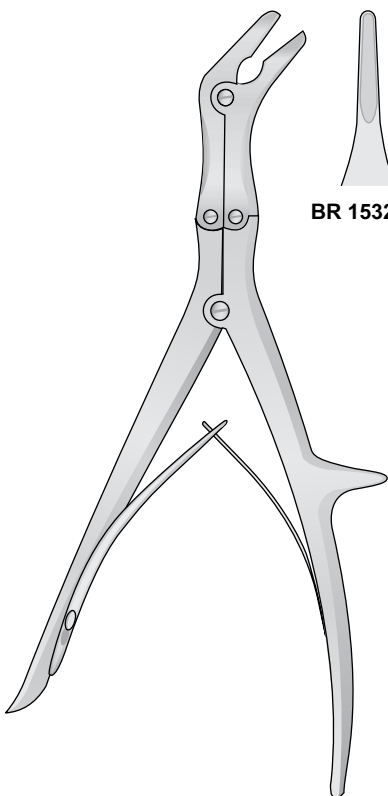

ECHLIN
BR 1532-01 / BR 1532-03
23 cm

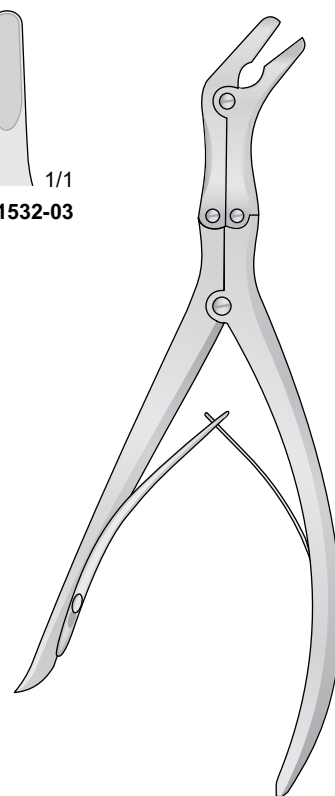
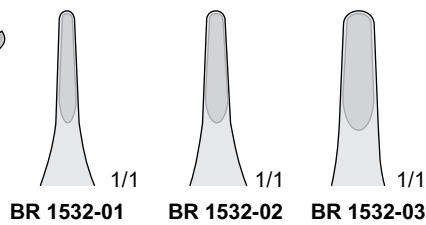

LEKSELL
BR 1533-01 / BR 1533-02

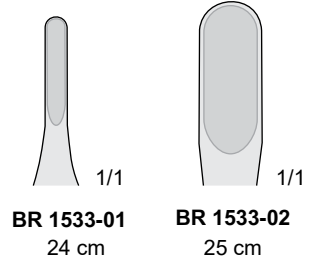

Pinze ossivore
Bone rongeurs
Hohlmeißelzangen
Pinces-gouges
Pinza-gubias

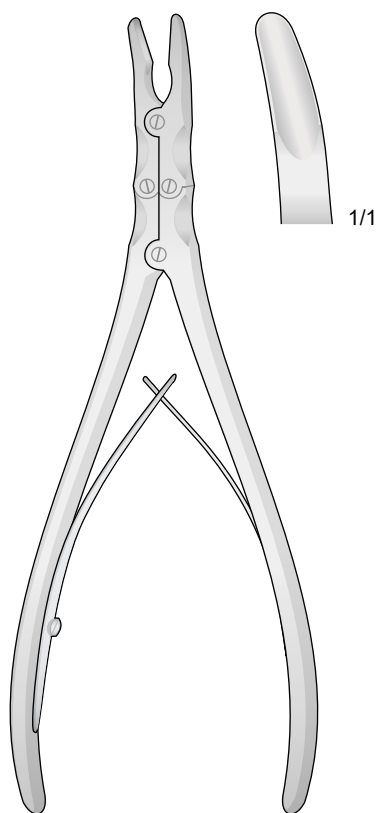

RÖTTGEN-RUSKIN

BR 1534-24 24 cm

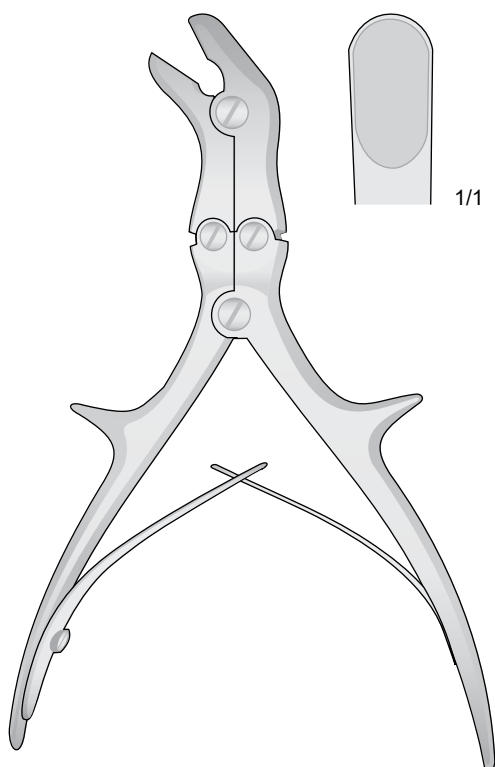

STILLE

BR 1535-21 21 cm

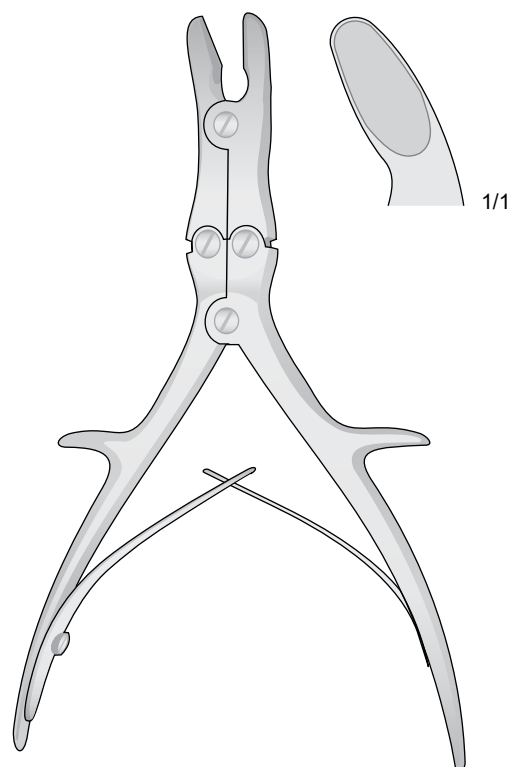

LUER-STILLE

BR 1536-21 21 cm

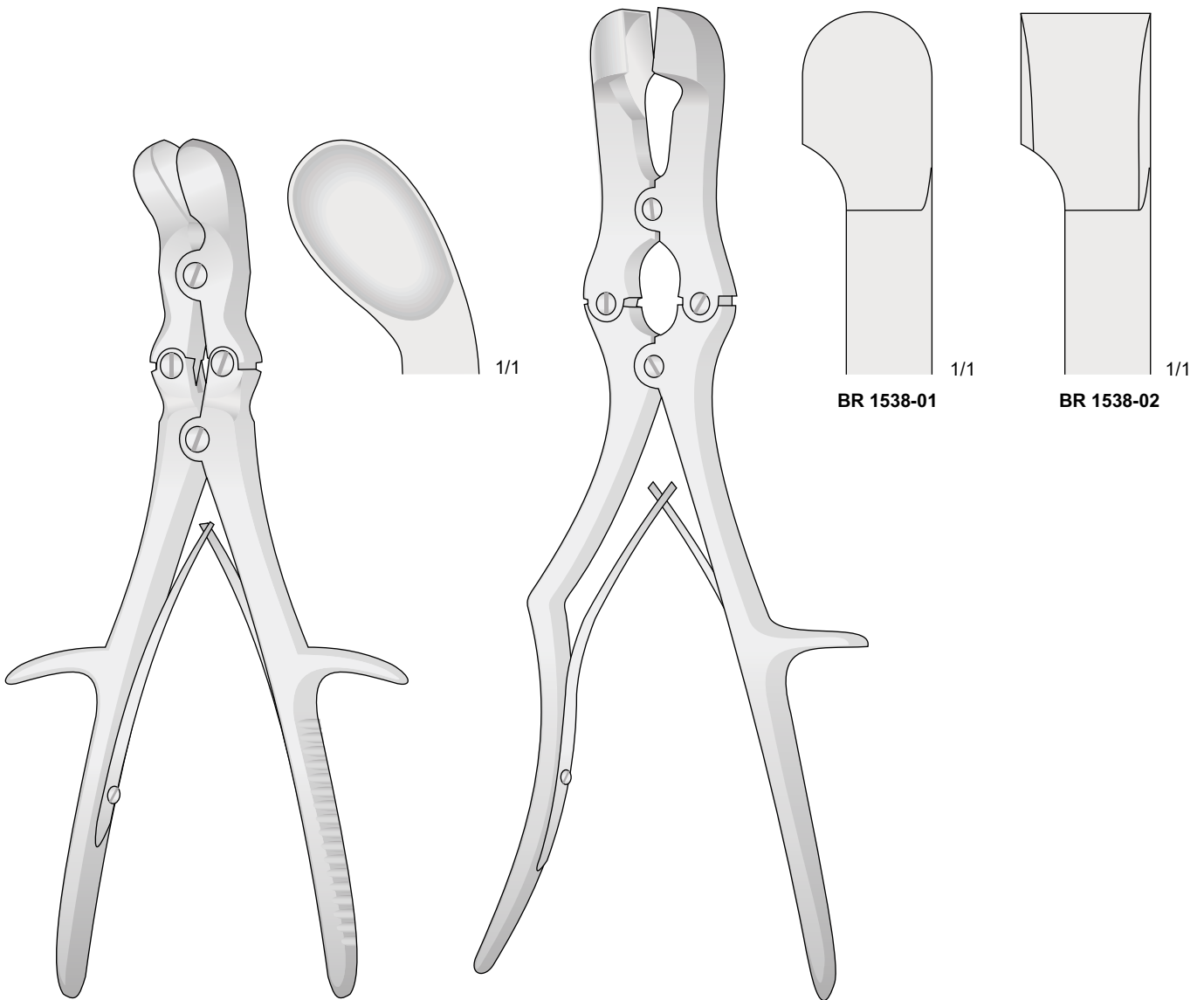

LUER-STILLE

BR 1537-26 26 cm

SAUERBRUCH

BR 1538-01 / BR 1538-02

30 cm

Pinze ossivore
Bone rongeurs
Hohlmeißelzangen
Pincés-gouges
Pinza-gubias

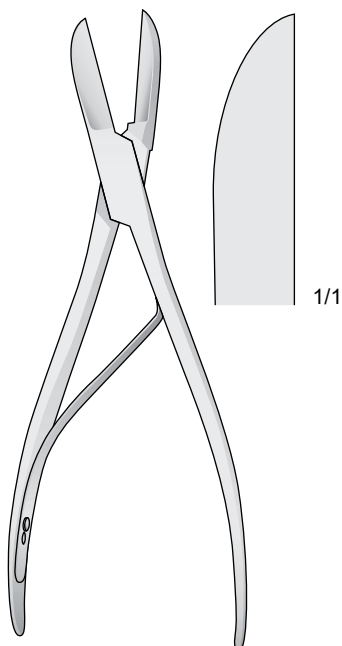

LISTON
BR 1539-22 22 cm

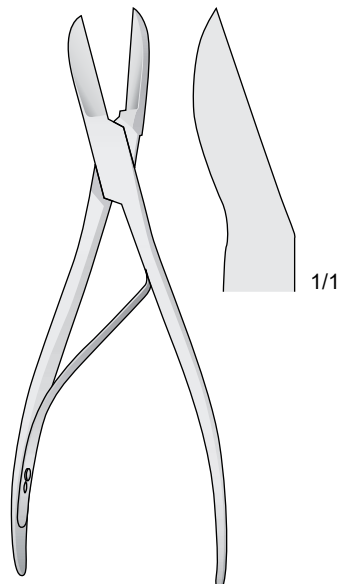

LISTON
BR 1540-17 17 cm

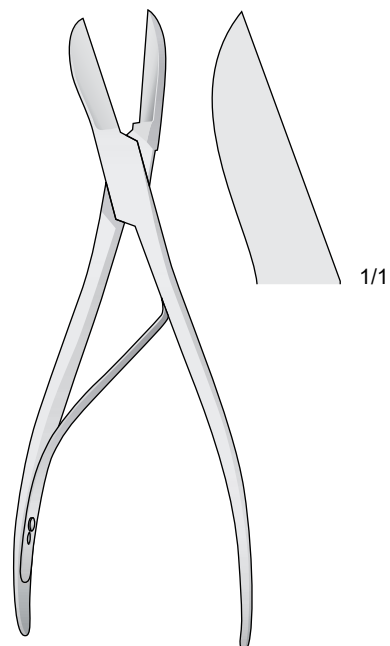

LISTON
BR 1541-22 22 cm

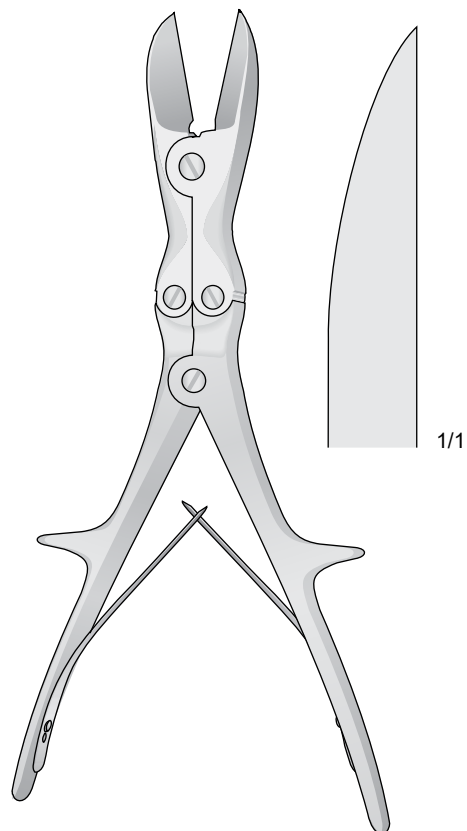

LISTON
BR 1542-27 27 cm

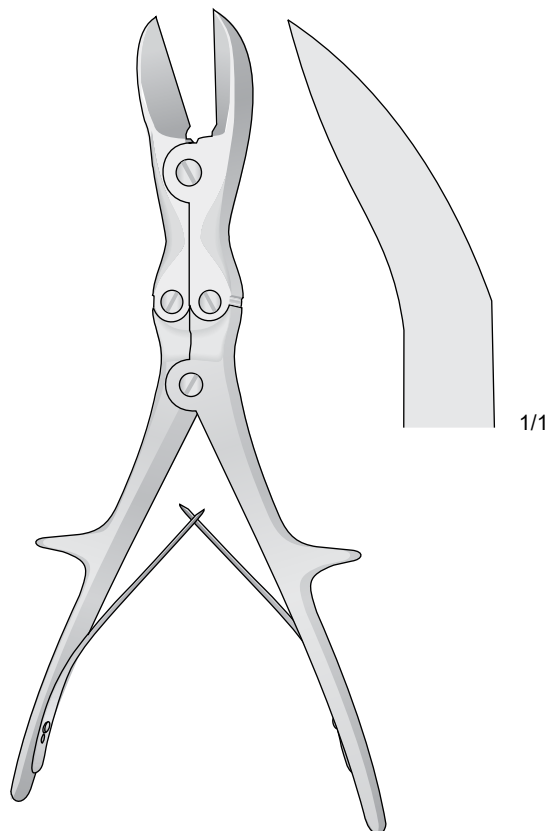

LISTON
BR 1543-27 27 cm

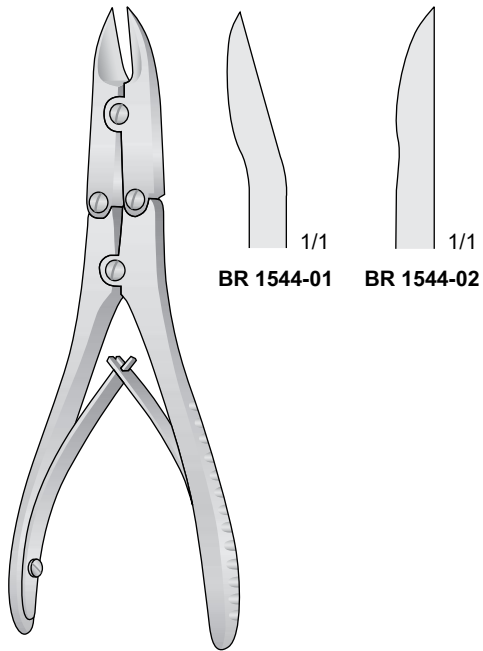

BÖHLER
BR 1544-01 / BR 1544-02
15 cm

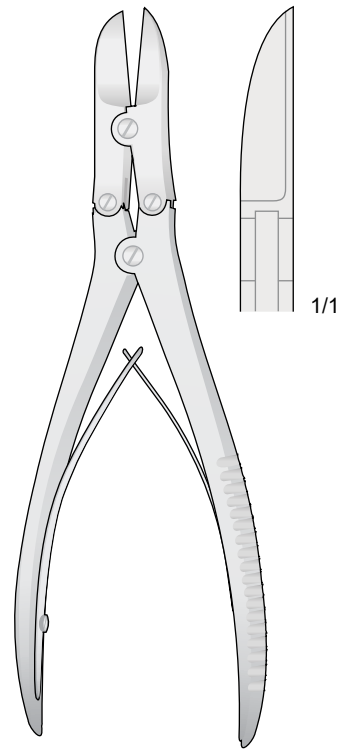

RUSKIN-LISTON
BR 1545-19 19 cm

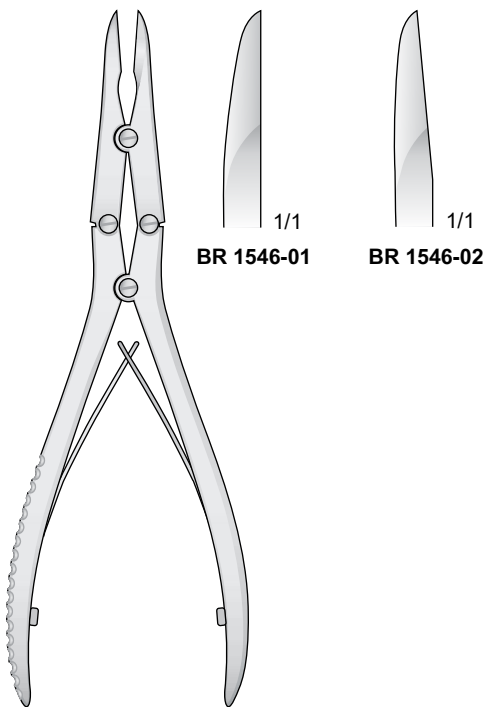

BR 1546-01 / BR 1546-02
18 cm

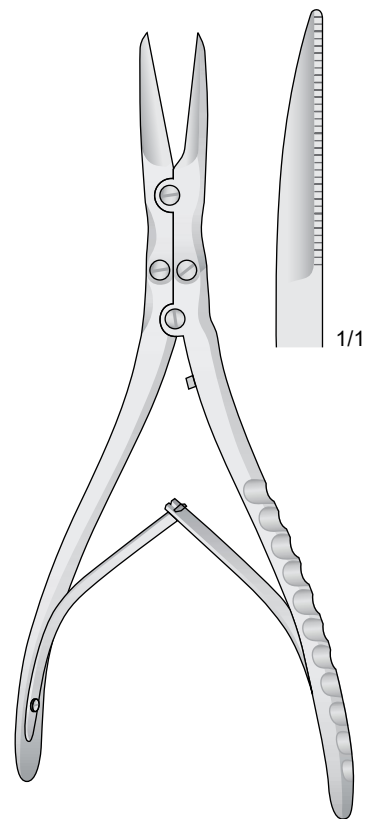

BR 1547-21 21.5 cm

Pinze ossivore
Bone rongeurs
Hohlmeißelzangen
Pinces-gouges
Pinza-gubias

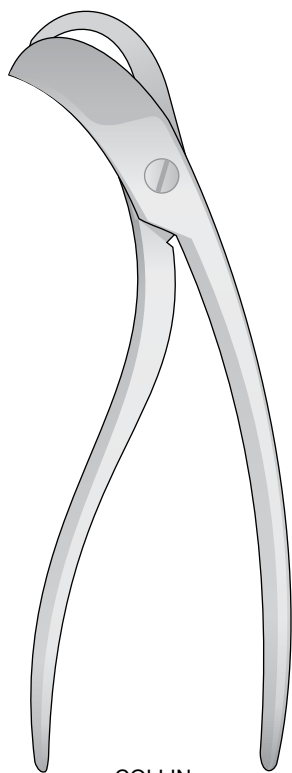

COLLIN

BR 1548-19 19.5 cm

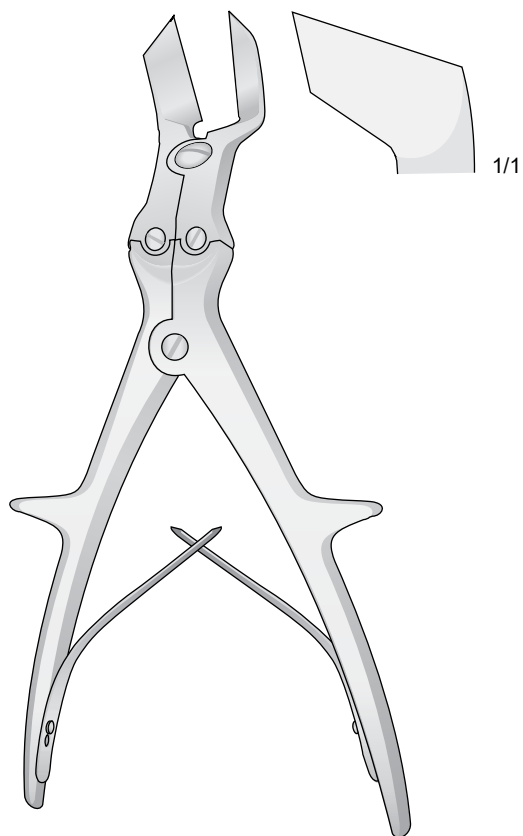

KEY-HORSLEY

BR 1549-23 23.5 cm

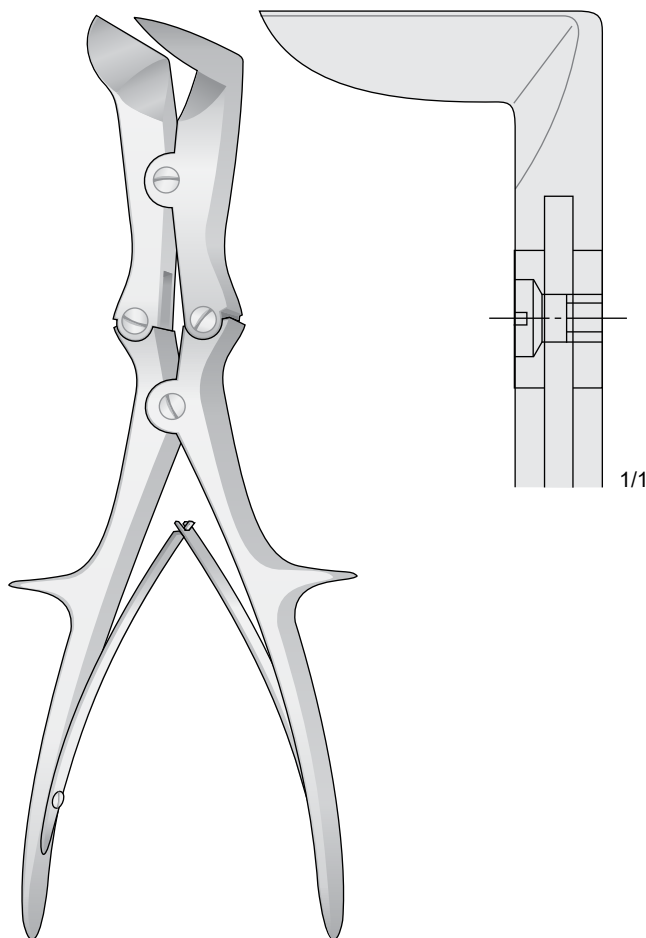

LISTON-STILLE

BR 1550-26 26.5 cm

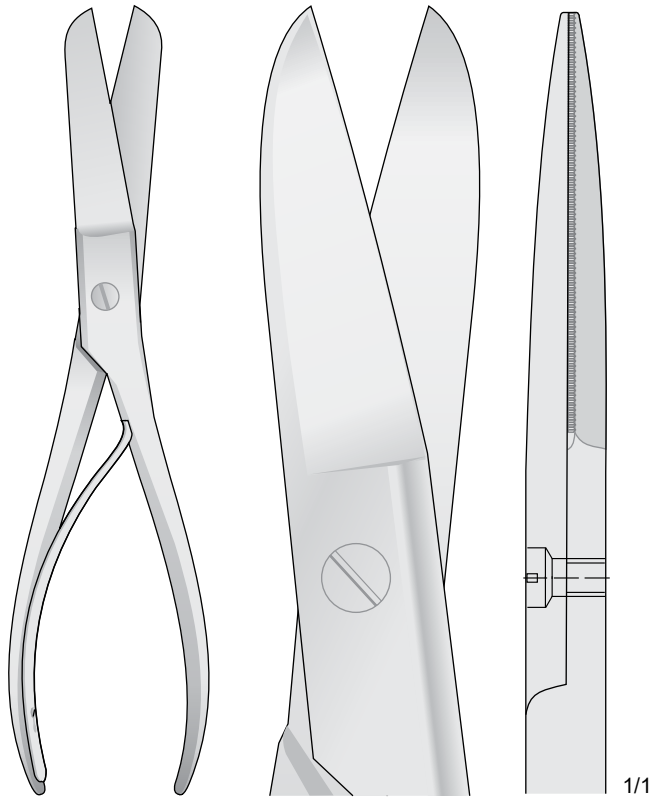

BCS 1551-23 23 cm

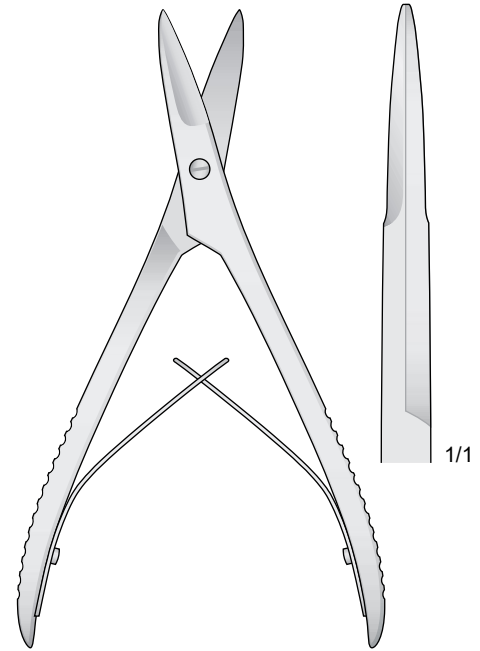

BCS 1552-16 16 cm

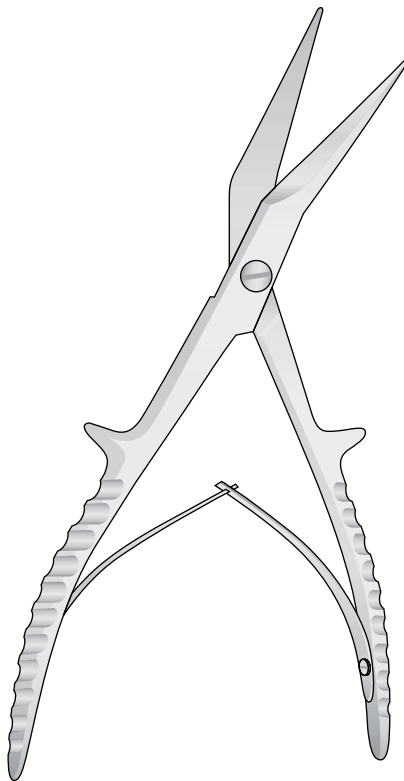

BCS 1553-19 19.5 cm

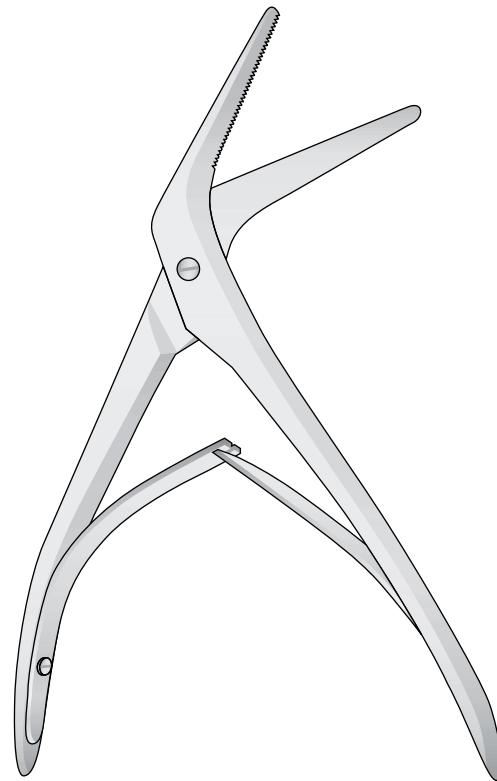

JACKSON-TESSIER
BCS 1554-19 19 cm

Costotomi, forbici per sterno
 Rib shears
 Rippenscheren, Sternumscheren
 Costotomes et ciseaux-burin à sternum
 Costotòmos

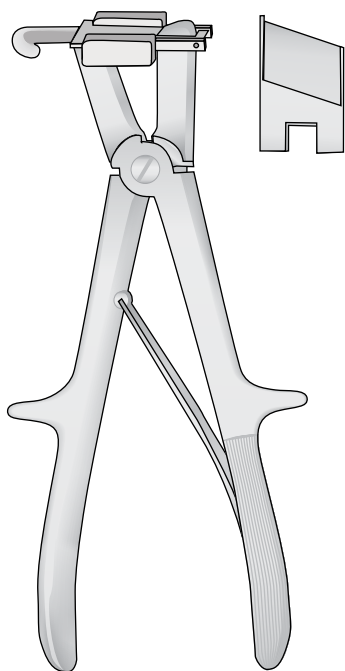

SAUERBRUCH
RS 1555-23 23 cm
RS 1555-26 26 cm

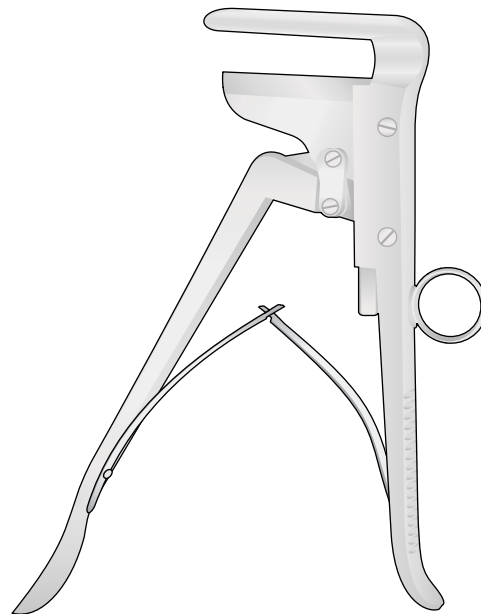

SCHUMACHER
RS 1556-21 21 cm

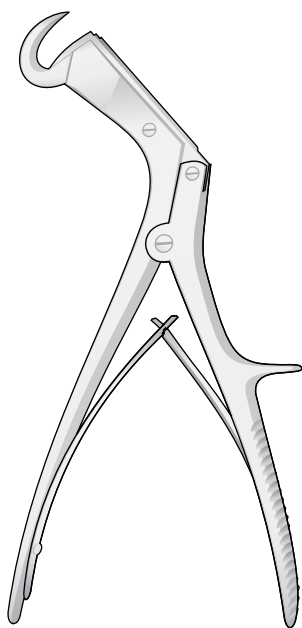

GIERTZ-STILLE
RS 1557-25 25 cm

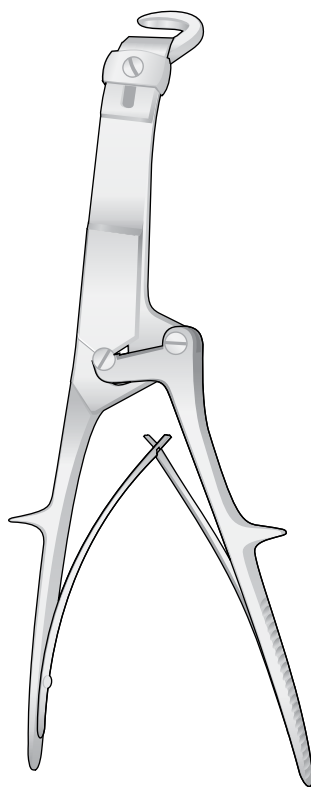

BRUNNER
RS 1558-32 32 cm - Destro
RS 1558-32 32 cm - Sinistro

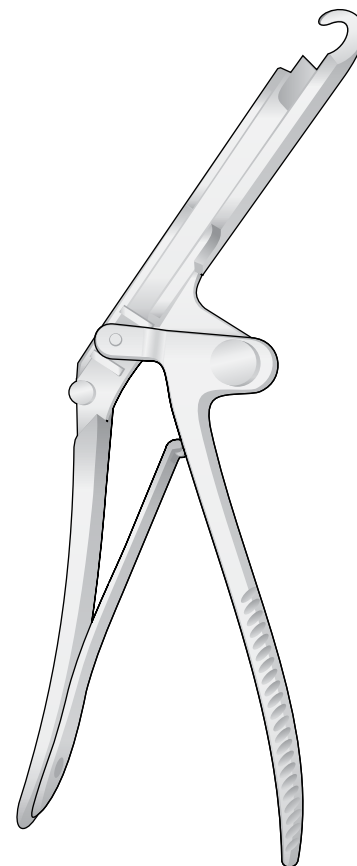

SAUERBRUCH-FREY
RS 1559-37 37 cm

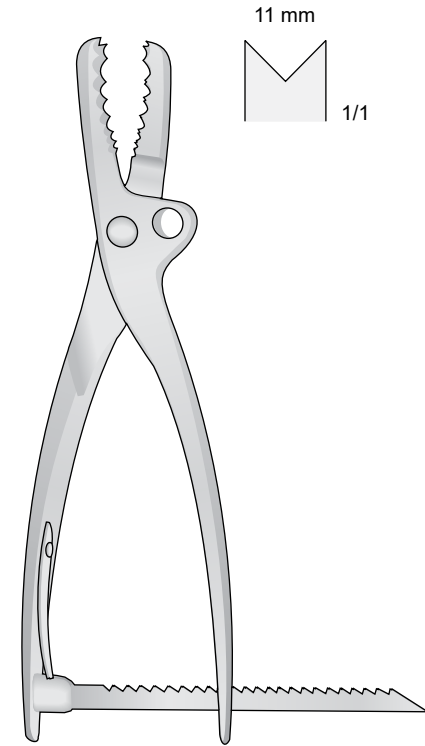

FARABEU-F-LAMBOTTE
BCS 1560-25 25 cm

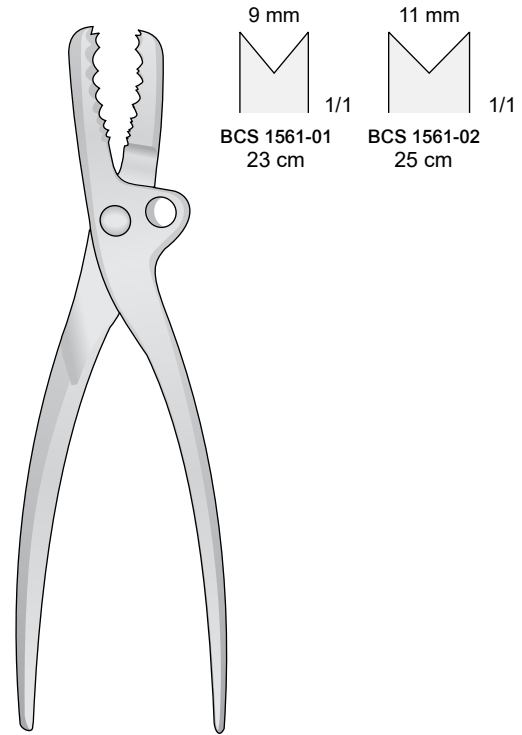

FARABEU
BCS 1561-01 / BCS 1561-02

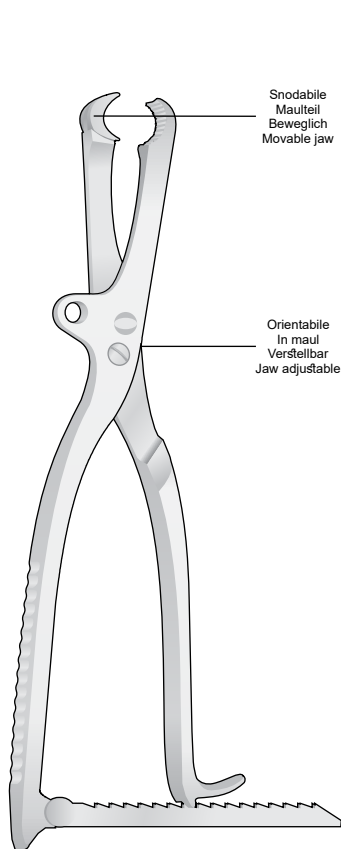

LAMBOTTE
BCS 1562-26 26.5 cm

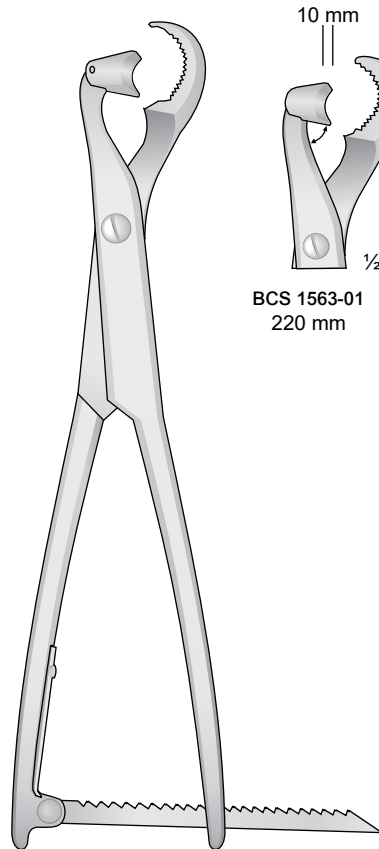

LAMBOTTE
BCS 1563-01 / BCS 1563-03
33 cm



BCS 1563-01
220 mm

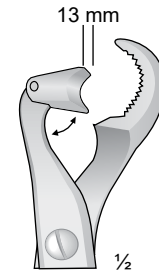

BCS 1563-02
260 mm

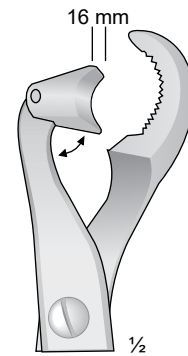

BCS 1563-03
330 mm

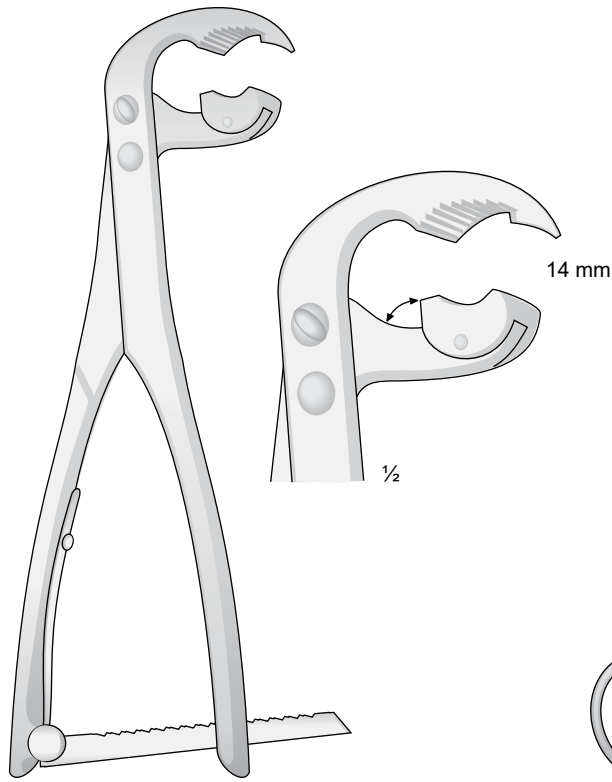

BS 1564-21 21.5 cm

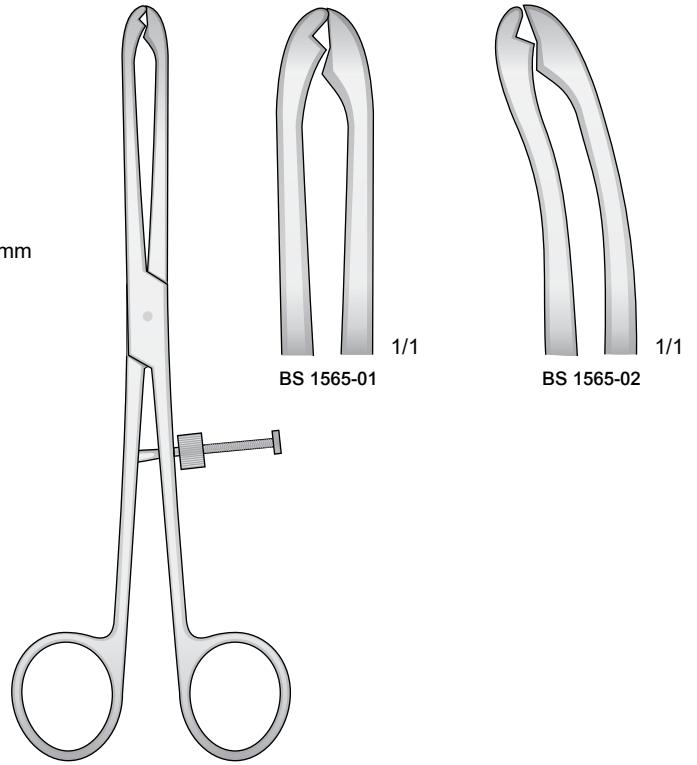

FIBULA
BS 1565-01 / BS 1565-02
 21 cm

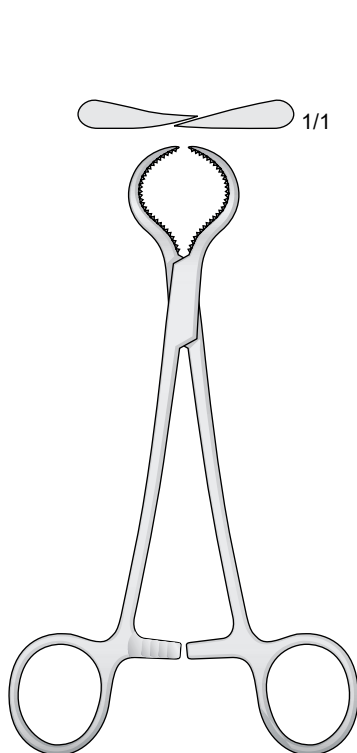

LEWIN
BS 1566-18 18 cm

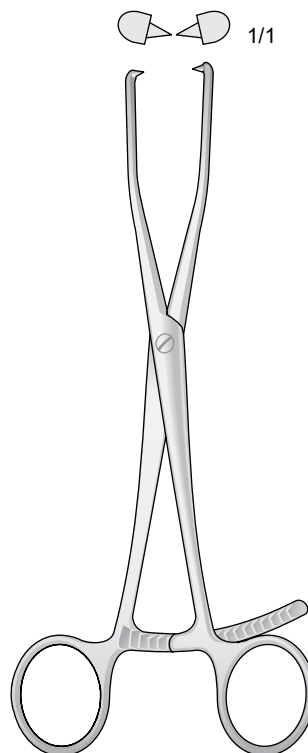

BS 1567-21 21 cm

Pinze riposizionatrici di osso - Repositionszangen
Reposition forceps - Pinzas para la reducción de dedos

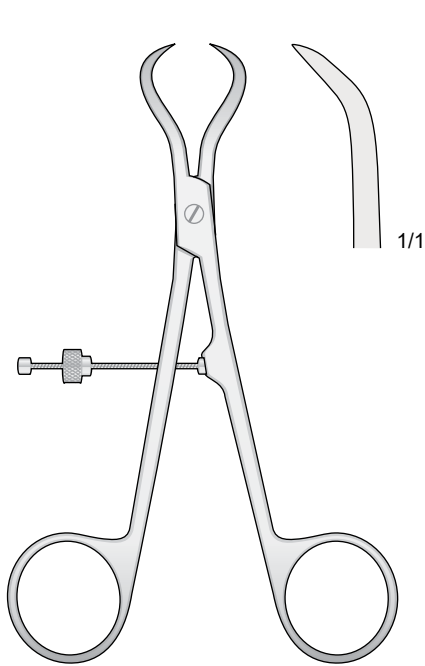

BS 1568-14 14 cm

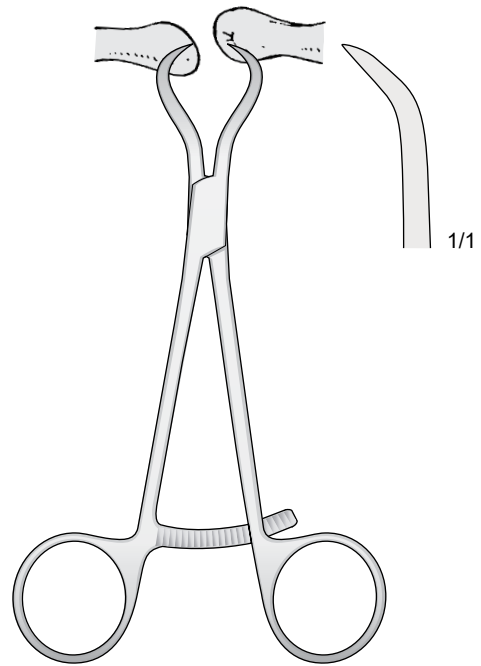

BS 1569-13 13.5 cm

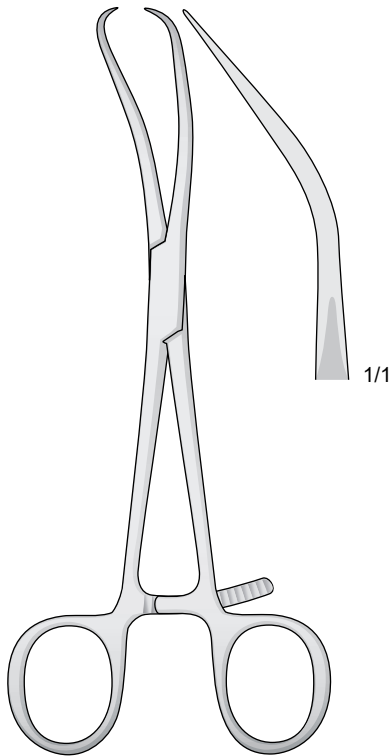

REILL
BS 1570-17 17 cm

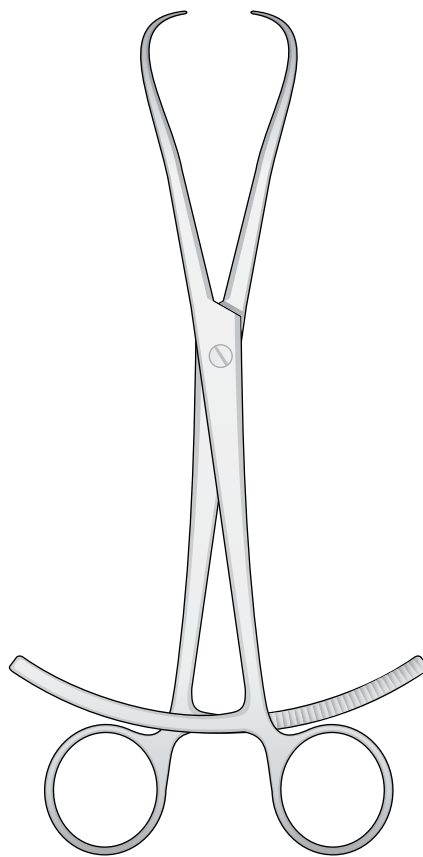

BS 1571-20 20 cm

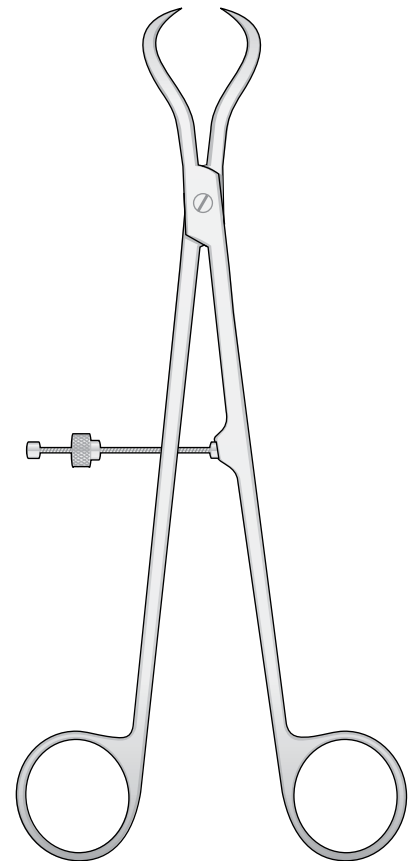

BS 1572-21 21 cm

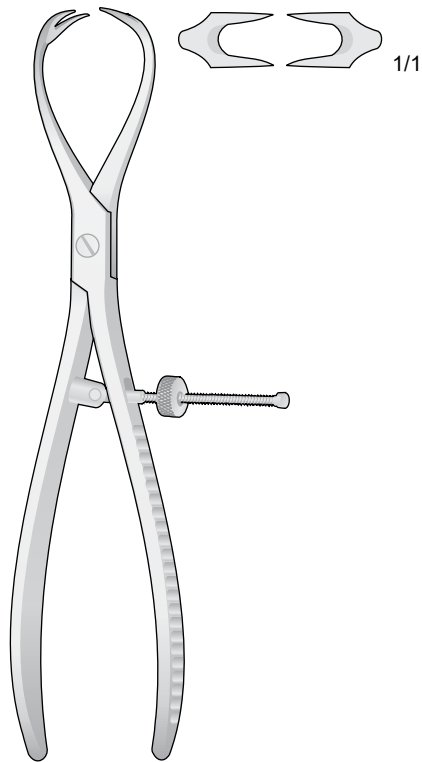

PATELLA

BS 1573-18 18.5 cm

Pinza con cremagliera
Forceps with ratchet fixation

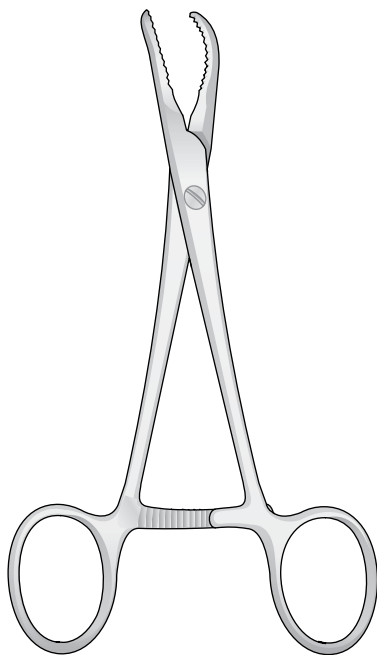

BS 1574-14 14 cm

Pinza con regolazione
Forceps with thread fixation

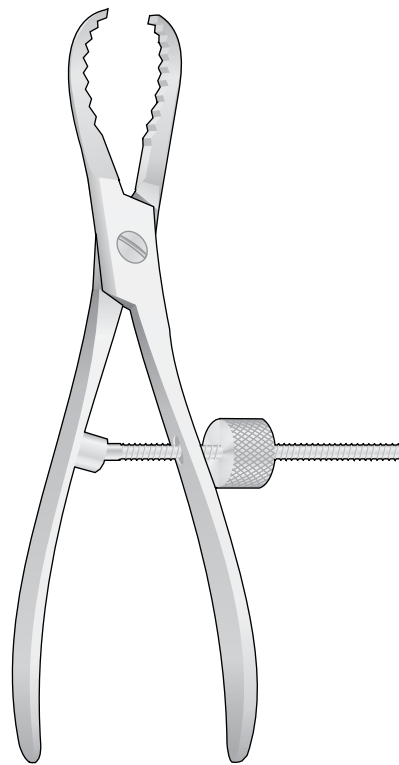

BS 1575-17 17 cm

Pinza con regolazione
Forceps with thread fixation

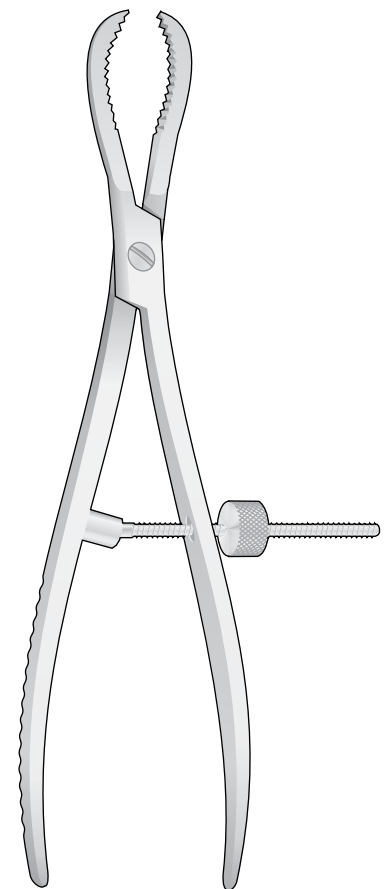

BS 1576-23 23.5 cm

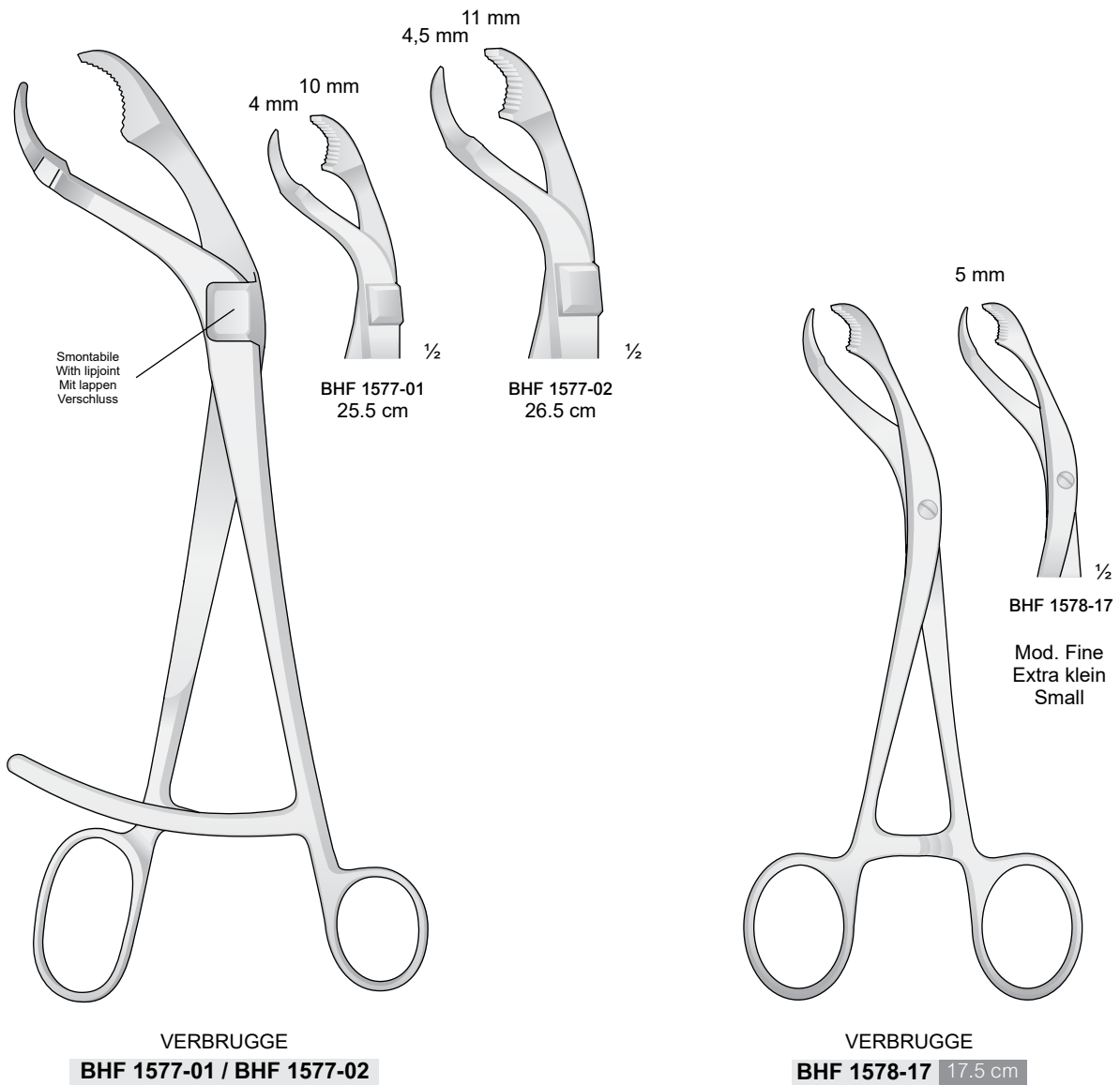

Pinze per fissazione ossea
 Bone holding forcep
 Knochenhaltenzange
 Daviers porte os
 Pinzas para huesos

Autocentrante con blocco
 Selbstzentrierend mit gewindesperre
 Self-centering bone holding forceps with thread lock

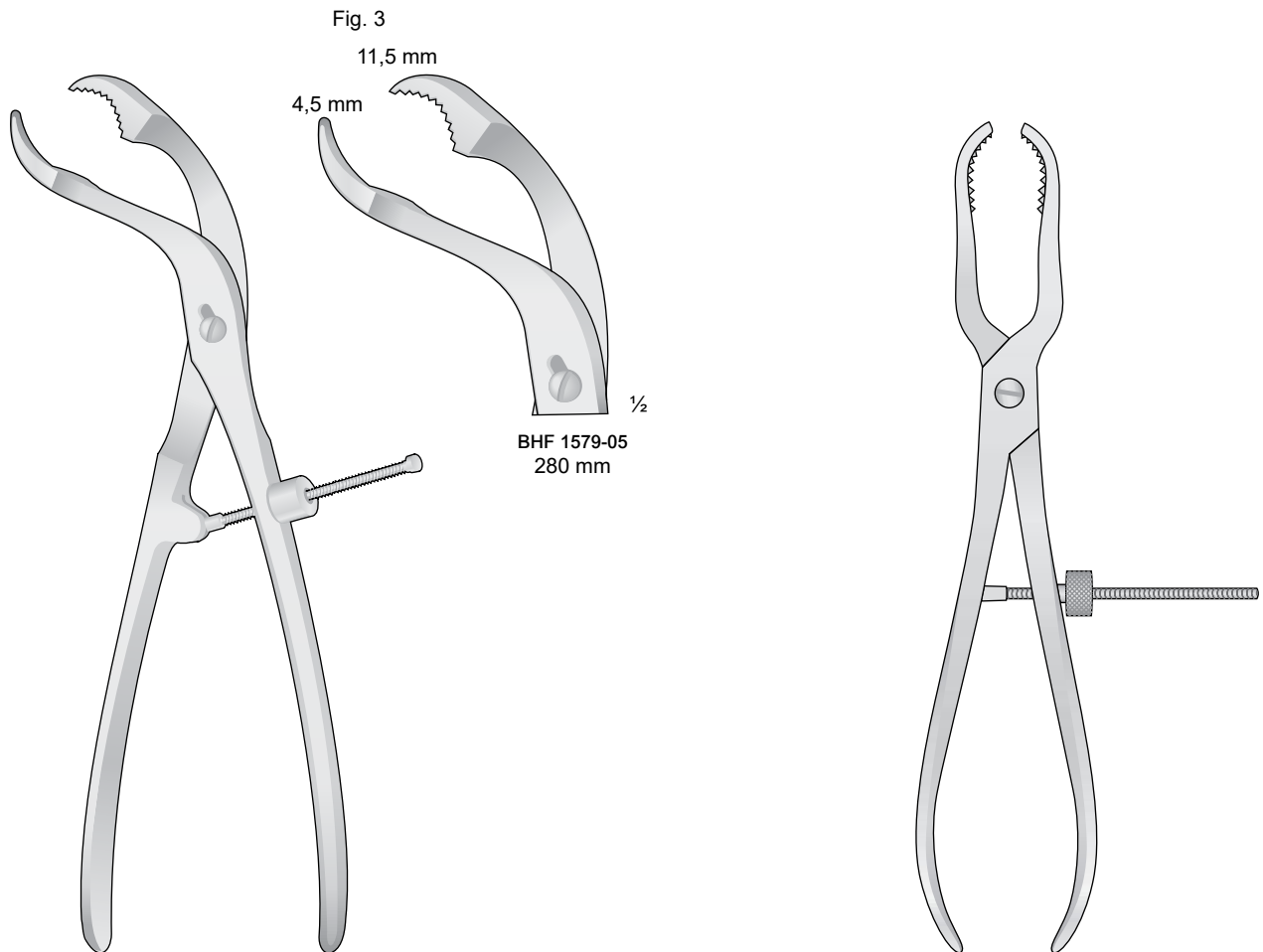
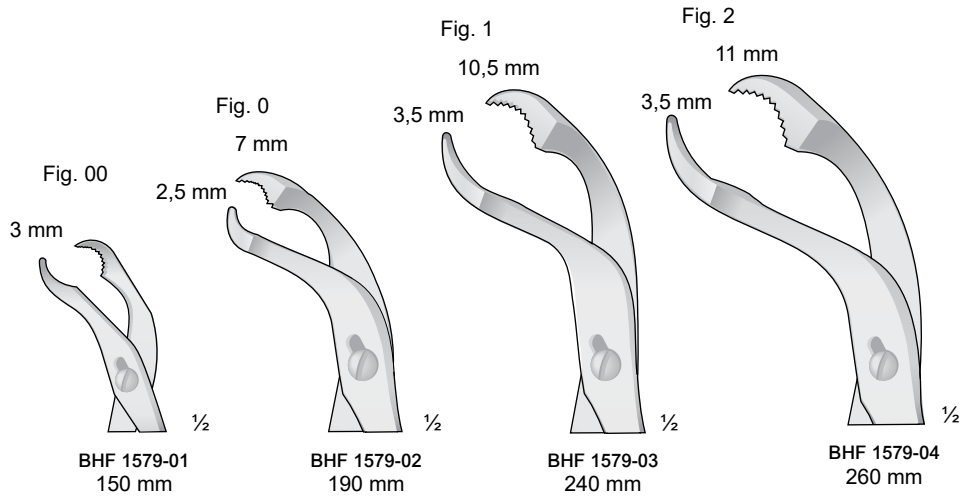

BHF 1579-01 / BHF 1579-05

BHF 1580-23 23 cm

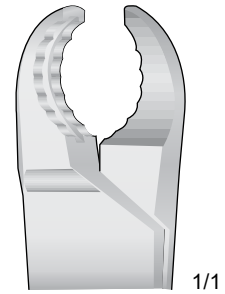

1/1

BHF 1583-23 23 cm

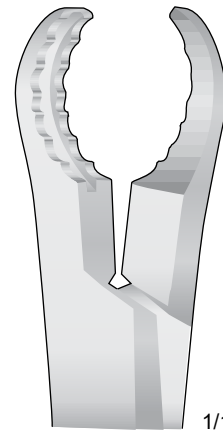

1/1

BHF 1584-25 25 cm

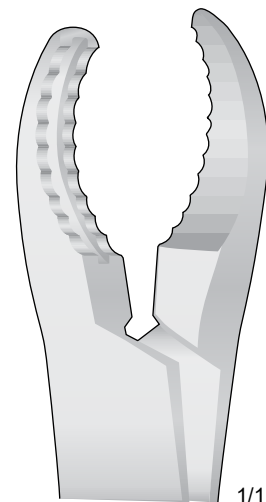

1/1

BHF 1585-28 28 cm

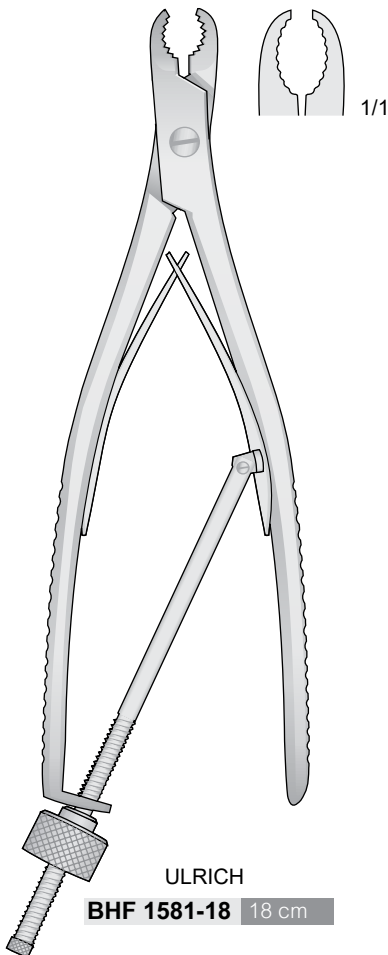

1/1

ULRICH

BHF 1581-18 18 cm

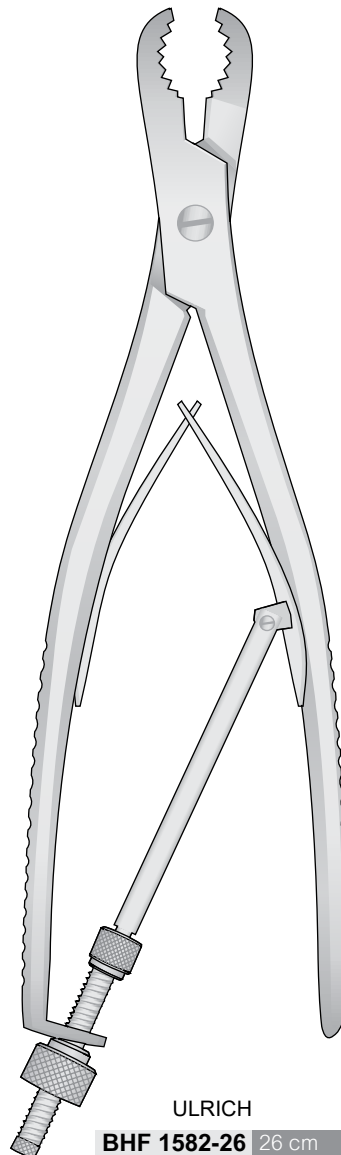

ULRICH

BHF 1582-26 26 cm

Pinza per cartilagine

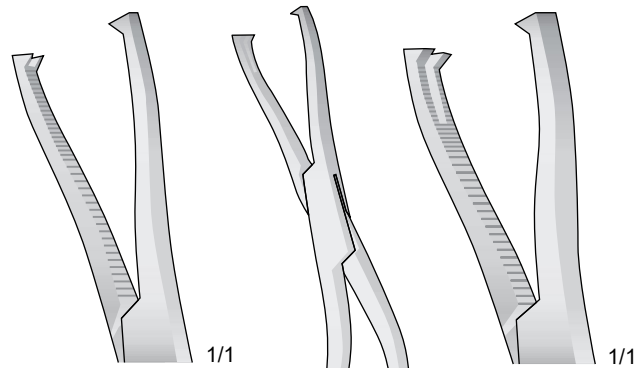

DINGMANN
BS 1586-01

DINGMANN MODIF.
BS 1586-02

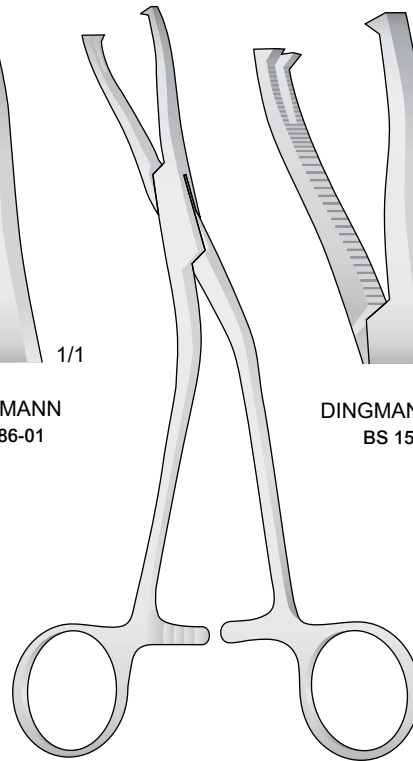

DINGMANN
BS 1586-01 / BS 1586-02
19 cm



BS 1587-18 18.5 cm

MARTIN
BS 1588-20 20 cm

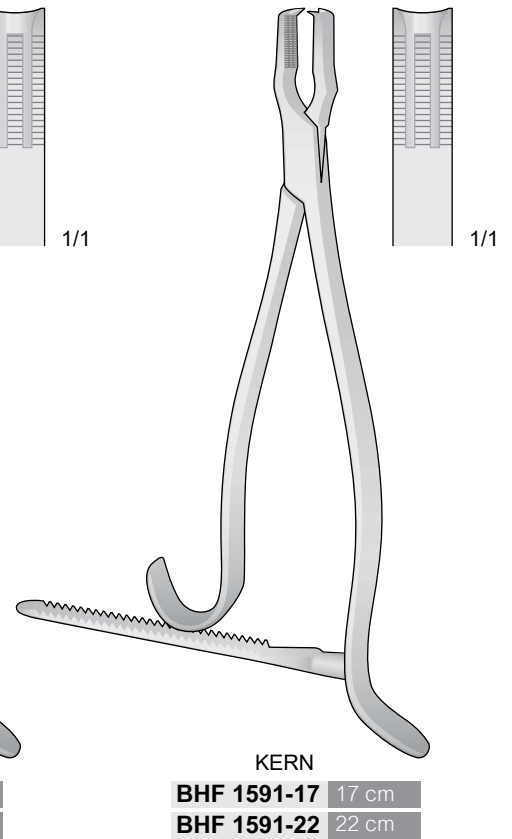
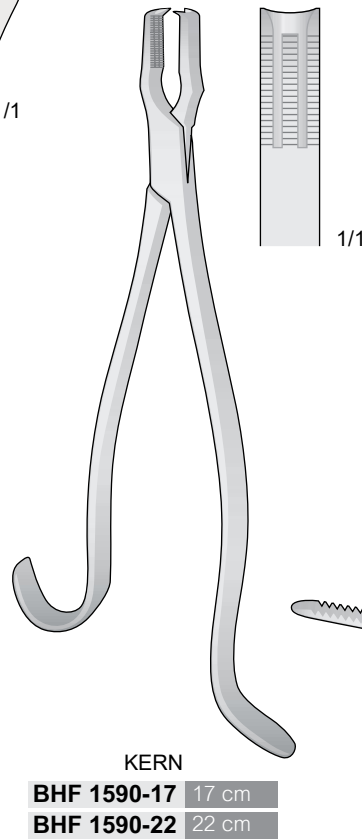
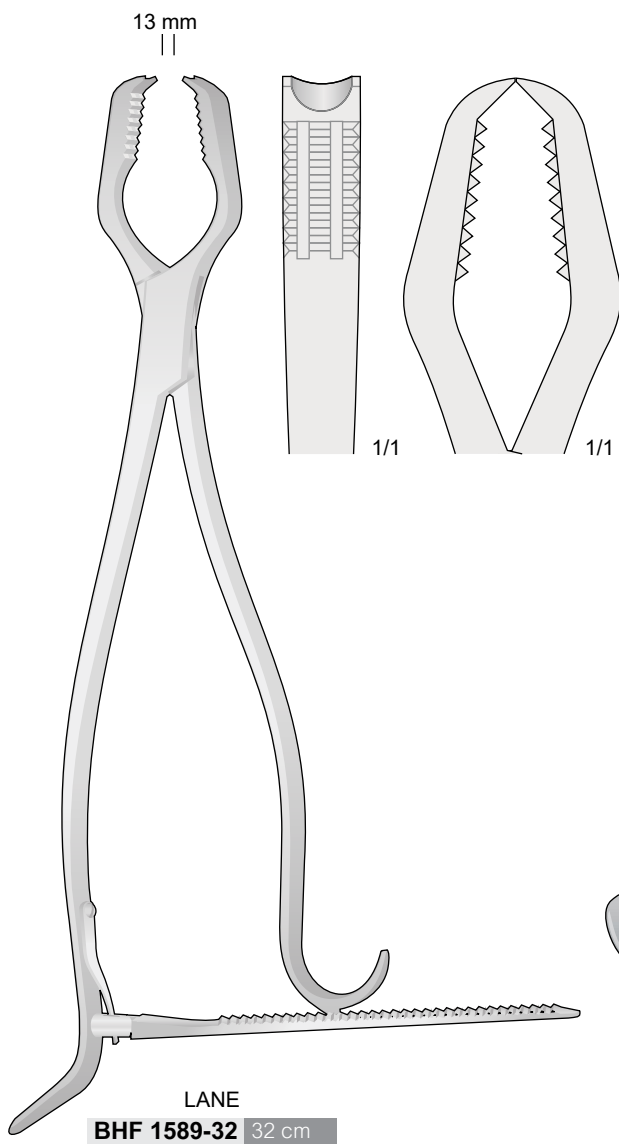

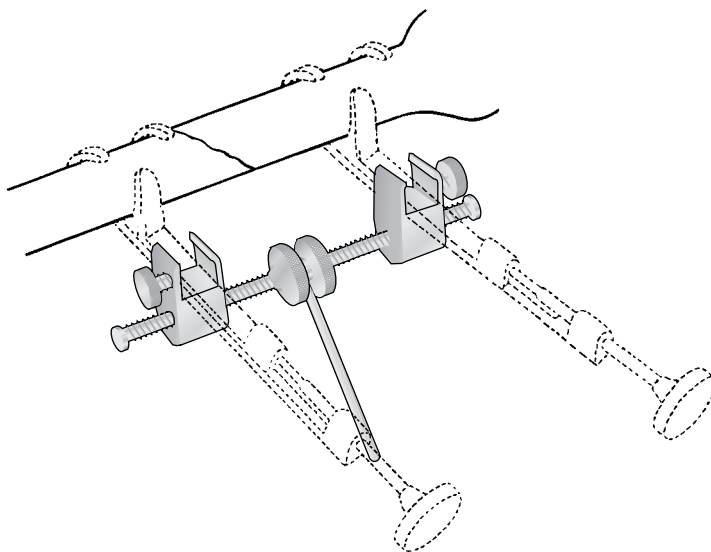

GERSTER
BS 1592

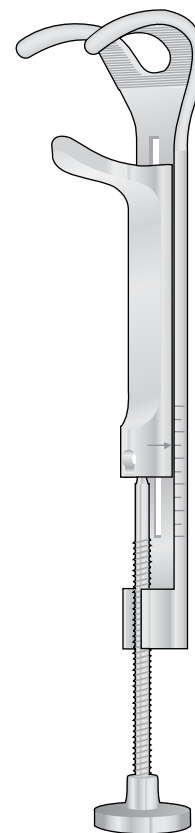

GERSTER-LOWMAN
BS 1593-12 12 cm
BS 1593-18 18.5 cm
BS 1593-20 20 cm

Per bambini
For children
Für kinder
Pour enfants
Para niños

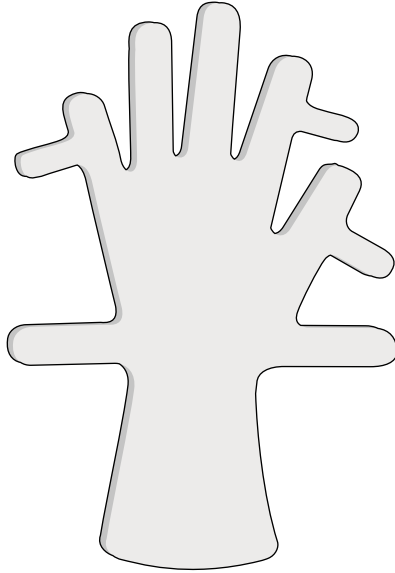

HS 1594

Per adulti - For adults - Für Erwachsene
Pour adultes - Para adultos

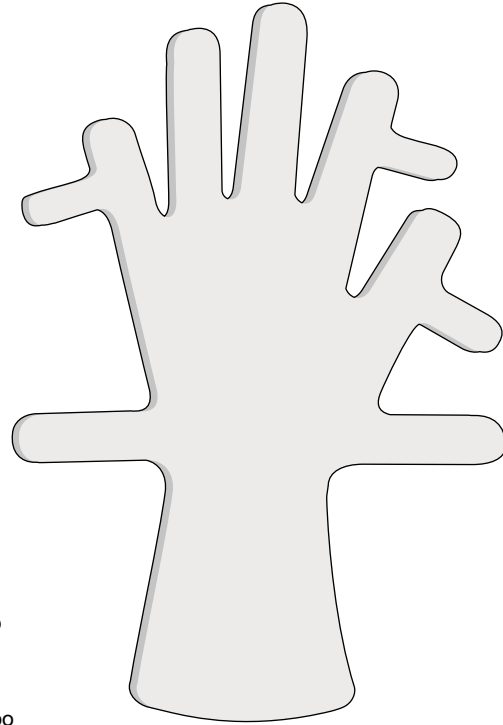

Mani di piombo
Lead hands
Bleihände
Main de plomb
Manos de plombo

HS 1595

Pinza taglia anelli - Forceps for opening rings
Fingerringsägen - Scies pour bagues - Sierra para anillos

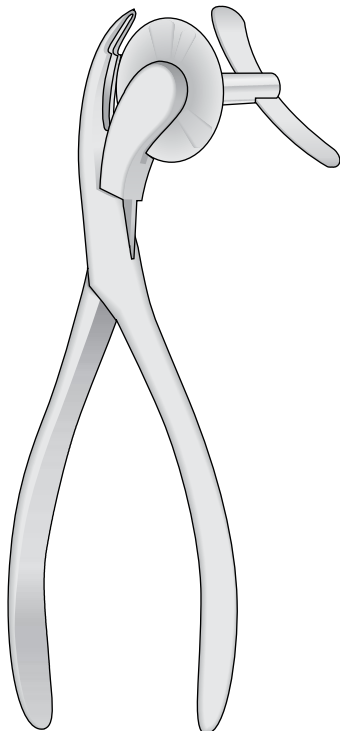

HS 1596-17 17 cm

Pinza per estrazione delle unghie
Nail extracting forceps
Nagel aus reisszange
Pince pour extraire les ongles
Pinzas para arrancar uñas

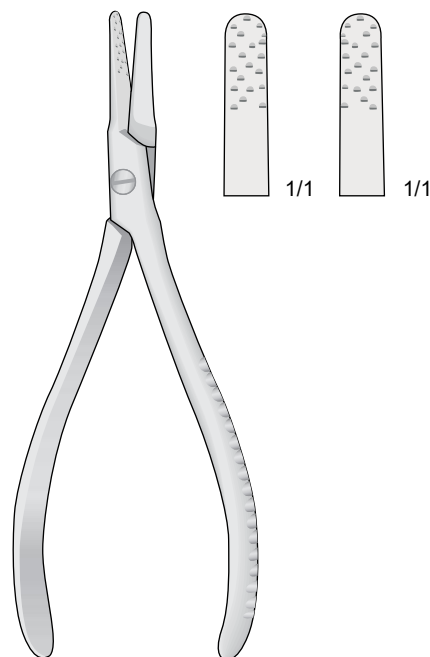

RADOLF

HS 1597-13 13.5 cm

Pinza per unghie
Nail nipper
Nagelspaltzange
Pince à ongles
Pinzas corta uñas

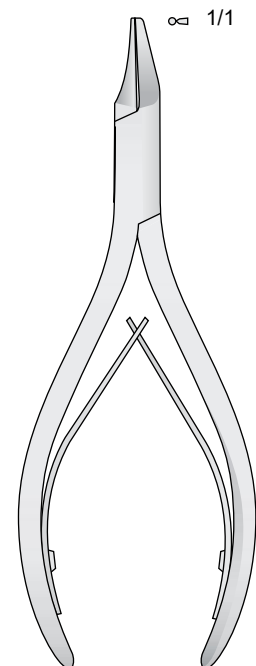

HS 1598-13 13.5 cm

Aghi per legatur
 Ligature needle
 Unterbindungsnadel
 Aiguilles à ligature
 Agujas para ligaduras

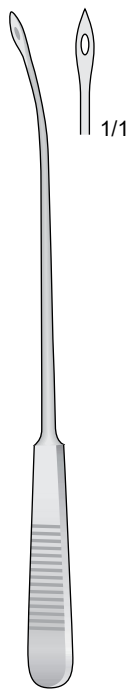

OBWEGESER
LN 1599-14 14 cm

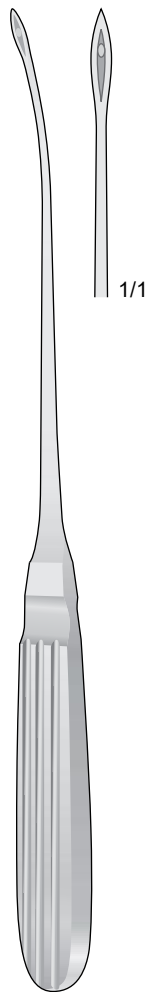

OBWEGESER
LN 1600-23 23 cm

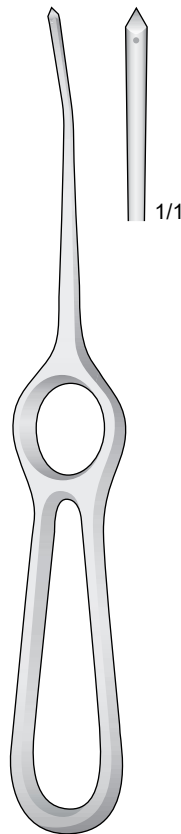

LN 1601-18 18 cm

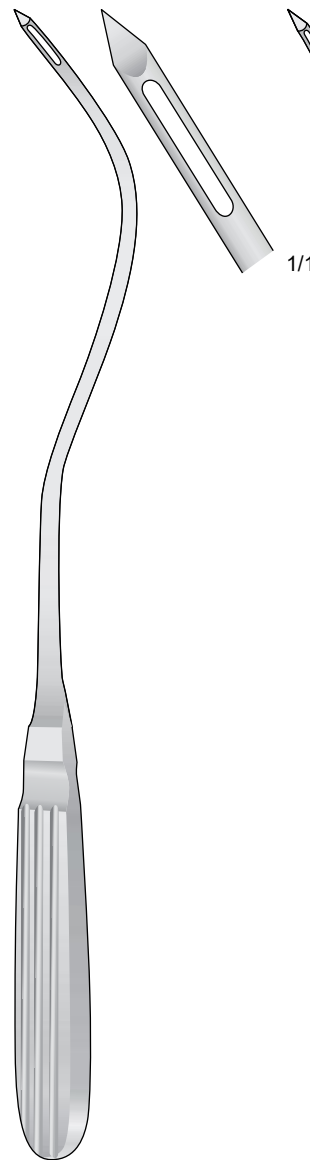

SANDERS-BROWN
LN 1602-29 29 cm

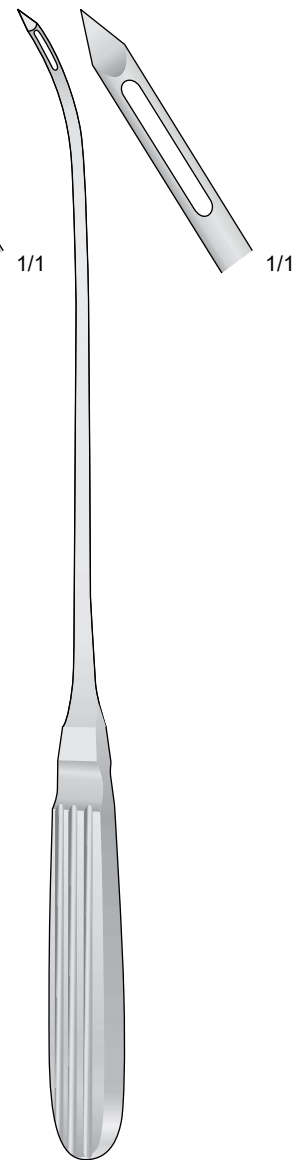

SANDERS-BROWN
LN 1603-30 30 cm

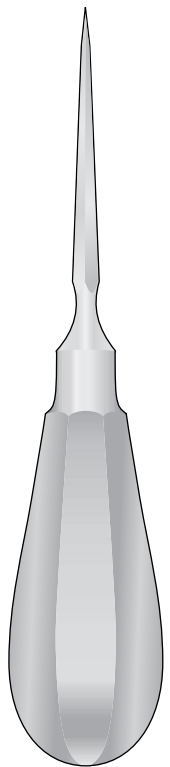

AR 1604-14 14 cm

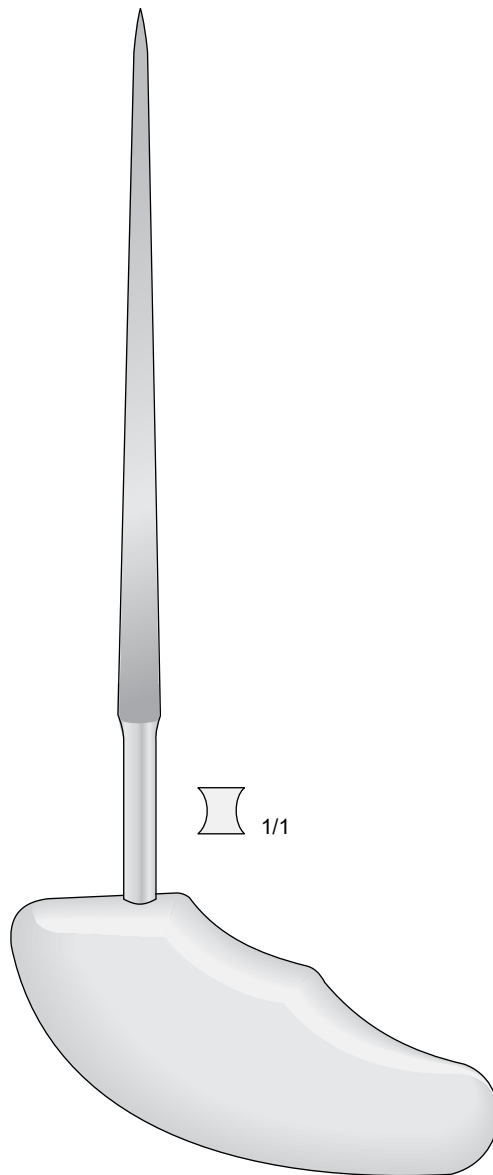

PERTHES

AR 1605-21 21 cm

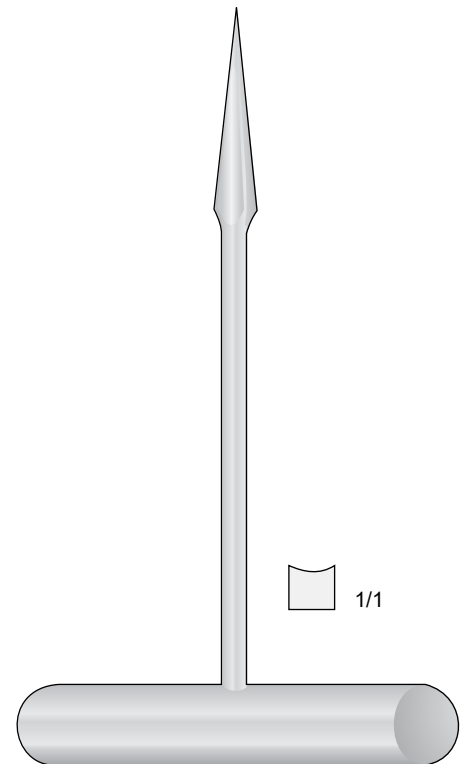





AR 1606-14 14 cm

Pinze per biopsi
 Hollow mill
 Knochenbiopsie-instrumen
 Biopsie osseuse
 Biopsia para huesos

Punche da biopsia - Hautstanzen
 Dermal punches - Trépanos cutáneos



- 
HM 1607-01
 3 mm
- 
HM 1607-02
 4 mm
- 
HM 1607-03
 5 mm
- 
HM 1607-04
 6 mm

KEYES

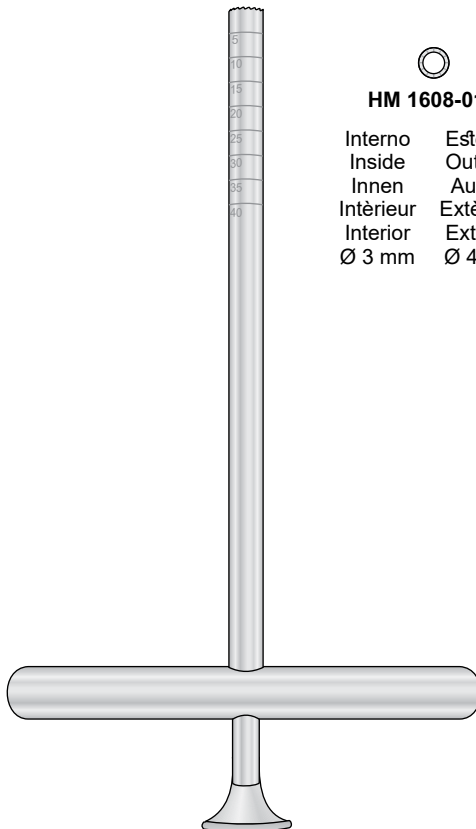

HM 1607-01 / HM 1607-02

10 cm



HM 1608-01 / HM 1608-03

17 cm

- | | | | | | | | | | | | | | | | | | | | | | | | | | | | | | | | | | | | | | | |
|--|-----------|---------|--------|---------|-------|-------|-----------|-----------|----------|----------|--------|--------|--|---------|---------|--------|---------|-------|-------|-----------|-----------|----------|----------|----------|--------|--|---------|---------|--------|---------|-------|-------|-----------|-----------|----------|----------|----------|--------|
| 
HM 1608-01
<table border="0" style="margin: auto;"> <tr><td>Interno</td><td>Ésterno</td></tr> <tr><td>Inside</td><td>Outside</td></tr> <tr><td>Innen</td><td>Außen</td></tr> <tr><td>Intérieur</td><td>Extérieur</td></tr> <tr><td>Interior</td><td>Exterior</td></tr> <tr><td>Ø 3 mm</td><td>Ø 4 mm</td></tr> </table> | Interno | Ésterno | Inside | Outside | Innen | Außen | Intérieur | Extérieur | Interior | Exterior | Ø 3 mm | Ø 4 mm | 
HM 1608-02
<table border="0" style="margin: auto;"> <tr><td>Interno</td><td>Ésterno</td></tr> <tr><td>Inside</td><td>Outside</td></tr> <tr><td>Innen</td><td>Außen</td></tr> <tr><td>Intérieur</td><td>Extérieur</td></tr> <tr><td>Interior</td><td>Exterior</td></tr> <tr><td>Ø 3,9 mm</td><td>Ø 5 mm</td></tr> </table> | Interno | Ésterno | Inside | Outside | Innen | Außen | Intérieur | Extérieur | Interior | Exterior | Ø 3,9 mm | Ø 5 mm | 
HM 1608-03
<table border="0" style="margin: auto;"> <tr><td>Interno</td><td>Ésterno</td></tr> <tr><td>Inside</td><td>Outside</td></tr> <tr><td>Innen</td><td>Außen</td></tr> <tr><td>Intérieur</td><td>Extérieur</td></tr> <tr><td>Interior</td><td>Exterior</td></tr> <tr><td>Ø 6,4 mm</td><td>Ø 8 mm</td></tr> </table> | Interno | Ésterno | Inside | Outside | Innen | Außen | Intérieur | Extérieur | Interior | Exterior | Ø 6,4 mm | Ø 8 mm |
| Interno | Ésterno | | | | | | | | | | | | | | | | | | | | | | | | | | | | | | | | | | | | | |
| Inside | Outside | | | | | | | | | | | | | | | | | | | | | | | | | | | | | | | | | | | | | |
| Innen | Außen | | | | | | | | | | | | | | | | | | | | | | | | | | | | | | | | | | | | | |
| Intérieur | Extérieur | | | | | | | | | | | | | | | | | | | | | | | | | | | | | | | | | | | | | |
| Interior | Exterior | | | | | | | | | | | | | | | | | | | | | | | | | | | | | | | | | | | | | |
| Ø 3 mm | Ø 4 mm | | | | | | | | | | | | | | | | | | | | | | | | | | | | | | | | | | | | | |
| Interno | Ésterno | | | | | | | | | | | | | | | | | | | | | | | | | | | | | | | | | | | | | |
| Inside | Outside | | | | | | | | | | | | | | | | | | | | | | | | | | | | | | | | | | | | | |
| Innen | Außen | | | | | | | | | | | | | | | | | | | | | | | | | | | | | | | | | | | | | |
| Intérieur | Extérieur | | | | | | | | | | | | | | | | | | | | | | | | | | | | | | | | | | | | | |
| Interior | Exterior | | | | | | | | | | | | | | | | | | | | | | | | | | | | | | | | | | | | | |
| Ø 3,9 mm | Ø 5 mm | | | | | | | | | | | | | | | | | | | | | | | | | | | | | | | | | | | | | |
| Interno | Ésterno | | | | | | | | | | | | | | | | | | | | | | | | | | | | | | | | | | | | | |
| Inside | Outside | | | | | | | | | | | | | | | | | | | | | | | | | | | | | | | | | | | | | |
| Innen | Außen | | | | | | | | | | | | | | | | | | | | | | | | | | | | | | | | | | | | | |
| Intérieur | Extérieur | | | | | | | | | | | | | | | | | | | | | | | | | | | | | | | | | | | | | |
| Interior | Exterior | | | | | | | | | | | | | | | | | | | | | | | | | | | | | | | | | | | | | |
| Ø 6,4 mm | Ø 8 mm | | | | | | | | | | | | | | | | | | | | | | | | | | | | | | | | | | | | | |

BI 1609
Set completo di 4 pezzi
Set complete with 4 pieces
Komplettset mit 4 Teilen
Set complet avec 4 pièces
Set completo con 4 piezas

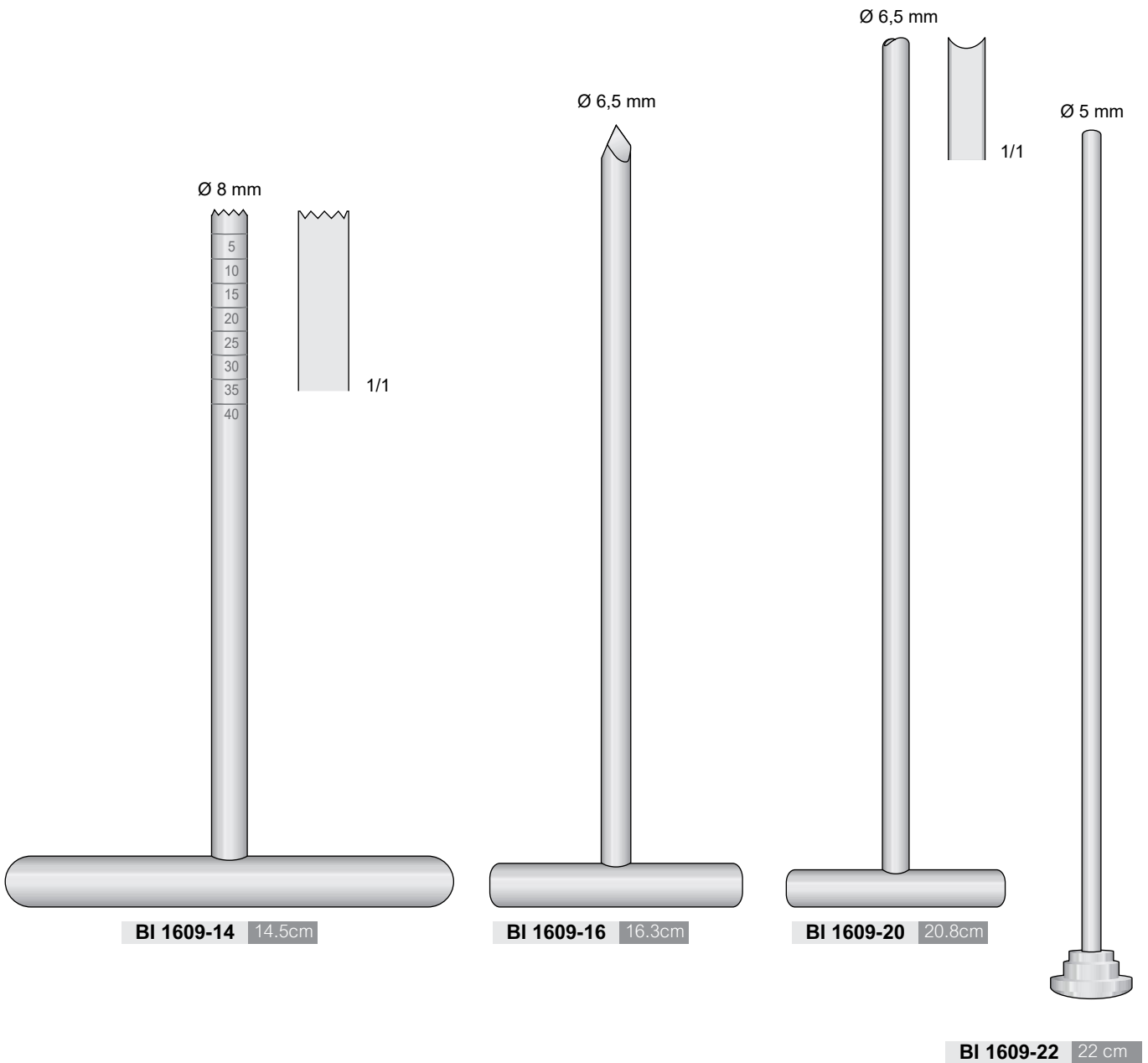

BI 1610

Set completo di 4 pezzi
Set complete with 4 pieces
Kompletset mit 4 Teilen
Set complet avec 4 pièces
Set completo con 4 piezas

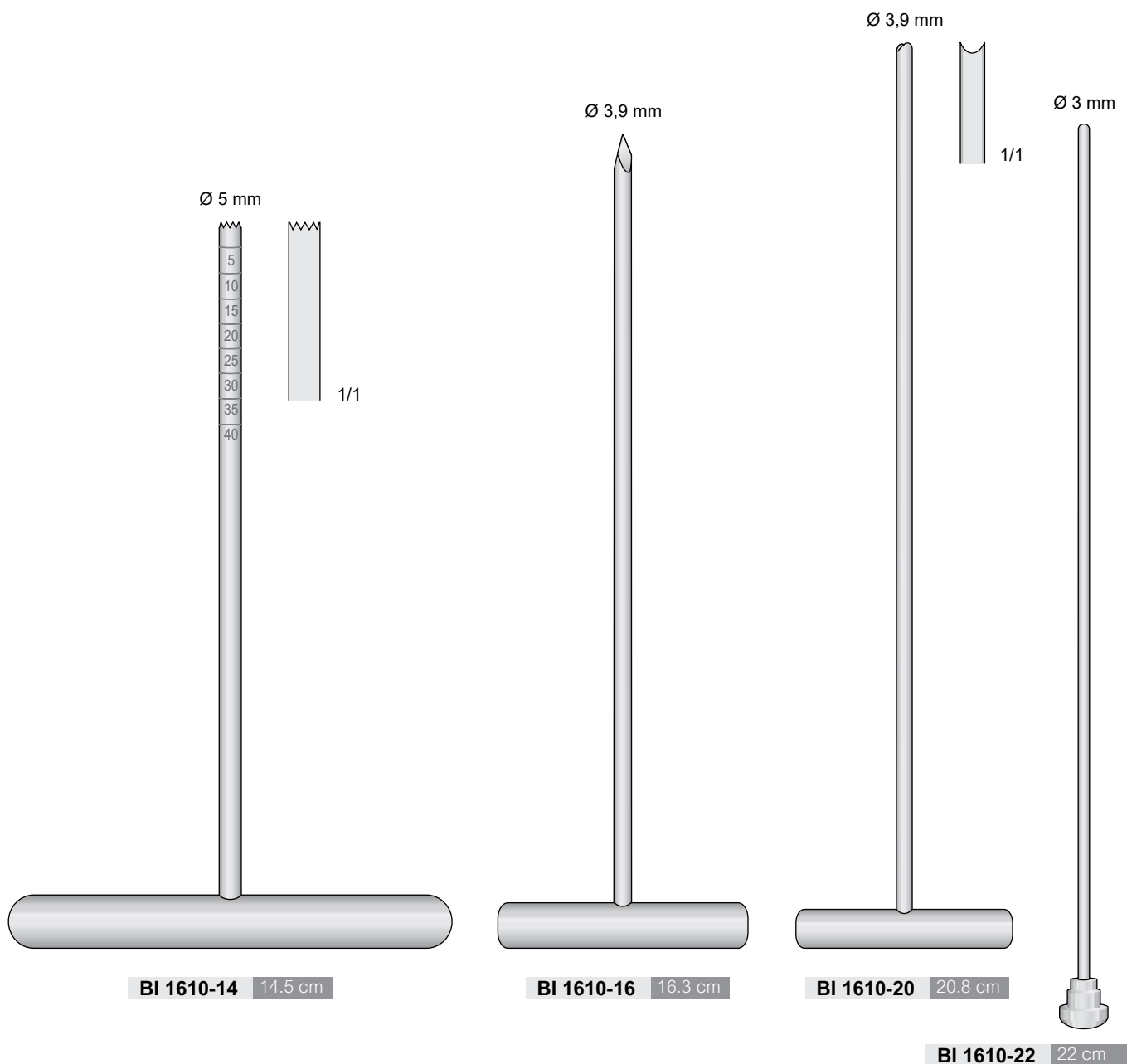



KIRSCHNER
Punta trequarti
Trocar point
Trokarspitze
Pointe de Trocart
Punta de tròcar



KIRSCHNER
Punta trequarti
Trocar point
Trokarspitze
Pointe de Trocart
Punta de tròcar



KIRSCHNER
Punte lanceolate
Lance point
Lanzenspitze
Pointe lancette
Punta lanceolar

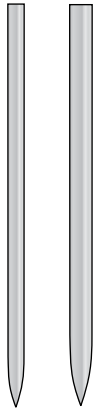

Punta trequarti
Trocar point
Trokarspitze
Pointe de Trocart
Punta de tròcar

310 mm

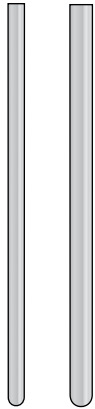

Punta rotonda
Round shaft
Rundes ende
Pointe ronde
Punta redonda

310 mm

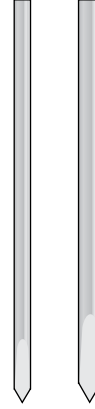

Punte lanceolate
Lance point
Lanzenspitze
Pointe lancette
Punta lanceolar

310 mm

Ø/Diam.	Conf. 10 pz.
0,8 mm	WE 1611-01
1,0 mm	WE 1611-02
1,2 mm	WE 1611-03
1,4 mm	WE 1611-04
1,5 mm	WE 1611-05
1,6 mm	WE 1611-06
1,7 mm	WE 1611-07
1,8 mm	WE 1611-08
2,0 mm	WE 1611-09
2,2 mm	WE 1611-10
2,5 mm	WE 1611-11
3,0 mm	WE 1611-12

Ø/Diam.	Conf. 10 pz.
0,8 mm	WE 1612-01
1,0 mm	WE 1612-02
1,2 mm	WE 1612-03
1,4 mm	WE 1612-04
1,5 mm	WE 1612-05
1,6 mm	WE 1612-06
1,7 mm	WE 1612-07
1,8 mm	WE 1612-08
2,0 mm	WE 1612-09
2,2 mm	WE 1612-10
2,5 mm	WE 1612-11
3,0 mm	WE 1612-12

Ø/Diam.	Conf. 10 pz.
0,8 mm	WE 1613-01
1,0 mm	WE 1613-02
1,2 mm	WE 1613-03
1,5 mm	WE 1613-04
1,6 mm	WE 1613-05
1,8 mm	WE 1613-06
2,0 mm	WE 1613-07
2,2 mm	WE 1613-08
2,5 mm	WE 1613-09
3,0 mm	WE 1613-10

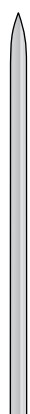

KIRSCHNER
 Punta tre quarti
 Trocar point
 Trokarspitze
 Pointe de Trocart
 Punta de tròcar



KIRSCHNER
 Punta tre quarti
 Trocar point
 Trokarspitze
 Pointe de Trocart
 Punta de tròcar



15 mm

Con filettatura
 With thread
 Mit gewinde
 Avec filetage
 Con rosca

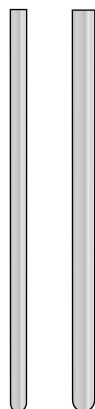

Punta rotonda
 Round shaft
 Rundes ende
 Pointe ronde
 Punta redonda

150 mm



Punta tre quarti
 Trocar point
 Trokarspitze
 Pointe de Trocart
 Punta de tròcar

150 mm



Rotonda
 Round
 Runde
 Ronde
 Redonda

○

Ø/Diam.	Conf. 10 pz.
0,8 mm	WE 1614-01
1,0 mm	WE 1614-02
1,2 mm	WE 1614-03
1,4 mm	WE 1614-04
1,5 mm	WE 1614-05
1,6 mm	WE 1614-06
1,7 mm	WE 1614-07
1,8 mm	WE 1614-08
2,0 mm	WE 1614-09
2,2 mm	WE 1614-10
2,5 mm	WE 1614-11
3,0 mm	WE 1614-12

Ø/Diam.	Conf. 10 pz.
0,8 mm	WE 1615-01
1,0 mm	WE 1615-02
1,2 mm	WE 1615-03
1,4 mm	WE 1615-04
1,6 mm	WE 1615-05

KIRSCHNER			
Codice	Ø mm	Lung.	Lung. filo
WE 1616-01	1,5	150	5
WE 1616-02	1,6	150	15
WE 1616-03	2	150	15
WE 1616-04	2	200	15

KIRSCHNER

Bundel-Nagel

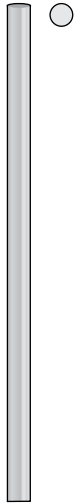

500 mm

Steinmann pins



310 mm

Küntscher

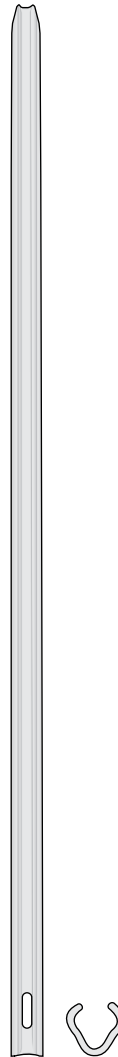

400 mm

Threaded Steinmann Pins



230 mm

Runde

Ø/Diam.	Conf. 10 pz.
2,0 mm	WE 1617-01
2,5 mm	WE 1617-02
3,0 mm	WE 1617-03
3,5 mm	WE 1617-04
4,0 mm	WE 1617-05
4,5 mm	WE 1617-06
5,0 mm	WE 1617-07
5,5 mm	WE 1617-08
6,0 mm	WE 1617-09

Ø/Diam.	Conf. 1 pz.
3,5 mm	WE 1618-01
4,0 mm	WE 1618-02
4,5 mm	WE 1618-03
5,0 mm	WE 1618-04
6,0 mm	WE 1618-05
6,5 mm	WE 1618-06

Ø/Diam.	Conf. 1 pz.
6,0 mm	WE 1619-01
7,0 mm	WE 1619-02
8,0 mm	WE 1619-03
9,0 mm	WE 1619-04
10 mm	WE 1619-05
11 mm	WE 1619-06
12 mm	WE 1619-07

Ø/Diam.	Conf. 1 pz.
2,0 mm	WE 1620-01
2,5 mm	WE 1620-02

Chiodi filettati Schanz
 Threaded Wires and pines
 Bohrdrähte und Knochennägel mit Gewinde
 Broches et clous avec filetage
 Agujas y clavos con rosca

Steinmann Pins with Central Thread with Trocar Point

Contenitore per
 sterilizzazione Kirschner
 Bohrdrahtspender



Positivo
 Thread - Ø is 0,5 mm
 more than pin - Ø

3 Kant



STEINMANN PINS			
Codice	Ø mm	Lung.	Lung. Filo mm
TWP 1621-01	3	150	37
TWP 1621-02	3	180	48
TWP 1621-03	3	200	50
TWP 1621-04	3	230	52
TWP 1621-05	3,5	150	37
TWP 1621-06	3,5	180	52
TWP 1621-07	3,5	200	52
TWP 1621-08	3,5	230	52
TWP 1621-09	4	150	37
TWP 1621-10	4	180	52
TWP 1621-11	4	200	50
TWP 1621-12	4	230	52
TWP 1621-13	4	250	52
TWP 1621-14	4,5	150	37
TWP 1621-15	4,5	180	52
TWP 1621-16	4,5	200	52
TWP 1621-17	4,5	230	52
TWP 1621-18	4,5	250	52
TWP 1621-19	4,5	300	52
TWP 1621-20	5	150	37
TWP 1621-21	5	180	52
TWP 1621-22	5	200	50
TWP 1621-23	5	230	52
TWP 1621-24	5	250	52
TWP 1621-25	5	300	52

Ø 10 mm

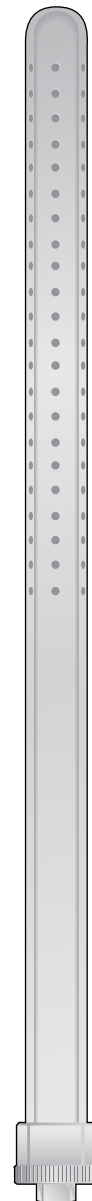

Ø 10 mm

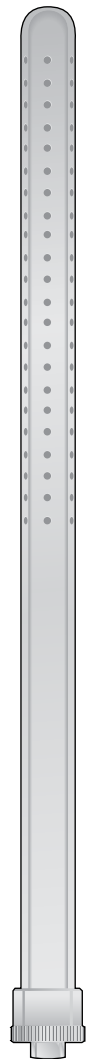

TWP 1621-01 / TWP 1621-25

TWP 1622-32 32 cm TWP 1623-19 19 cm



Viti di Schanz
 Schanz screws
 Schanz'sche Schrauben
 Vis de Schanz

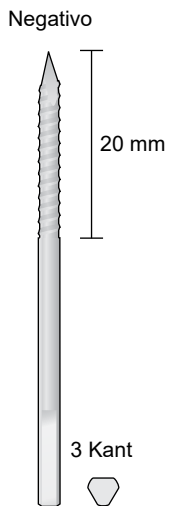

SCHANZ			
Codice	Ø mm	Lung.	Lung. filo
TWP 1624-01	3	60	20
TWP 1624-02	3	80	20
TWP 1624-03	4	60	25

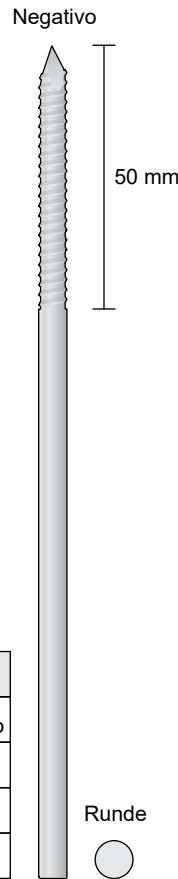

SCHANZ			
Codice	Ø mm	Lung.	Lung. filo
TWP 1625-01	2	150	50
TWP 1625-02	3	150	50
TWP 1625-03	3,5	150	50
TWP 1625-04	4	150	50
TWP 1625-05	4,5	150	50
TWP 1625-06	5	150	50

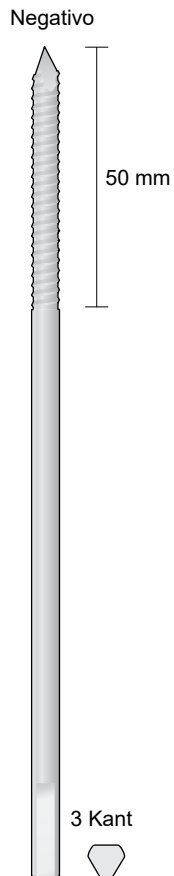

SCHANZ			
Codice	Ø mm	Lung.	Lung. filo
TWP 1626-01	2	150	50
TWP 1626-02	3	150	50
TWP 1626-03	3,5	150	50
TWP 1626-04	4	150	50
TWP 1626-05	4,5	150	50
TWP 1626-06	5	150	50

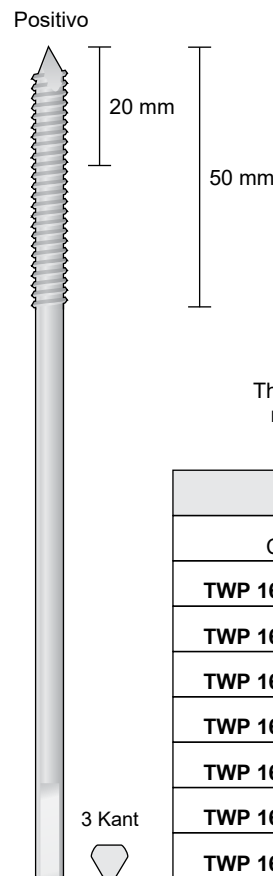

SCHANZ			
Codice	Ø mm	Lung.	Lung. filo
TWP 1627-01	2	150	20
TWP 1627-02	3	150	20
TWP 1627-03	3,5	150	50
TWP 1627-04	4	150	25
TWP 1627-05	4	150	50
TWP 1627-06	4,5	150	50
TWP 1627-07	5	150	50

Thread - Ø is 0,5 mm
 more than pin - Ø

Strumenti per filo di cerchiaggio
 Wire instrument set
 Drahtinstrumentarium
 Instruments à fil
 Instrumental para cerclaje

Filo malleabile
 per compattare l'osso
 Wire soft
 Draht weich
 Fil à os
 Alambre ligadura



10 mt.

Ø/Diam.	Codice
0,2 mm	BS 1628-01
0,3 mm	BS 1628-02
0,4 mm	BS 1628-03
0,5 mm	BS 1628-04
0,6 mm	BS 1628-05
0,7 mm	BS 1628-06
0,8 mm	BS 1628-07
0,9 mm	BS 1628-08
1,0 mm	BS 1628-09
1,2 mm	BS 1628-10
1,5 mm	BS 1628-11

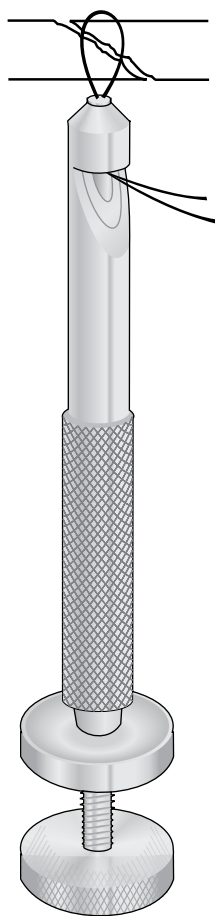

LOUTE

BS 1629-22 22 cm

Strumenti tendifili
 Bone wire tighteners
 Drahtspanninstrument
 Tendeur serre fils
 Tensor cierra-hilos

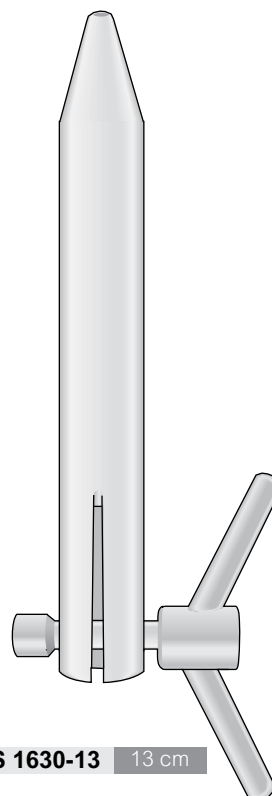

BS 1630-13 13 cm

Fino a Ø 3 mm
Bis Ø 3 mm
Up to Ø 3 mm

Gancio d'estrazione
Extraction hooks
Extraktions haken
Crochets d'extraction
Ganchos extractores

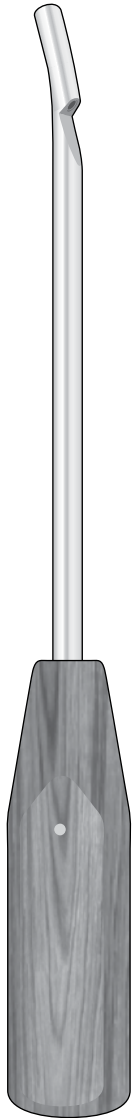

WAGNER
BS 1631-30 30 cm

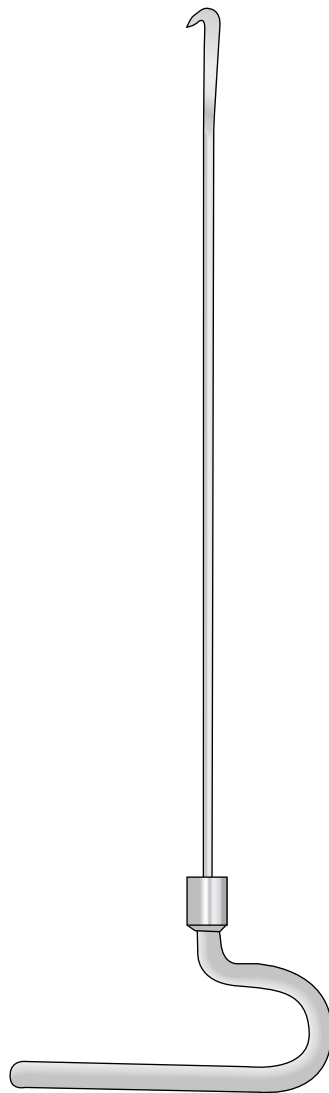

BS 1632-29 29 cm
BS 1632-37 37 cm
BS 1632-24 42 cm



BS 1633-12 12 cm



KÜNTSCHER
BS 1634-21 21 cm

DC 1640
 Completo con - Complete with
 Komplett mit - Completes avec
 Completos con:
 1 **DC 1637-05**
 1 **DC 1638-05**
 1 **DC 1639-08**

Attacco AO

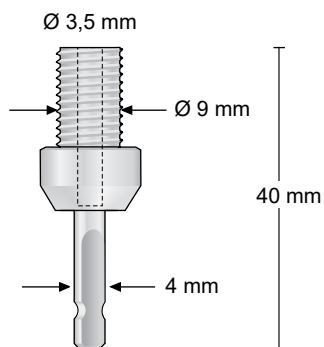

DC 1635-04 40 mm

Inox
 ORIGINAL JACOBS

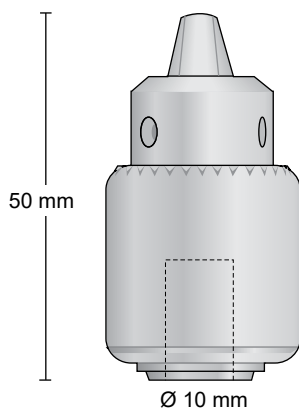

DC 1637-05 50 mm

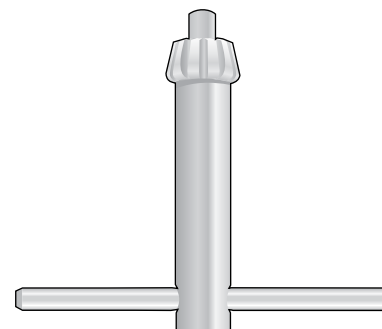

DC 1638-05 52 mm

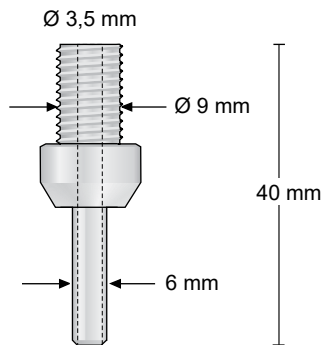

DC 1636-04 40 mm

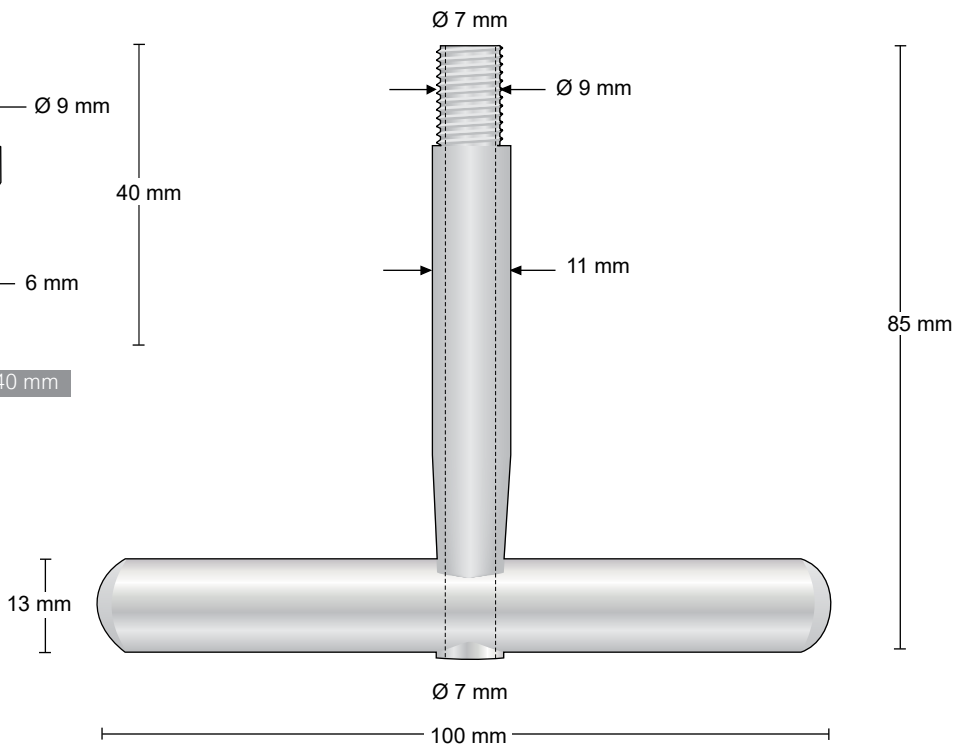

DC 1639-08 85 mm

DC 1645
Completo con - Complete with
Komplett mit - Completes avec
Completo con:
1 **DC 1641-05**
1 **DC 1642-05**
1 **DC 1643-09**
1 **DC 1644-13**

Inox
ORIGINAL JACOBS

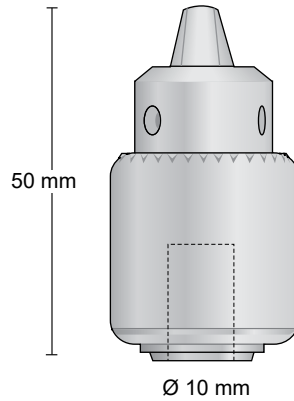

DC 1641-05 50 mm

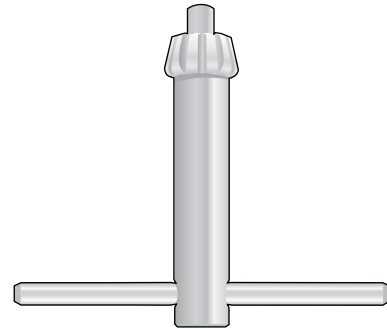

DC 1642-05 52 mm

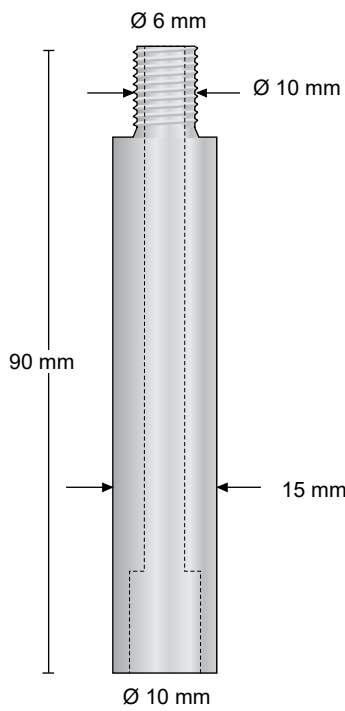

DC 1643-09 90 mm

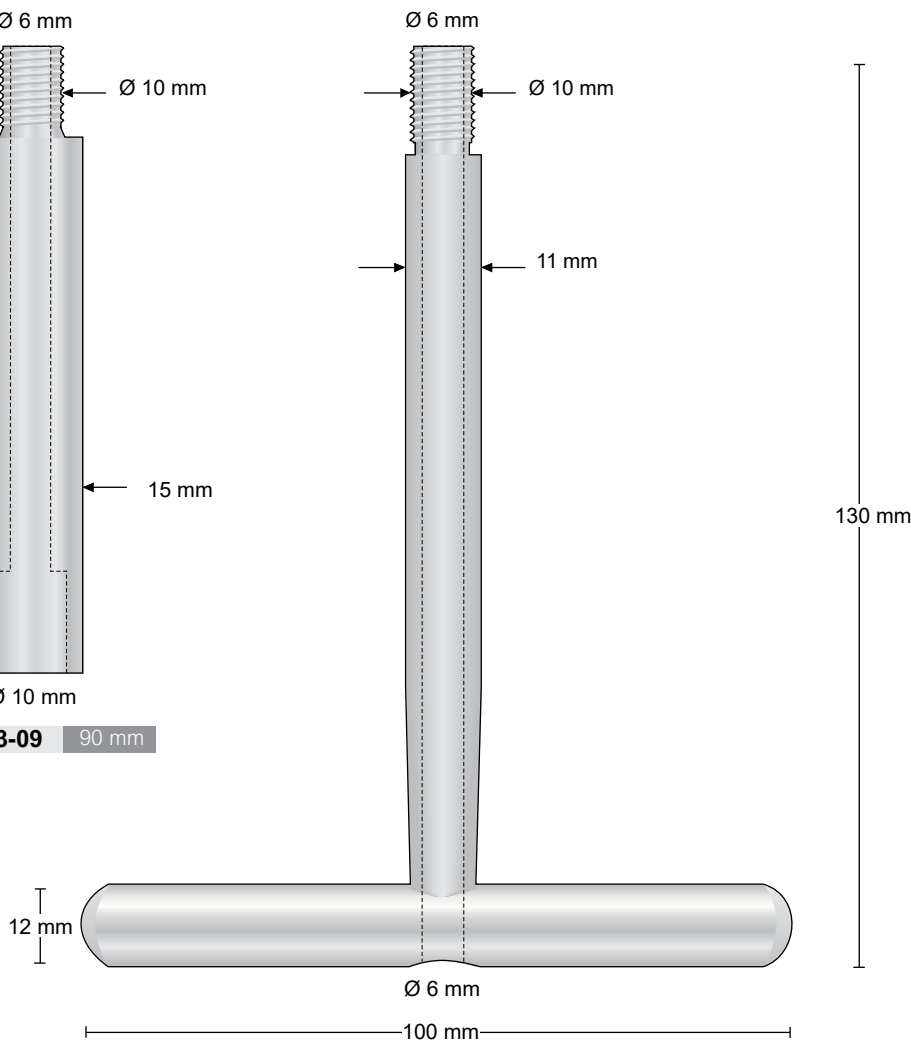

DC 1644-13 130 mm

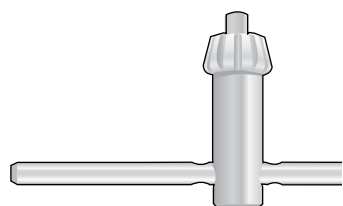

DC 1646-03 32 mm

Inox
Ap. 7 mm

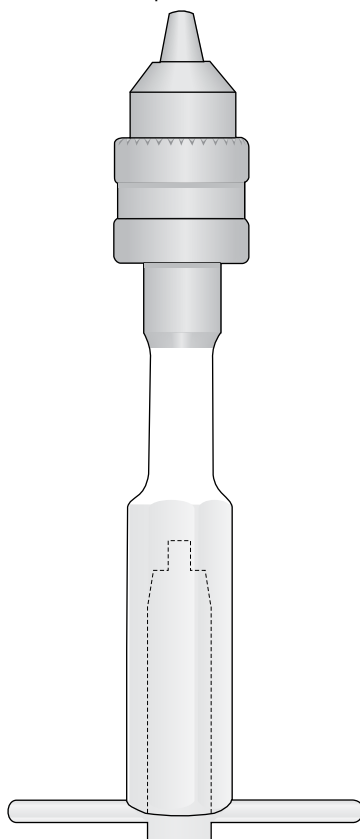

DC 1647-13 13 cm

Con chiusura a mano
Von Hand zu spannen
tightened by hand

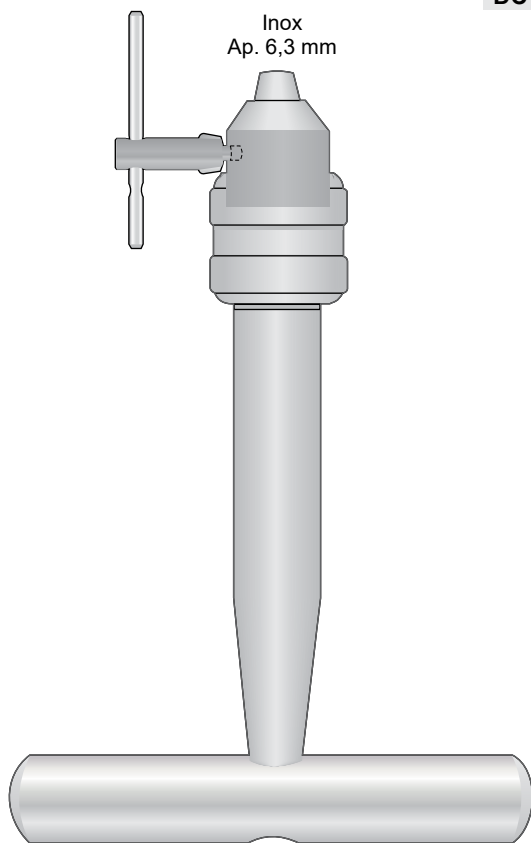

Inox
Ap. 6,3 mm

DC 1648-13 13 cm

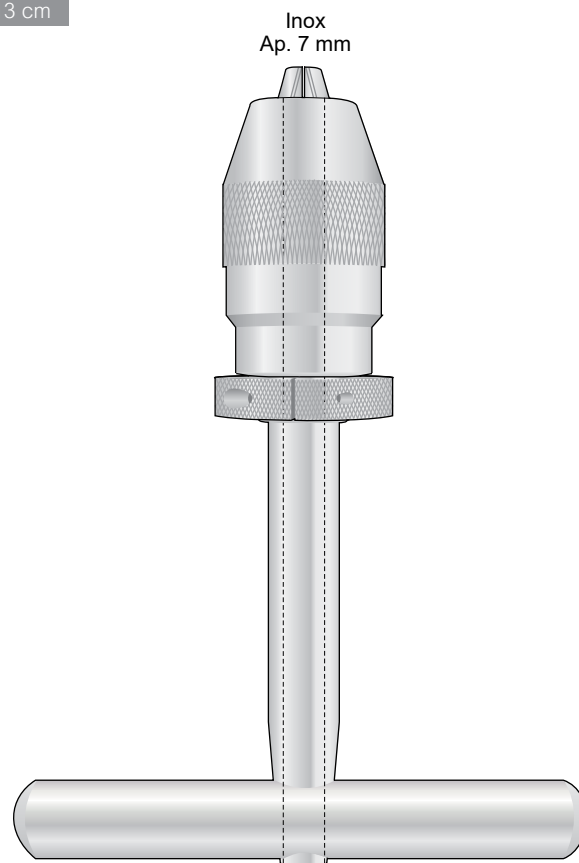

Inox
Ap. 7 mm

DC 1649-13 13.5 cm

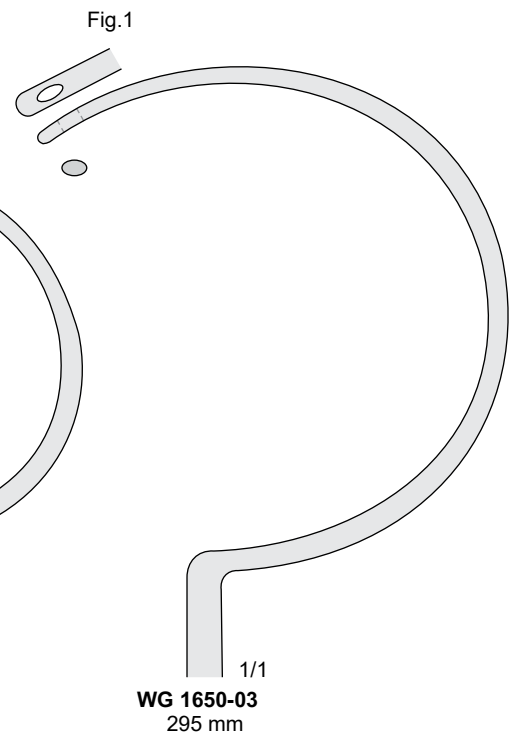
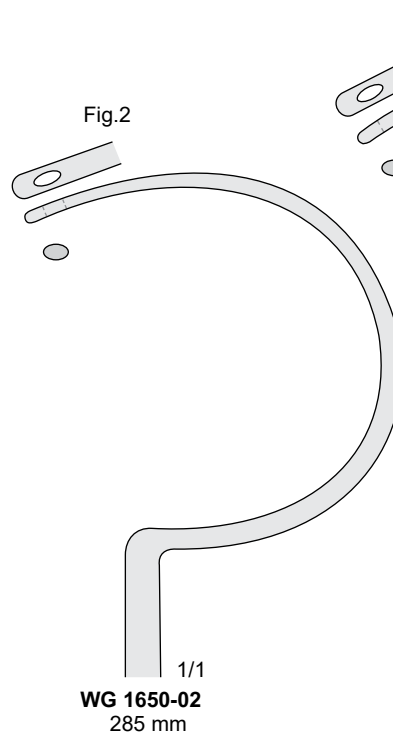
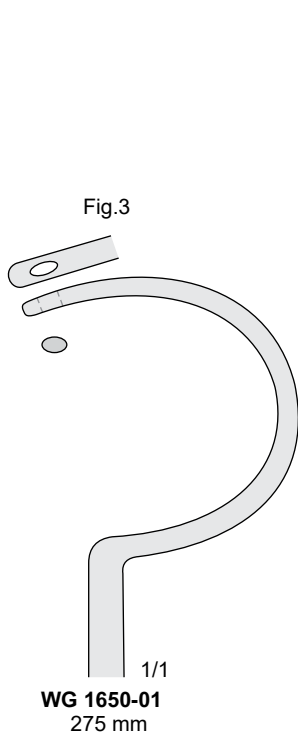
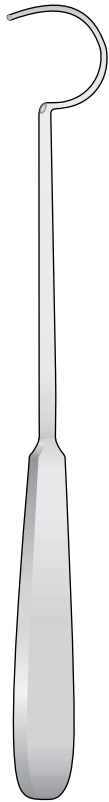

DEMEL
WG 1650-01 / WG 1650-03

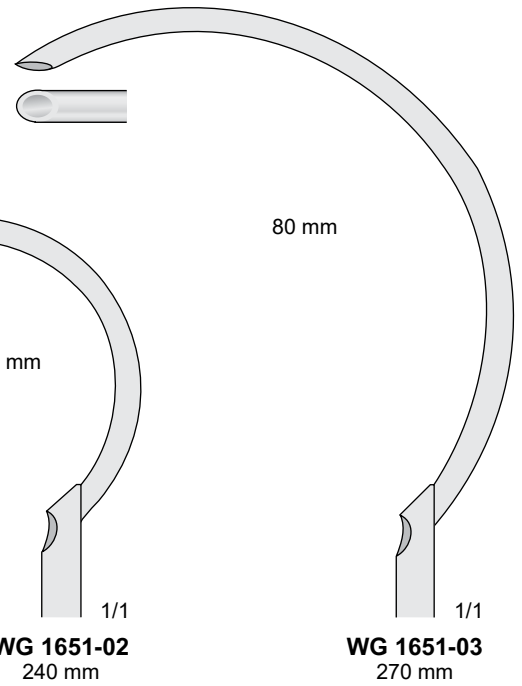
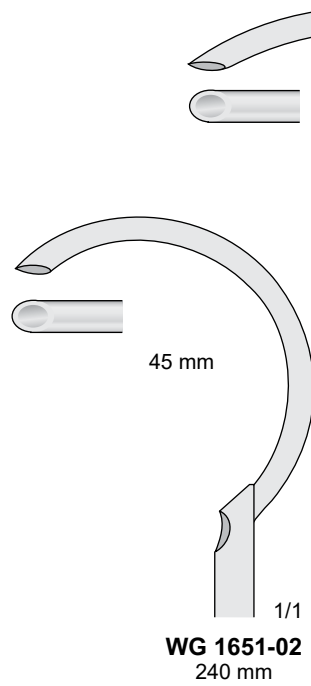
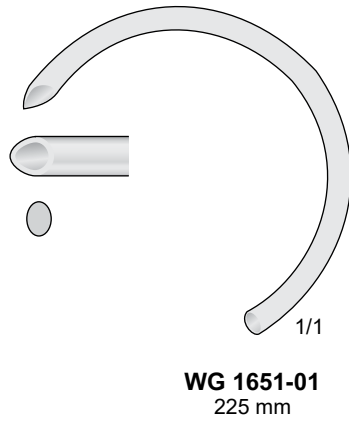
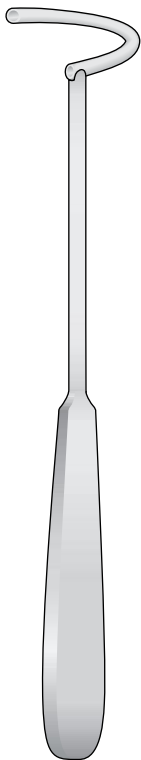

WG 1651-01 / WG 1651-03
22.5 cm

Passafili
 Wire guides
 Drahtumföhrungsnadel
 Aiguilles passe-fils
 Agujas pasa hilos

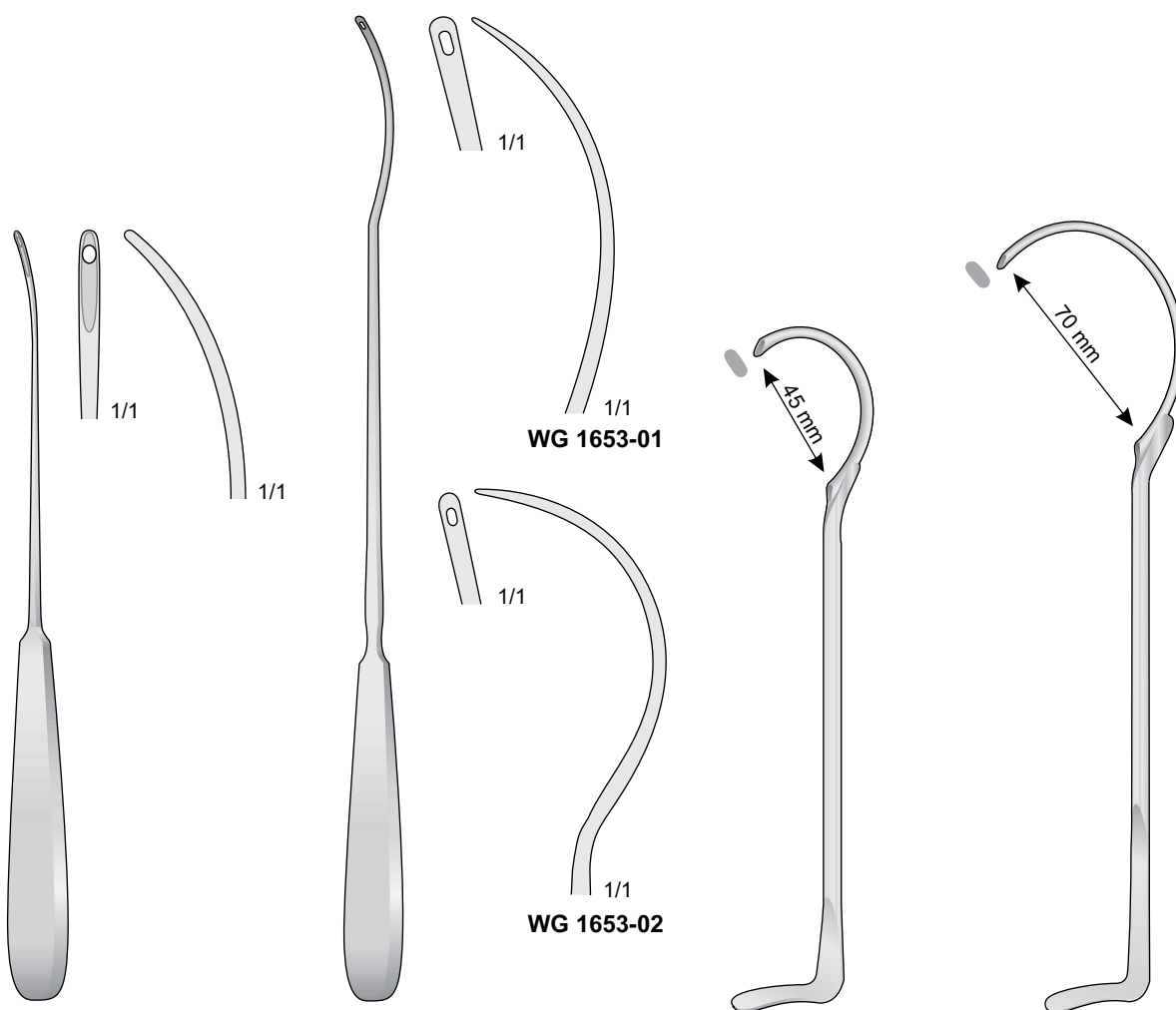

WG 1652-23 23 cm

WG 1653-01 / WG 1653-02

30 cm

WG 1654-18 18.5 cm

WG 1655-23 23.5 cm



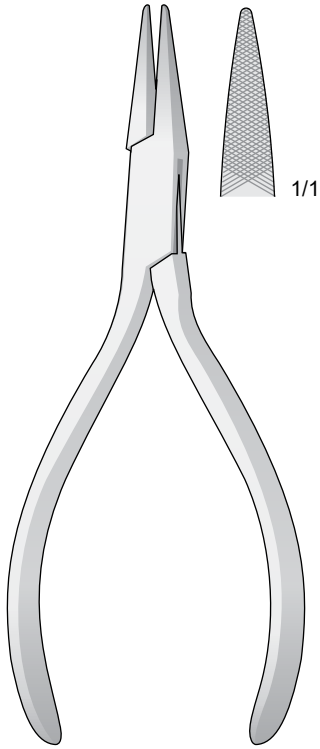

PBW 1656-14 14 cm

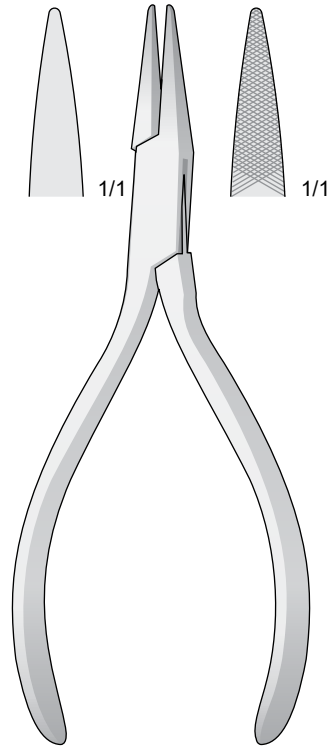

PBW 1657-14 14 cm

Per filo duro ø 1 mm
For hard wire ø 1 mm
Für harten draht ø 1 mm
Pour fil dur ø 1 mm
Para alambres duro ø 1 mm

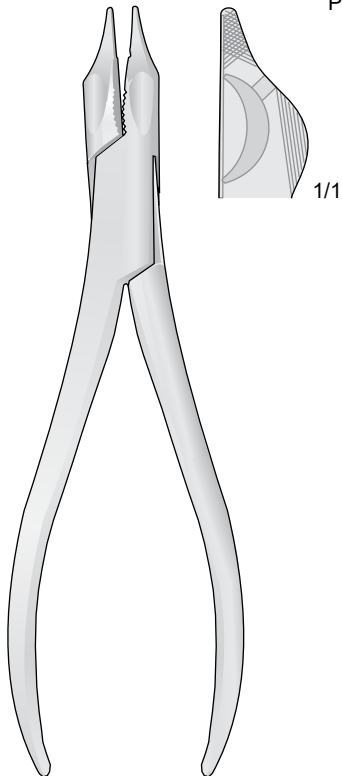

PBW 1658-15 15 cm

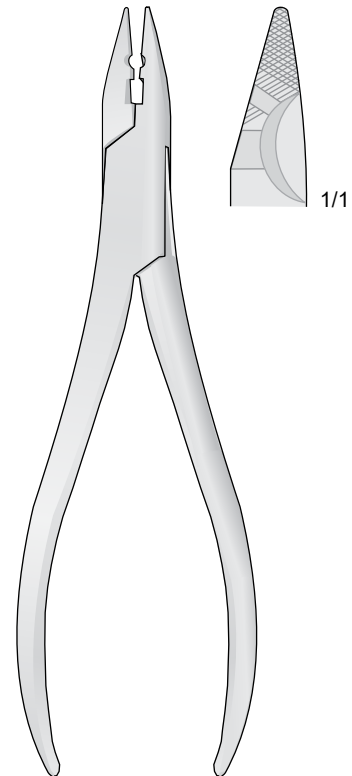

PBW 1659-16 16 cm

Pinze per estrazione fili metallici
 Extraction pliers for boring wires
 Extraktionszangen für bohrdrähte
 Pinces pour l'extraction des broches
 Pinzas para extracción de hilo metálico

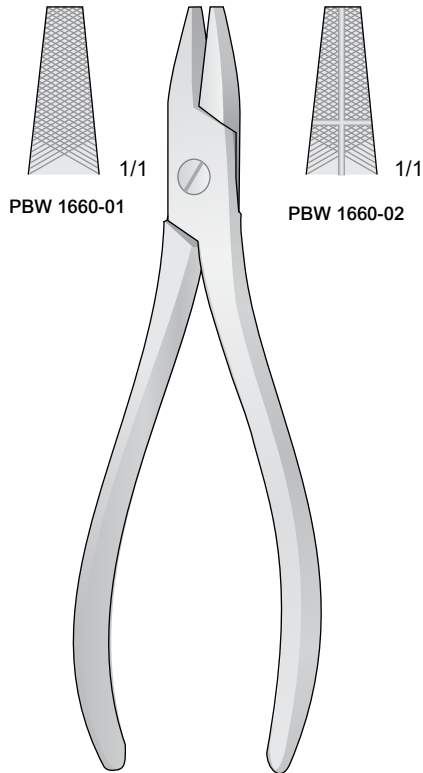

PBW 1660-01

PBW 1660-02

PBW 1660-01 / PBW 1660-02

17.5 cm

Pinza per estrazione
 fili metallici
 Flachzangen für draht

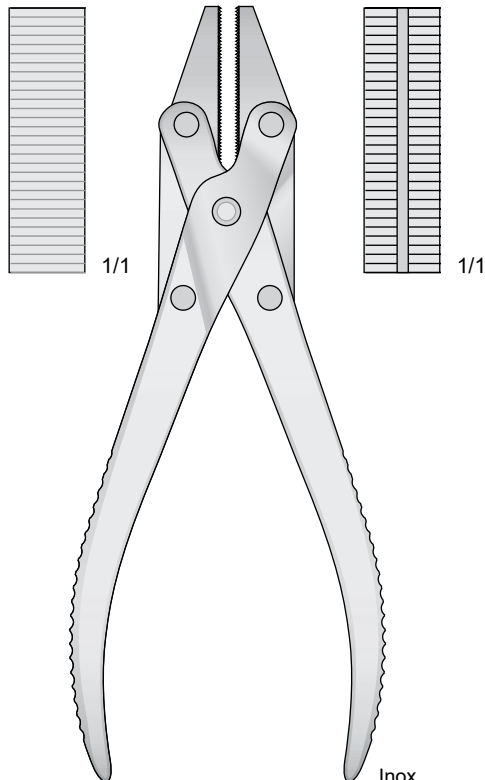

PBW 1662-18 18.5 cm

Inox

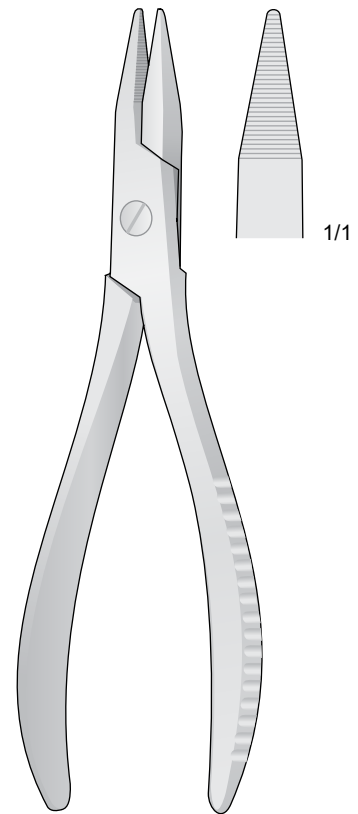

PBW 1661-19 19 cm

Pinza a branche parallele
 con tronchese

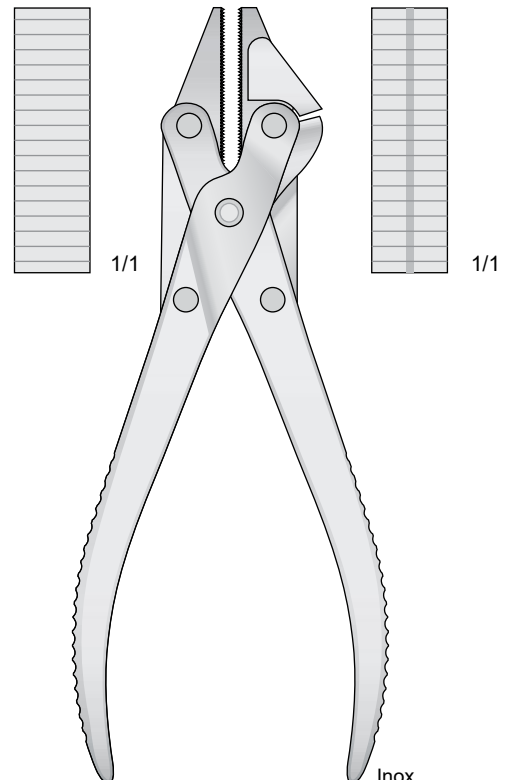

PBW 1663-18 18.5 cm

Inox

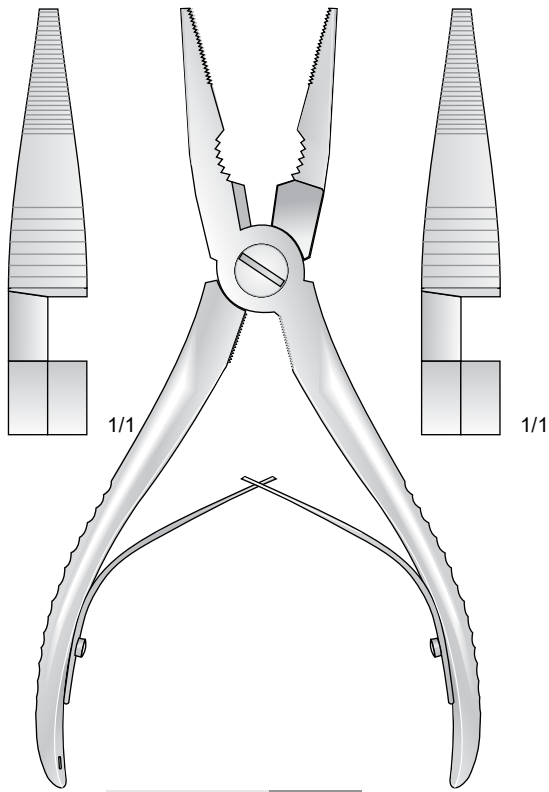

PBW 1664-17 17.5 cm

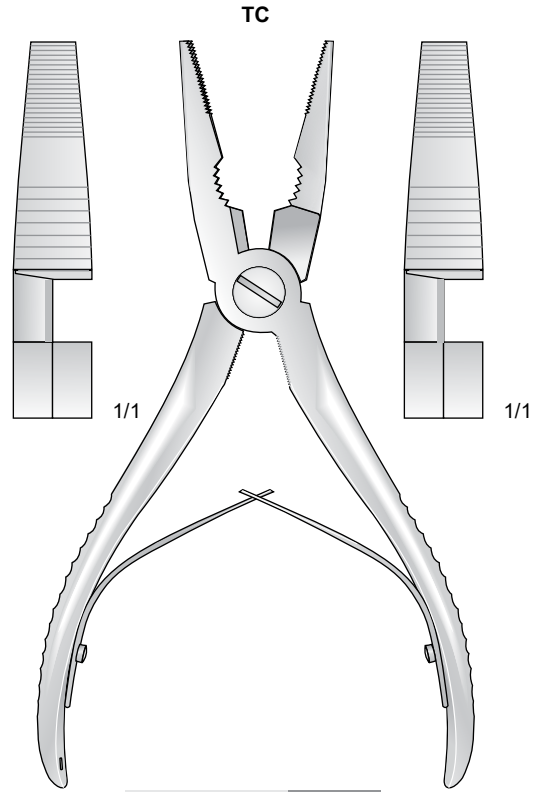

PBW 1665-16 16.5 cm

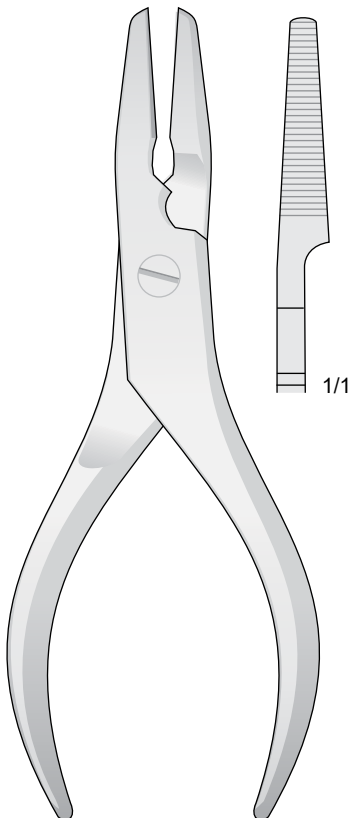

PBW 1666-16 16 cm

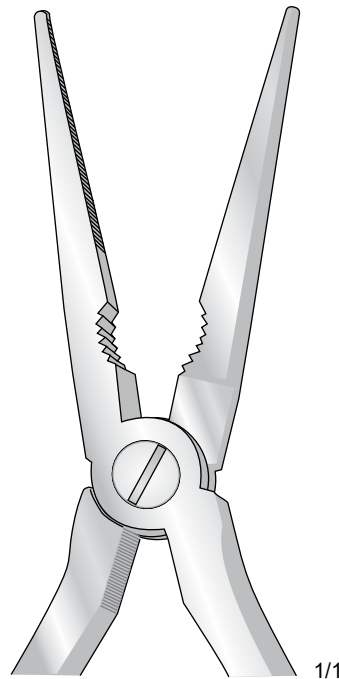

PBW 1666-20 20 cm

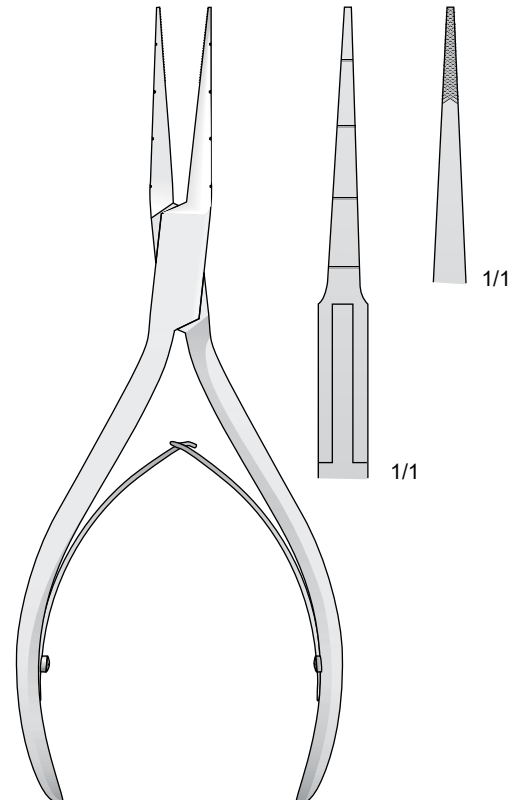

PBW 1667-15 15 cm

Pinze per estrazione fili metallici
 Extraction pliers for boring wires
 Extraktionszangen für bohrdrähte
 Pinces pour l'extraction des broches
 Pinzas para extracción de hilo metálico

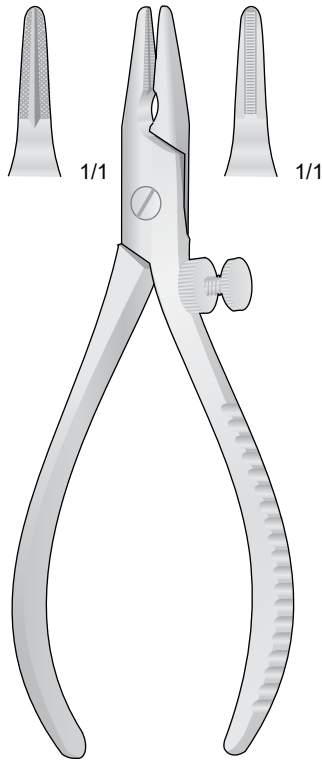

PBW 1668-14 14 cm

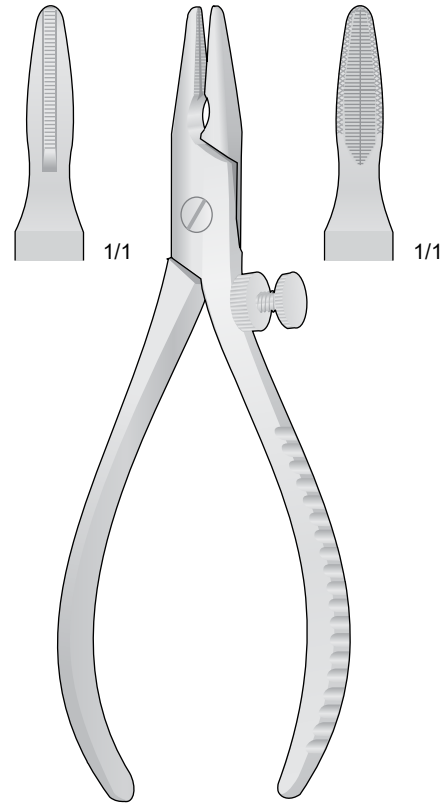

PBW 1669-18 18 cm

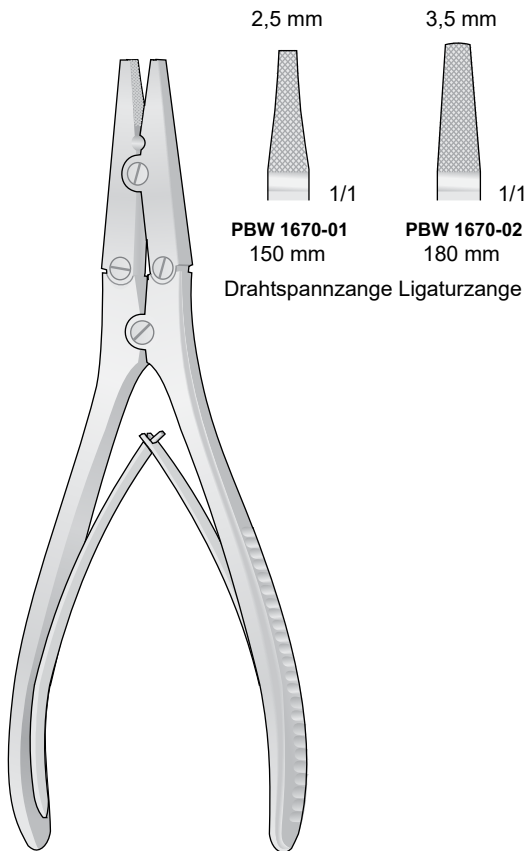

PBW 1670-01 / PBW 1670-02

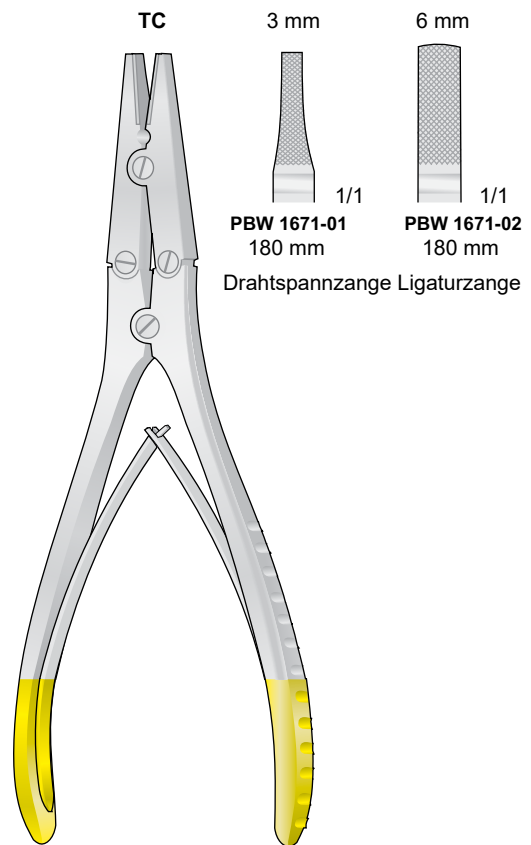

PBW 1671-01 / PBW 1671-02

Per fili duri di $\varnothing 0,4$ mm - For hard wire with $\varnothing 0,4$ mm
Für harten Draht bis $\varnothing 0,4$ mm - Pour fils durs avec $\varnothing 0,4$ mm
Para hilos duros de $\varnothing 0,4$ mm

Per filo duro $\varnothing 1$ mm - Für harten draht $\varnothing 1$ mm
For hard wire $\varnothing 1$ mm - Pour fil dur avec $\varnothing 1$ mm
Para alambres duro $\varnothing 1$ mm

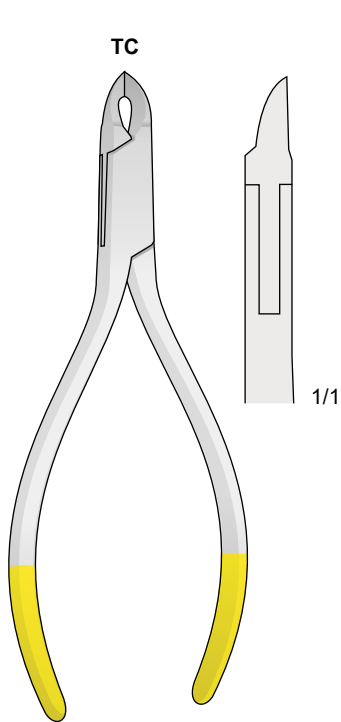

ANGLE
WCP 1672-13 13 cm

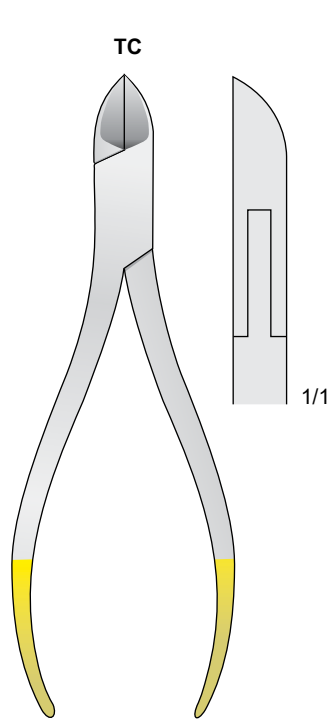

WCP 1673-13 13 cm

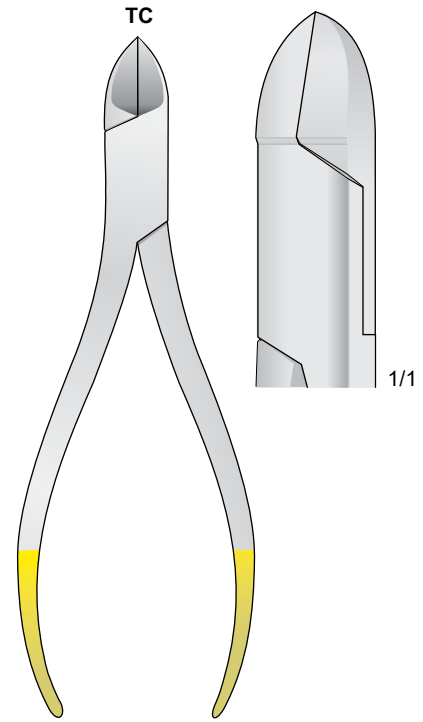

WCP 1674-15 15 cm

Per filo duro $\varnothing 1$ mm - Für harten draht $\varnothing 1$ mm
For hard wire $\varnothing 1$ mm - Pour fil dur avec $\varnothing 1$ mm
Para alambres duro $\varnothing 1$ mm

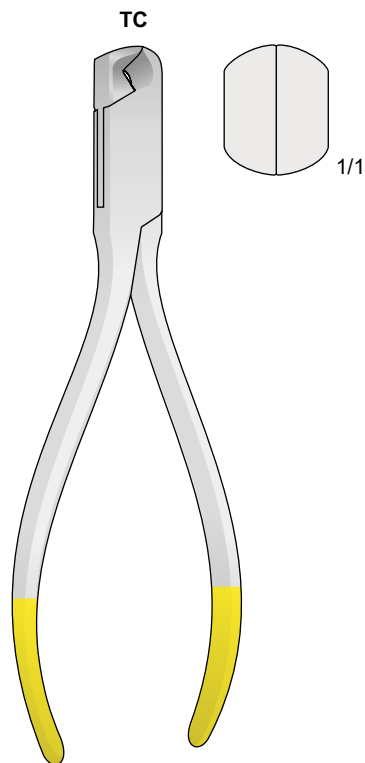

WCP 1675-14 14.5 cm

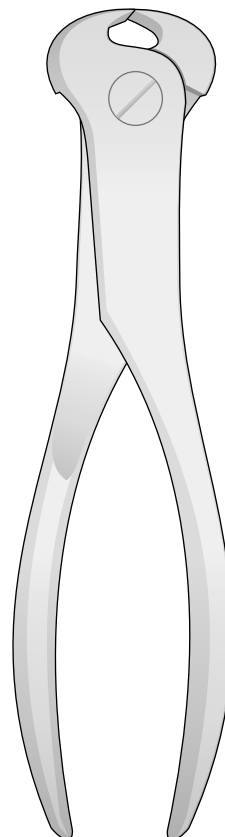

WCP 1676-18 18.5 cm

Port'aghi per fili metallic
Needle holder
Nadelhalte
Porte aiguilles pour fil métalliqu
Portaagujas para hilos

Port'aghi, pinze per fili d'acciaio
Needle holders, wire forceps
Nadelhalter, Draht-zangen
Porte aiguilles, pinces à saisir
Porta agujas, pinzas para hilos

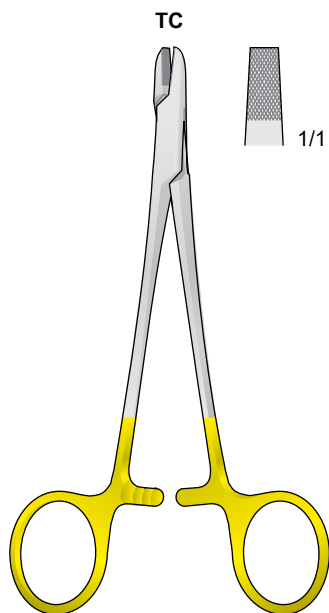

NH 1677-15 15 cm

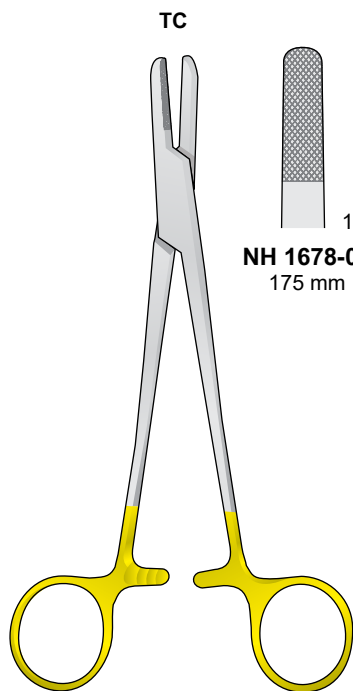

NH 1678-01
175 mm

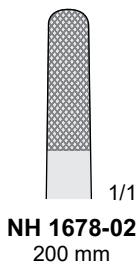

NH 1678-02
200 mm

NH 1678-01 / NH 1674-02

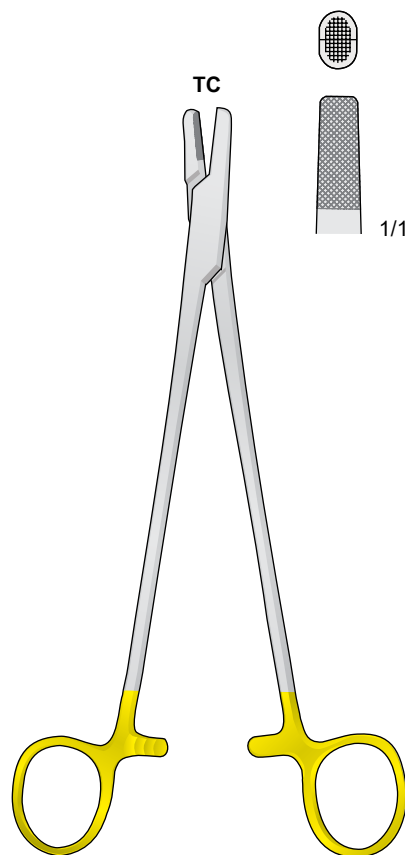

BAUMGARTNER

NH 1679-20 20 cm

Forbice universale dentellata - Draht-und Blechschere gezahnt
Wire cutting scissor serrated - Ciseaux à couper les fils métalliques
Tijeras para cortar hilo de acero dentadas

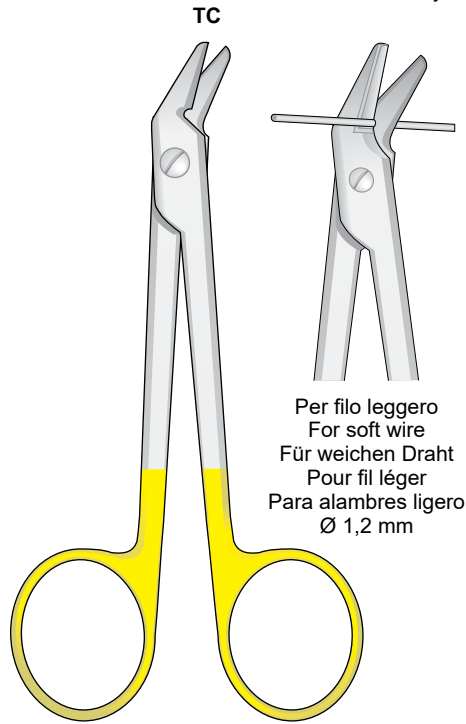

PBW 1680-12 12 cm

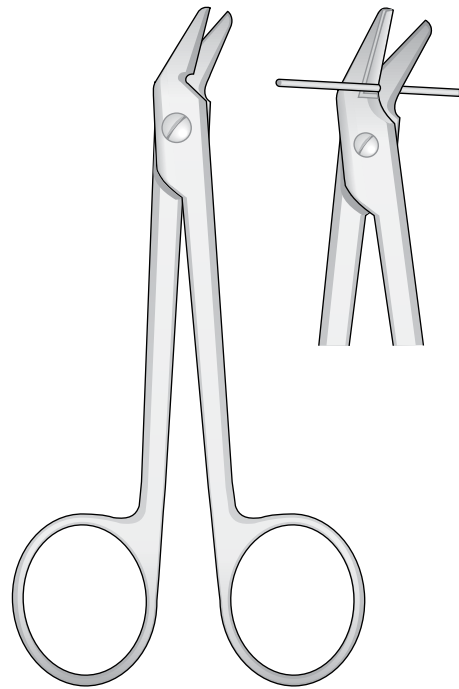

PBW 1681-12 12 cm

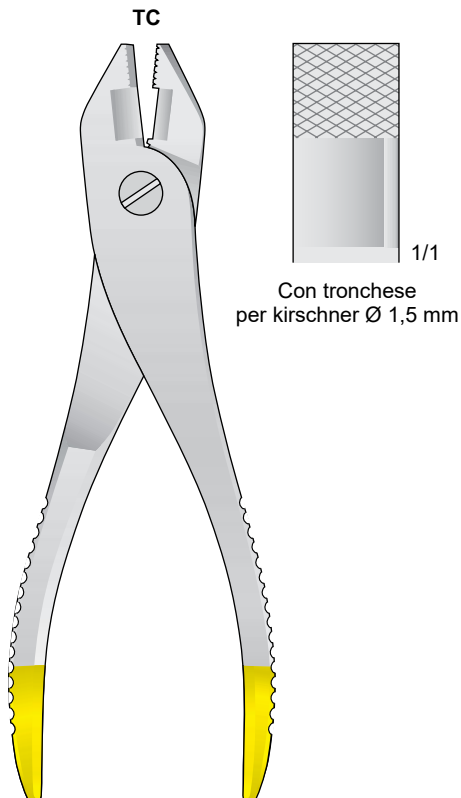

PBW 1682-22 22 cm

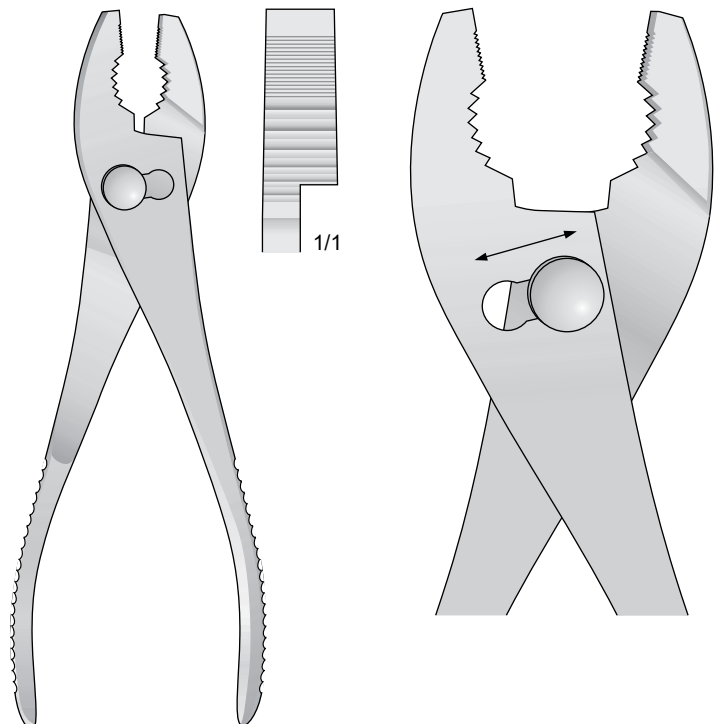

PBW 1683-20 20 cm

Tronchesi per fili metallici
Wire cutting pliers
Drahtschneidezangen
Pinces à couper le fil
Alicates para cortar alambre

Per filo leggero Ø 2 mm
Per filo duro Ø 1,5 mm
For soft wire Ø 2 mm
For hard wire Ø 1,5 mm
Für weichen Draht Ø 2 mm
Für harten Draht Ø 1,5 mm
Pour fil léger Ø 2 mm
Pour fil dur Ø 1,5 mm
Para alambres ligero Ø 2 mm
Para alambres duro Ø 1,5 mm

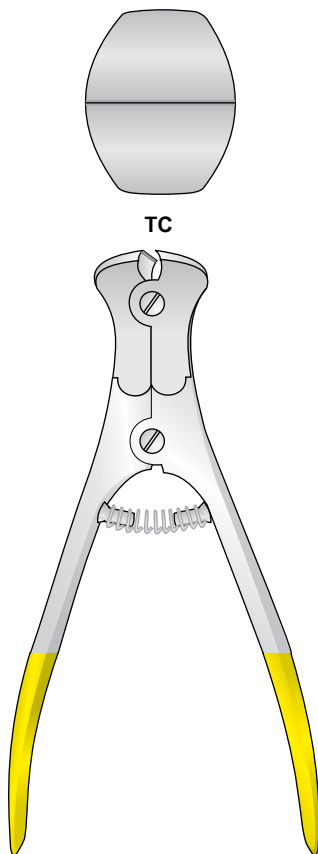

WCP 1684-14 14.5 cm

Per filo leggero Ø 2 mm
Per filo duro Ø 1,6 mm
For soft wire Ø 2 mm
For hard wire Ø 1,6 mm
Für weichen Draht Ø 2 mm
Für harten Draht Ø 1,6 mm
Pour fil léger Ø 2 mm
Pour fil dur Ø 1,6 mm
Para alambres ligero Ø 2 mm
Para alambres duro Ø 1,6 mm

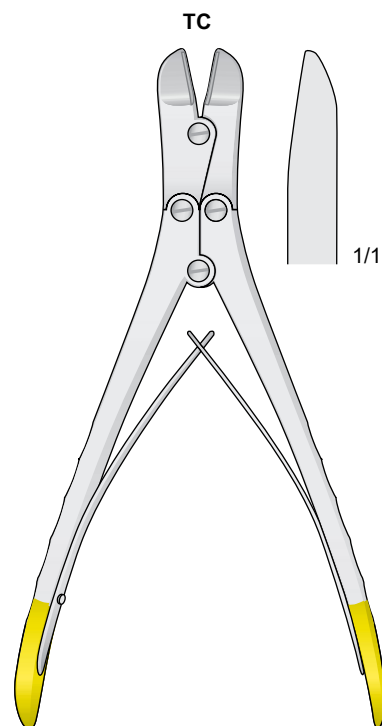

WCP 1685-17 17 cm

Per filo leggero Ø 3,5 mm
Per filo duro Ø 2,5 mm
For soft wire Ø 3,5 mm
For hard wire Ø 2,5 mm
Für weichen Draht Ø 3,5 mm
Für harten Draht Ø 2,5 mm
Pour fil léger Ø 3,5 mm
Pour fil dur Ø 2,5 mm
Para alambres ligero Ø 3,5 mm
Para alambres duro Ø 2,5 mm

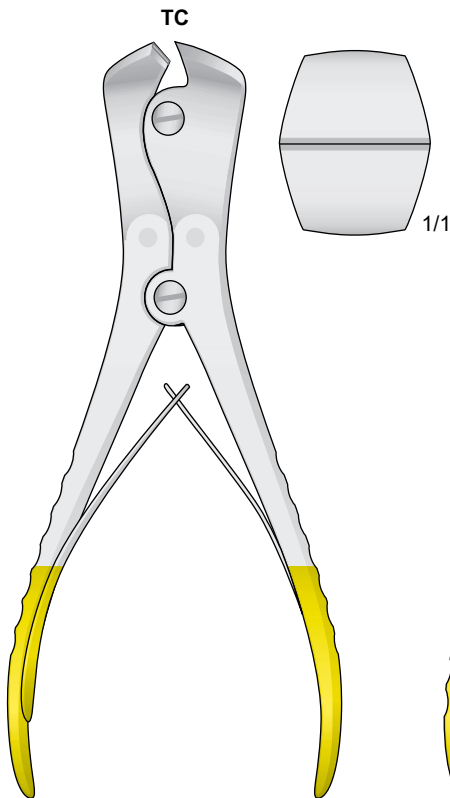

WCP 1686-21 21.5 cm

Per filo leggero Ø 3 mm
Per filo duro Ø 2,2 mm
For soft wire Ø 3 mm
For hard wire Ø 2,2 mm
Für weichen Draht Ø 3 mm
Für harten Draht Ø 2,2 mm
Pour fil léger Ø 3 mm
Pour fil dur Ø 2,2 mm
Para alambres ligero Ø 3 mm
Para alambres duro Ø 2,2 mm

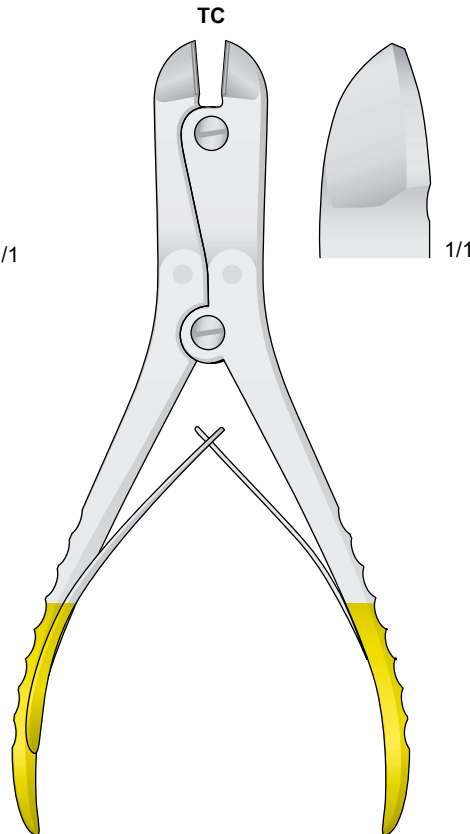

WCP 1687-23 23 cm

Per filo leggero Ø 2,5 mm
Per filo duro Ø 2 mm
For soft wire Ø 2,5 mm
For hard wire Ø 2 mm
Für weichen Draht Ø 2,5 mm
Für harten Draht Ø 2 mm
Pour fil léger Ø 2,5 mm
Pour fil dur Ø 2 mm
Para alambres ligero Ø 2,5 mm
Para alambres duro Ø 2 mm

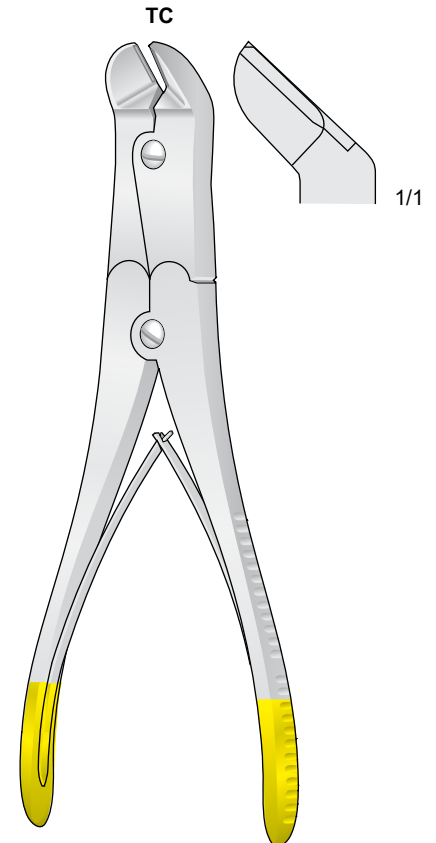

WCP 1688-23 23 cm

Tronchesi per fili metallici
 Wire cutting pliers
 Drahtschneidezangen
 Pincès à couper le fil
 Alicates para cortar alambre

Per filo leggero Ø 7 mm
 Per filo duro Ø 6 mm
 For soft wire Ø 7 mm
 For hard wire Ø 6 mm
 Für weichen Draht Ø 7 mm
 Für harten Draht Ø 6 mm
 Pour fil léger Ø 7 mm
 Pour fil dur Ø 6 mm
 Para alambres ligero Ø 7 mm
 Para alambres duro Ø 6 mm

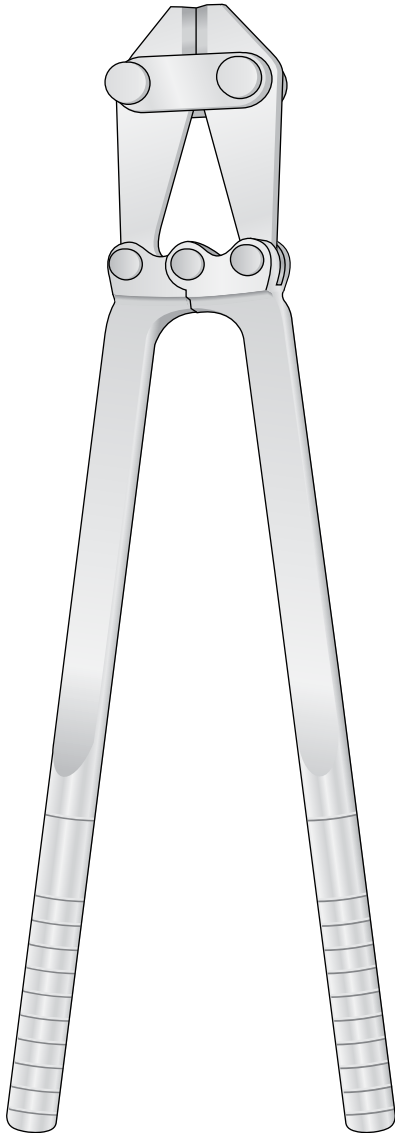

WCP 1689-48 48 cm

Per filo leggero Ø 7 mm
 Per filo duro Ø 6 mm
 For soft wire Ø 7 mm
 For hard wire Ø 6 mm
 Für weichen Draht Ø 7 mm
 Für harten Draht Ø 6 mm
 Pour fil léger Ø 7 mm
 Pour fil dur Ø 6 mm
 Para alambres ligero Ø 7 mm
 Para alambres duro Ø 6 mm

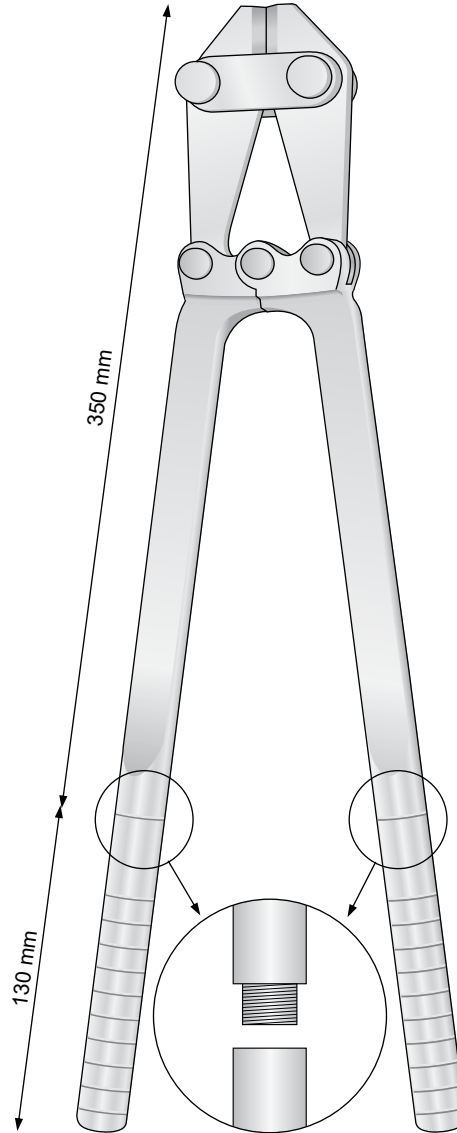

WCP 1690-48 48 cm

Per filo leggero Ø 5 mm
 Per filo duro Ø 4,5 mm
 For soft wire Ø 5 mm
 For hard wire Ø 4,5 mm
 Für weichen Draht Ø 5 mm
 Für harten Draht Ø 4,5 mm
 Pour fil léger Ø 5 mm
 Pour fil dur Ø 4,5 mm
 Para alambres ligero Ø 5 mm
 Para alambres duro Ø 4,5 mm

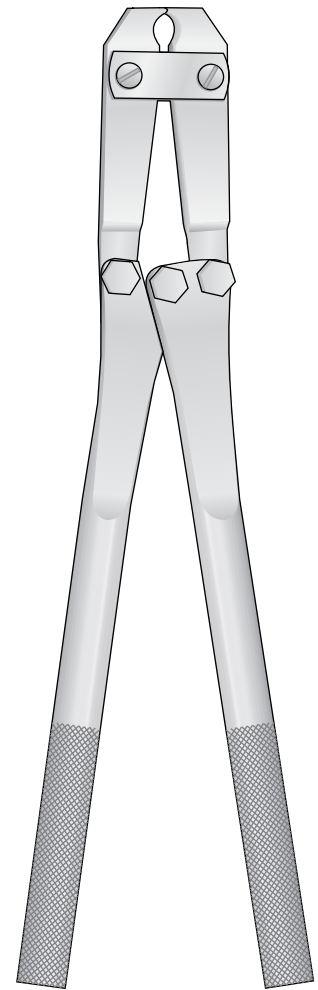

WCP 1691-37 37.5 cm

Misuratore per chiodi Kirschner
Meßlehre für Kirschnerdrähte

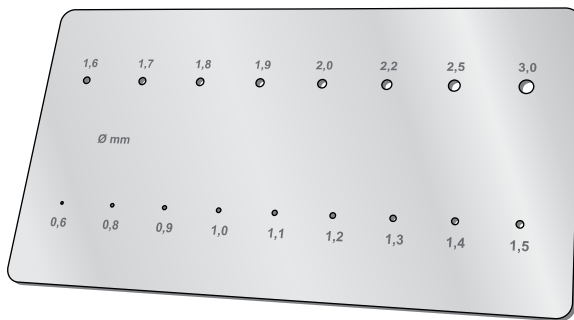

MI 1692

0,5 mm



MI 1692-05 50 mm

0,5 mm



MI 1692-12 120 mm

0,5 mm



MI 1692-15 150 mm

0,5 mm



MI 1692-30 300 mm

Misuratore di lunghezza per viti
Screw depth gauges, to select proper length of screw
Instruments de mesure de profondeur pour déterminer la longueur de vis requise

Per viti Ø
For screw Ø
Für Schrauben Ø
Pour vis de Ø



MI 1693-16 16.5 cm

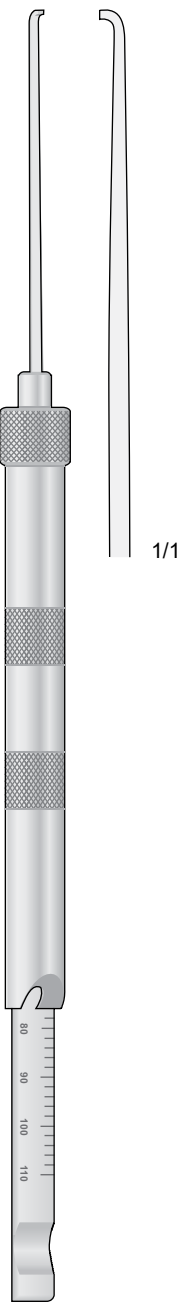

MI 1694-26 26.5 cm

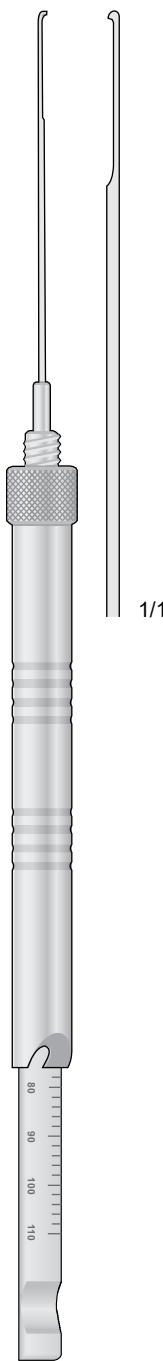

MI 1695-28 28 cm

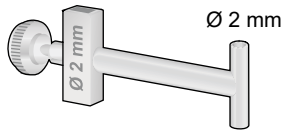

BS 1696-02 Ø 2 mm

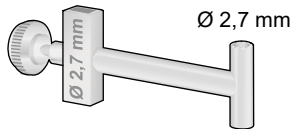

BS 1696-03 Ø 2,7 mm

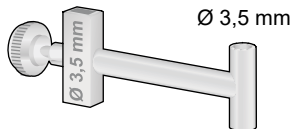

BS 1696-04 Ø 3,5 mm

Centrapunte
Manicotto dentato
Steckbohrbüchsen
Insert-drill

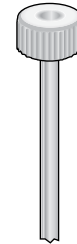

Ø Esterno	Ø Per punte
Ø Outside	Ø For drills
Ø Außen	Ø Für Bohrer
Ø Extérieur	Ø Pour Mèches
Ø Exterior	Ø Para agujas

Cod. Art.	Ø Esterno	Ø Per punte
BS 1697-01	4,5 mm	3,2 mm
BS 1697-02	3,5 mm	2 mm
BS 1697-03	3,5 mm	2,7 mm

Guida per punte elicoidali
Gewebeschützülzen

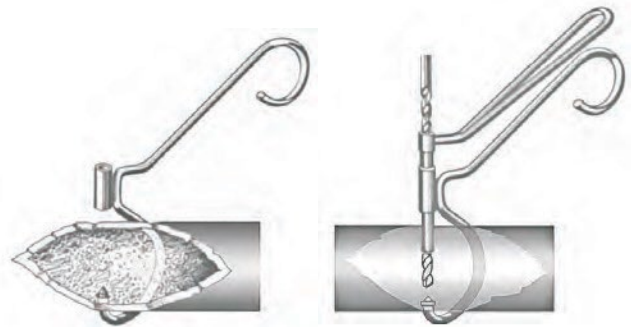

BS 1696-05
Completo di 3 guide

BS 1696-01
Centratore solo

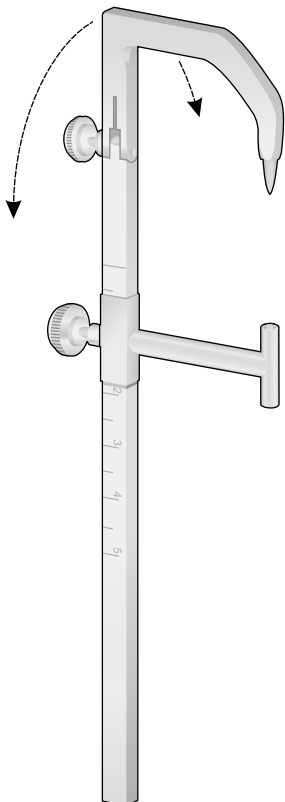

BS 1696
14.5 cm

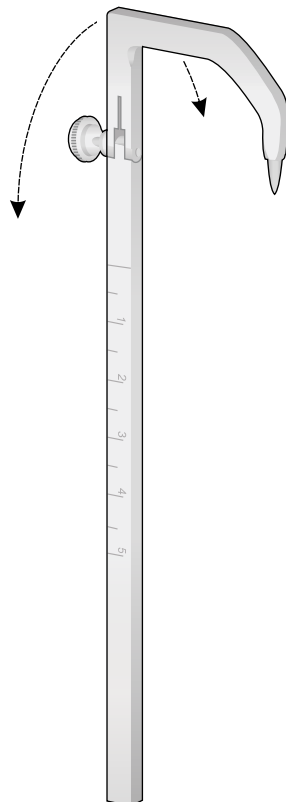

BS 1696-01
14.5 cm

Interno Ø 6,5 mm
Inside Ø 6,5 mm
Innen Ø 6,5 mm
Intérieur Ø 6,5 mm
Interior Ø 6,5 mm

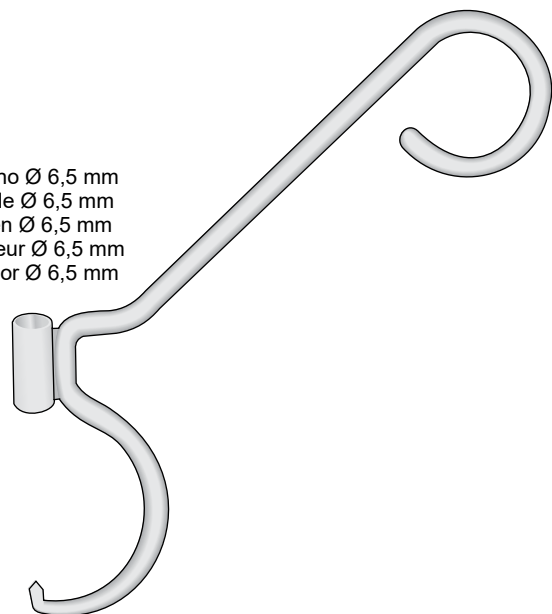

BS 1697

Attacco Dentale
 Dental schaft

Ø 1,5 mm



TD 1698-01
 50 mm

Ø 2,0 mm



TD 1698-02
 55 mm

Attacco AO
 Mit AO schaft

Ø 1,5 mm



TD 1699-01
 65 mm

Ø 2 mm



TD 1699-02
 70 mm

Ø 2,7 mm



TD 1699-03
 100 mm

Passo della vite
 a 1,25 mm

Ø 3,5 mm



TD 1699-04
 110 mm

Passo della vite
 a 1,75 mm

Ø 3,5 mm



TD 1699-05
 110 mm

Ø 4,5 mm



TD 1699-06
 130 mm

Ø 4,5 mm



TD 1699-07
 130 mm

Ø 6,5 mm



TD 1699-08
 170 mm

Punte elicoidali con innesto rapido

Attacco AO
Mit AO schaft
Drill bits

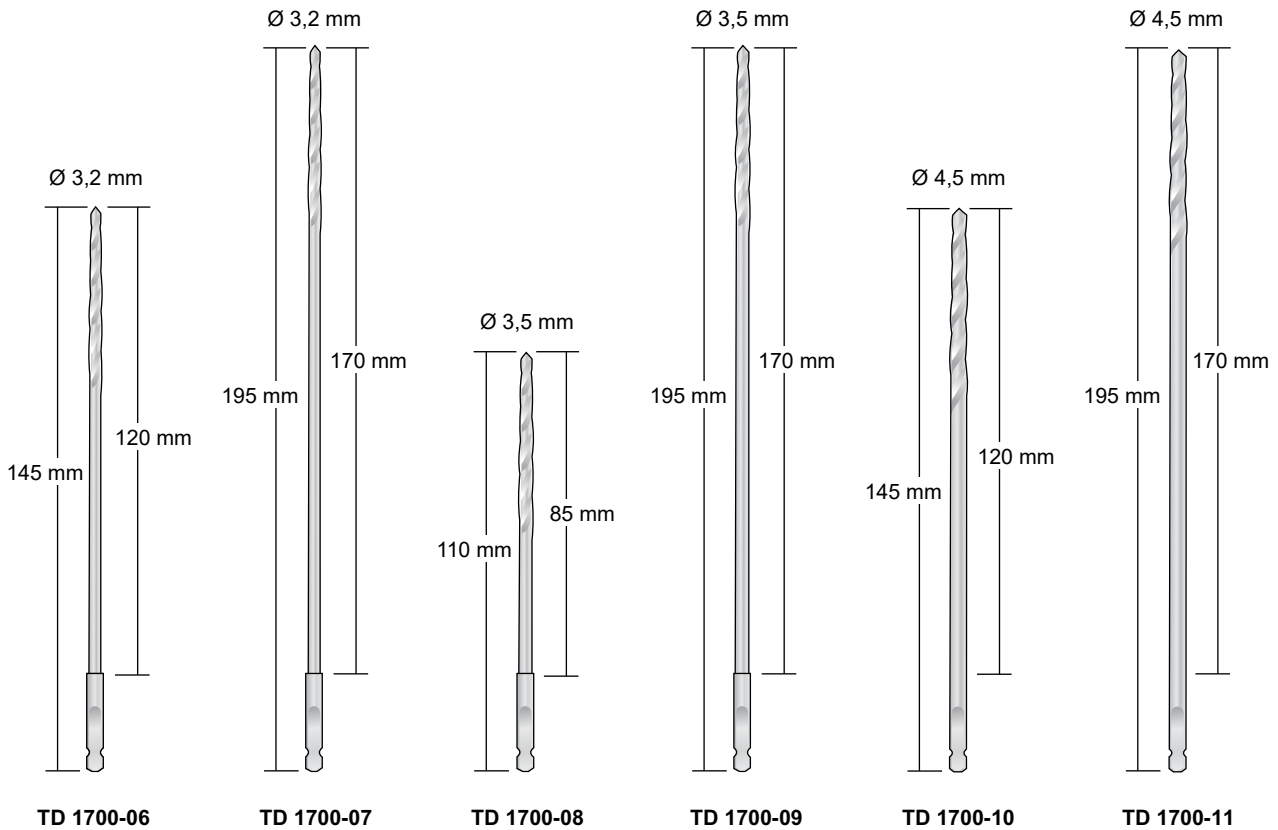
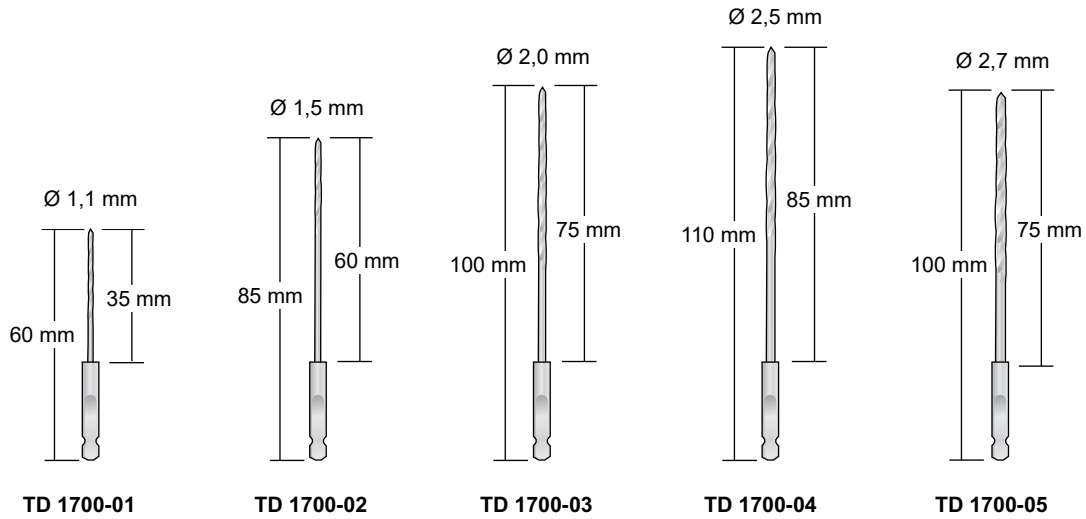

Punte elicoidali

Con attacco rotondo
 Mit rundschaft
 Drill bits

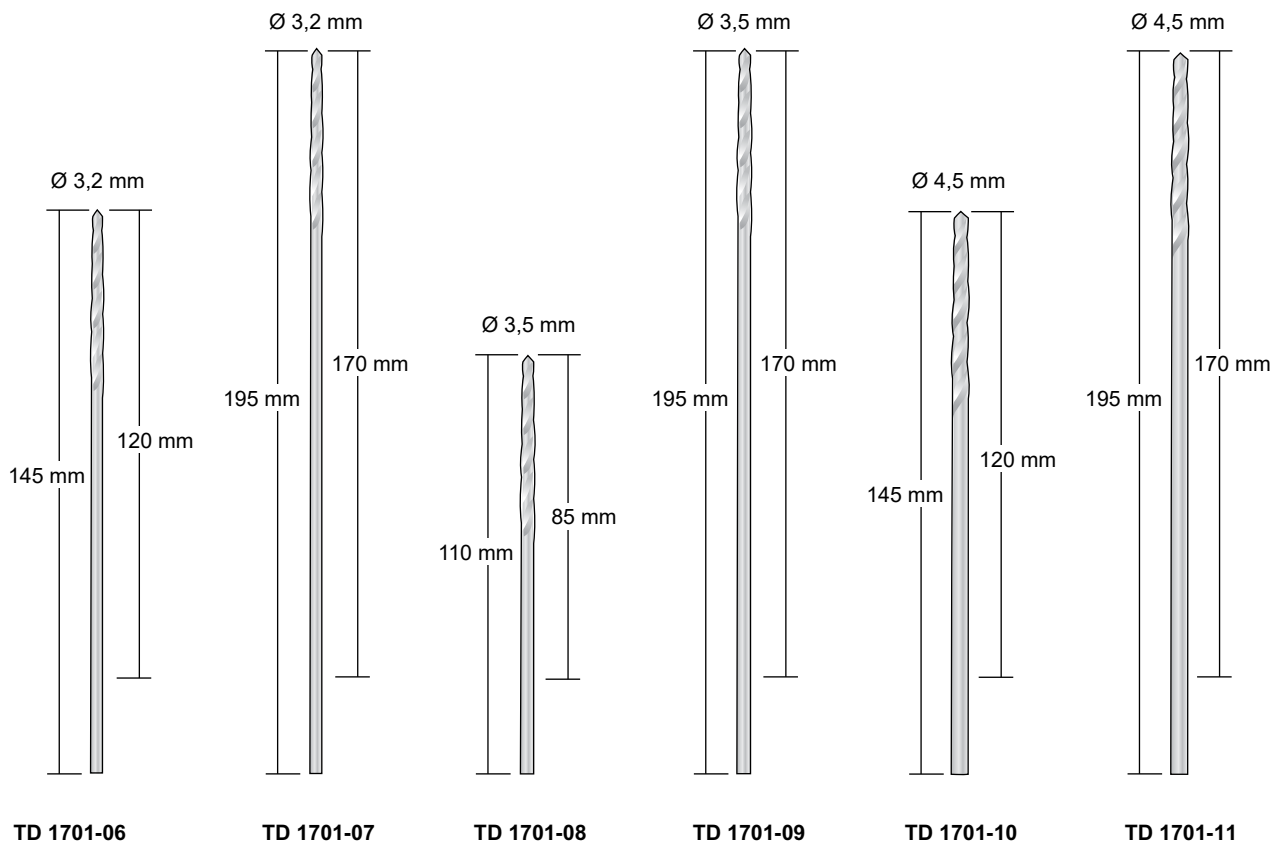
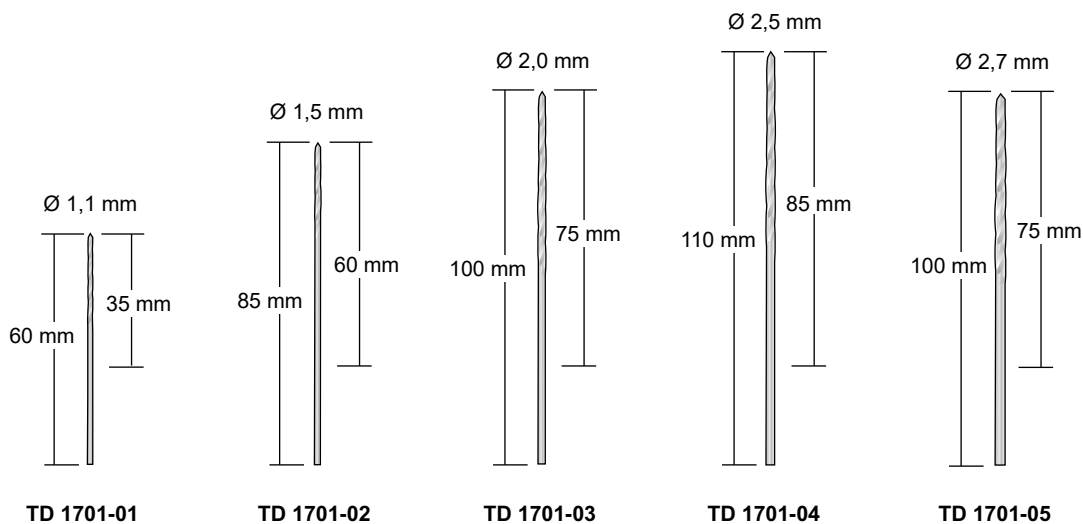

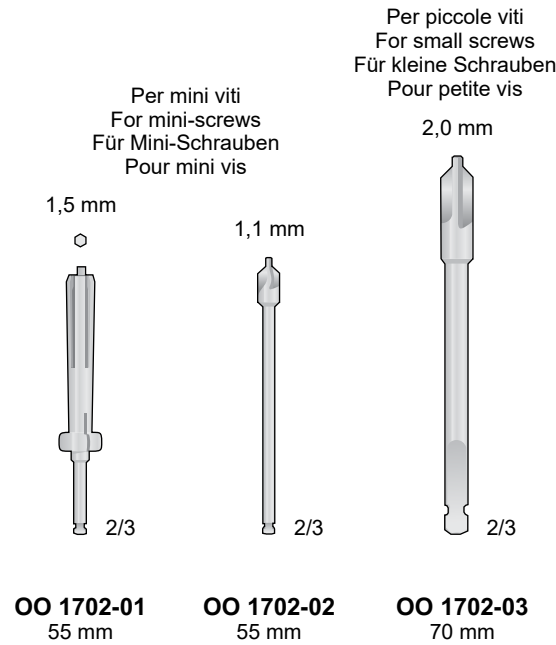

Per viti malleolari
For malleolar screws
Für Malleolarschrauben
Pour vis à malléole

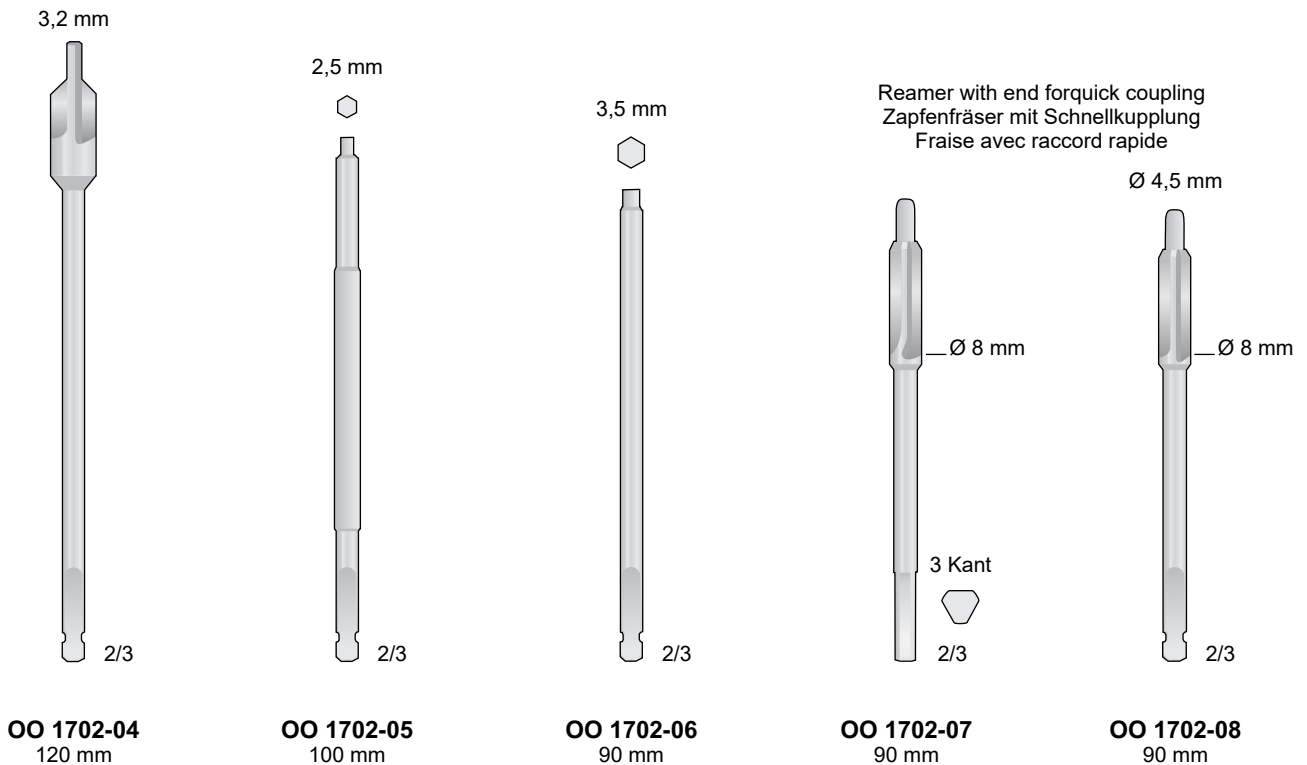

Manico con mandrino rapido
 Handles with quick-action chuck
 Handgriffe mit schnellspann futter
 Poignées avec mandrins rapides

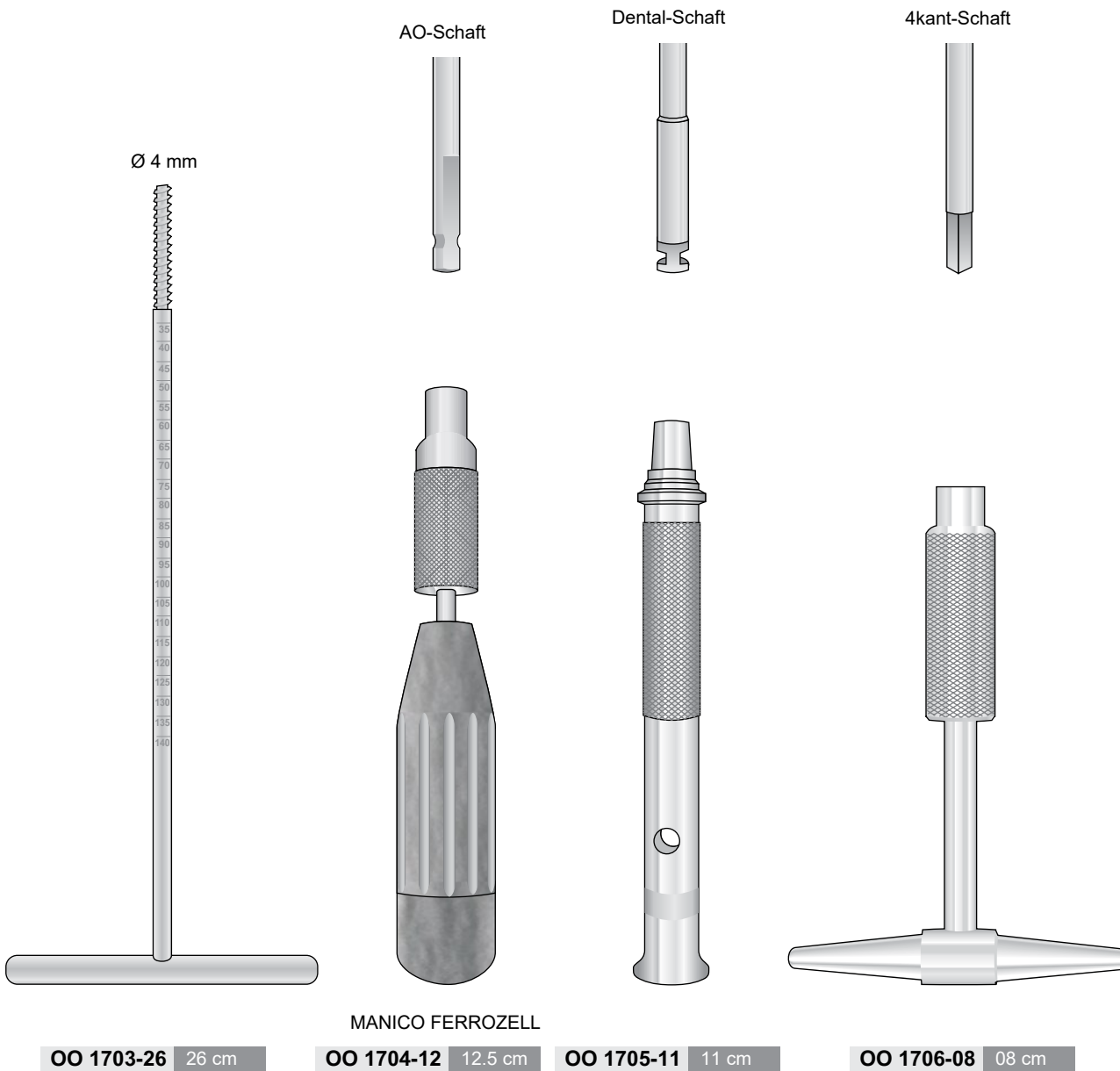

Centratori guida punte - Drill guides - Bohrbüchsen zu Knochenplatten - Guide méche

Per trapano Ø 2 mm

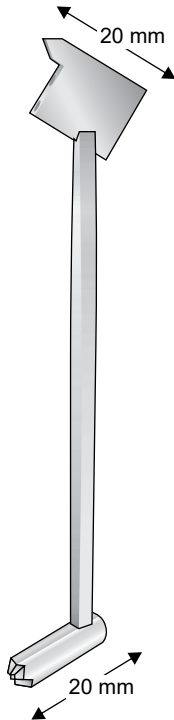

OO 1707-11 11 cm

Per viti da corticale Ø 3,5 mm
Per maschiatore Ø 2,5 mm



OO 1708

Per viti da corticale Ø 6,5 mm
Per maschiatore Ø 3,2 mm



OO 1709

Per trapano Ø 1,1/1,5 mm

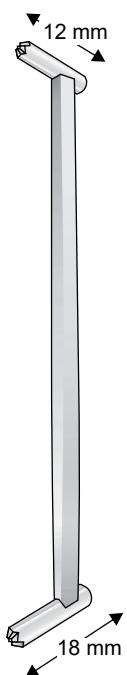

OO 1710-10 10.5 cm

Per trapano Ø 2,5 mm
Per viti da corticale Ø 3,5 mm
Per maschiatore Ø 3,5 mm

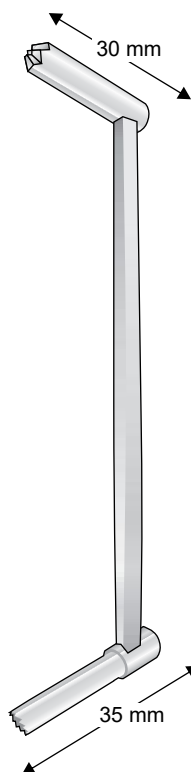

OO 1711-12 12.5 cm

Per viti da corticale Ø 4,5 mm
Per maschiatore Ø 3,2 mm

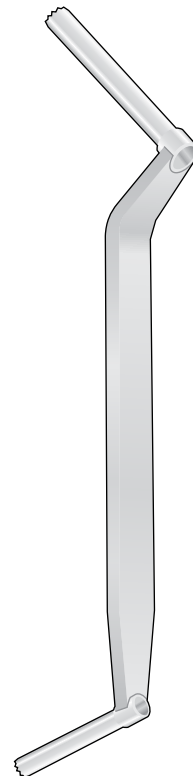

OO 1712

Centratori guida punte - Drill guides - Bohrbüchsen zu Knochenplatten - Guide méche

Codificazione del colore

verde = centrico
 oro = eccentrico

Per trapano Ø 2,0 mm
 Per viti da corticale Ø 2,7 mm

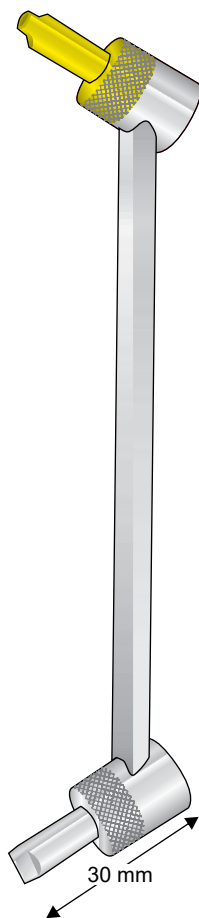

OO 1713-14 14 cm

Per trapano Ø 2,5 mm
 Per viti da corticale Ø 3,5 mm

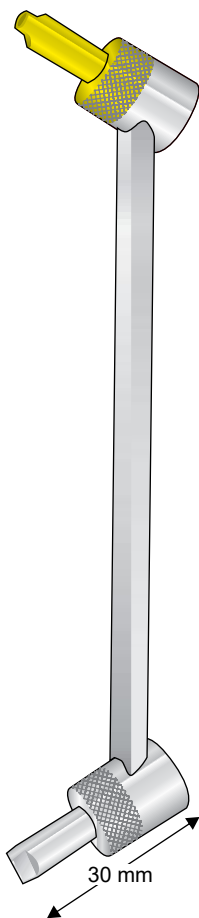

OO 1714-14 14 cm

Per trapano Ø 3,2 mm
 Per viti da corticale Ø 4,5 mm

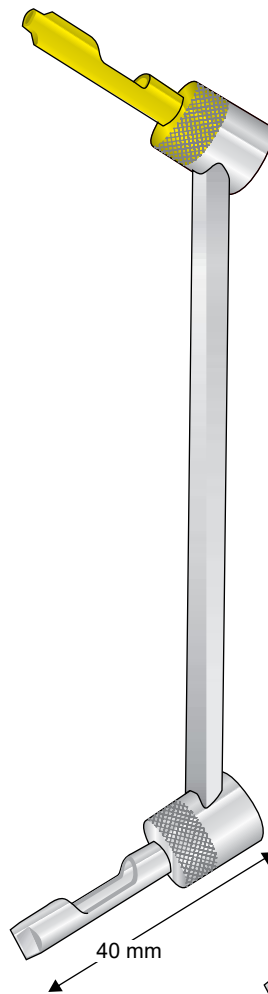

OO 1715-16 16.5 cm

Per trapano Ø 3,2 mm
 Per viti da corticale Ø 4,5 mm

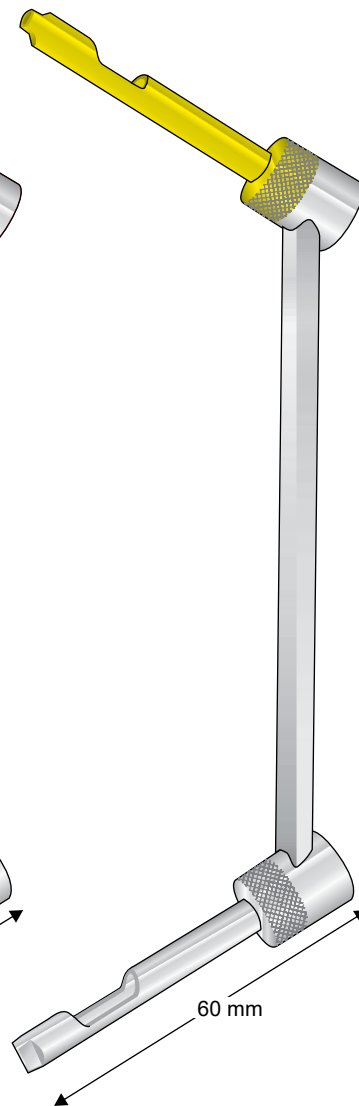

OO 1716-17 17 cm

Centratori guida punte - Drill guides - Bohrbüchsen zu Knochenplatten - Guide méche

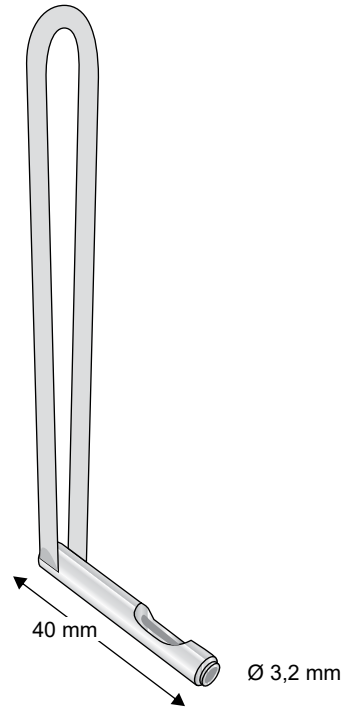

OO 1717-12 12.5 cm

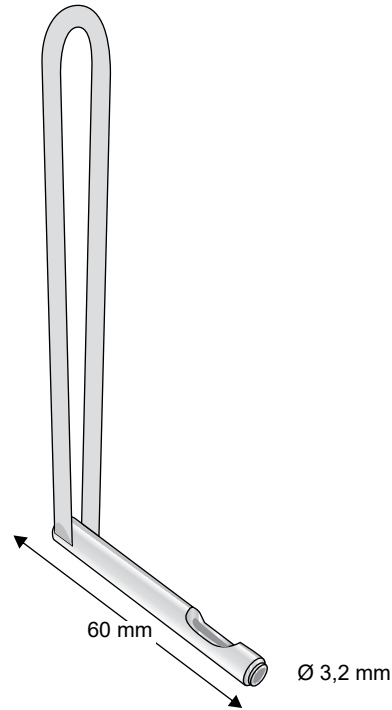

OO 1718-12 12.5 cm

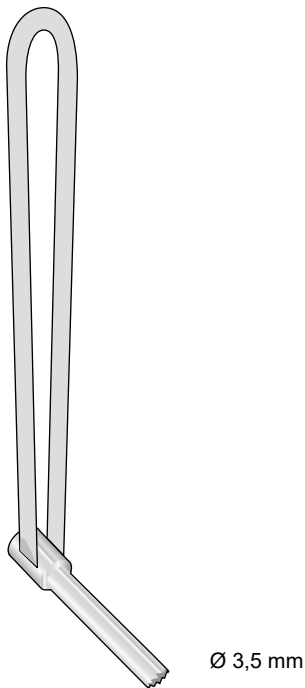

OO 1719-12 12.5 cm

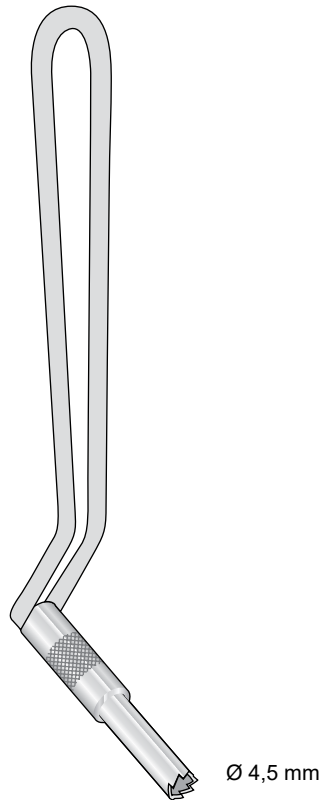

OO 1720-15 15 cm

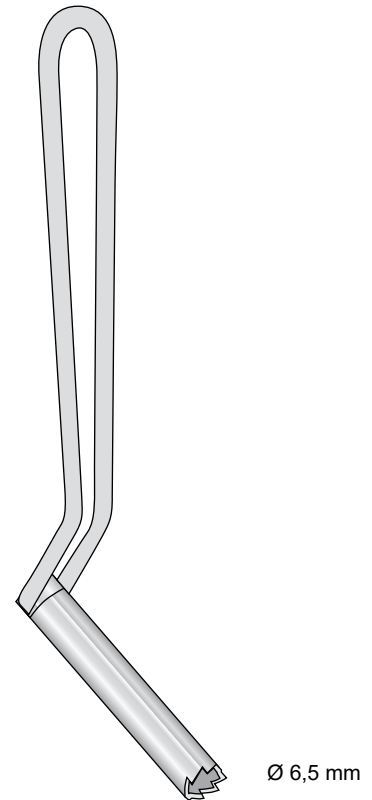

OO 1721-15 15 cm

Scatola con set giraviti - Box with screws driver - Schraubenzieher, Set mit Etui
 Jeu de tournevis, en boîte - Set destornilladores

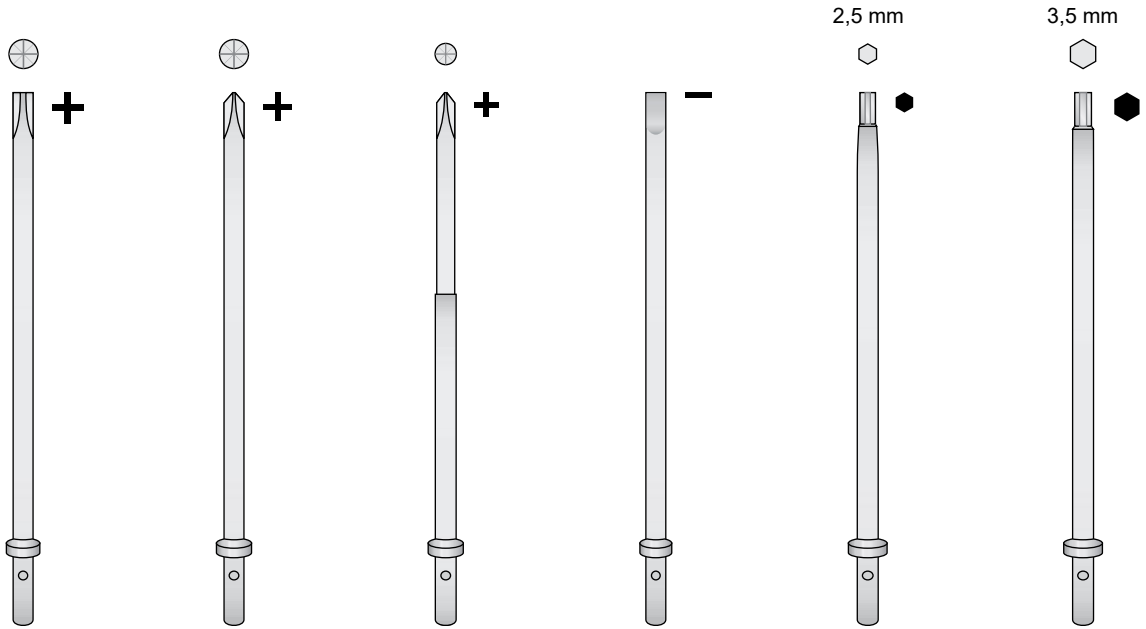

OO 1722-01
140 mm

OO 1722-02
140 mm

OO 1722-03
140 mm

OO 1722-04
140 mm

OO 1722-05
140 mm

OO 1722-06
140 mm

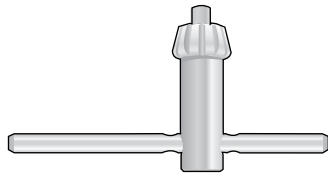

OO 1724-02 3.2 cm

OO 1726
 Scatola con set giraviti - Completo
 Box with screws driver - Complete
 Schraubenzieher, Set mit Etui - Komplett
 Jeu de tournevis, en boîte - Complete
 Set destornilladores - Completos

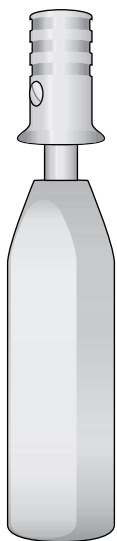

OO 1723-14 14.5 cm

Max. Ø 6,3 mm

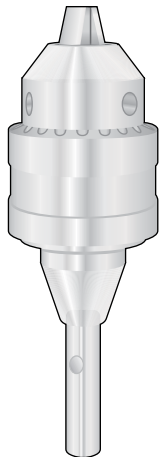

OO 1724-01 7.5 cm
 UNIVERSAL

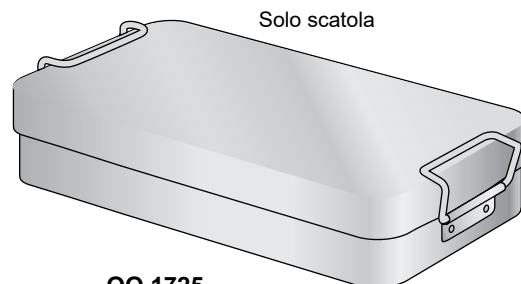

OO 1725
200x100x40 mm

Giraviti - Screws driver - Schraubenzieher - Jeu de tournevis - Destornilladores

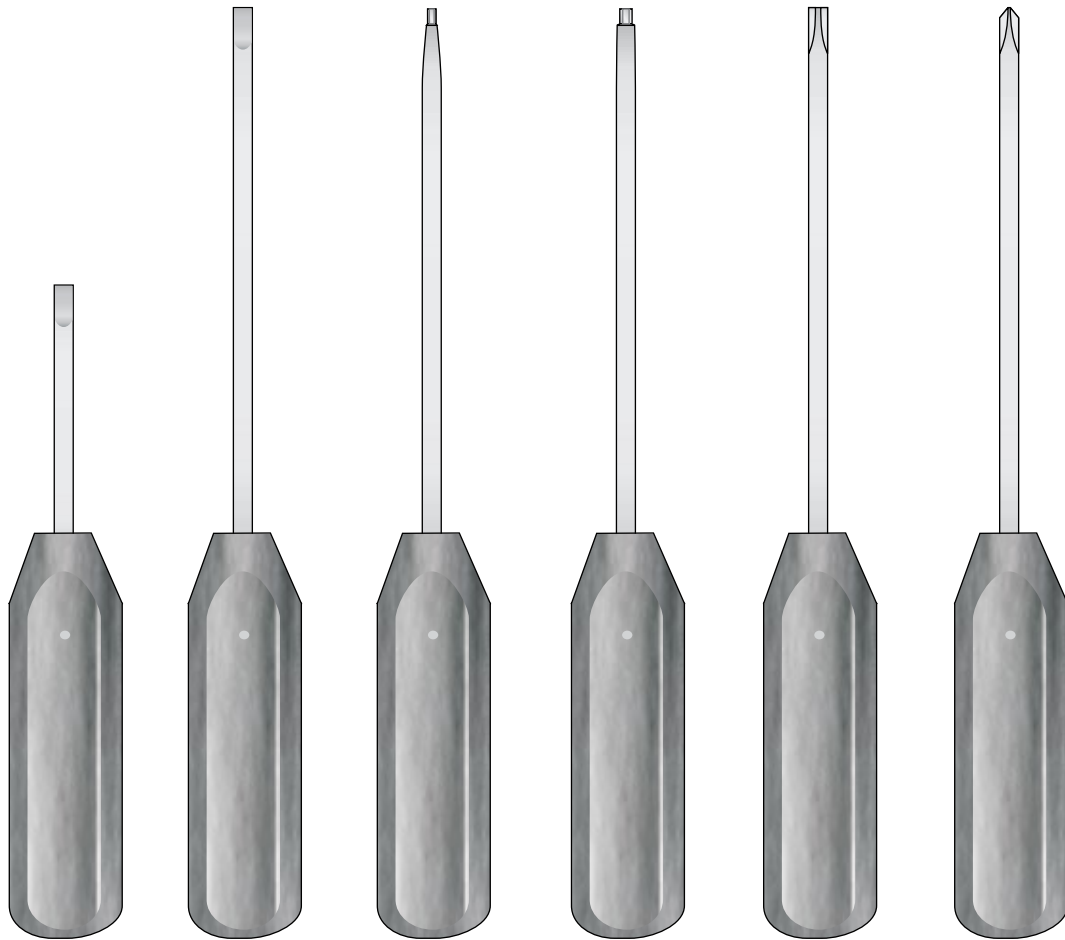
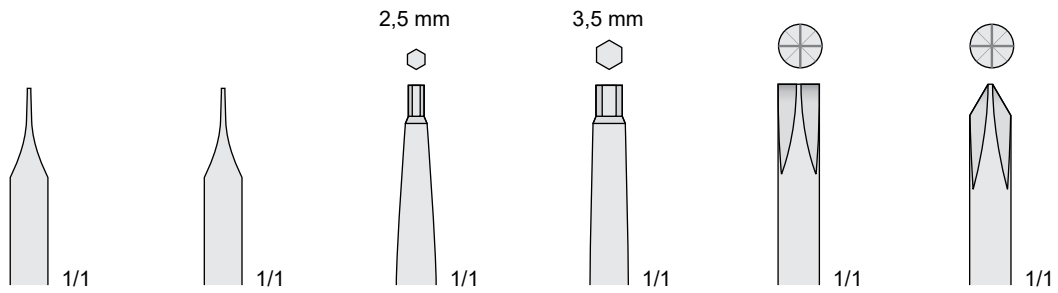

OO 1727-01
17 cm

LANE
OO 1727-02
25 cm

OO 1727-03
25 cm

OO 1727-04
25 cm

OO 1727-05
25 cm

PHILIPS
OO 1727-06
25 cm

Giraviti - Screws driver - Schraubenzieher - Jeu de tournevis - Destornilladores

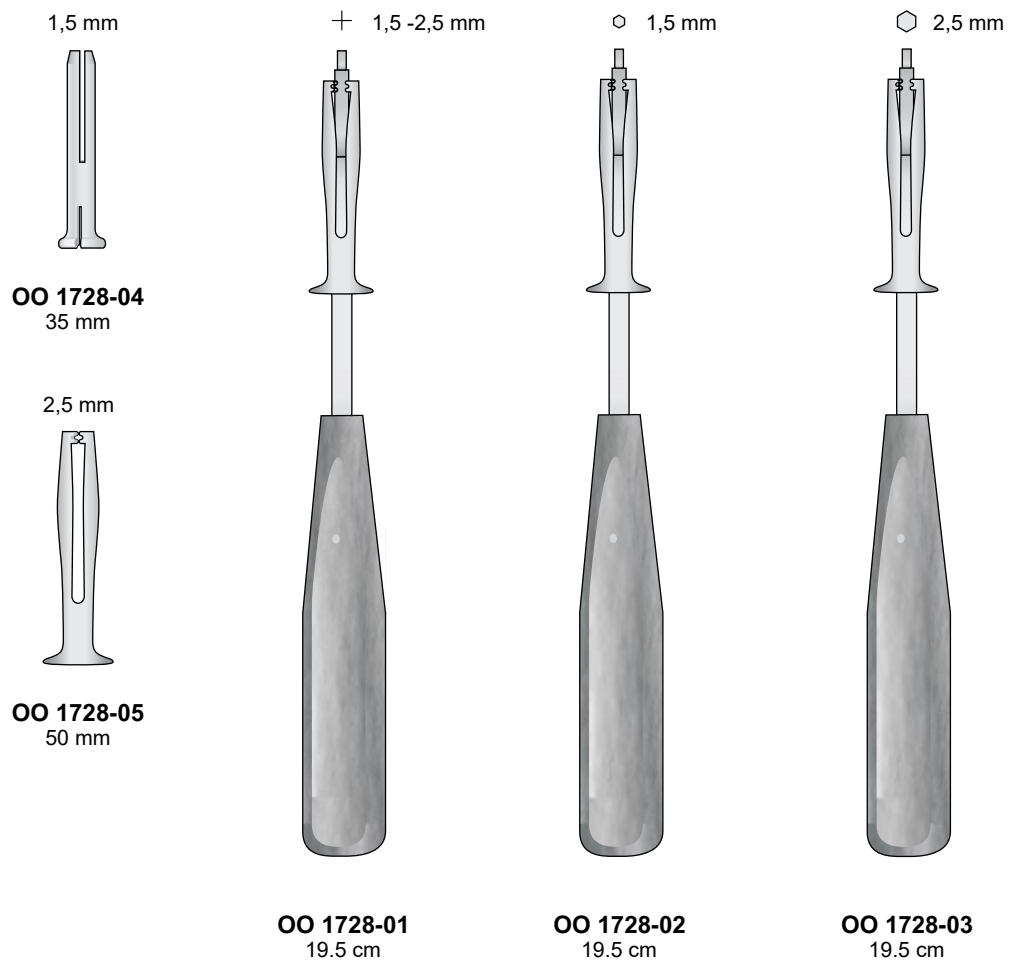

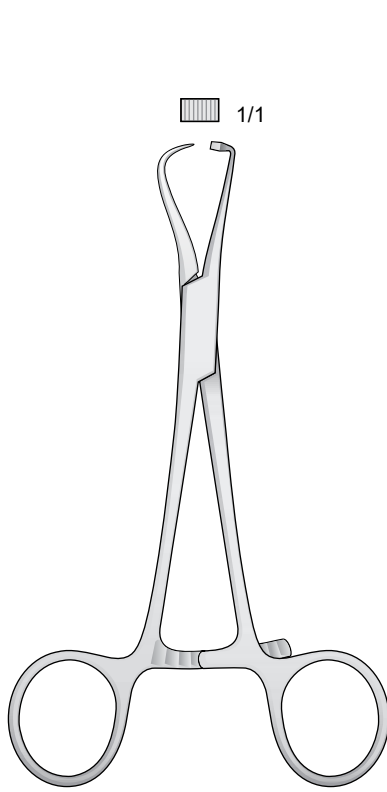

ZSP 1729-12 12 cm

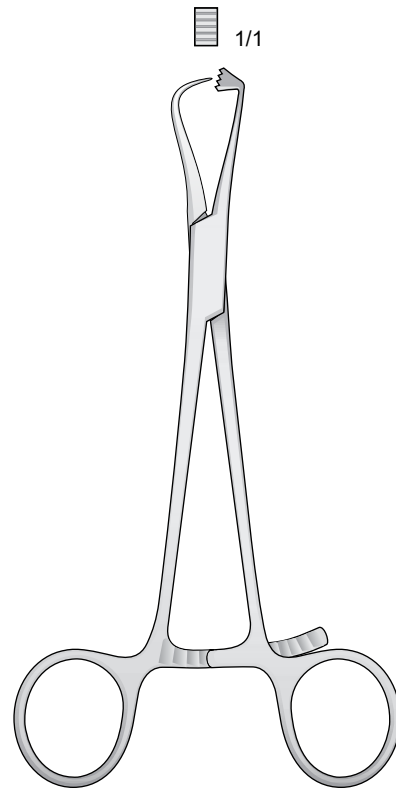

ZSP 1730-12 12.5 cm

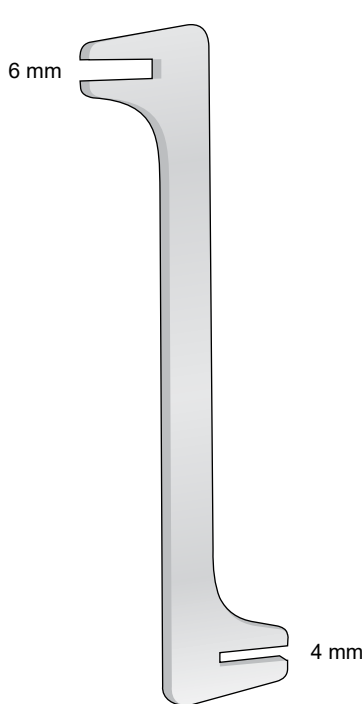

ZSP 1731-18 18 cm

Per placche da
2,7 mm e 3,5 mm



ZSP 1732-10 10 cm
ZSP 1732-14 14 cm



ZSP 1733-10 10 cm
ZSP 1733-14 14 cm

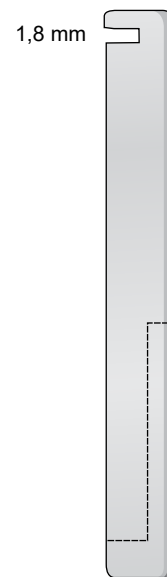

ZSP 1734-10 10 cm

Pinze per placche
Zangen für schränkhebel platten
Forceps for plattes
Pincès à courber pour plaques
Pinzas para placas

Pinze piegaplacche - Bending pliers - Biegezange - Pincès à plier

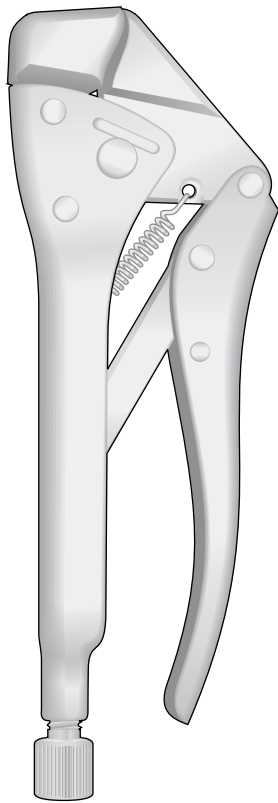

ZSP 1735-20 20 cm



ZSP 1736-24 24 cm

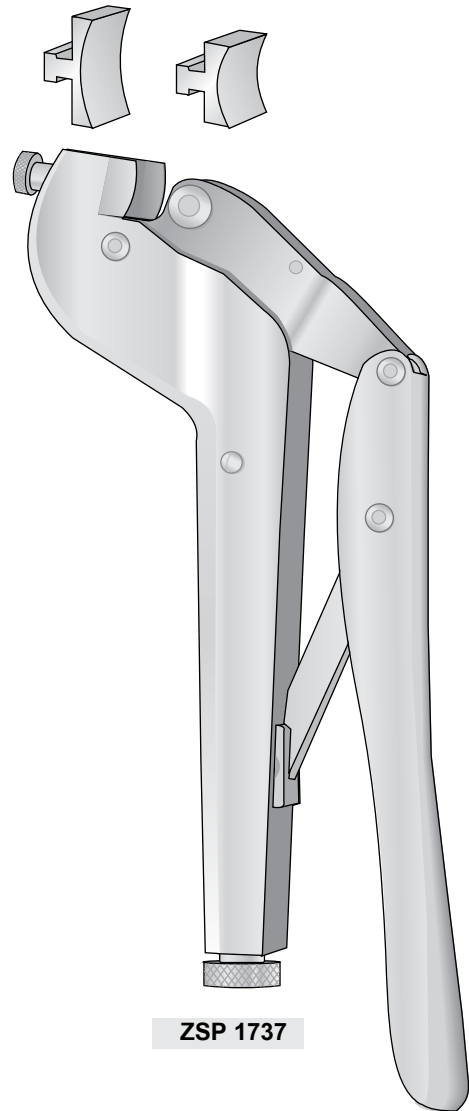

ZSP 1737

Pressa piegaplacche - Bending press - Biegepresse - Presse pour plier

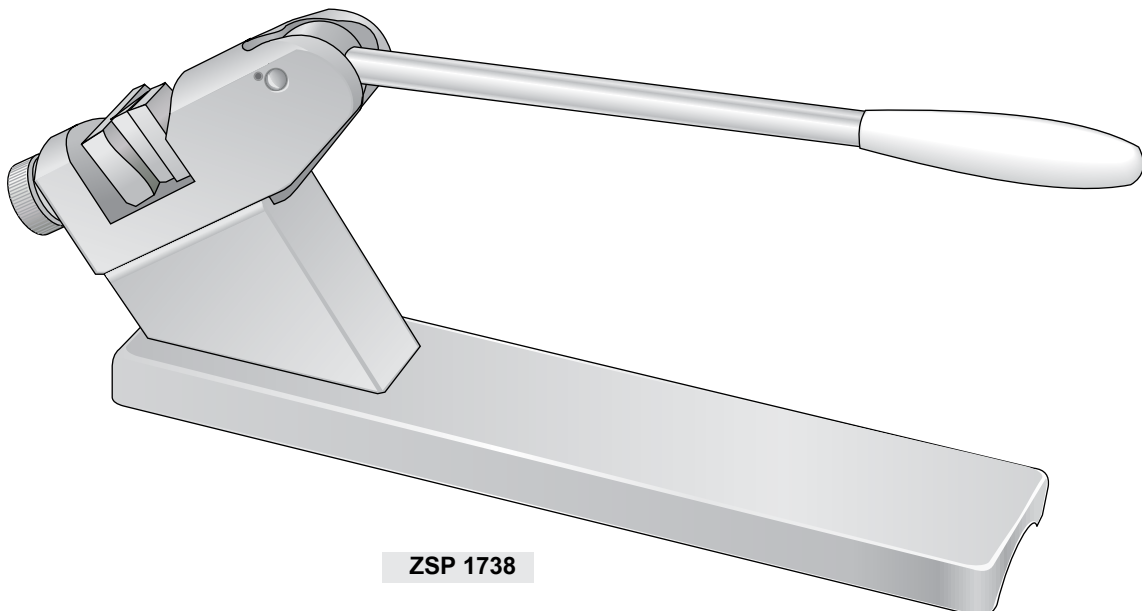

ZSP 1738

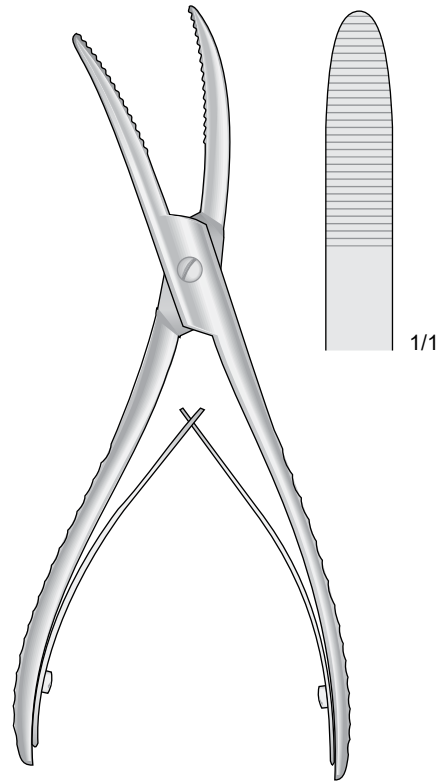

1/1

WOLFF

PCB 1739-18 18 cm

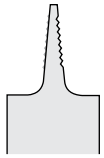
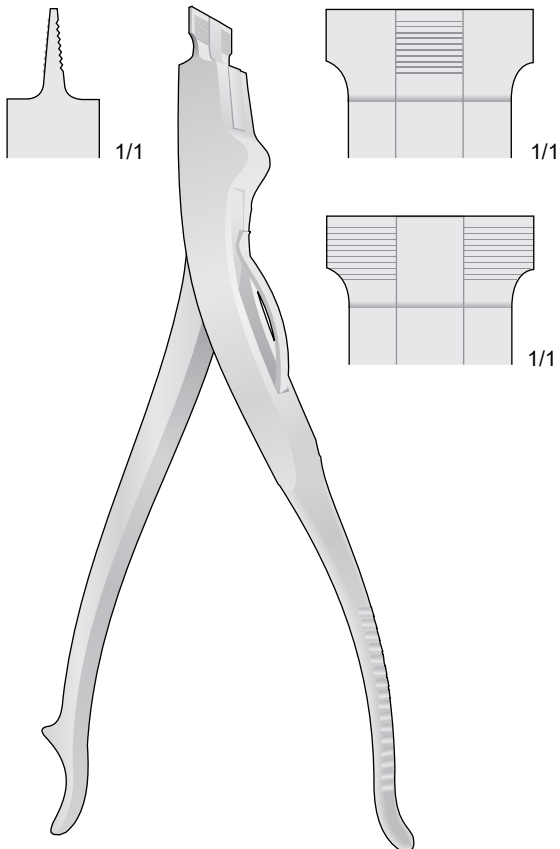

1/1

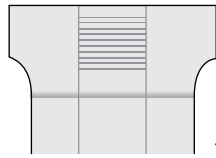

1/1

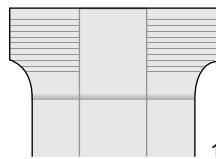

1/1

LAWTON

PCB 1740-22 22 cm

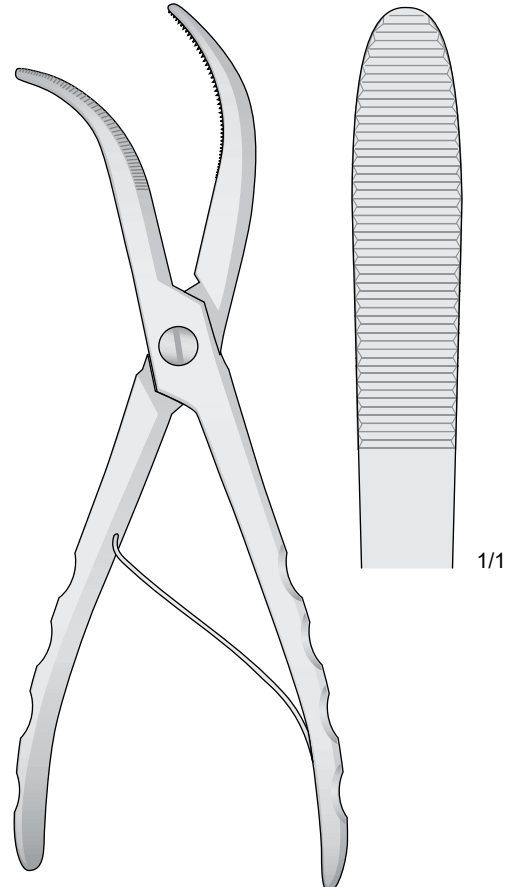

1/1

WOLFF

PCB 1741-25 25 cm

Cesoie per gesso
 Gips - Schneidezangen

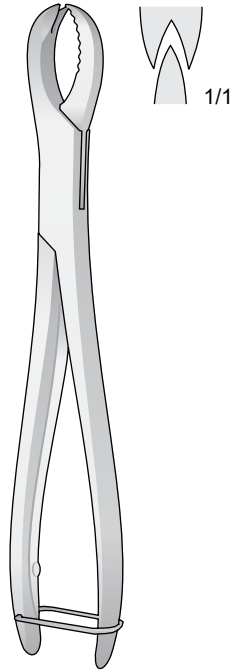

PCB 1742-21 21 cm

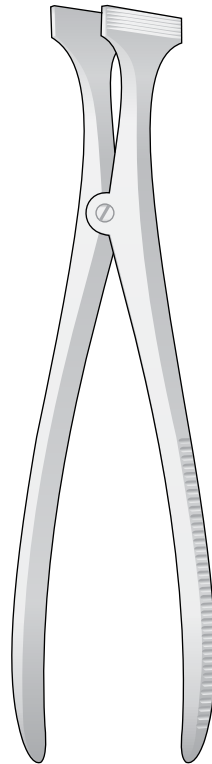

HENNIG
PCB 1743-27 27 cm

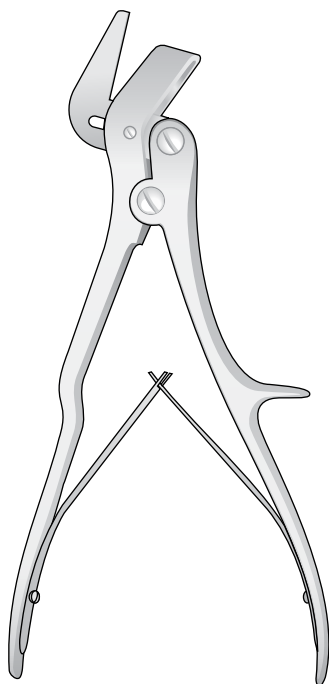
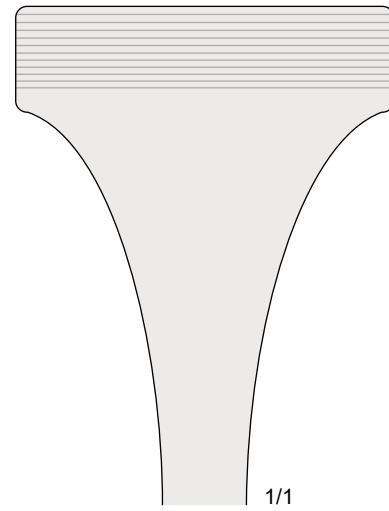

STILLE
PCB 1744-23 23 cm

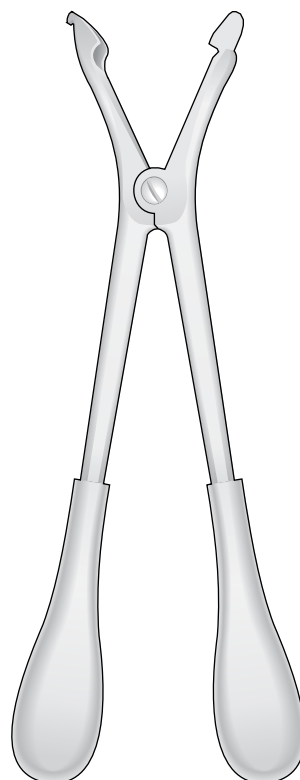

HAGLUND
PCB 1745-28 28 cm

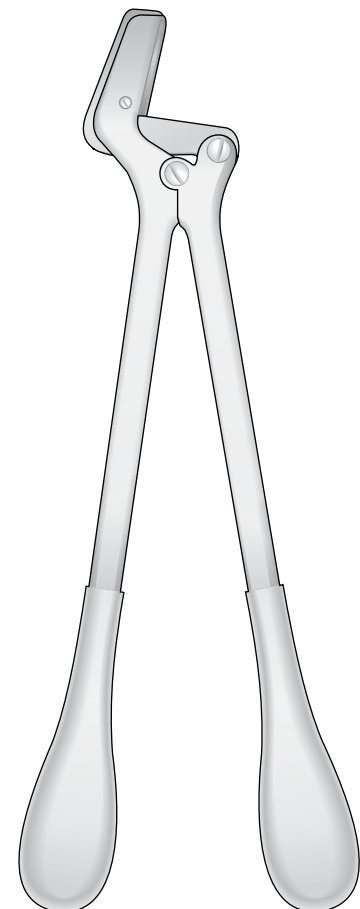

STILLE
PCB 1746-37 37 cm



we take a closer look

ENT Otolaryngology



HNO - Heilkunde
ORL - Oto-rhino-laryngologie
ORL - Otorrinolaringología
ORL - Otorinolaringoiatria

Per adulti - For adults
Für Erwachsene - Pour adultes
Para adultos

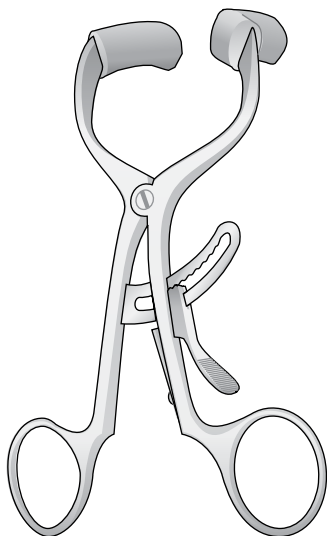

DOYEN-JANSEN
MG 1780-14 14 cm

Per adulti - For adults
Für Erwachsene - Pour adultes
Para adultos

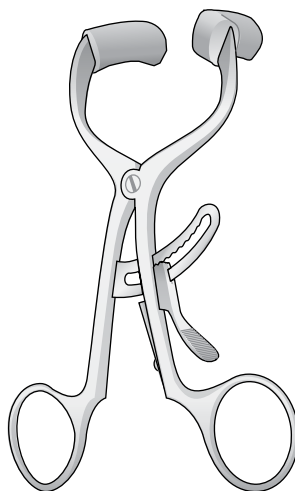

DOYEN-COLLIN
MG 1781-12 12 cm

Per bambini
For children
Für kinder
Pour enfants
Para niños

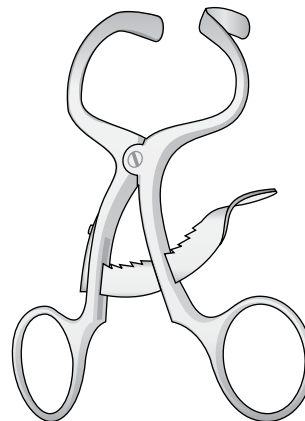

MOLT
MG 1782-10 10 cm

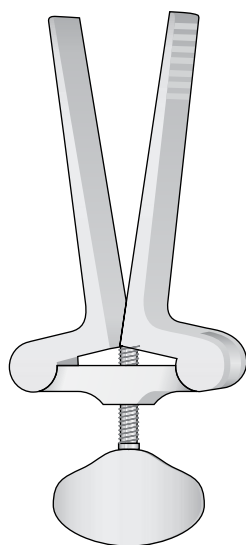

HEISTER
MG 1783-13 13.5 cm

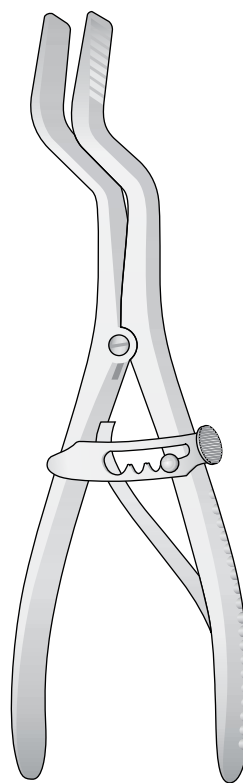

ROSER KÖNIG
MG 1784-18 18.5 cm

Apribocca con aspirazione
Mouth gag with suction
Mundsperrer mit Absauger

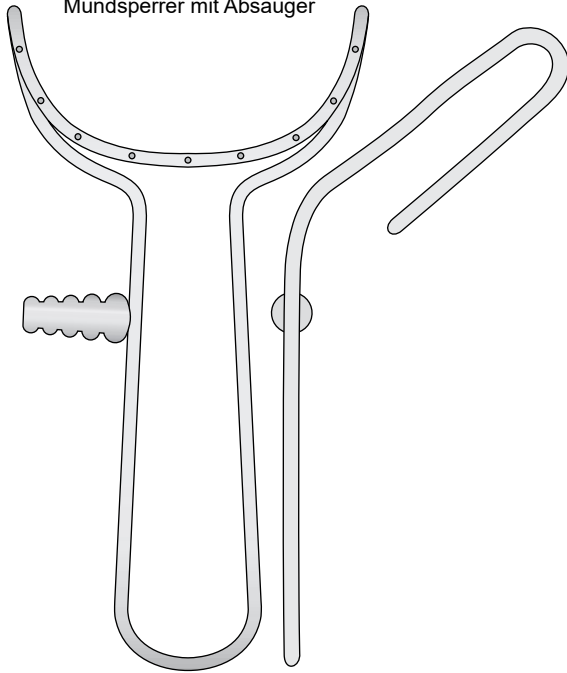

MG 1785-14 14 cm

Apribocca senza aspirazione
Mouth gag without suction
Mundsperrer ohne Absauger

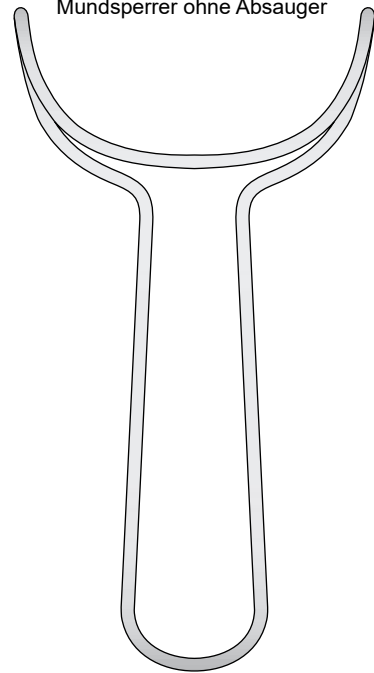

MG 1786-15 15 cm

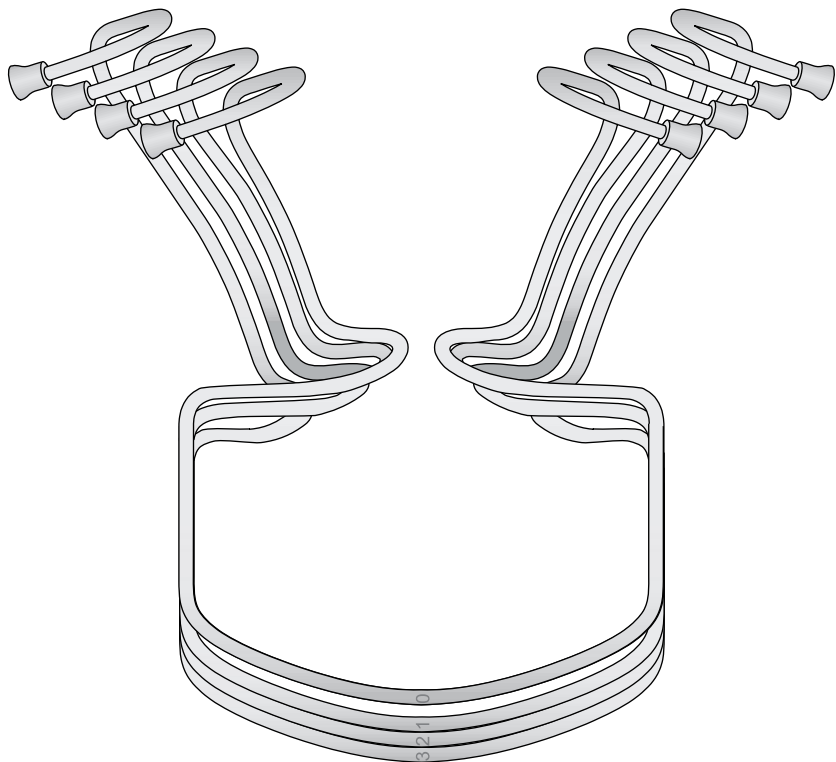
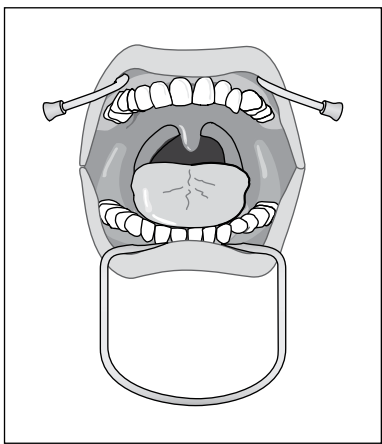

ORINGER

- | | | |
|-------------------|---------------------|-------------|
| MG 1787-01 | Fig. 0 100 x 95 mm | Per bambini |
| MG 1787-02 | Fig. 1 115 x 105 mm | Per adulti |
| MG 1787-03 | Fig. 2 115 x 110 mm | Per adulti |
| MG 1787-03 | Fig. 3 125 x 115 mm | Per adulti |

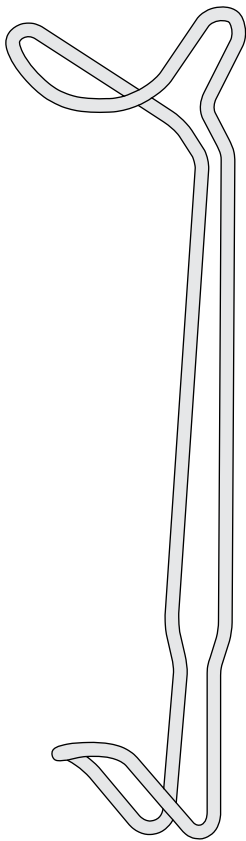

R 1788-21 21 cm

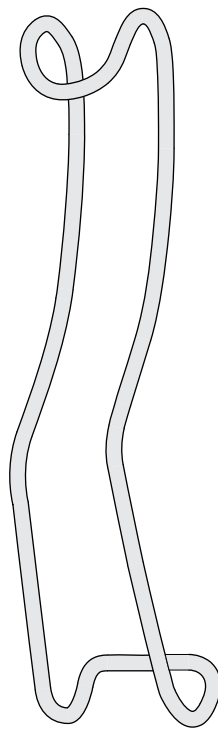

STERNBERG
R 1789-16 16 cm

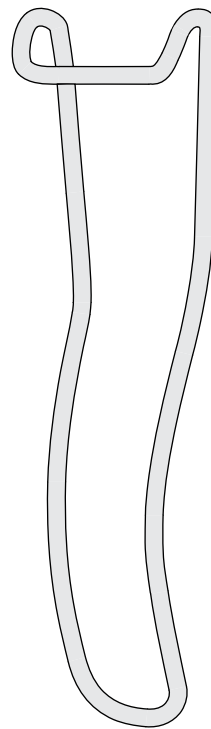

STERNBERG
R 1790-16 16 cm

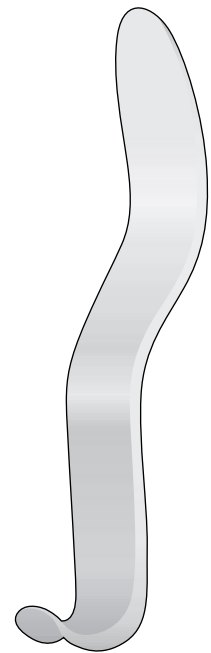

MINNESOTA
R 1791-14 14 cm

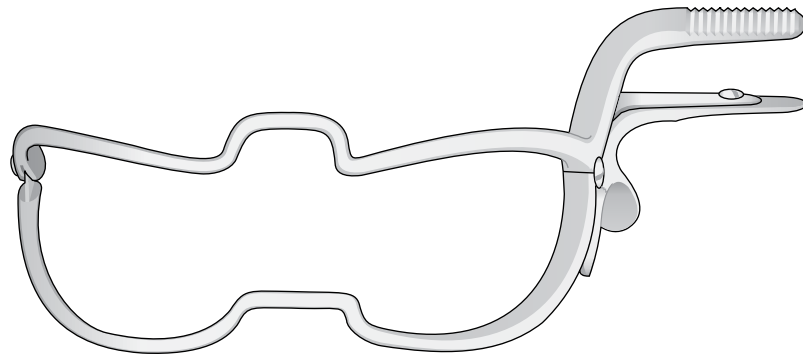

WHITEHEAD-JENNINGS

Code	Size
MG 1792-09	9 cm
MG 1792-11	11 cm
MG 1792-13	13 cm
MG 1792-15	15 cm

Apribocca solo
Gag only
Sperrer allein
Manche et cadreseuls
Apre-boca suelto

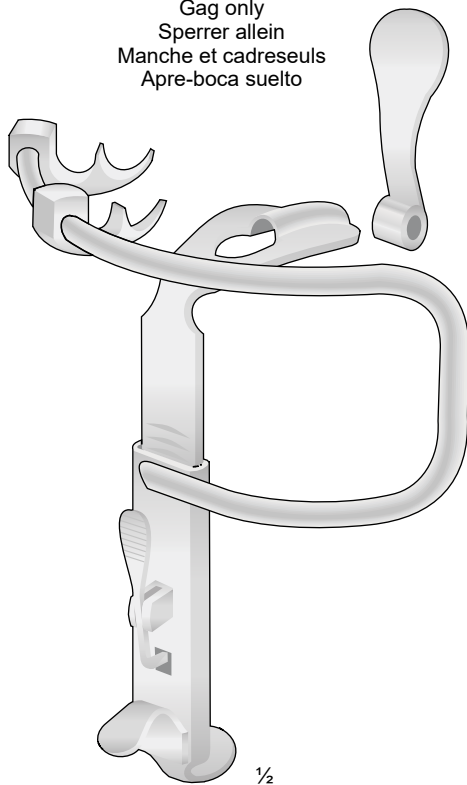

KILNER-DOUGHTY
MG 1793

Fig. 1

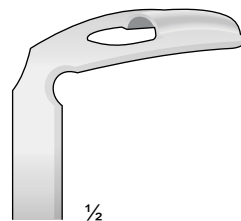

MG 1793-01
28 x 65 mm

Fig. 2

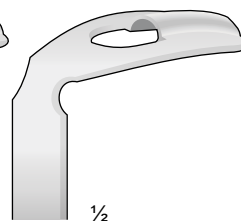

MG 1793-02
32 x 75 mm

Fig. 3

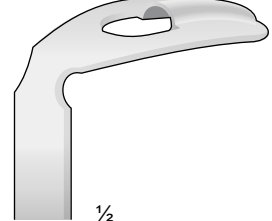

MG 1793-03
37 x 80 mm

KILNER-DOUGHTY

MG 1794

Completo con 3 abbassalingua
Complete with 3 tongue depressors
Komplet mit 3 Zungenspatel
Complet avec 3 abaisse-langues
Completo con 3 abaja lengua

Apribocca
 Mouth gags
 Mundsperrer
 Ecarteur buccal
 Abrebocas

Apribocca solo
 Gag only
 Sperrer allein
 Manche et cadreseuls
 Apre-boca suelto

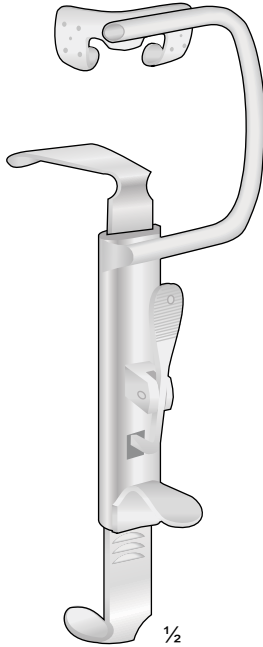

DAVIS-BOYLE
 MG 1795

DAVIS-BOYLE
MG 1796
 Completo con 5 abbassalingua
 Complete with 5 tongue depressors
 Komplet mit 5 Zungenspatel
 Complet avec 5 abaisse-langues
 Completo con 5 abaja lengua

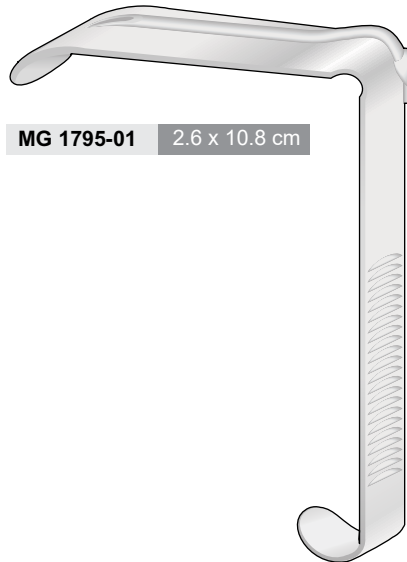

MG 1795-01 2.6 x 10.8 cm



MG 1795-02 2.5 x 9.3 cm



MG 1795-03 2.4 x 8 cm

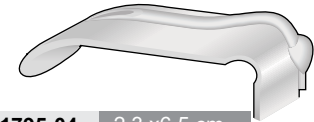

MG 1795-04 2.3 x 6.5 cm

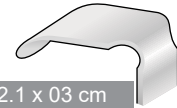

MG 1795-05 2.1 x 03 cm

Mc-IVOR
MG 1798
 Completo di 3 abbassalingua
 Complete with 3 tongue depressors
 Komplet mit 3 Zungenspatel
 Complet avec 3 abaisse-langues
 Completo con 3 abaja lengua

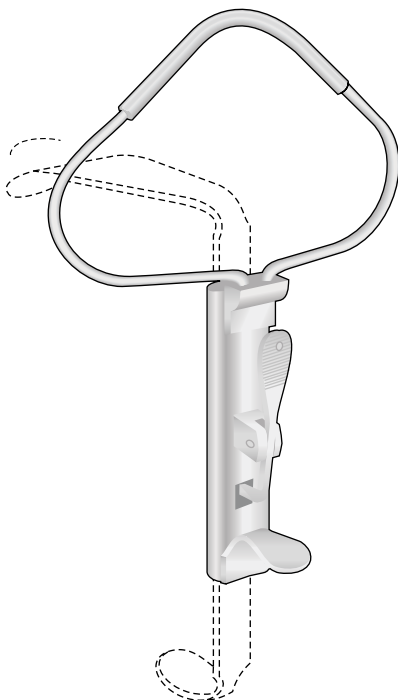

Mc-IVOR
 MG 1797

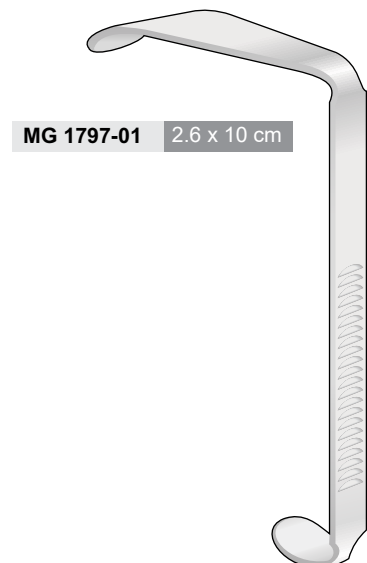

MG 1797-01 2.6 x 10 cm

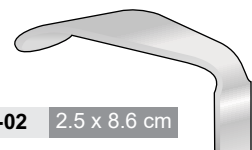

MG 1797-02 2.5 x 8.6 cm

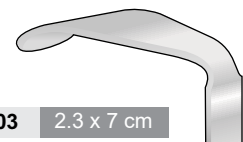

MG 1797-03 2.3 x 7 cm

Telaio Dingmann con
due apriguancia

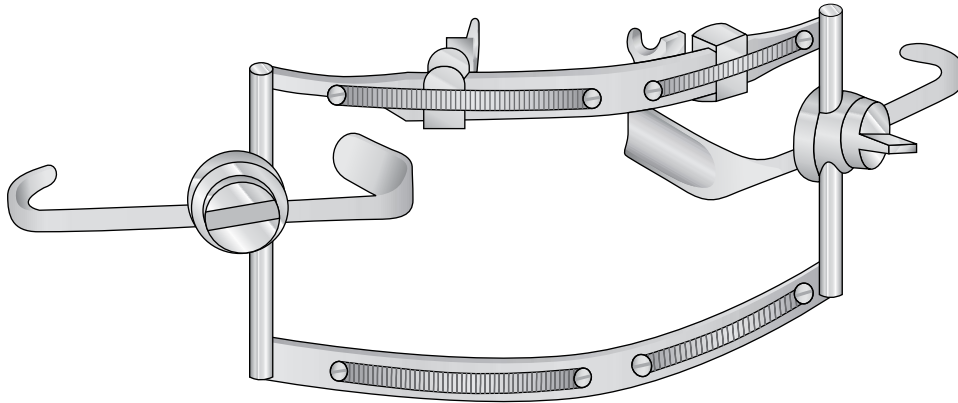

MG 1799-01

Abbassalingua
Tongue depressor
Zungenspatel
Abaisse langues
Bejalenguas

Fig. 1

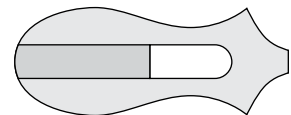

MG 1799-02
piccolo

Fig. 2

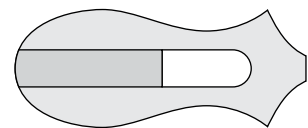

MG 1799-03
medio

Fig. 3

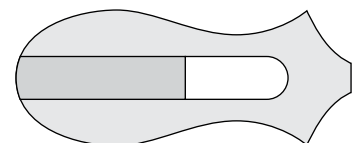

MG 1799-04
grande

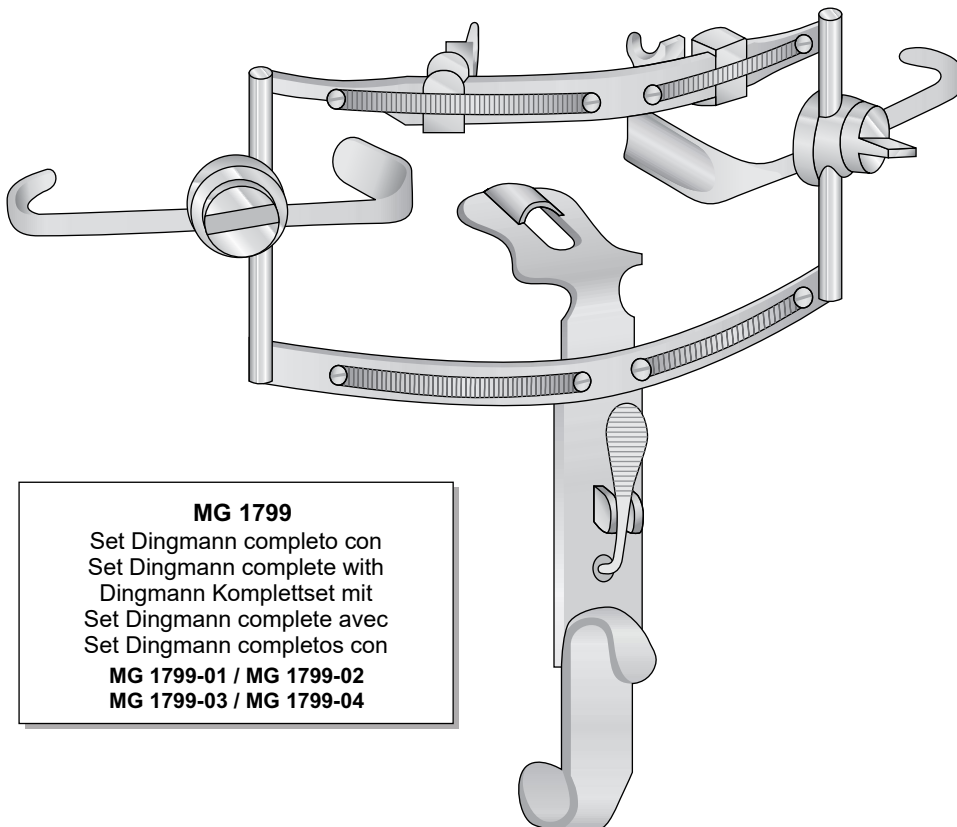

MG 1799
Set Dingmann completo con
Set Dingmann complete with
Dingmann Kompletset mit
Set Dingmann complete avec
Set Dingmann completos con
MG 1799-01 / MG 1799-02
MG 1799-03 / MG 1799-04

DINGMANN
MG 1799
Set completo

Spatole malleabil
 Spatulas malleable
 Biigsame Spatel
 Spatules flexibl
 Epatulas flexible



SM 1800-11 11 cm

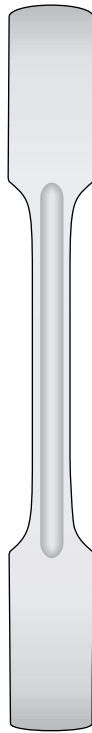

SM 1801-16 16 cm



SM 1802-19 19.5 cm

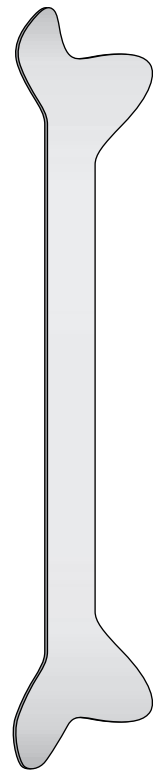

SM 1803-18 18 cm

Spatole inox malleabili
 Spatulas malleable

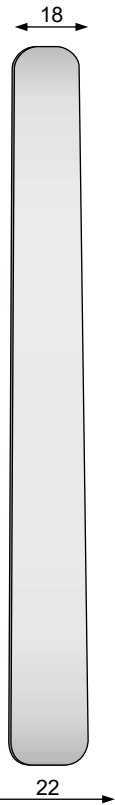

SM 1804-20 20 cm



SM 1805-20 20 cm



SM 1806-24 24 cm

Spatole Inox malleabili antiriflesso nere
 Spatulas malleable black anodized



SM 1807-20 20 cm

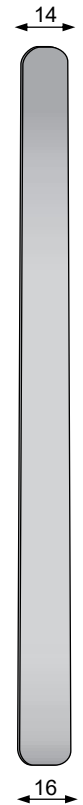

SM 1808-20 20 cm



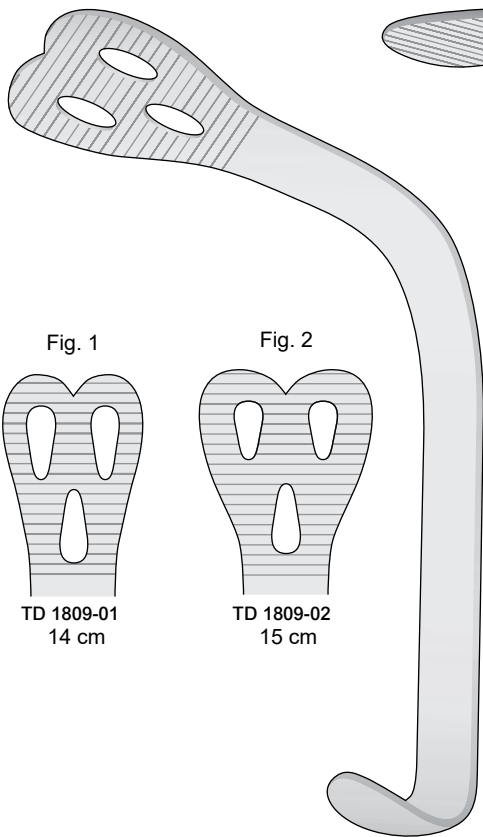
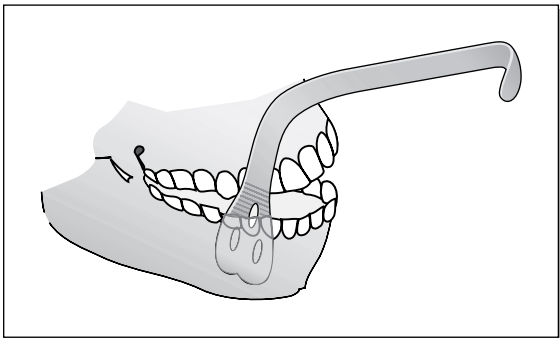

Fig. 1

Fig. 2

TD 1809-01
14 cm

TD 1809-02
15 cm

WIEDER

TD 1809-01 / TD 1809-02

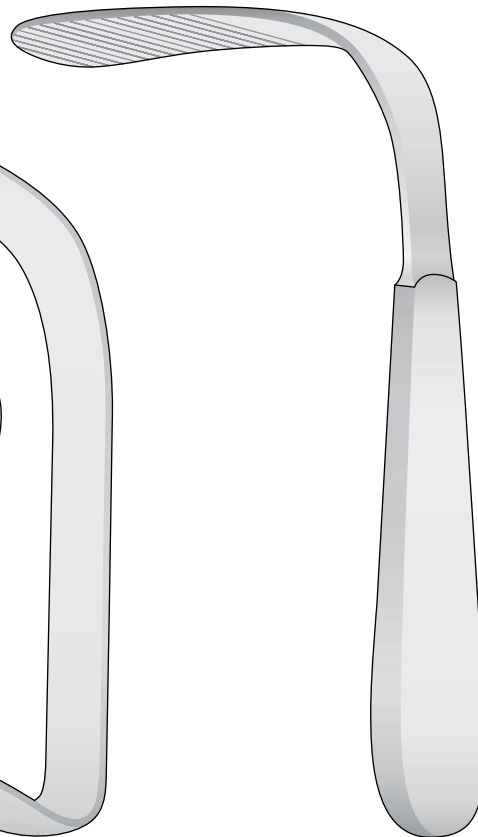

TOBOLD

TD 1810-14 14.5 cm

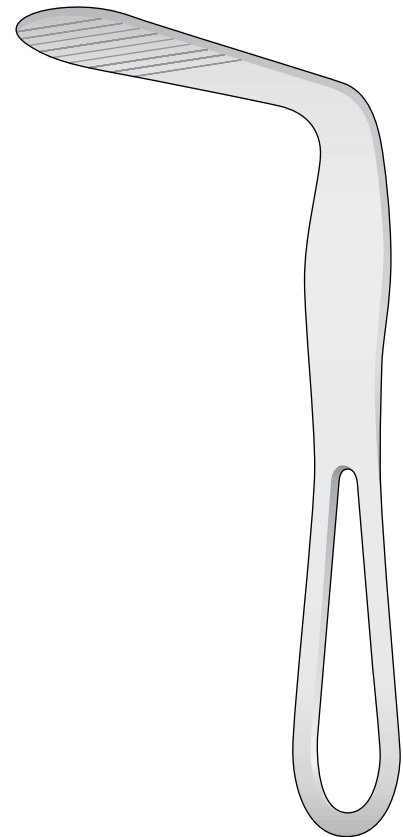

HARTMANN

TD 1811-15 15 cm

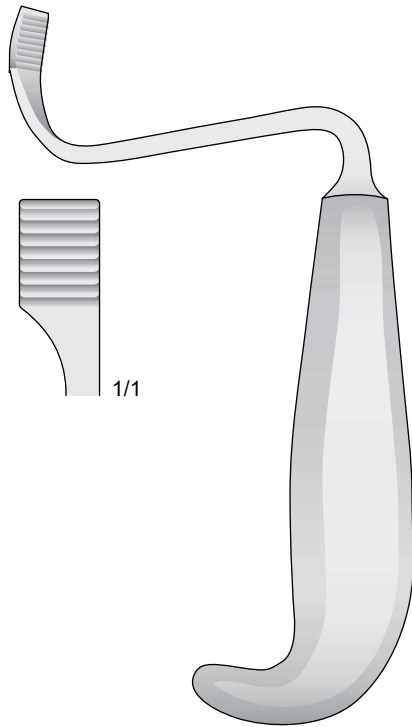

TESSIER
R 1812-15 15 cm

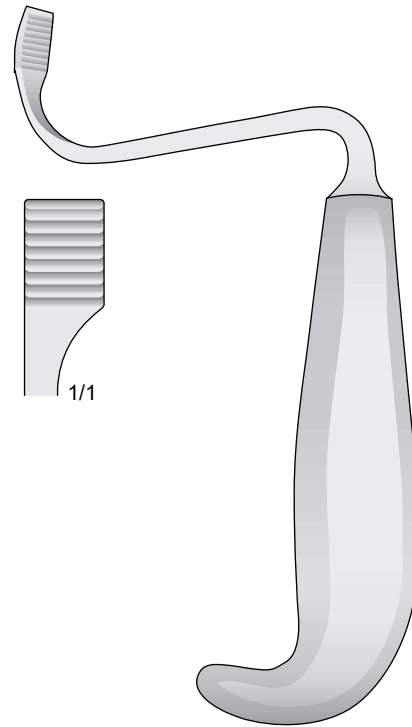

TESSIER
R 1813-15 15 cm

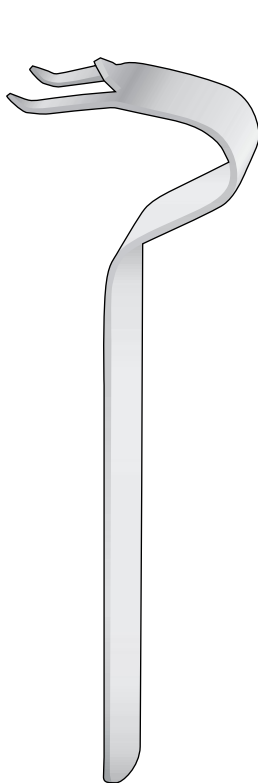

OBWEGESER
R 1814-15 15.5 cm

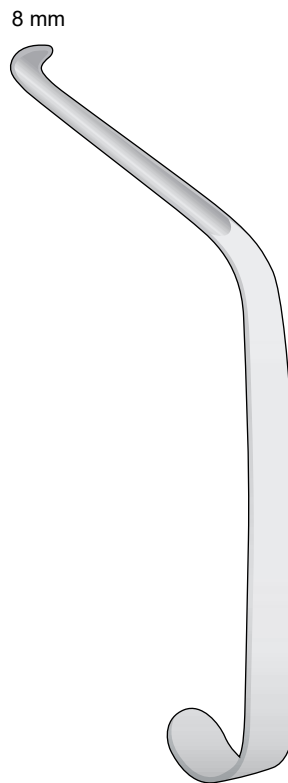

OBWEGESER
R 1815-16 16.5 cm

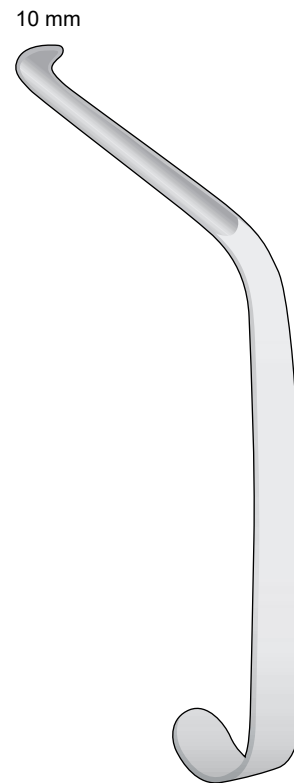

OBWEGESER
R 1816-16 16.5 cm

6 x 13 mm

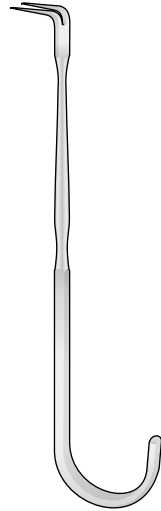

DUNN-DAUTREY

R 1817-13 13 cm

8 x 18 mm

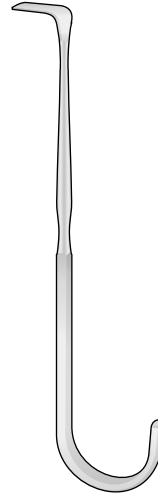

DUNN-DAUTREY

R 1818-12 12.5 cm

Posteriore

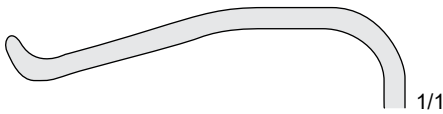

Anteriore

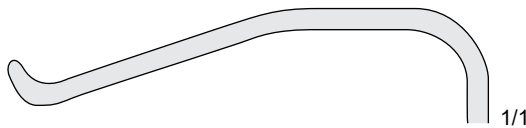

Superiore

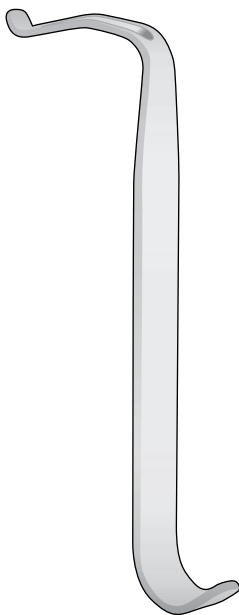

DUNN-DAUTREY

R 1819-14 14 cm
6,5 x 50 mm

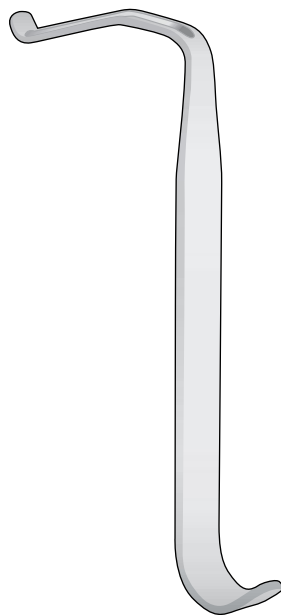

DUNN-DAUTREY

R 1820-14 14 cm
6,5 x 60 mm

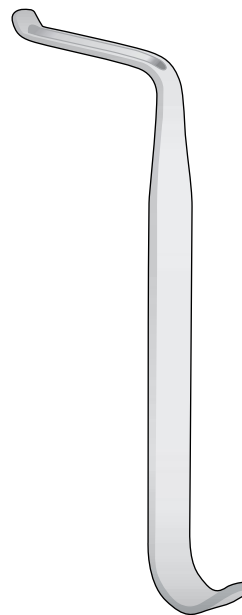

DUNN-DAUTREY

R 1821-14 14 cm
8 x 50 mm

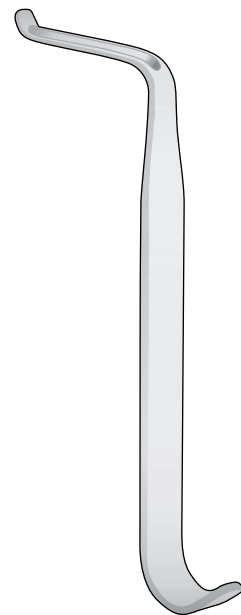

DUNN-DAUTREY

R 1822-14 14 cm
6,5 x 50 mm

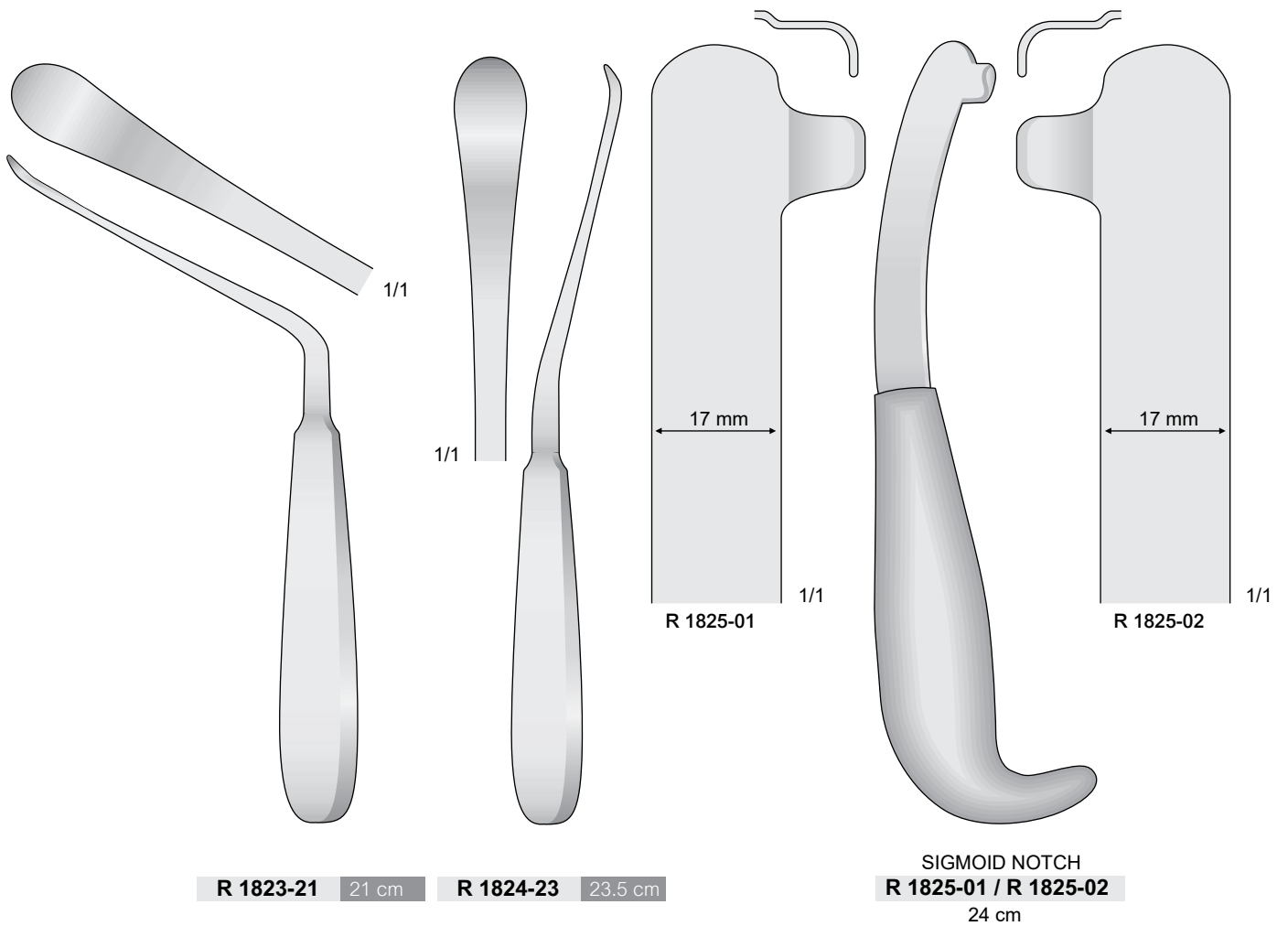

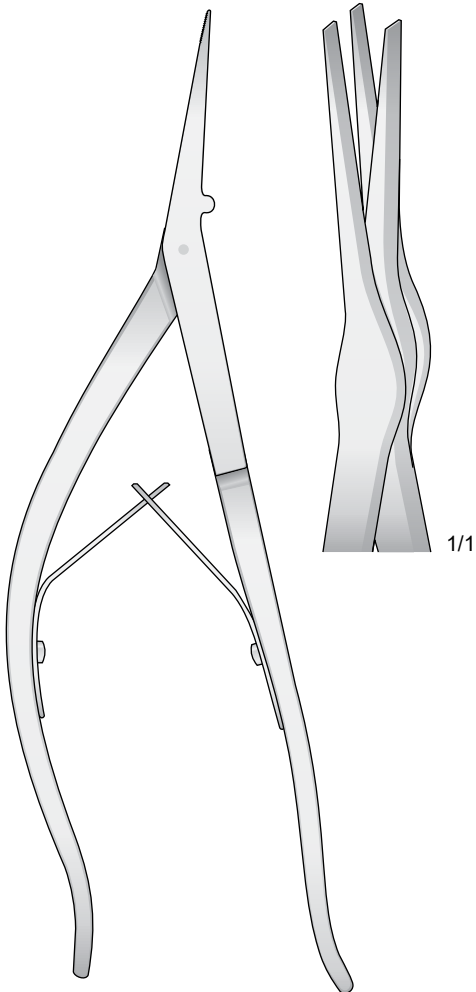
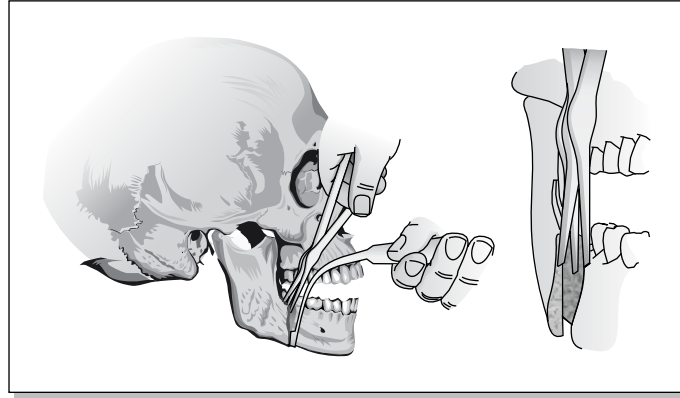

RAMUS
BHF 1826-23 23 cm

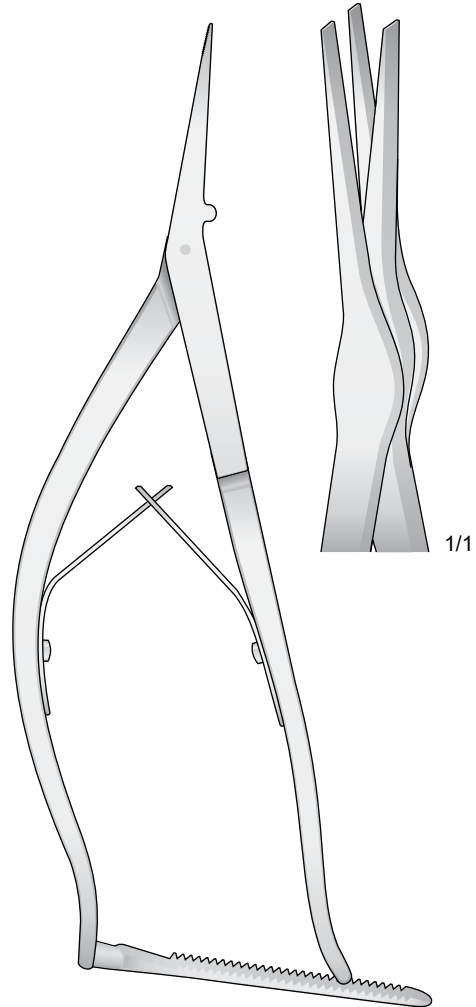

RAMUS
BHF 1827-23 23 cm

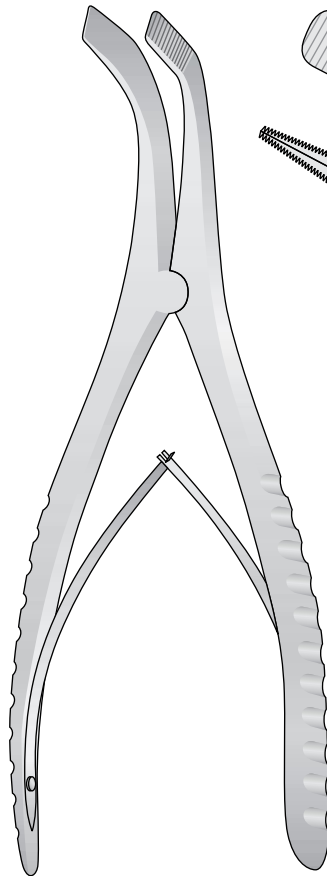
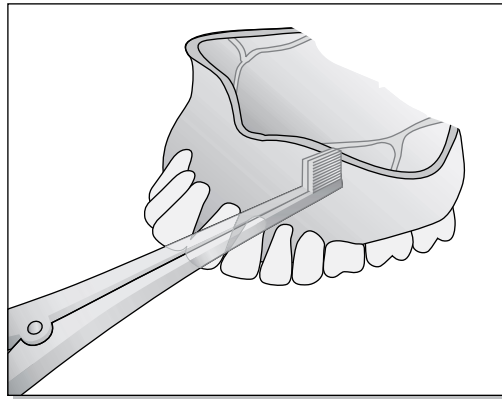

TESSIER

BHF 1828-18 18 cm

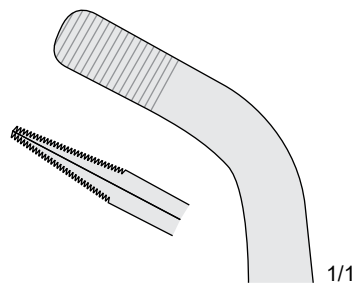

Maxillary expander

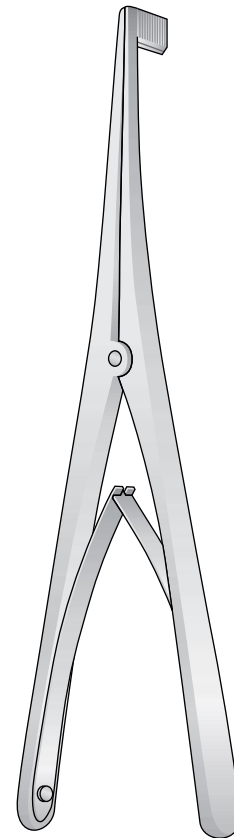

BHF 1829-17 17 cm

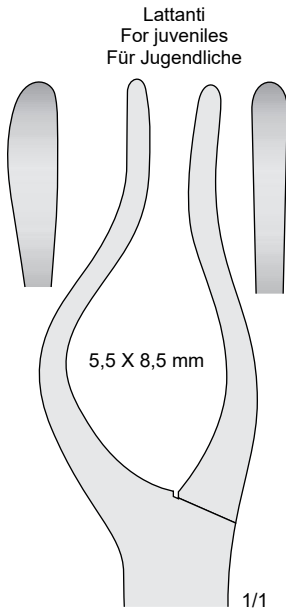

RF 1830-01	22.5 cm
RF 1830-02	22.5 cm

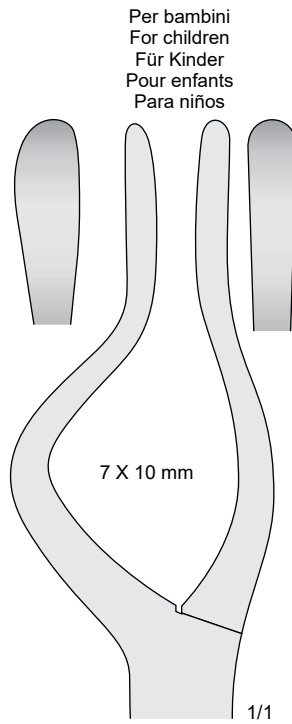

RF 1831-01	23.5 cm
RF 1831-02	23.5 cm

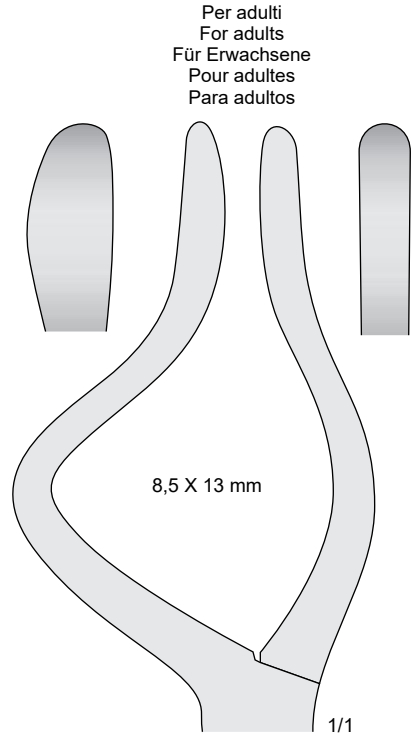

RF 1832-01	24 cm
RF 1832-02	24 cm

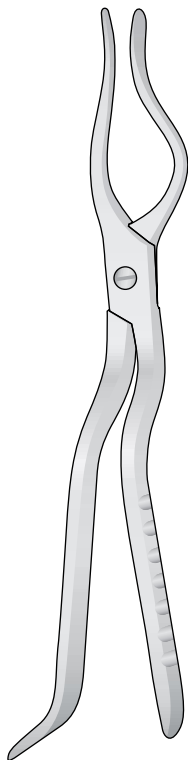

ROWE



ROWE

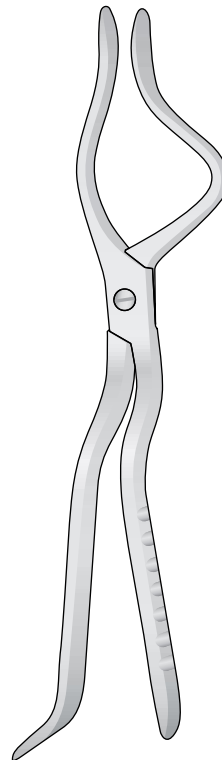

ROWE

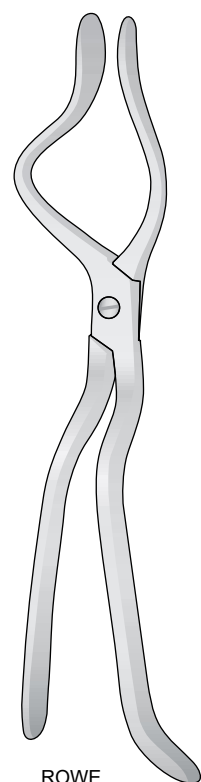

ROWE

Uncini

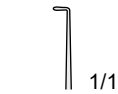
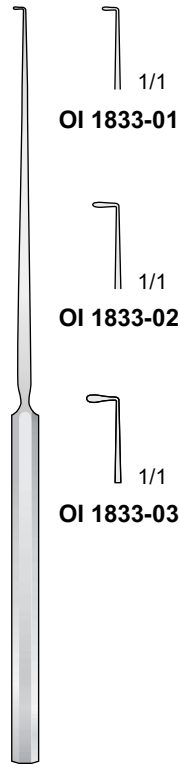

OI 1833-01



OI 1833-02

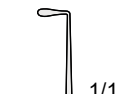

OI 1833-03

LUCAE
 OI 1833-01 / OI 1833-03
 14 cm

Curette - Curettes - Löffel - Curettes - Curetas



OI 1834-01



OI 1834-02



OI 1834-03



OI 1834-04

SHAPLEIGH
 OI 1834-01 / OI 1834-04
 13 cm

Uncini

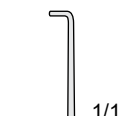

OI 1835-01

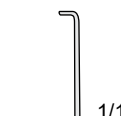

OI 1835-02

DAY
 OI 1835-01 / OI 1835-02
 16 cm

Anse auricolari - Ear loops anses - Ohrschlingen - Ansas auriculares



OI 1836-01



OI 1836-02

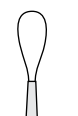

OI 1836-03

BILLEAU
 OI 1836-01 / OI 1836-03
 16 cm

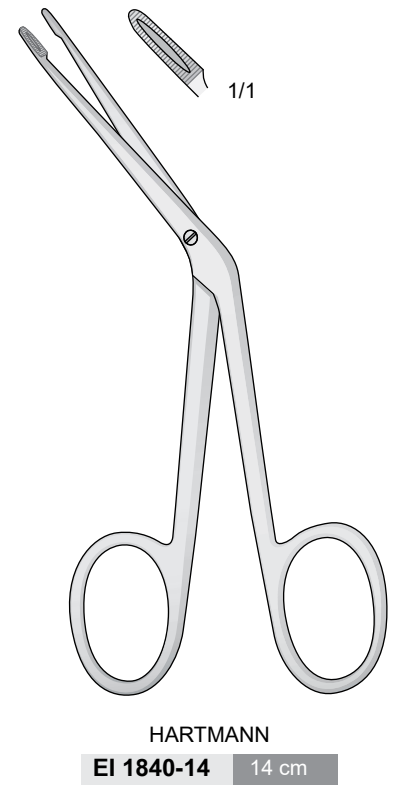
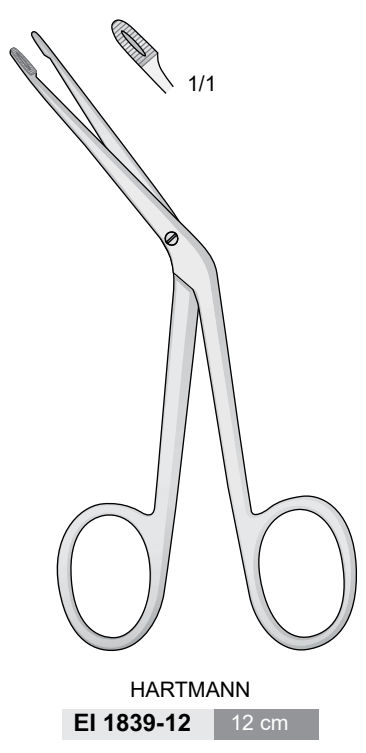
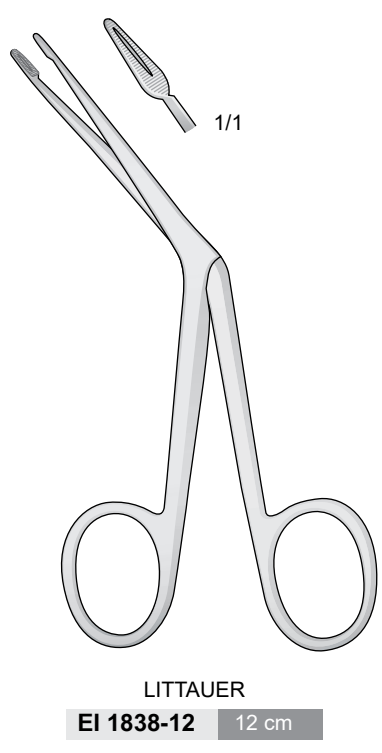
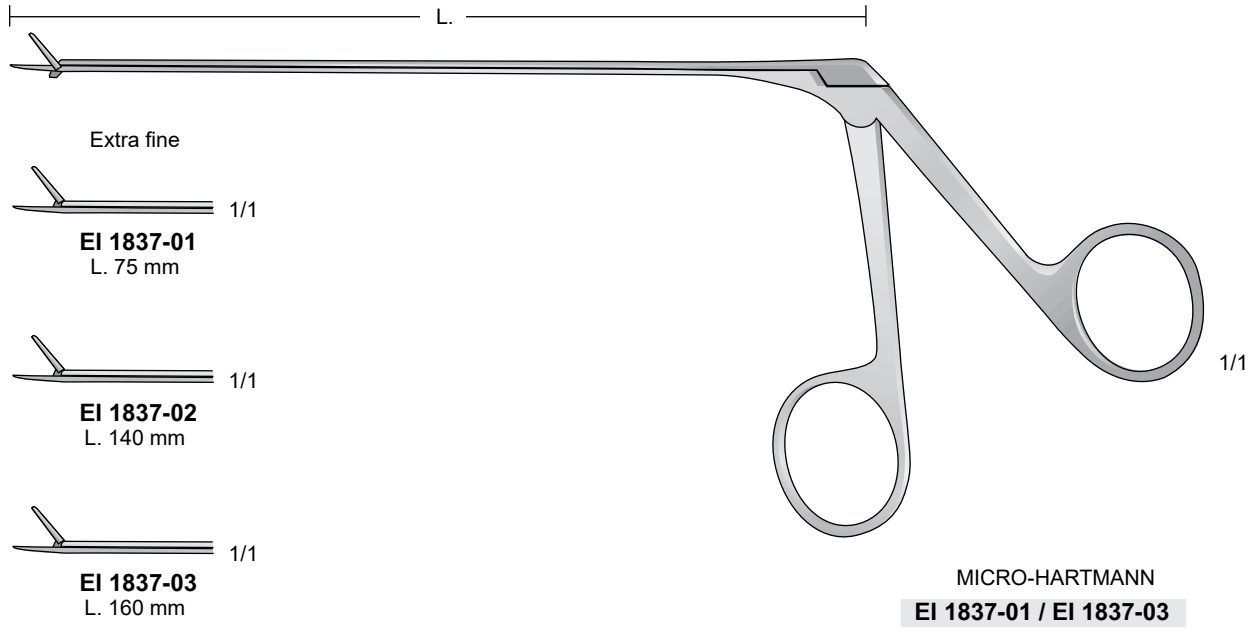

Pinze auricolari
Ear Forceps
Ohr-Polypenzangen
Pinces pour polypes auriculaires
Pinzas auricolàres

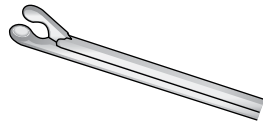

EI 1841-01
L.85 mm

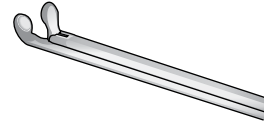

EI 1841-02
L.85 mm

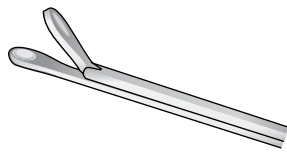

EI 1841-03
L.85 mm

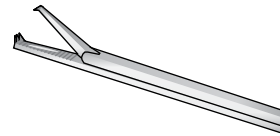

EI 1841-04
L.85 mm

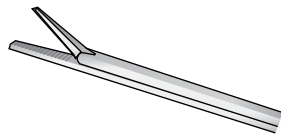

EI 1841-05
L.85 mm

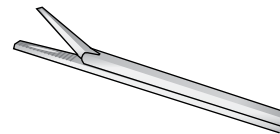

EI 1841-06
L.140 mm
EI 1841-07
L.165 mm

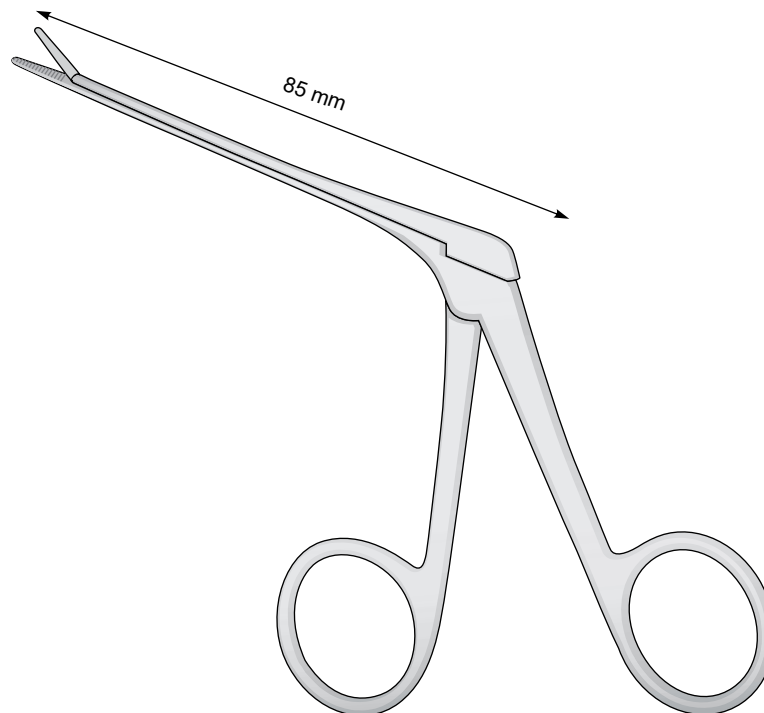

EI 1841-01 / EI 1841-07

L. 85 mm

Micro forbice
Micro scissor
Mikro Scheren
Micro ciseaux
Micro tijeras

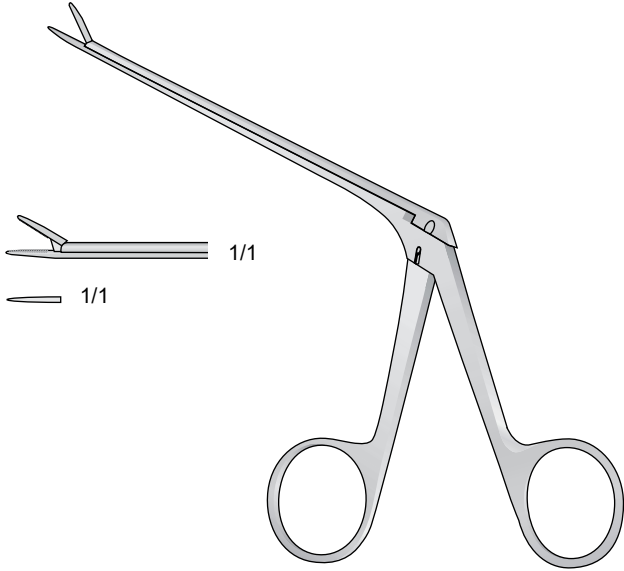

EI 1842-08 8 cm

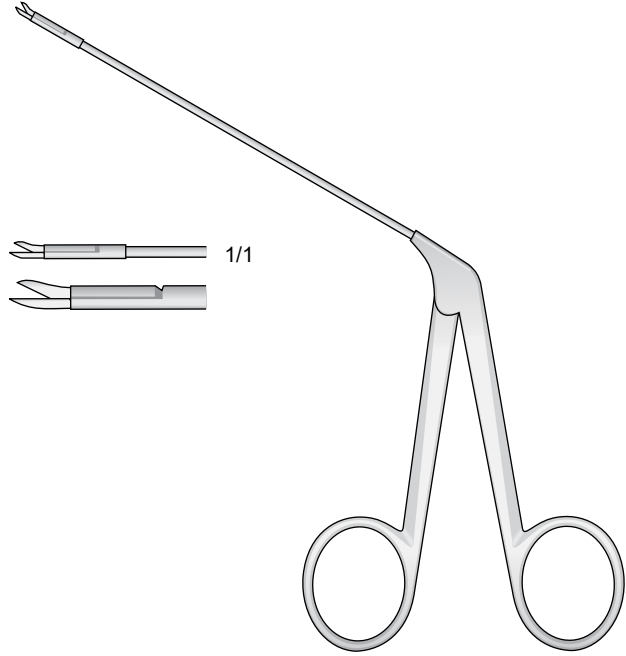

BELLUCCI
EI 1843-08 8 cm

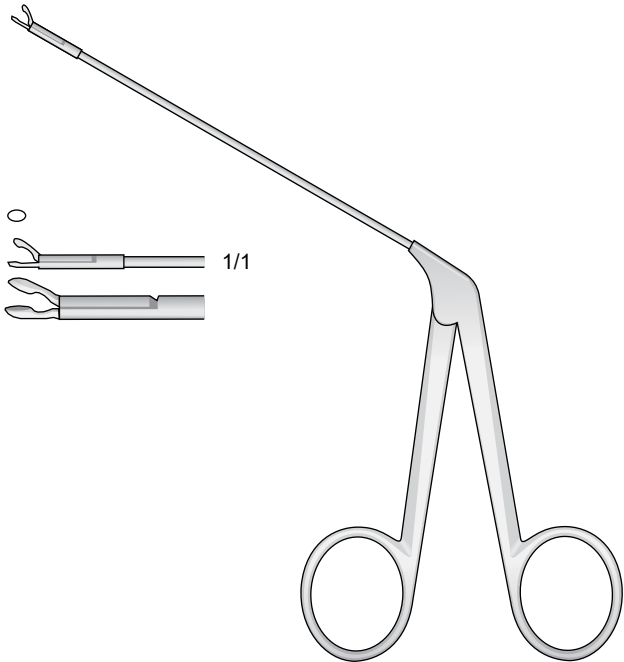

WULLSTEIN
EI 1844-08 8 cm

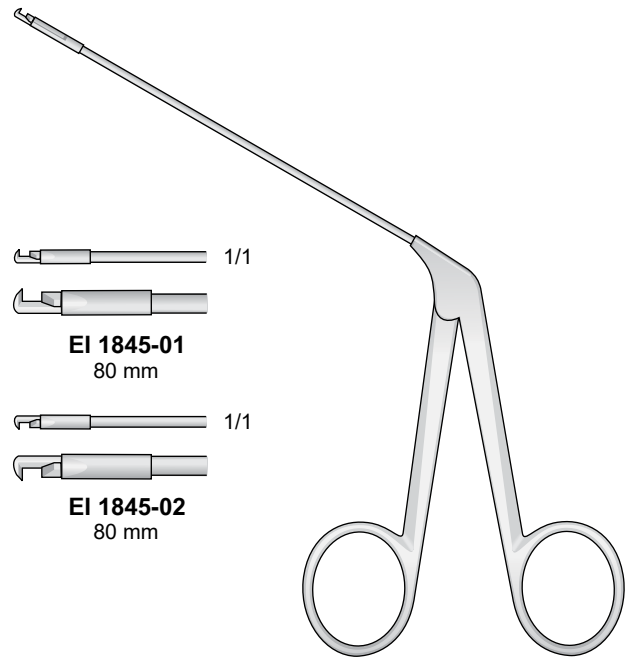

DIETER
EI 1845-01 / EI 1845-02
80 mm

Mikro-Schere

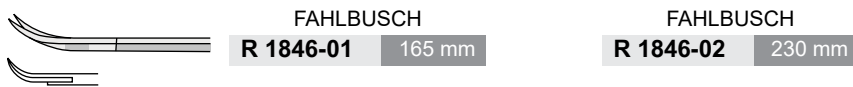

Scharfe Zange



Mikro-Schere

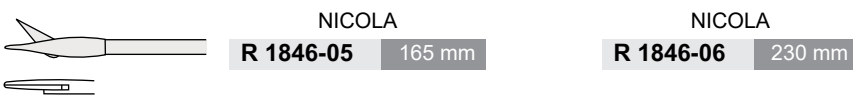

Faßzange

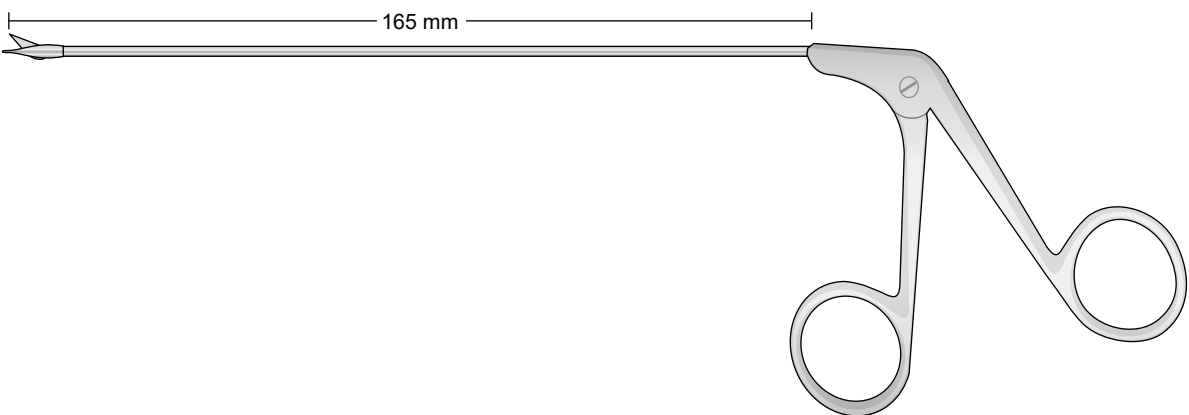
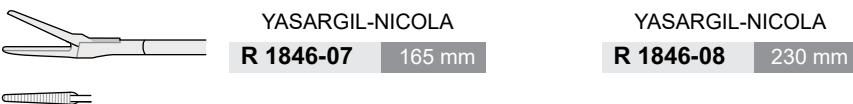

NICOLA
R 1846-01 / R 1846-08
16.5 cm

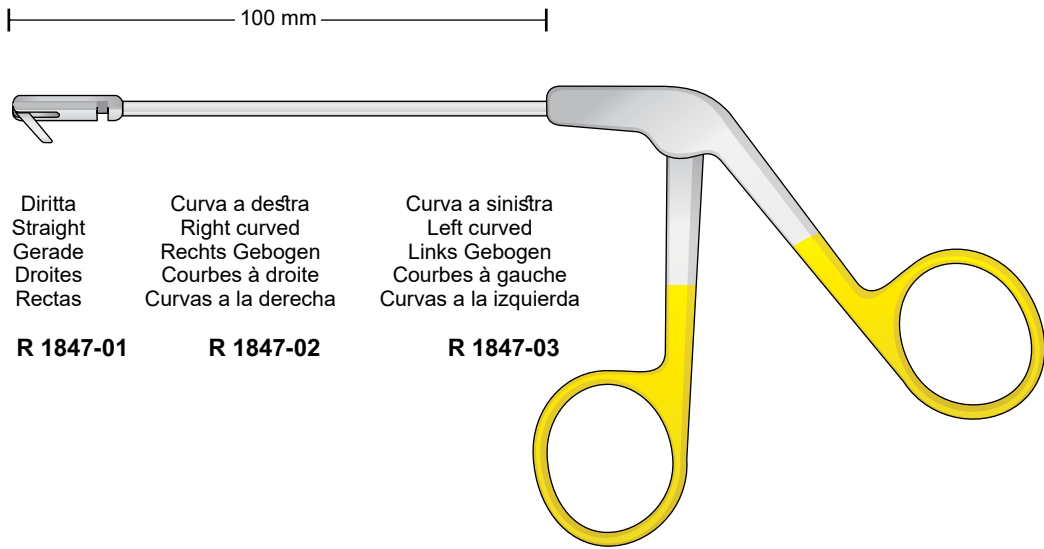

Diritta
Straight
Gerade
Droites
Rectas

R 1847-01

Curva a destra
Right curved
Rechts Gebogen
Courbes à droite
Curvas a la derecha

R 1847-02

Curva a sinistra
Left curved
Links Gebogen
Courbes à gauche
Curvas a la izquierda

R 1847-03

STAMBERGER

R 1847-01 / R 1847-03

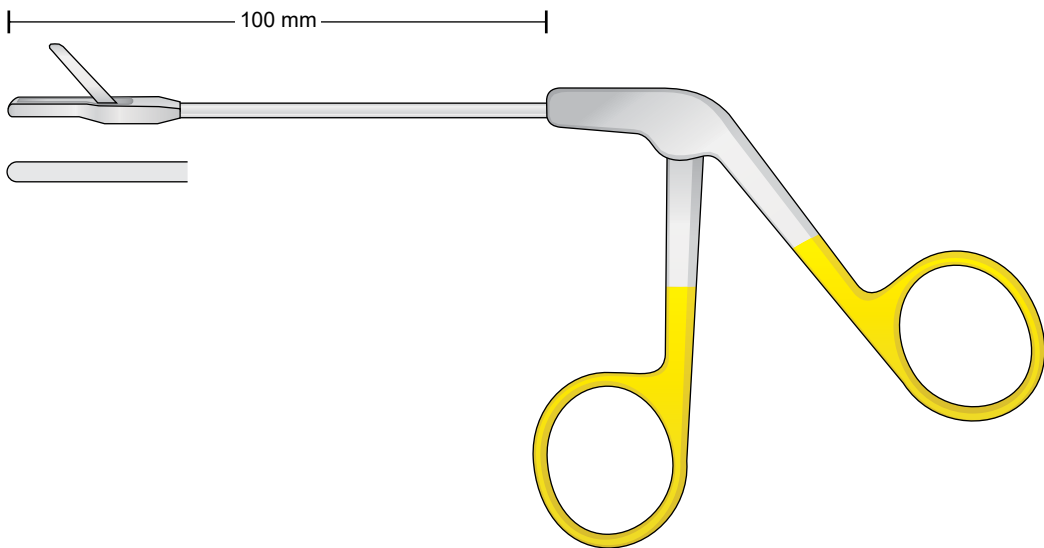

STRUYCKEN

R 1848-10 10 cm

130 mm

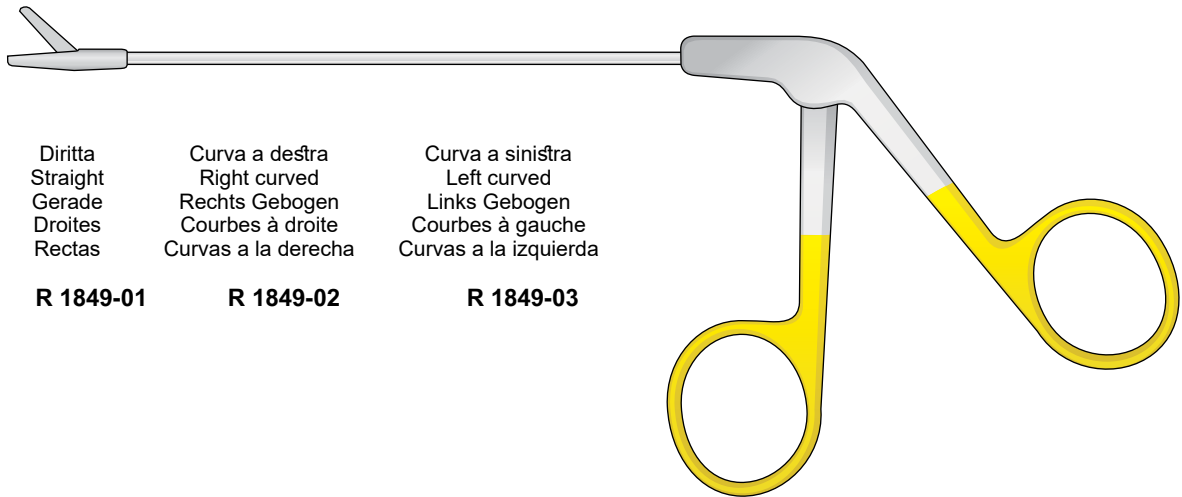

Diritta
 Straight
 Gerade
 Droites
 Rectas

R 1849-01

Curva a destra
 Right curved
 Rechts Gebogen
 Courbes à droite
 Curvas a la derecha

R 1849-02

Curva a sinistra
 Left curved
 Links Gebogen
 Courbes à gauche
 Curvas a la izquierda

R 1849-03

R 1849-01 / R 1849-03

140 mm

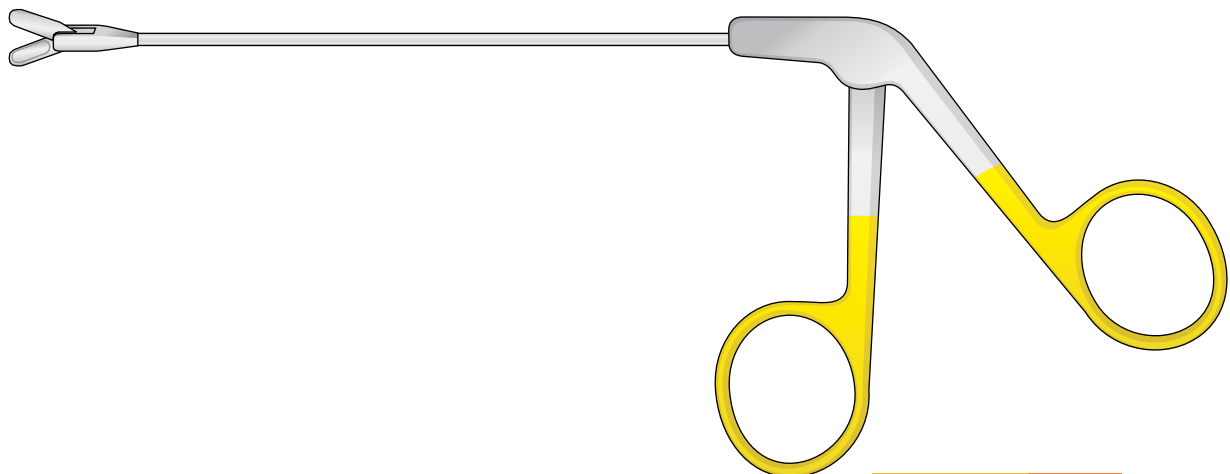

R 1850-14 14 cm

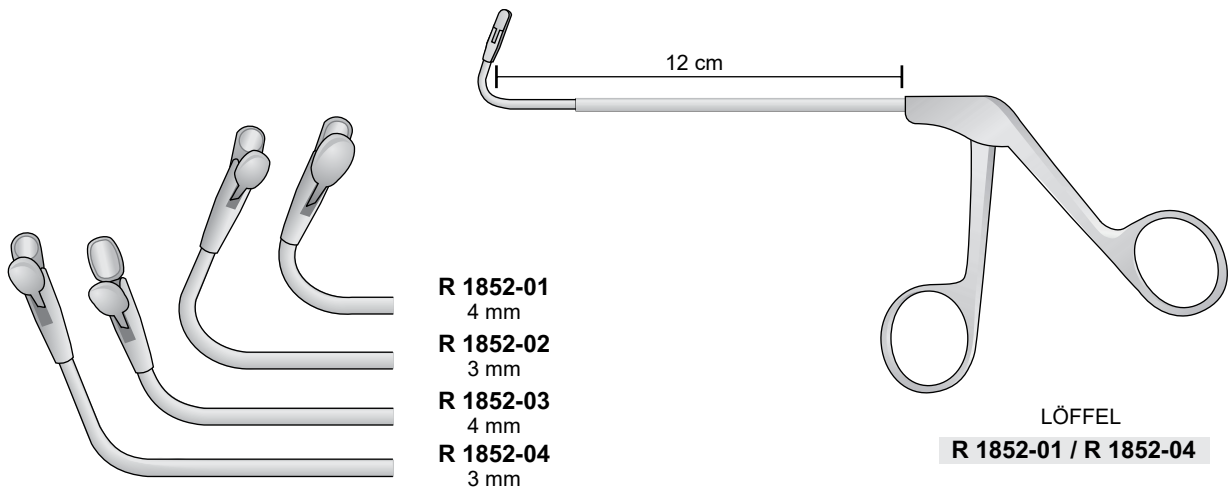
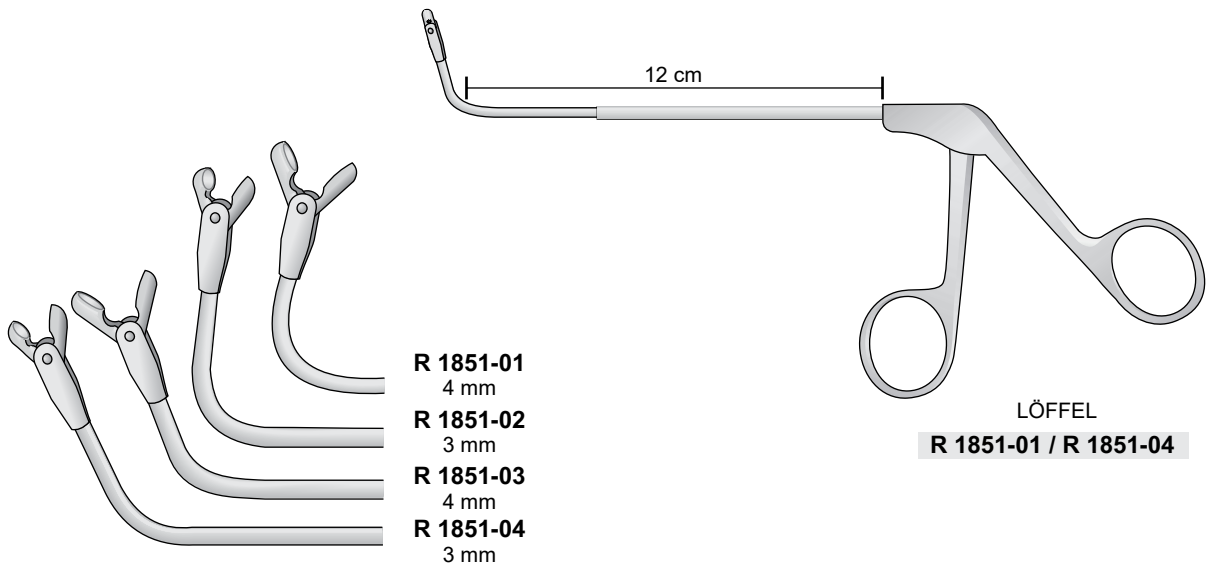

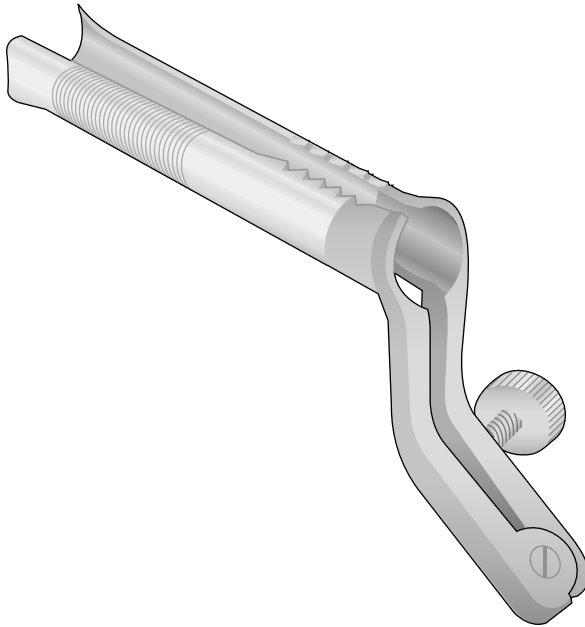

PAPAVERO-CASPAR
R 1853-01 80 x 11 mm
R 1853-02 90 x 13 mm
R 1853-03 100 x 15 mm

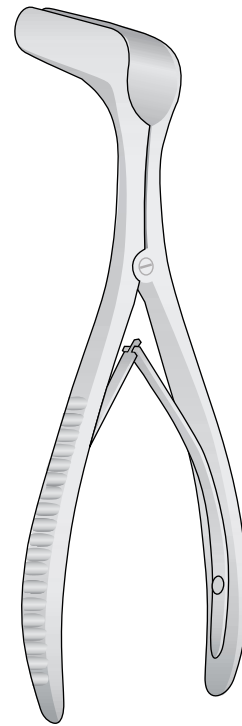

PAPAVERO-HARTMANN
R 1854-14 14 cm

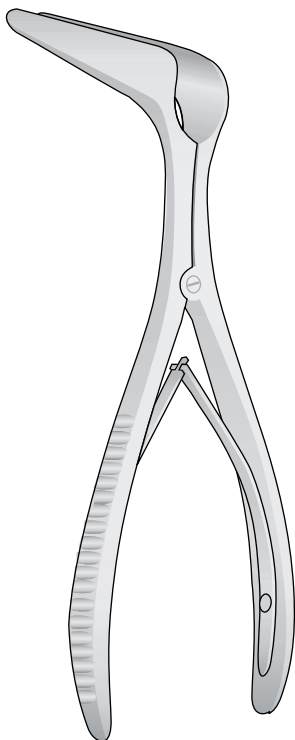

COTTLE
R 1855-01 / R 1855-04
 15 cm

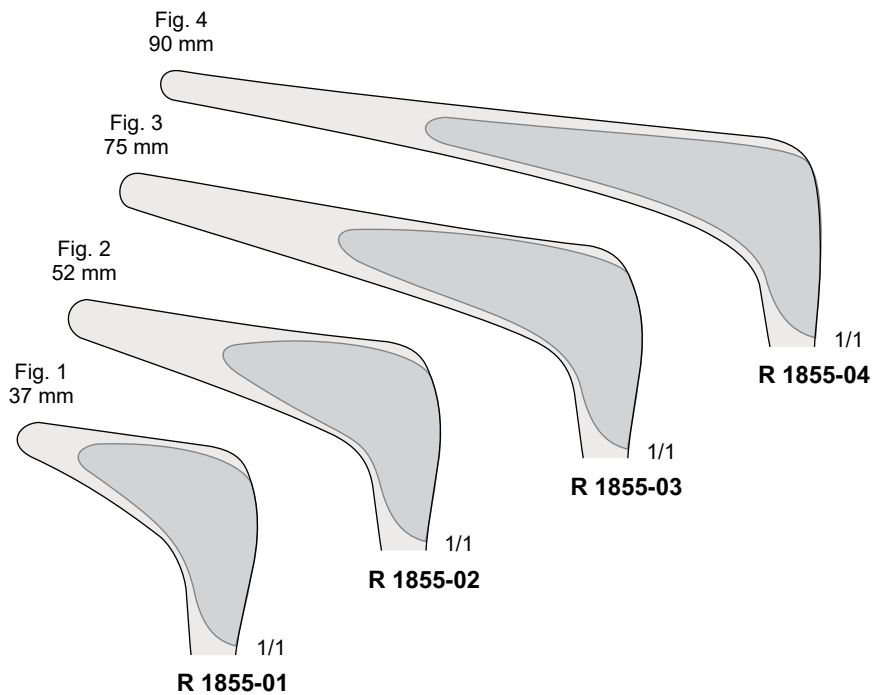

Speculum nasali
Nasal specula
Nasen Spekula
Spéculums nasaux
Espéculos nasales

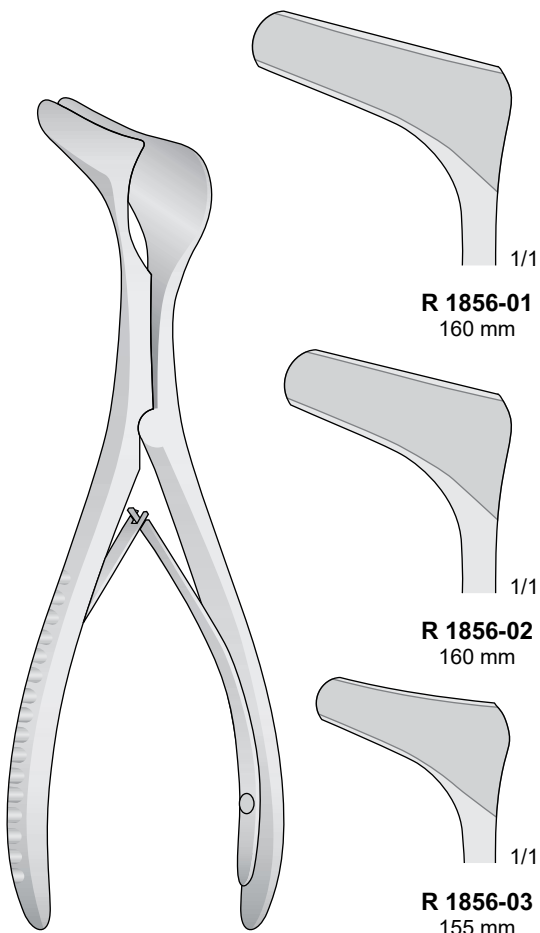

HARTMANN

R 1856-01 / R 1856-03

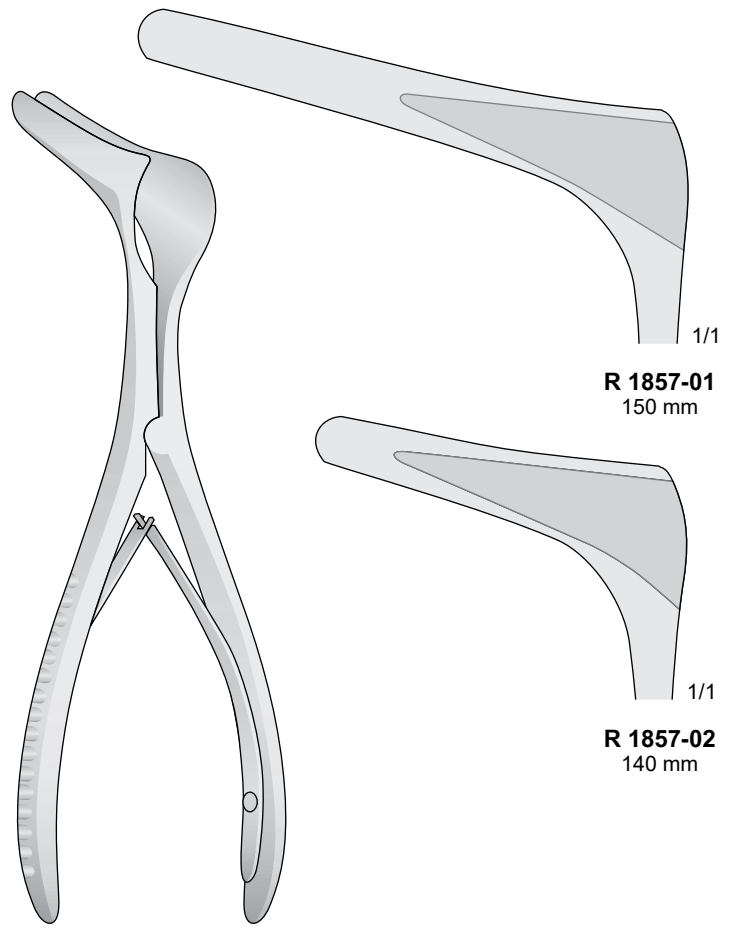

KILLIAN

R 1857-01 / R 1857-02

Speculum nasali
Nasal specula
Nasen Spekula
Spéculums nasaux
Espéculos nasales

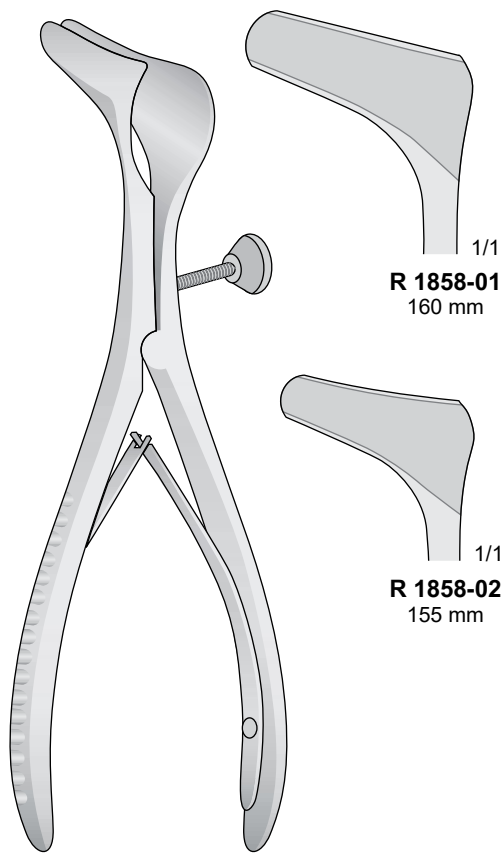

HARTMANN
R 1858-01 / R 1858-02

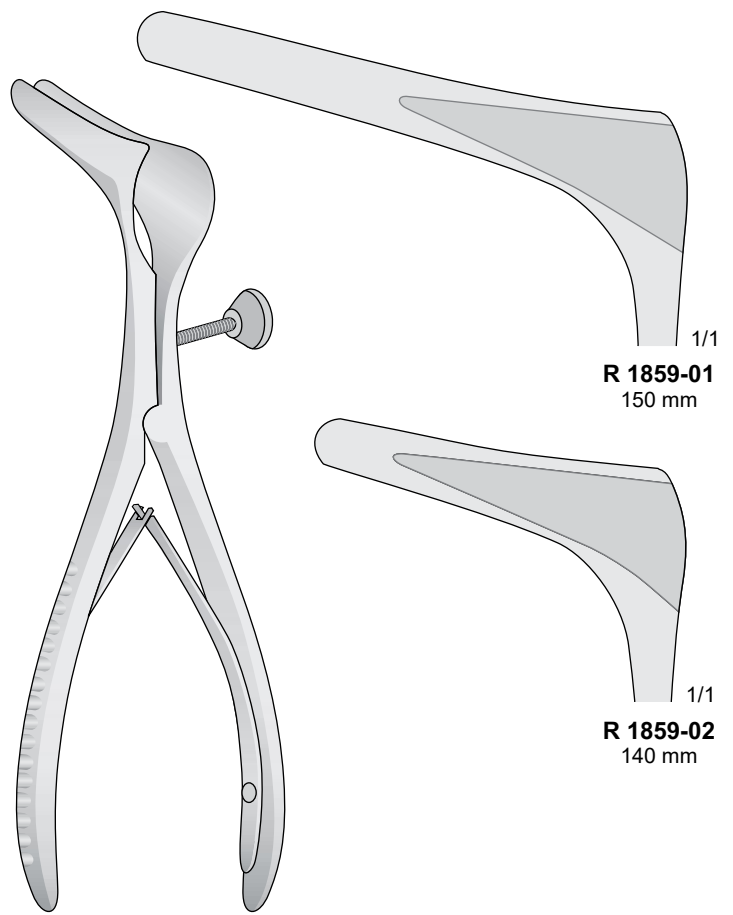

KILLIAN
R 1859-01 / R 1859-02

Pinza serranodi
Ear polypus snares
Polypenschnürer
Serre noeuds
Polipòtomos

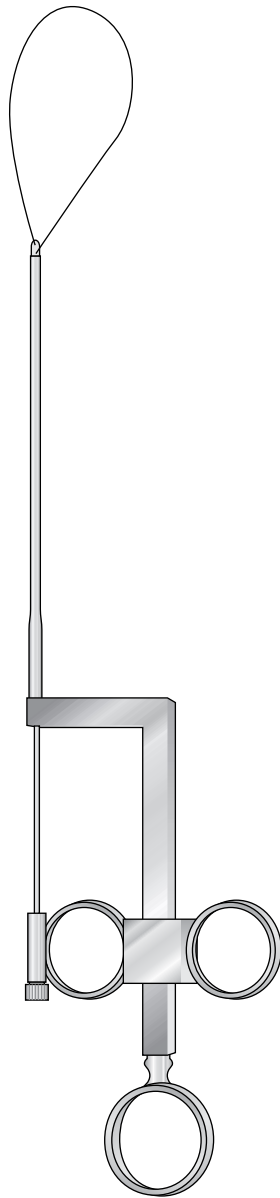

WILDE

R 1860-24 24 cm

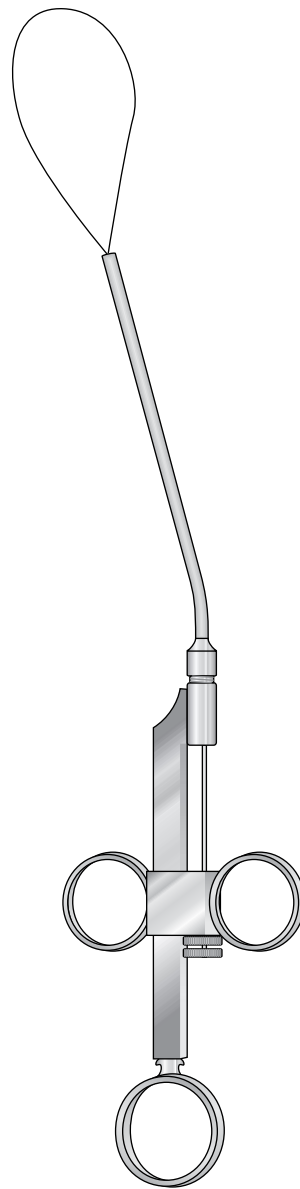

KRAUSE

R 1861-26 26 cm

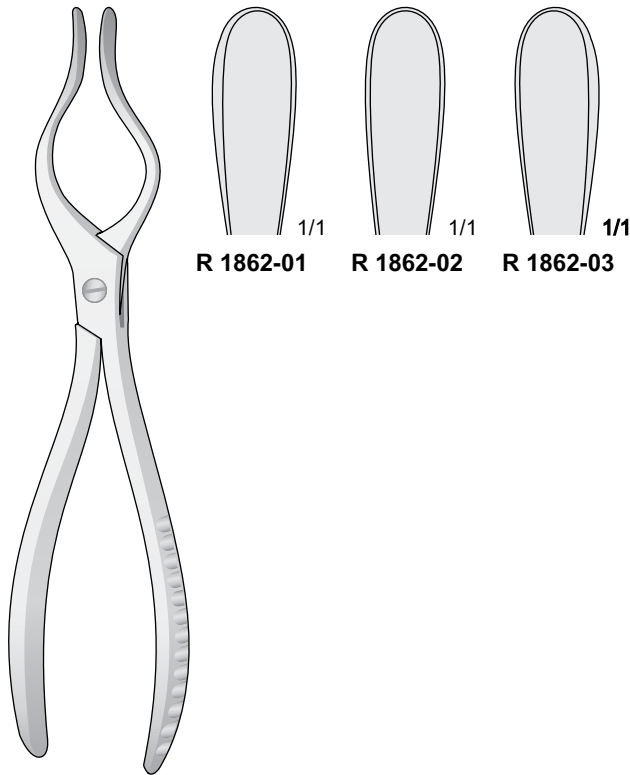

COTTLE-WALSHAM
R 1862-01 / R 1862-03
 23 cm

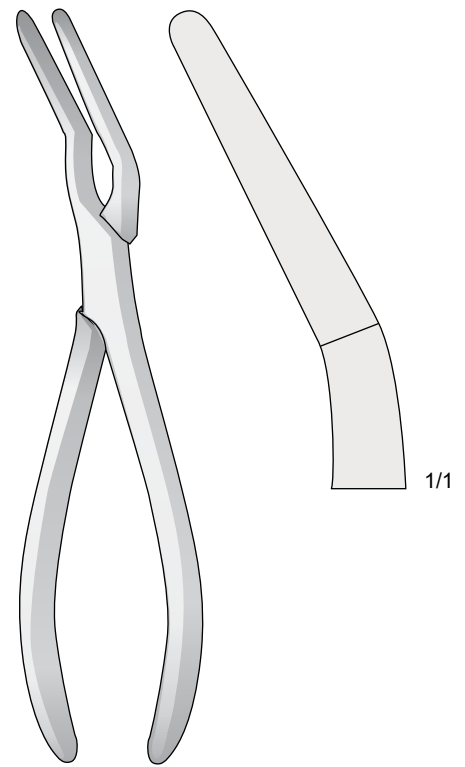

ASH
R 1863-23 23 cm

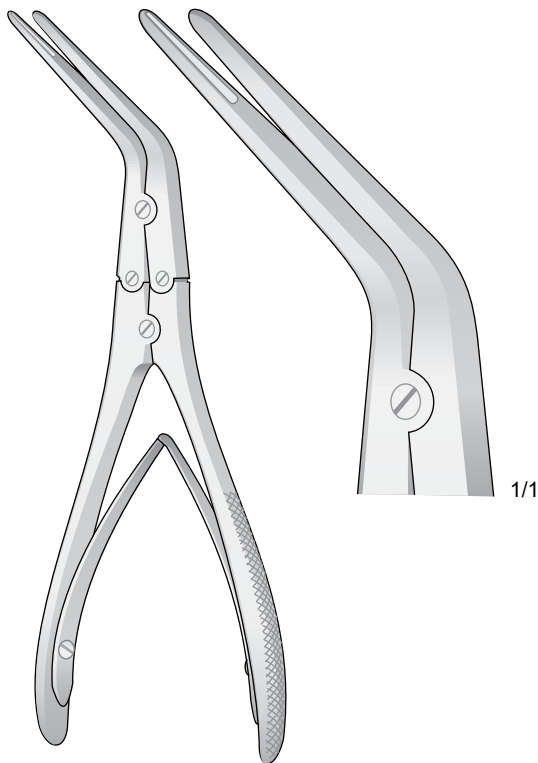

KRESSNER
R 1864-20 20 cm

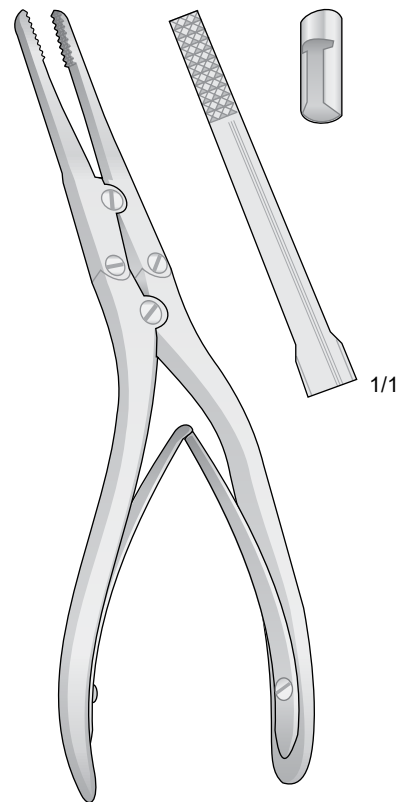

RUBIN
R 1865-21 21 cm

Strumento per rotture e asportazione frammenti ossei e cartilagine
Bone crusher
Knochen-Knorpelquetsche
Instrument à écraser le cartilage
Instrumento para magullar carilagos

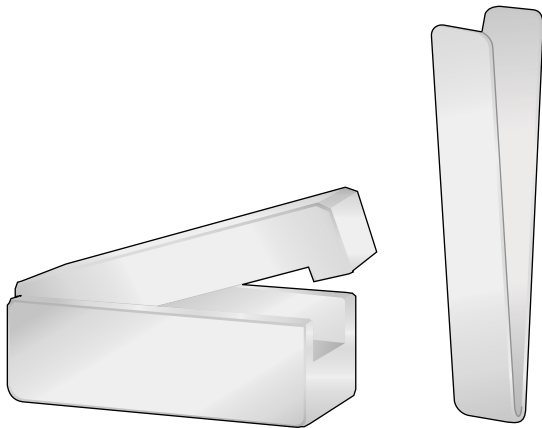

COTTLE
R 1866

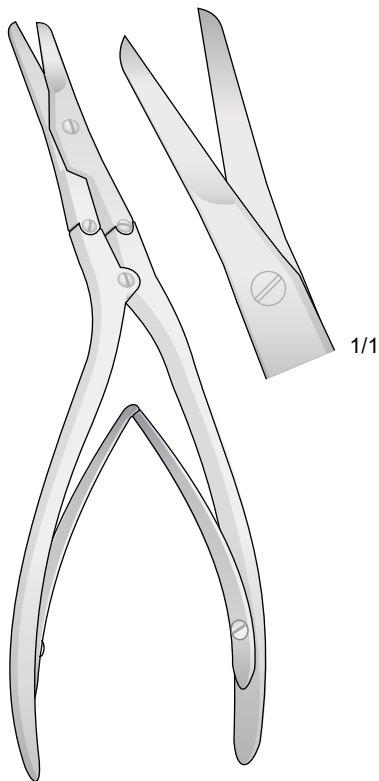

CAPLAN
R 1867-20 20 cm

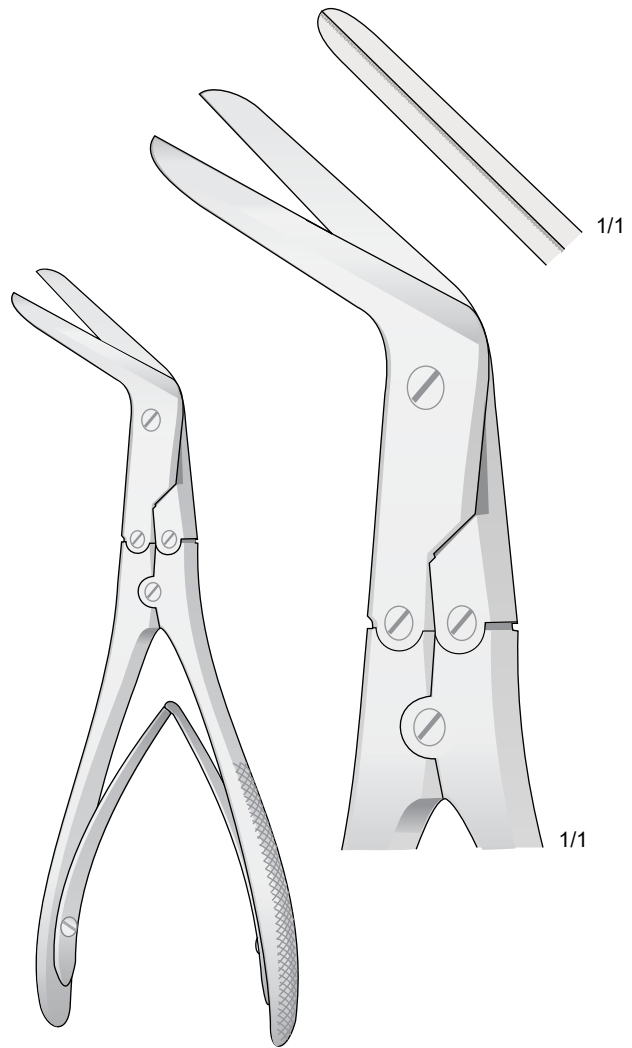

KILLIAN
R 1868-21 21 cm

Acuto/Smusso - Sharp/Blunt
 Spitz/Stumpf - Pointu/Mousse
 Agudas/Romas

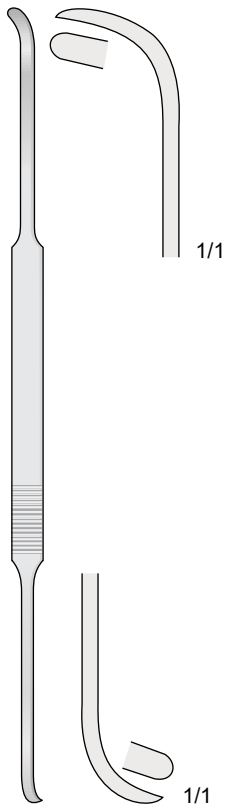

COTTLE

R 1869-23 23 cm

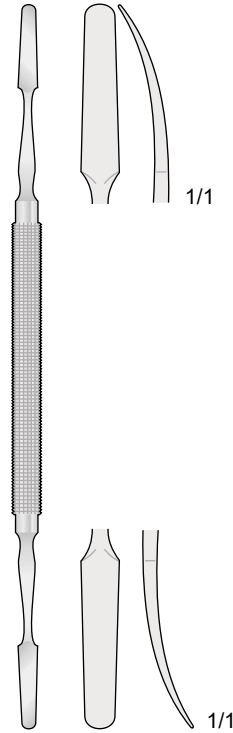

KILIAN

R 1870-18 18 cm

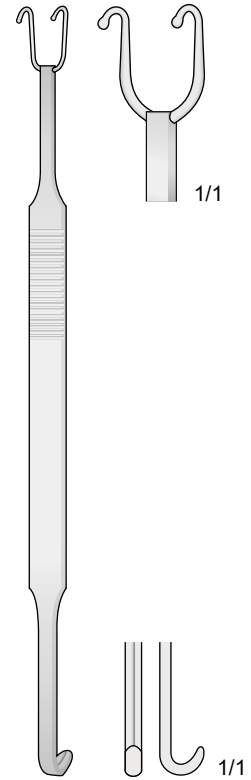

COTTLE-NEIVERT

R 1871-20 20 cm

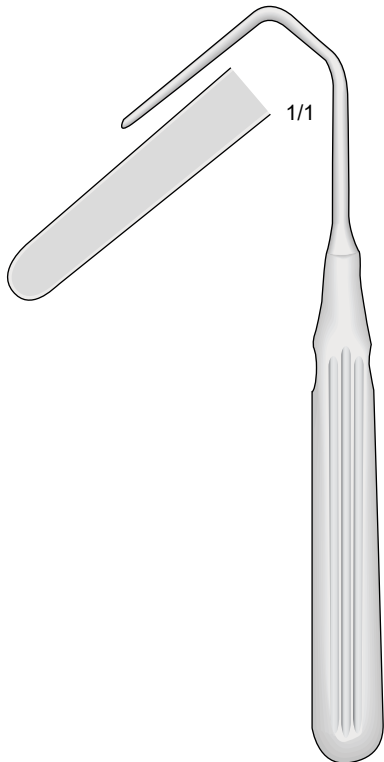

AUFRICHT

R 1872-17 17.5 cm

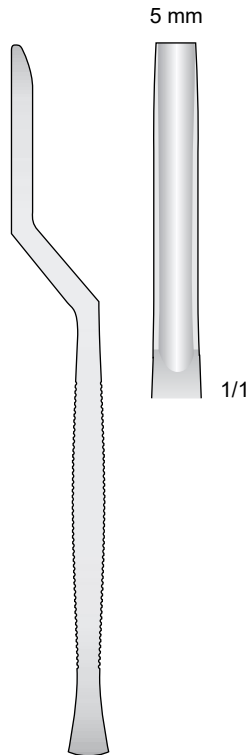

KILIAN

R 1873-16 16 cm

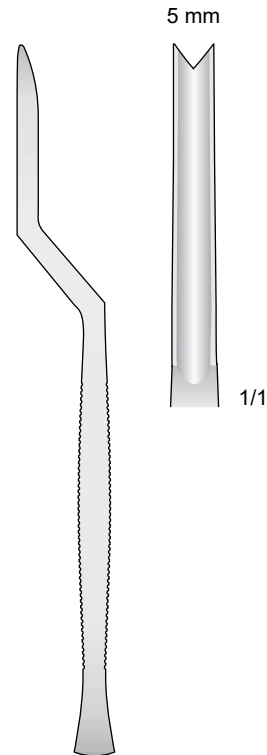

KILIAN-KLAUS

R 1874-16 16 cm

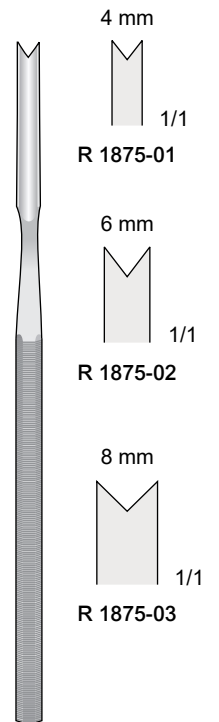

BALLENGER

R 1875-01 / R 1875-03

15 cm

Diritta
Straight
Gerade
Droites
Rectas

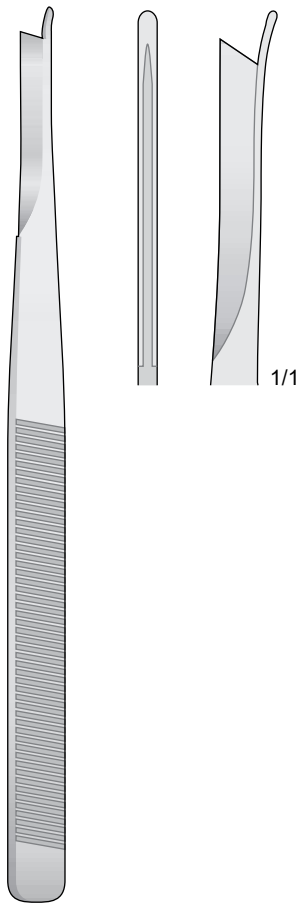

SILVER

R 1876-18 18 cm

Curva, sinistra
Curved, left
Gebogen, links
Courbes à gauche
Curvas a la izquierda

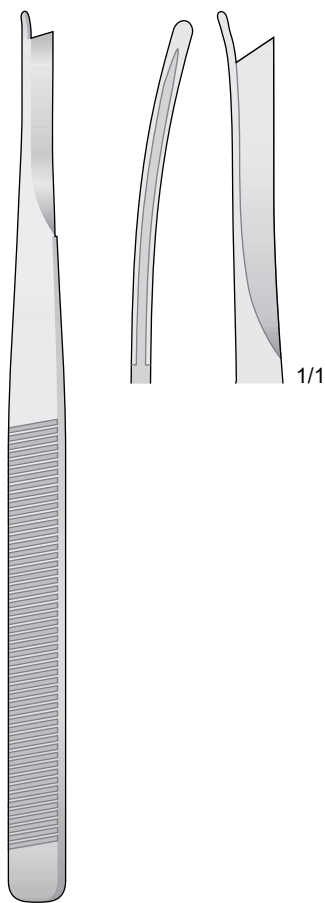

SILVER

R 1877-18 18 cm

Curva, destra
Curved, right
Gebogen, rechts
Courbes à droite
Curvas a la derecha

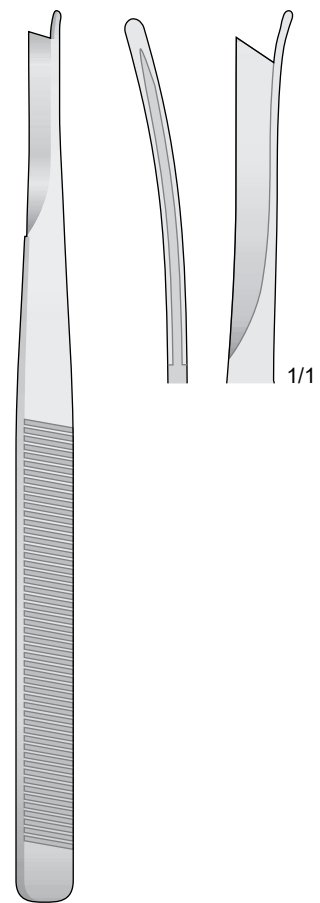

SILVER

R 1878-18 18 cm

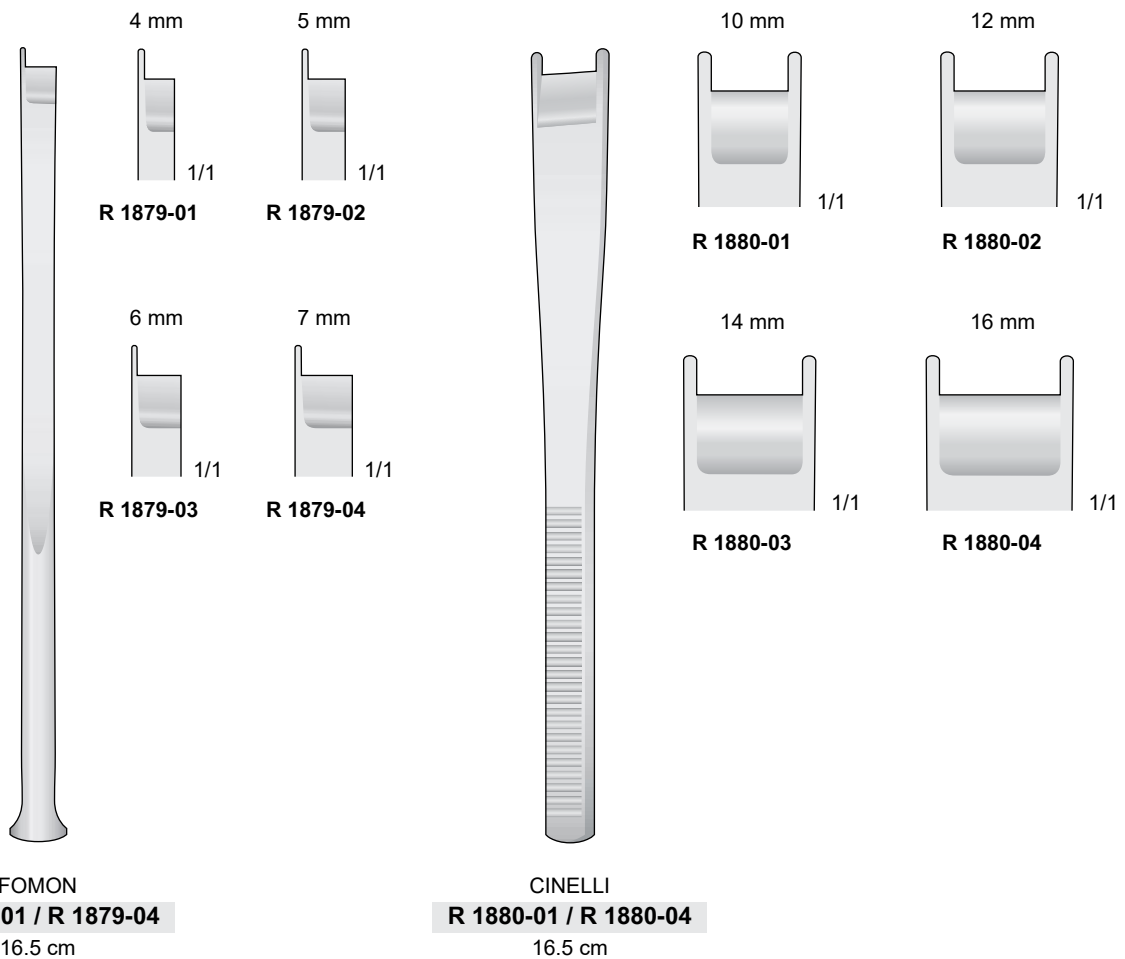

Nasal septum
Osteotomes, graduated

U form

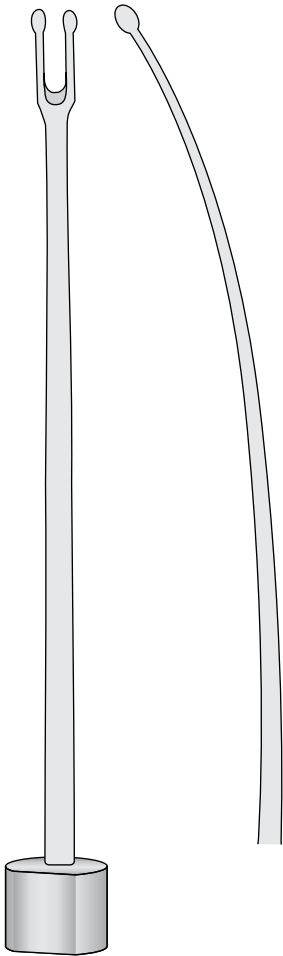

OBWEGESER
R 1881-18 18.5 cm

V form

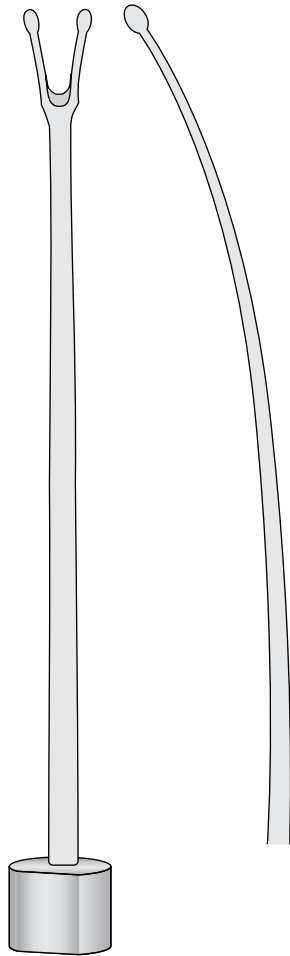

OBWEGESER
R 1882-18 18.5 cm

4 mm

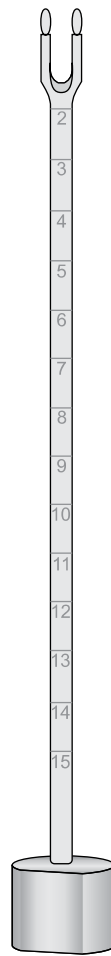

OBWEGESER
R 1883-18 18.5 cm

6 mm

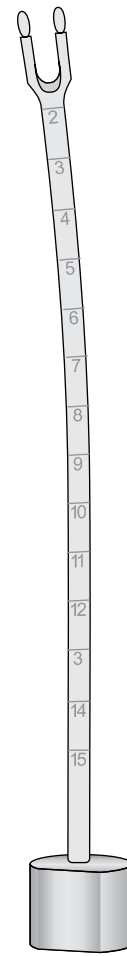

OBWEGESER
R 1884-18 18.5 cm

8 mm

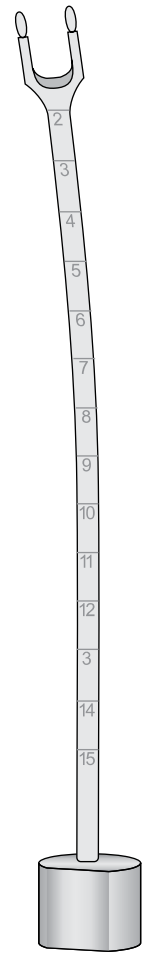

OBWEGESER
R 1885-18 18.5 cm

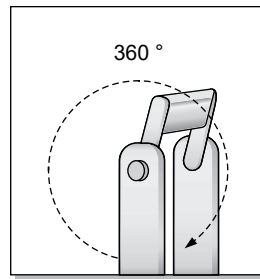

BALLENGER
R 1886-01 / R 1886-03
20 cm

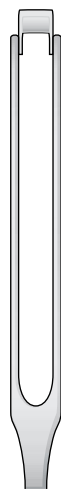

R 1886-01
3 mm



R 1886-02
4 mm



R 1886-03
5 mm

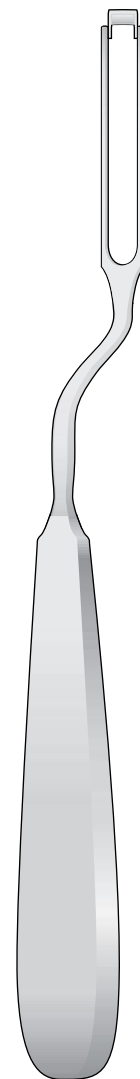

BALLENGER
R 1887-01 / R 1887-03
20 cm



R 1887-01
3 mm

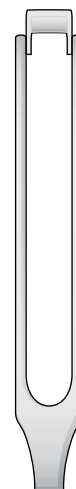

R 1887-02
4 mm

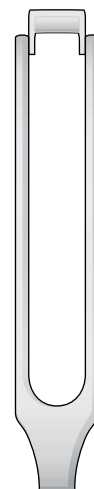

R 1887-03
5 mm

Fig. 67

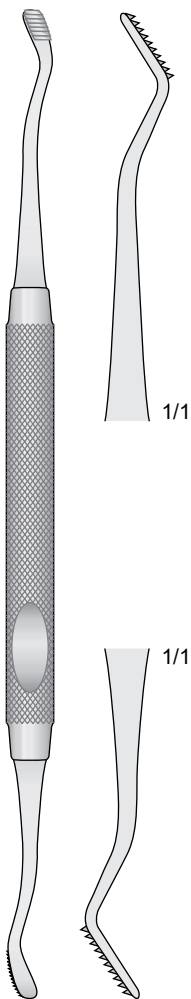

HOWARD

BF 1888-18 18 cm

Fig. 45

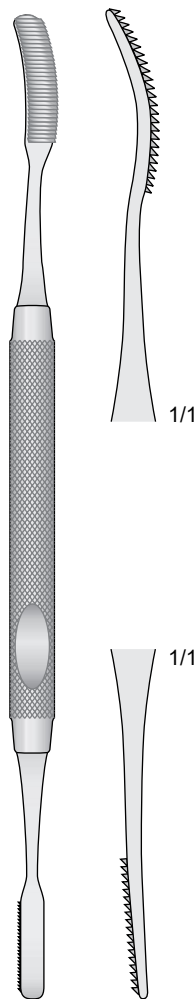

MILLER

BF 1889-18 18.5 cm

Fig. 52

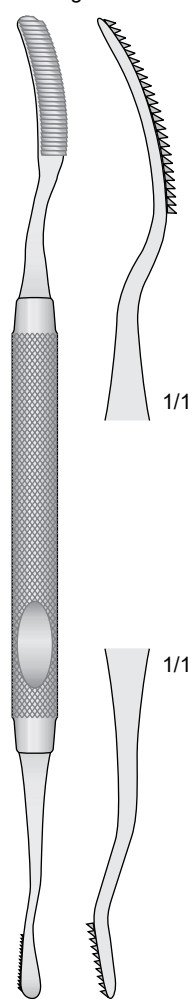

MILLER

BF 1890-18 18 cm

Lime per osso
Bone files
Knochenfeilen
Limes à os
Limas para huesos

8 mm



8 mm

BF 1891-21 21 cm

2 mm



5 mm

BF 1892-21 21 cm



1/1



1/1

8 mm



8 mm

BF 1893-21 21 cm

8 mm



8 mm

BF 1894-21 21 cm



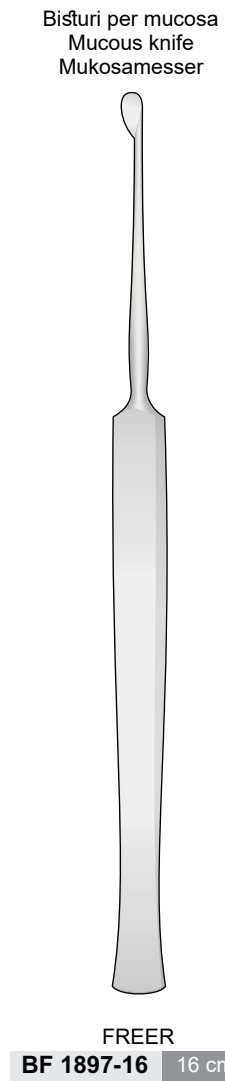
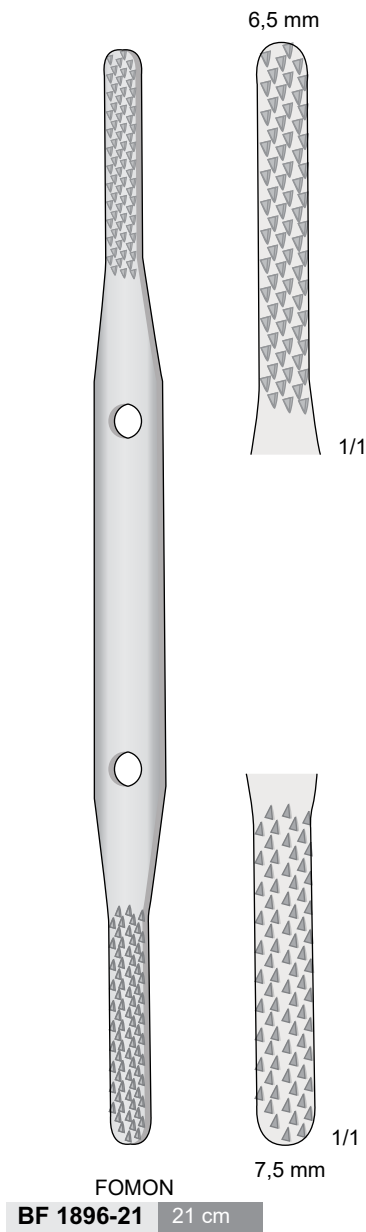
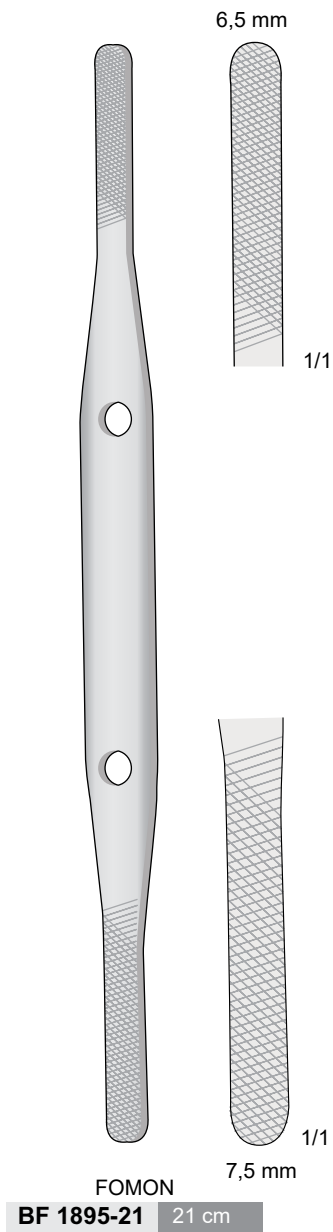

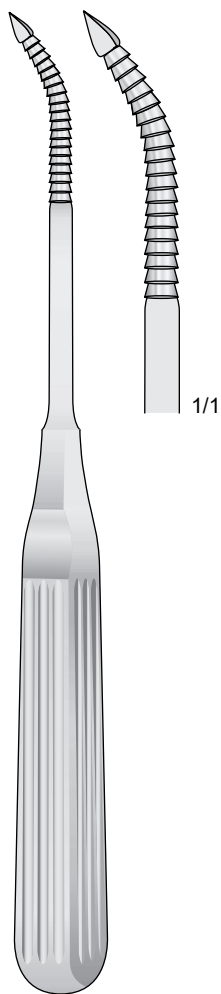

LEWIS

R 1898-18 18 cm

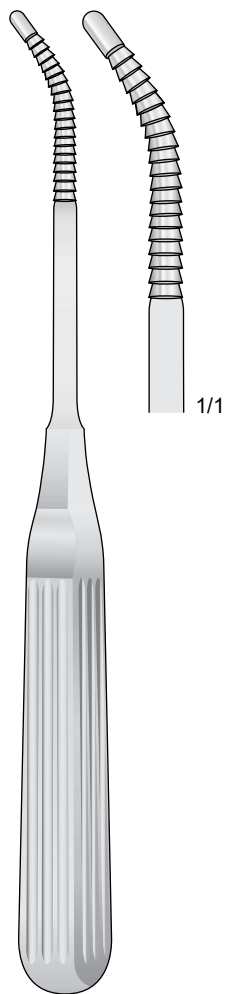

LEWIS

R 1899-18 18 cm



JOSEPH

R 1900-01 / R 1900-02
19 cm

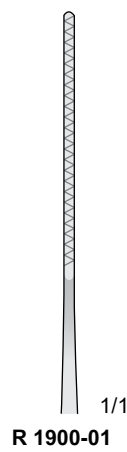

R 1900-01

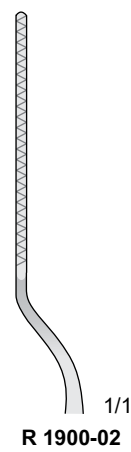

R 1900-02

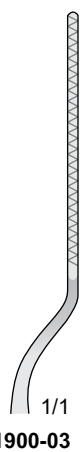

R 1900-03

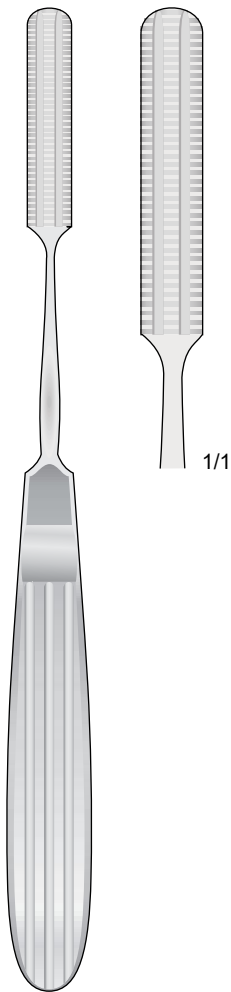

MALTZ

R 1901-18 18 cm

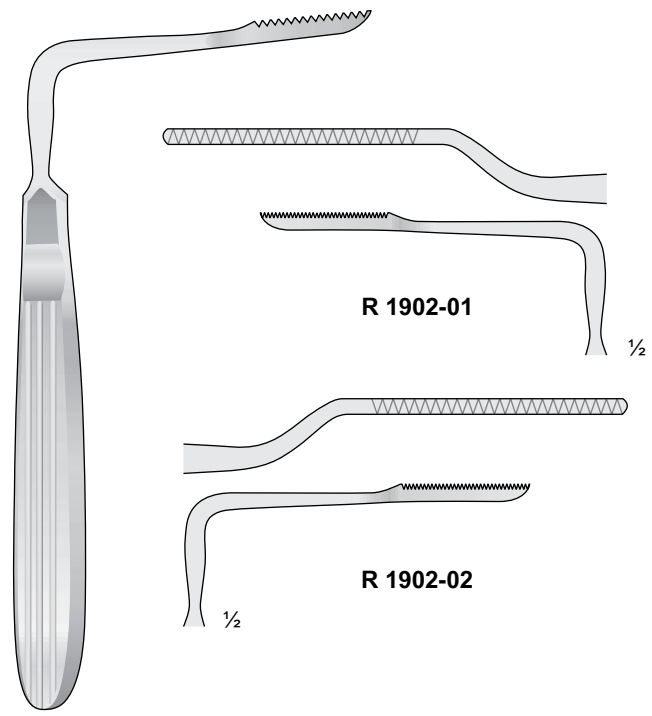

JOSEPH

R 1902-01 / R 1902-02
13.5 cm

Uncino per arco zigomato
 Zigoma hook
 Haken-Jochbogenahle

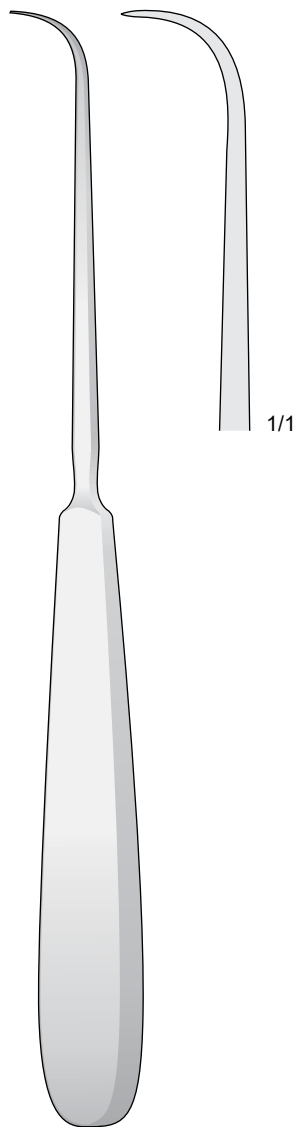

R 1903-20 20 cm

Curette taglienti
 Scharfe Küretten
 Currettes Tranchantes

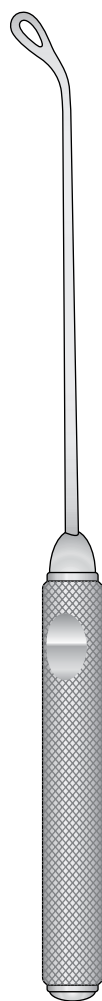

COAKLEY

R 1904-01 / R 1904-06

17 cm

Fig. 1



1/1

R 1904-01

Fig. 2



1/1

R 1904-02

Fig. 3



1/1

R 1904-03

Fig. 4



1/1

R 1904-04

Fig. 5



1/1

R 1904-05

Fig. 6



1/1

R 1904-06

Adenotomi - Adenotomie - Adenoidectomy
Adénoïdes - Adenoides

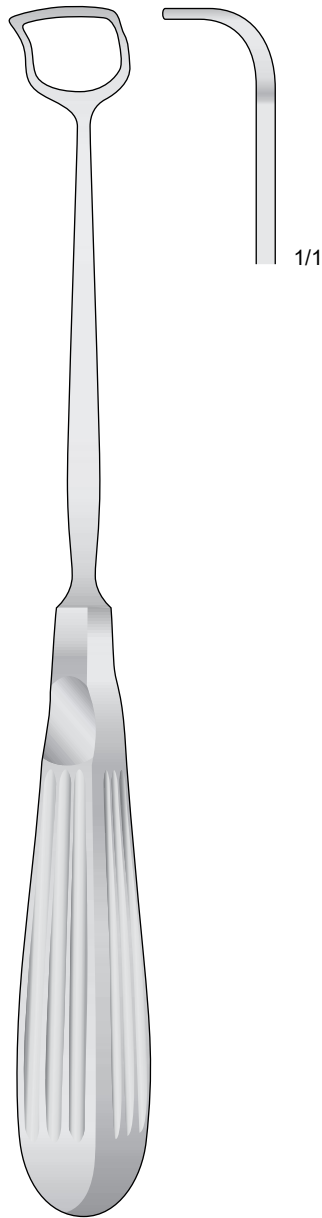

BECKMANN

R 1905-01 / R 1905-06

22 cm

Fig. 1

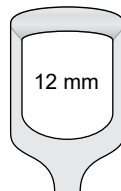

12 mm

R 1905-01

Fig. 2

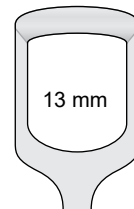

13 mm

R 1905-02

Fig. 3

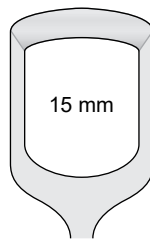

15 mm

R 1905-03

Fig. 4

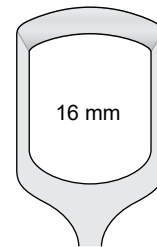

16 mm

R 1905-04

Fig. 5

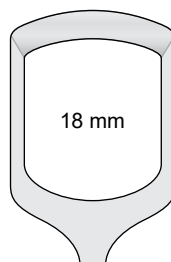

18 mm

R 1905-05

Fig. 6



19,5 mm

R 1905-06

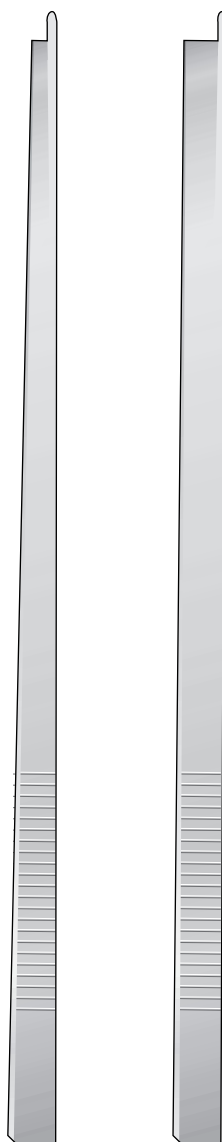

R 1906-20
20 cm

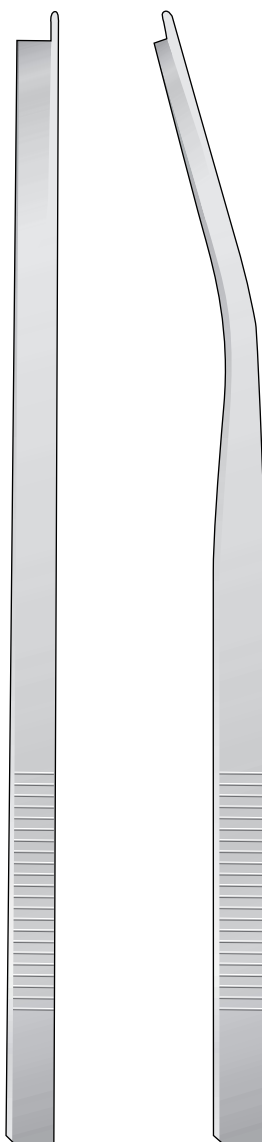

R 1907-20
20 cm

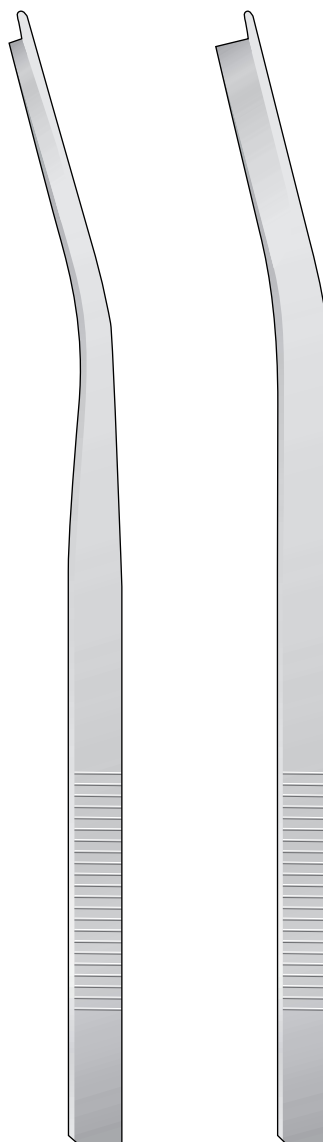

R 1908-20
20 cm

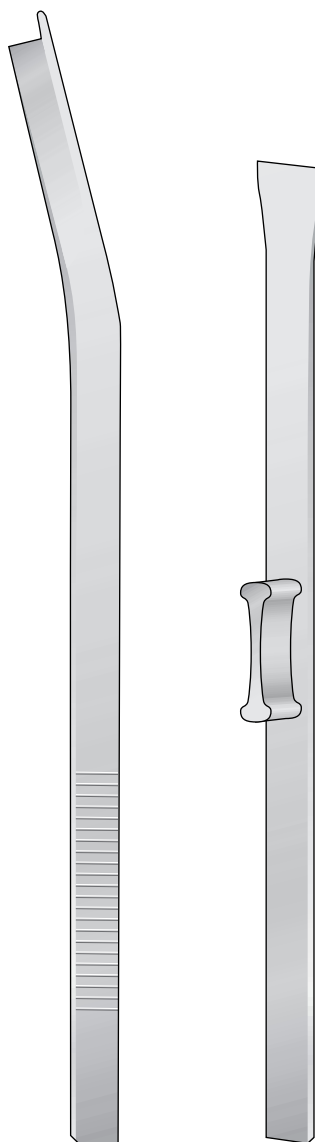

R 1909-20
20 cm

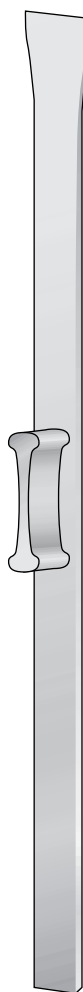

RUBIN
R 1910-01 / R 1910-03
18 cm

Osteotomi, Osteotomes
Osteotome, Ostéotomes, Osteótomos

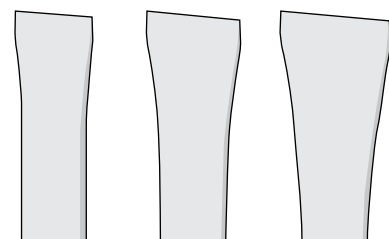

R 1910-01
10 mm

R 1910-02
12 mm

R 1910-03
14 mm

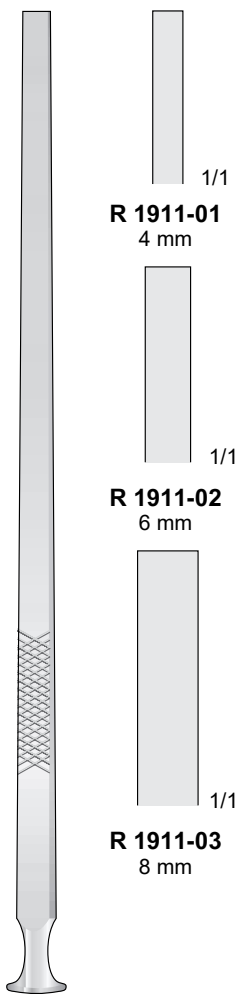

EPKER
R 1911-01 / R 1911-03
18 cm

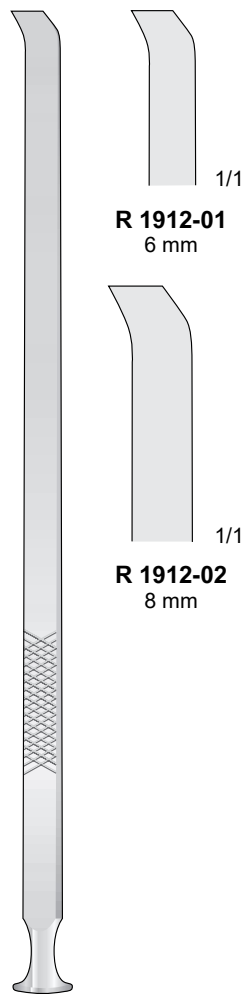

EPKER
R 1912-01 / R 1912-02
18 cm

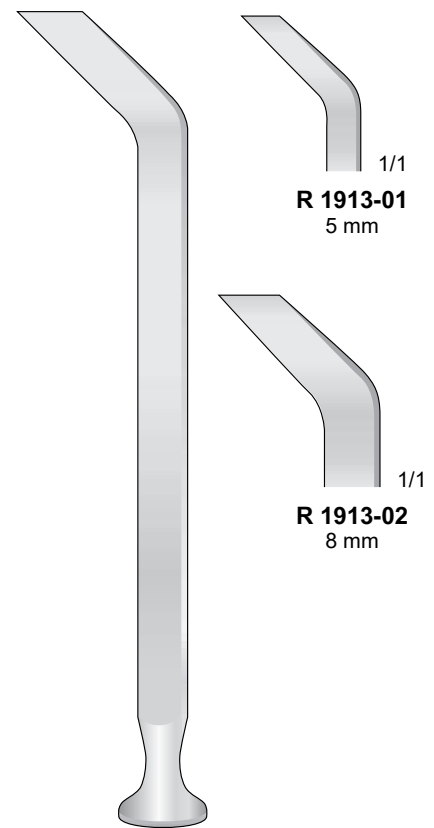

SPLIT
R 1913-01 / R 1913-02
15 cm

Osteotomi
Osteotomes
Osteotome
Ostéotomes
Osteòtomos

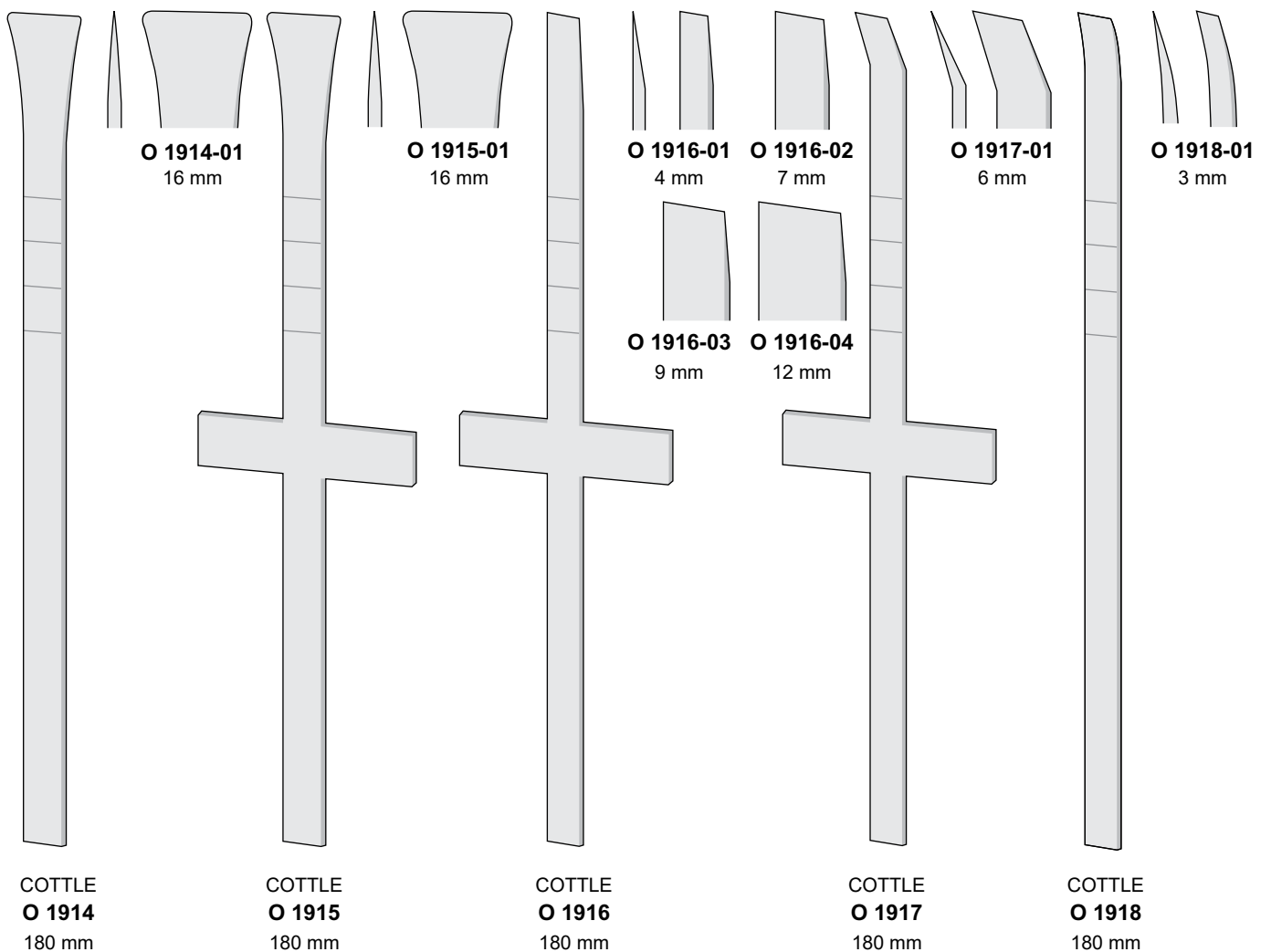

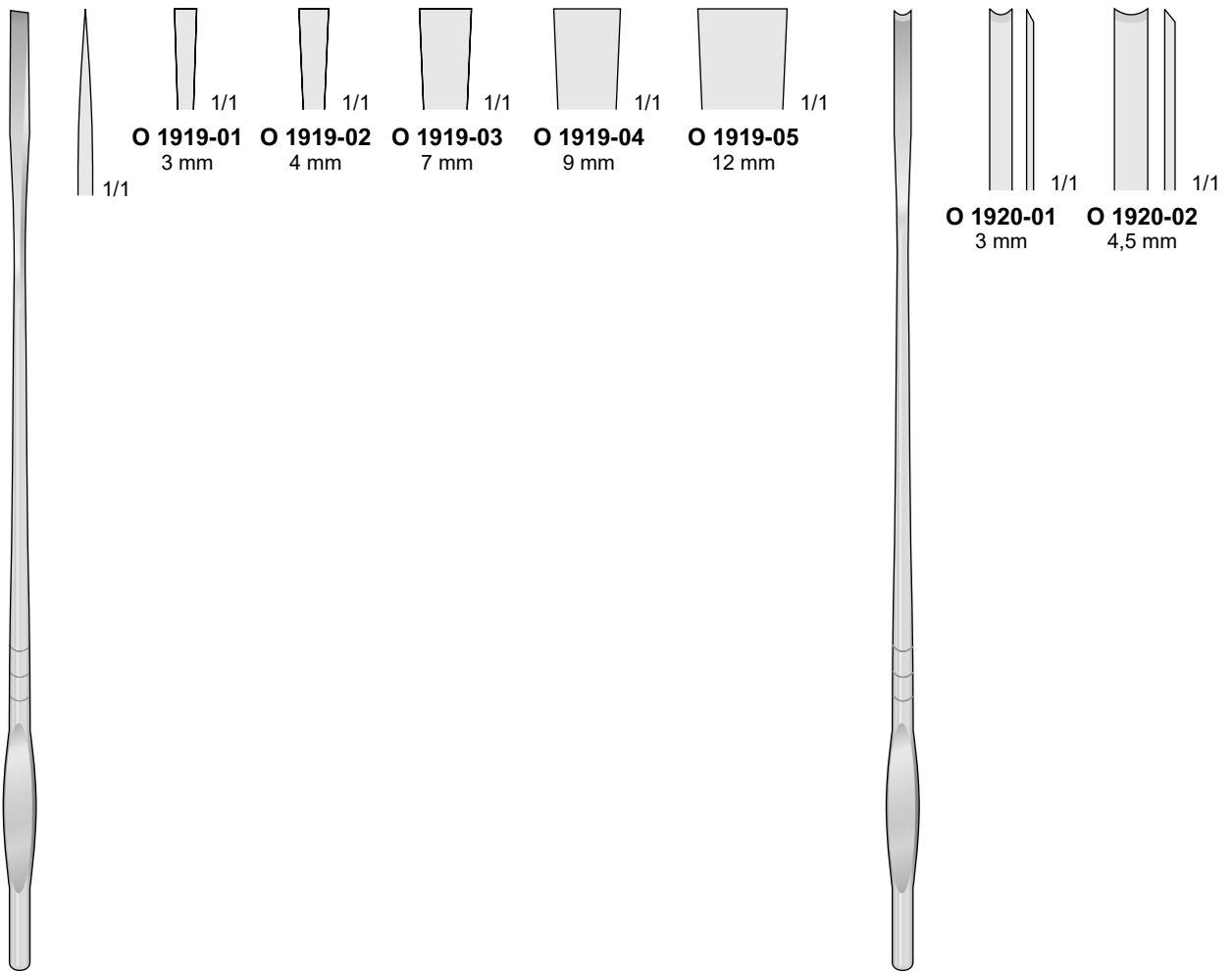

O 1919-01 / O 1919-05
19 cm

O 1920-01 / O 1920-02
19 cm

Osteotomi
Osteotomes
Osteotome
Ostéotomes
Osteòtomos

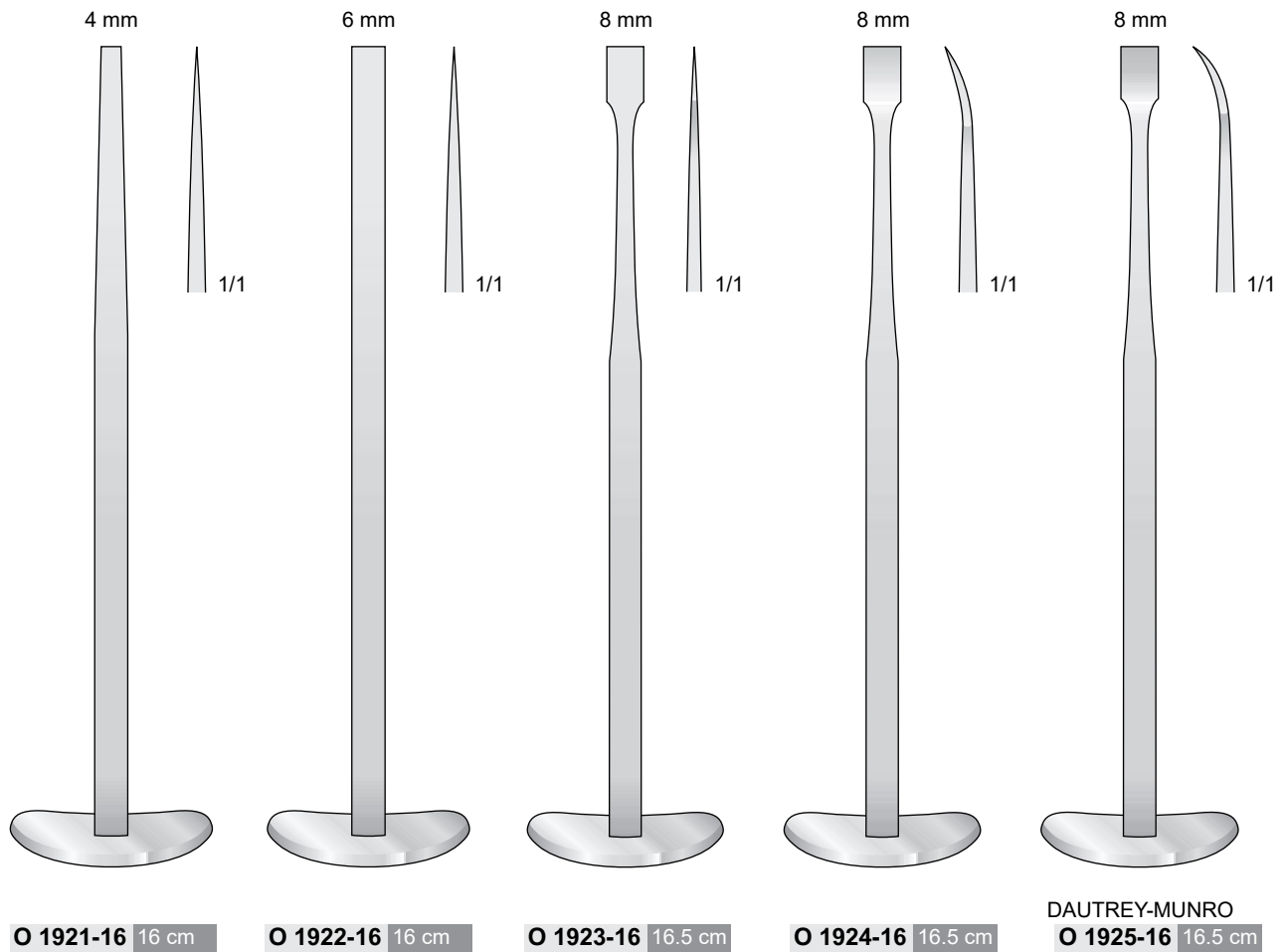

Osteotomi diritti graduati

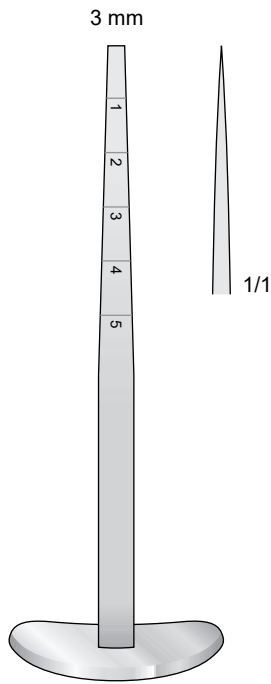

O 1926-11 11.5 cm

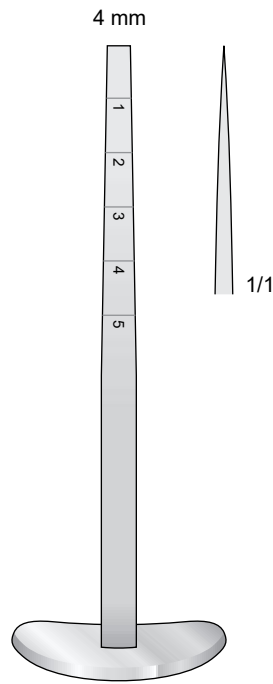

O 1927-11 11.5 cm

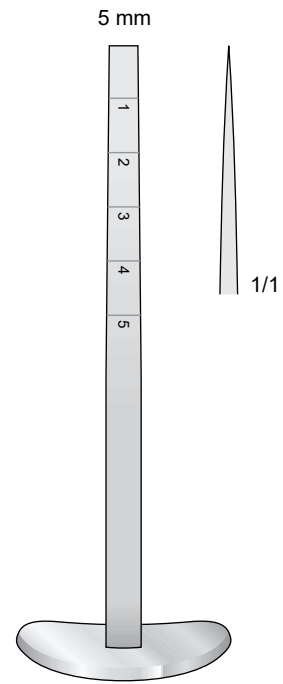

O 1928-11 11.5 cm

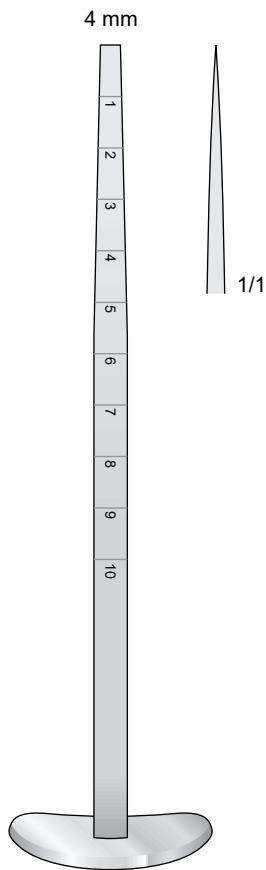

O 1929-16 16 cm

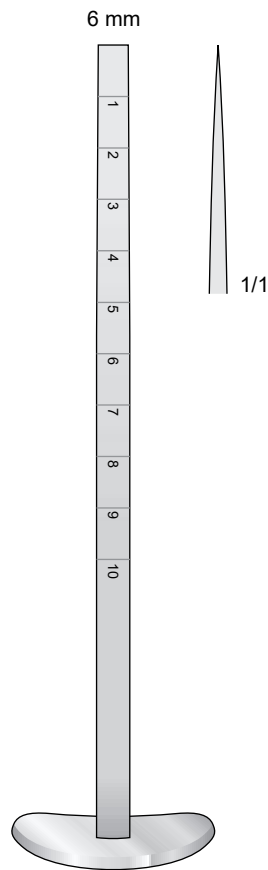

O 1930-16 16 cm

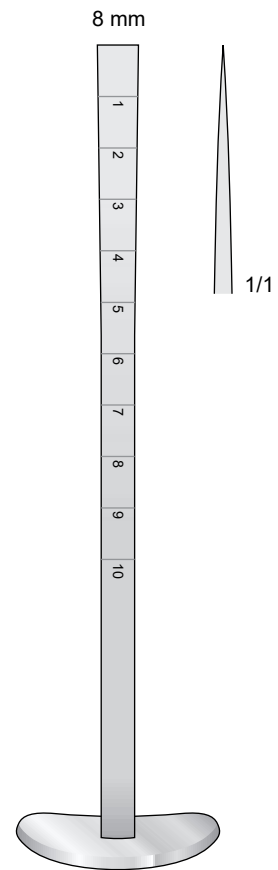

O 1931-16 16 cm

Osteotomi
 Osteotomes
 Osteotome
 Ostéotomes
 Osteõtomas

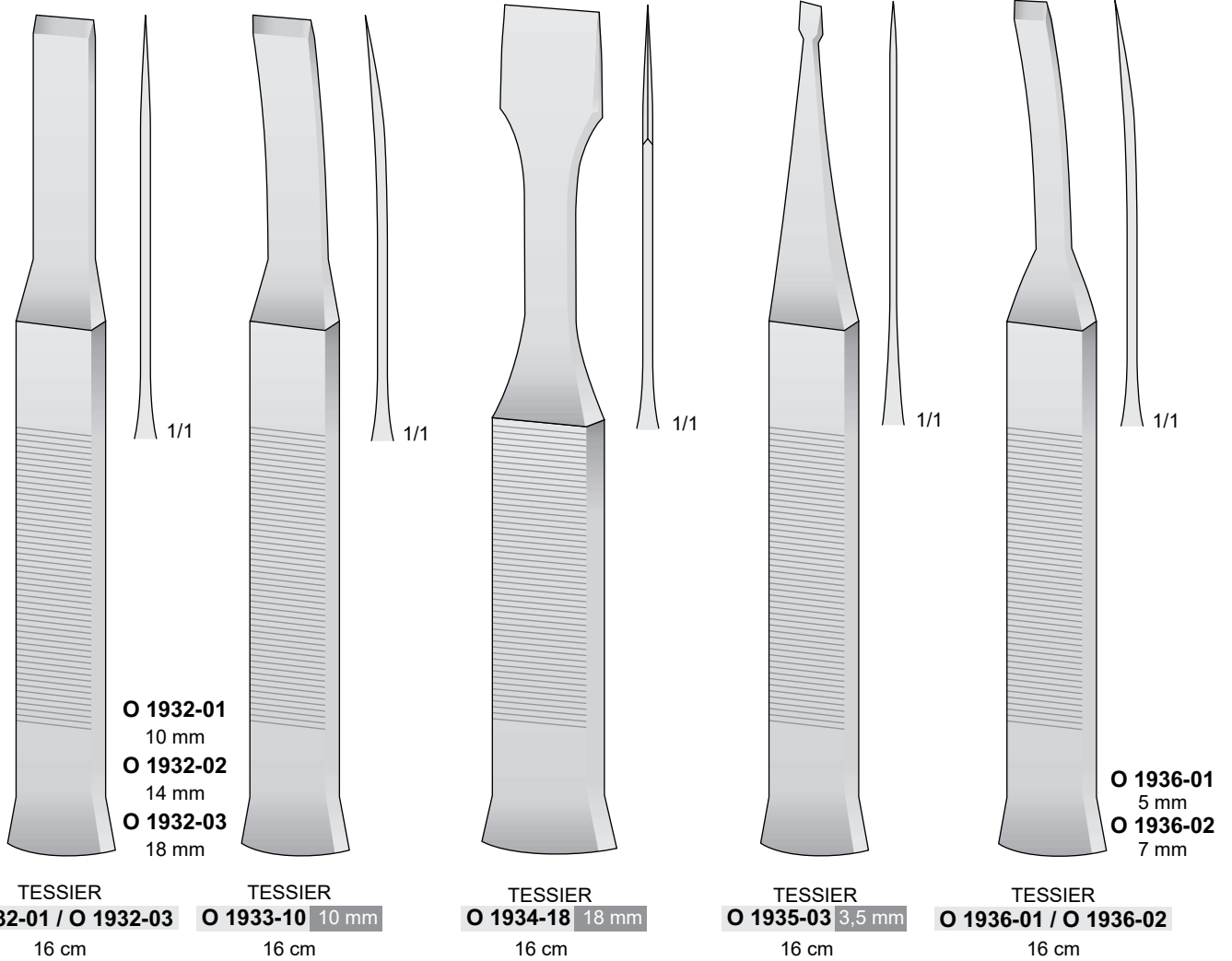

Osteotomi nasali
Nasal Osteotomes
Nasen Osteotome
Ostéotomes nasaux
Osteotomos nasales

Manico in ferrozell
With Ferrozell Handle
Mit Ferrozell-Griff
Avec poignée en Ferrozell
Con mango de Ferrozell

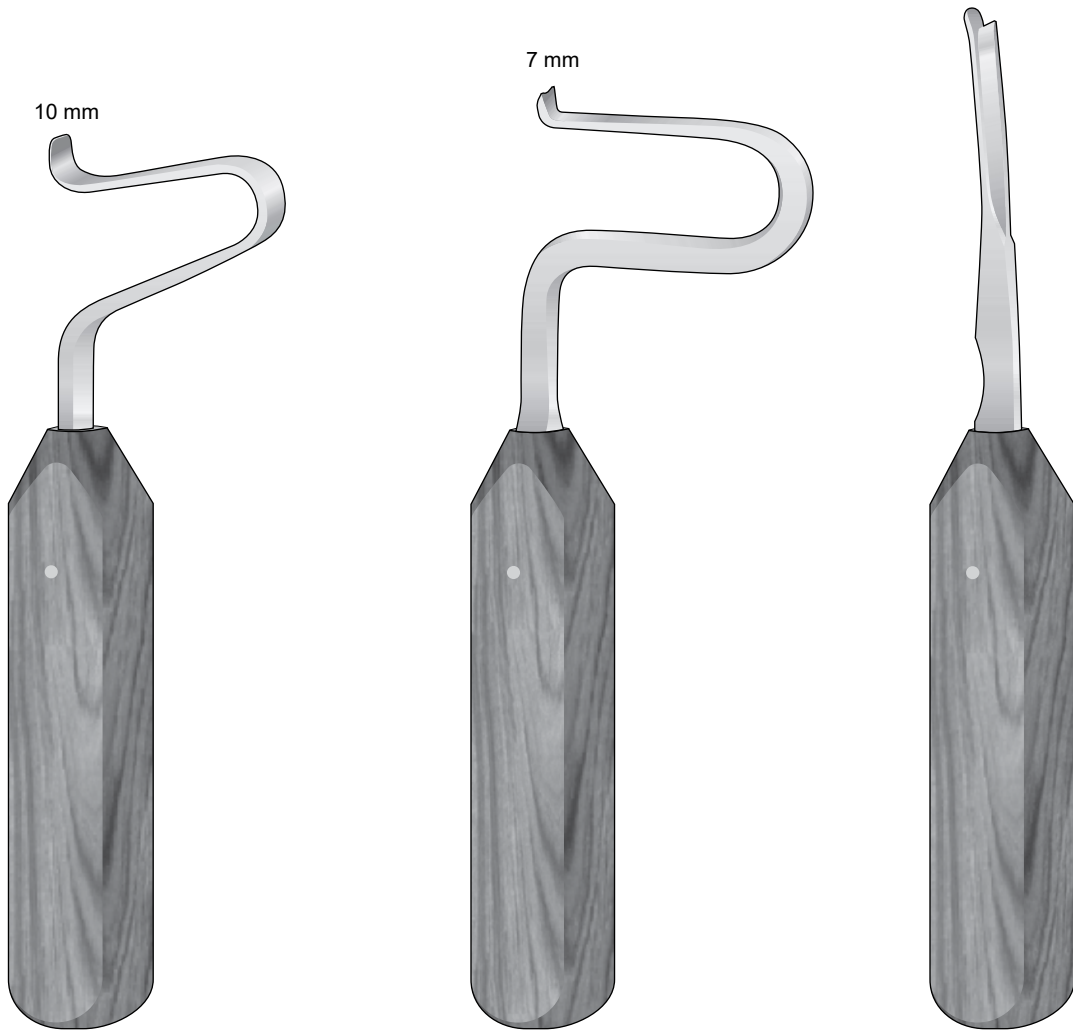

O 1937-17 17 cm

O 1938-19 19 cm

O 1939-01 20.5 cm destro - R
O 1939-02 20.5 cm sinistro - L

Chirurgia osse
Bone holding forcecp
Knochenchirurgi
Chirurgie Osseus
Pinzas para huesos

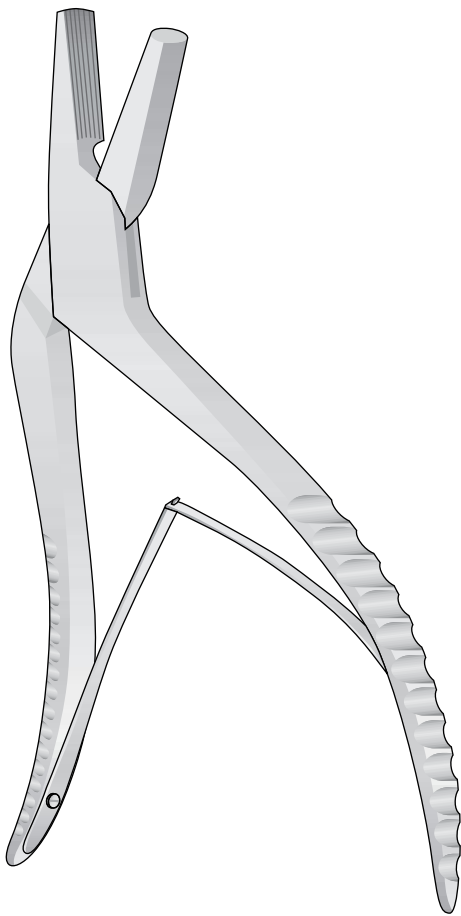

TESSIER
BHF 1940-19 19.5 cm

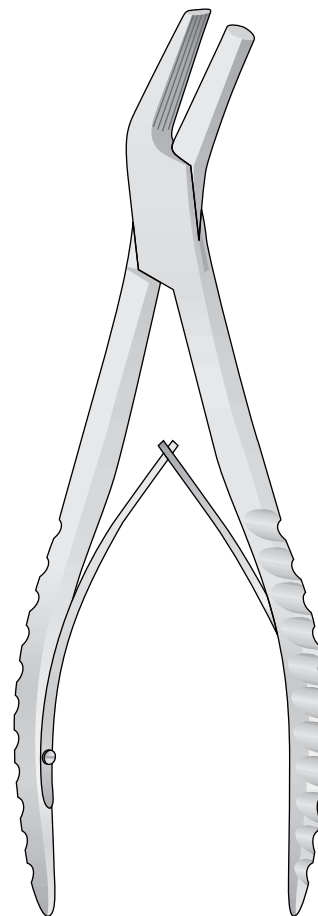

TESSIER
BHF 1941-22 22 cm

Bone cutters
Macina osso

BHF 1942-01 - Manico ad innesto cm. 19,5
Flexible handle
Abnehmbarer Griff

BHF 1942-02 - Vaschetta porta-osso con presa
Knochenbehälter
Container for bones

BHF 1942-03 - Tassello spingi-osso superiore
Oberer Knochen-drücker

BHF 1942-04 - Grattugia per CIPS fine #1
Reibe für GIPS, fein

BHF 1942-05 - Grattugia per CIPS grossi #2
Reibe für GIPS, grob

BHF 1942
Comprende una
sola grattugia

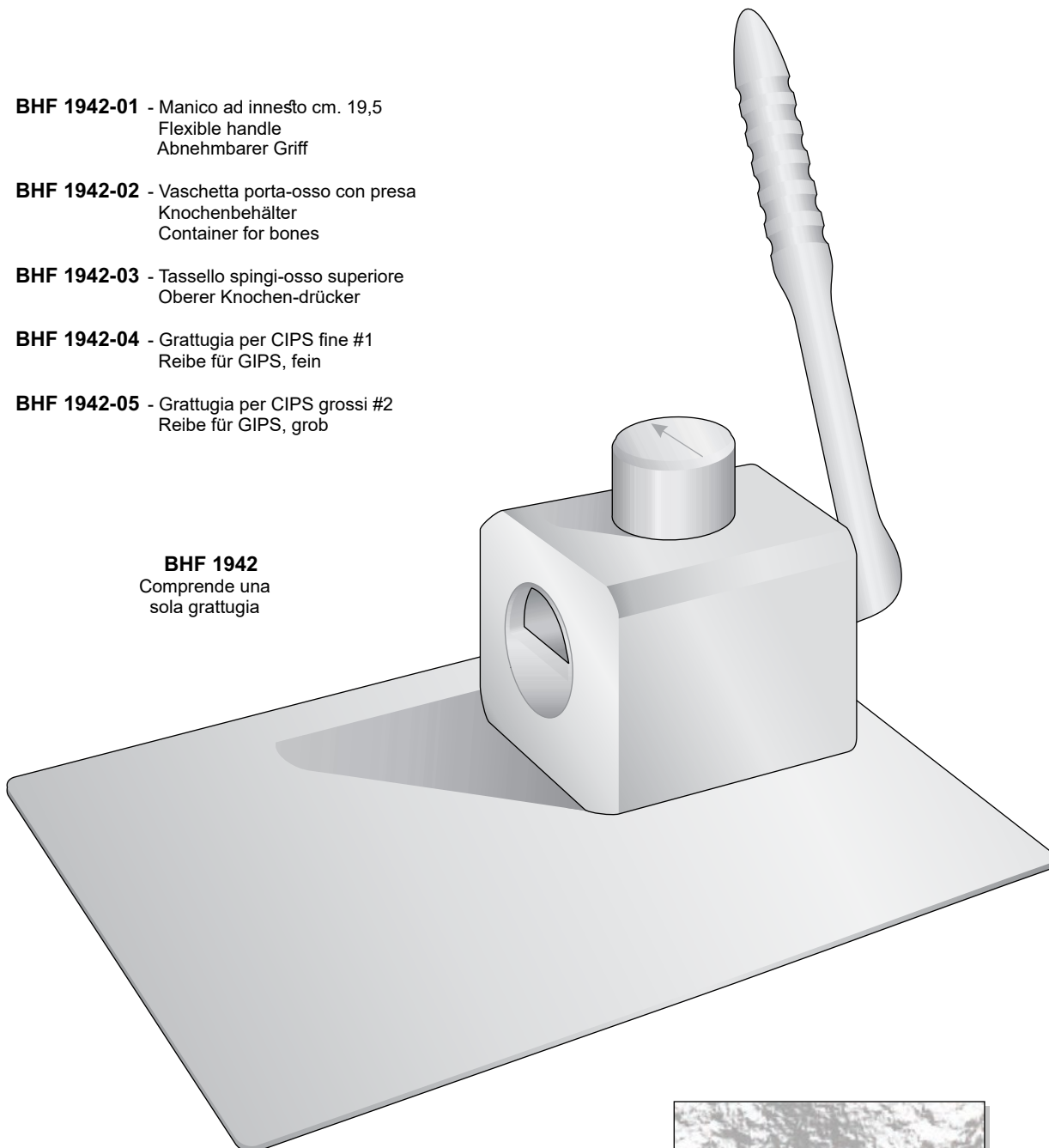

GABON
BHF 1943
235 x 160 x 100 mm
Kg 4,5

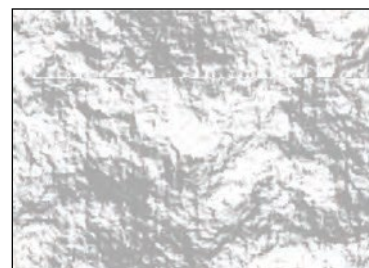

Cips macinato



we take a closer look

Ophthalmology



Ophthalmologie
Ophtalmologie
Oftalmología
Oftalmologia

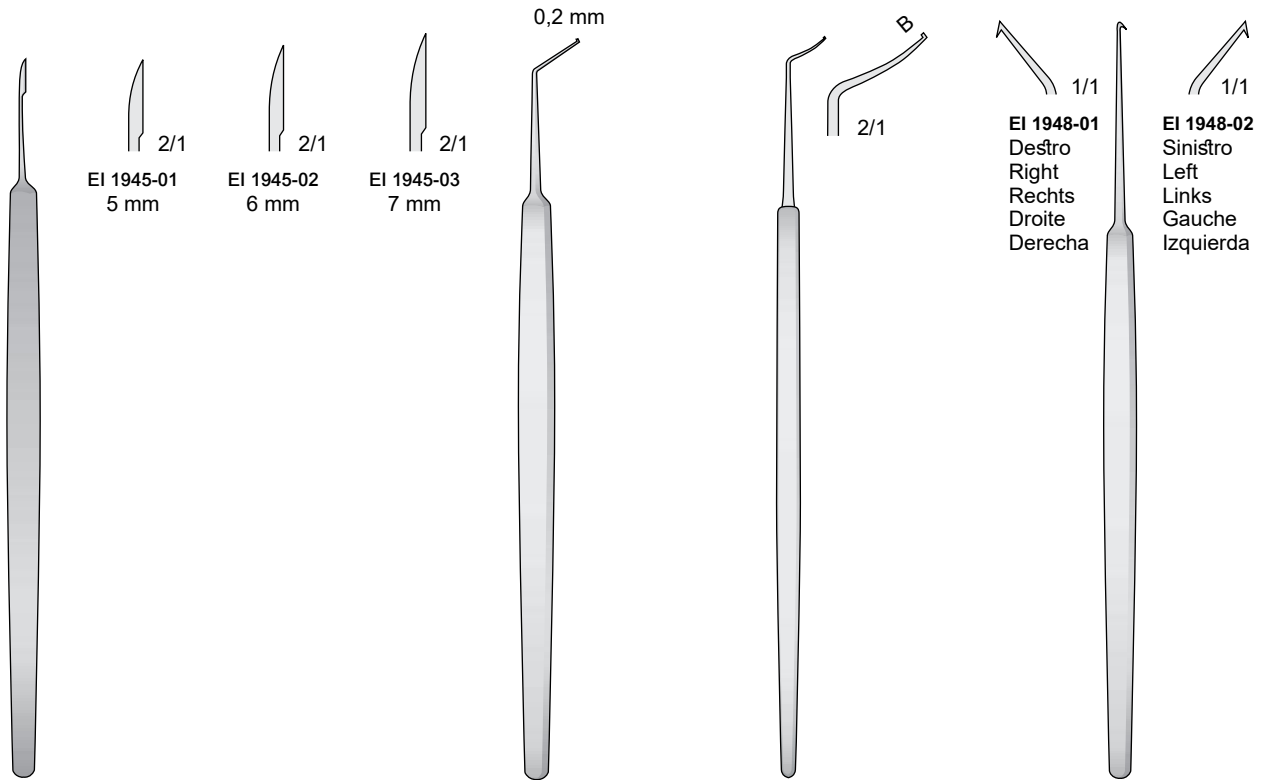

ZIEGLER

EI 1945-01 / EI 1945-03
11.5 cm

EI 1946-12 12 cm

B 125 mm

EI 1947-01 0,2 mm
EI 1947-02 0,3 mm

GRAEFE

EI 1948-01 / EI 1948-02
13 cm

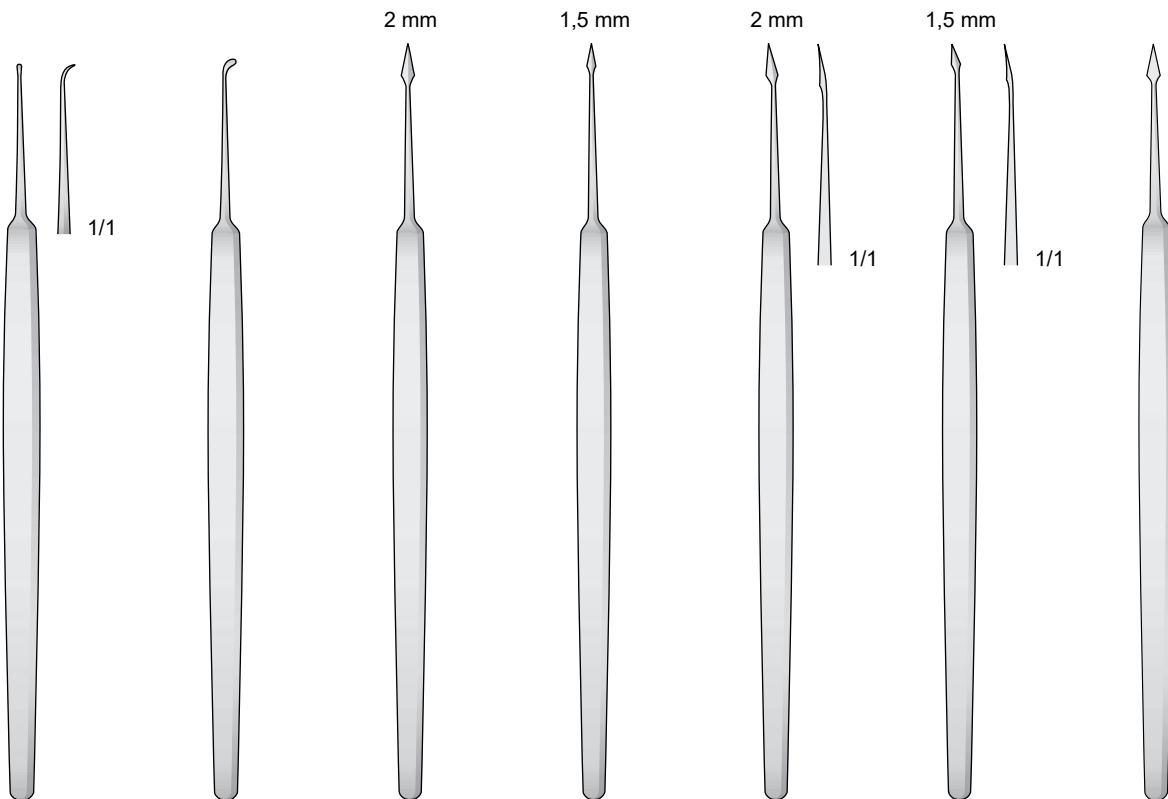

LA FORCE
EI 1949-12
12 cm

ELLIS
EI 1950-12
12 cm

EI 1951-12
12.5 cm

EI 1952-12
12.5 cm

EI 1953-12
12.5 cm

EI 1954-12
12.5 cm

EI 1955-12
12.5 cm

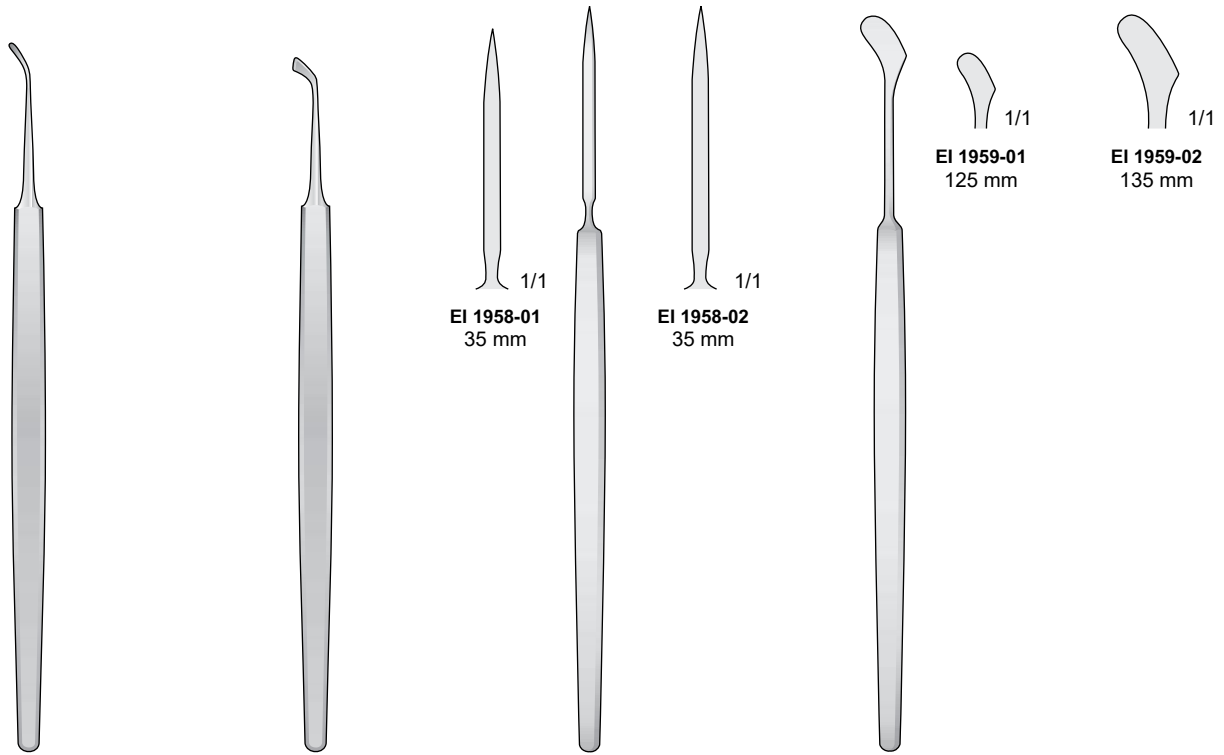

EI 1958-01
35 mm

EI 1958-02
35 mm

EI 1959-01
125 mm

EI 1959-02
135 mm

EI 1956-12 12.5 cm

EI 1957-12 12 cm

GRAEFE
 EI 1958-01 / EI 1958-02
 14 cm

GRAEFE
 EI 1959-01 / EI 1959-02

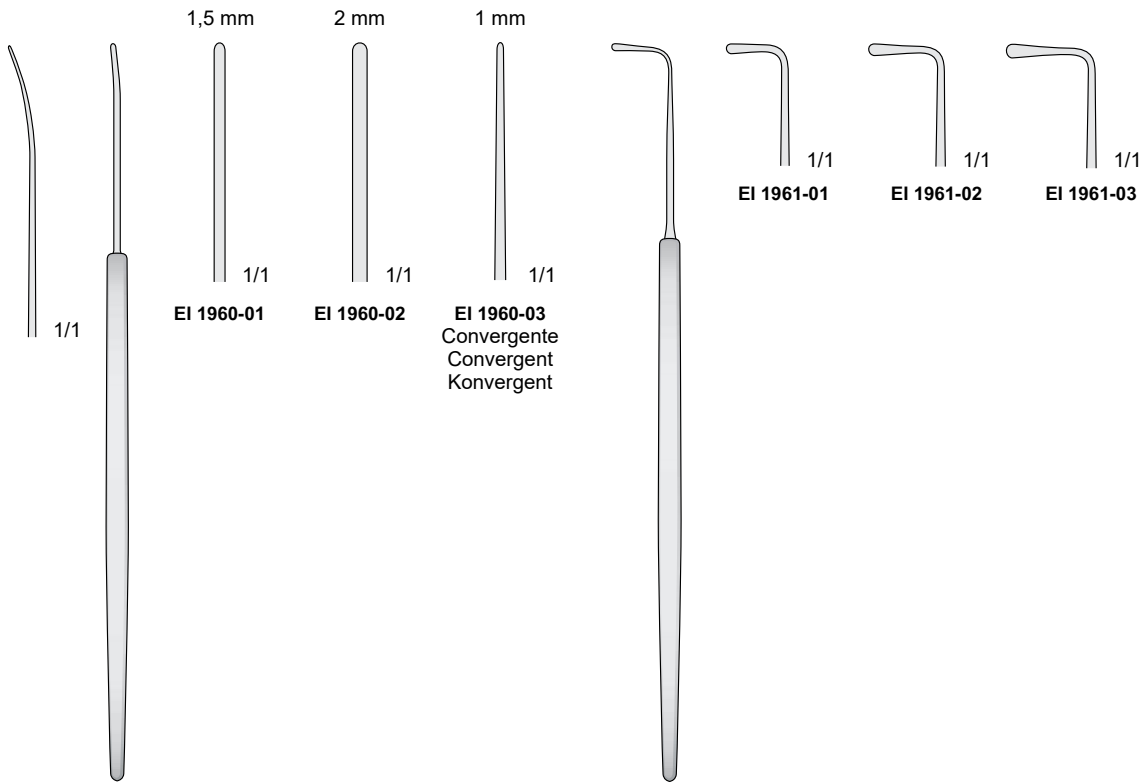

1,5 mm
 EI 1960-01
 1/1

2 mm
 EI 1960-02
 1/1

1 mm
 EI 1960-03
 Convergente
 Convergent
 Konvergent

EI 1961-01
 1/1

EI 1961-02
 1/1

EI 1961-03
 1/1

WECKER
 EI 1960-01 / EI 1960-03
 13 cm

GRAEFE
 EI 1961-01 / EI 1961-03
 13 cm

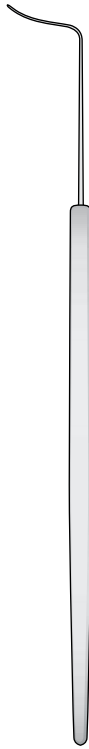

CASTROVIEJO
EI 1962-01 / EI 1962-06
13 cm

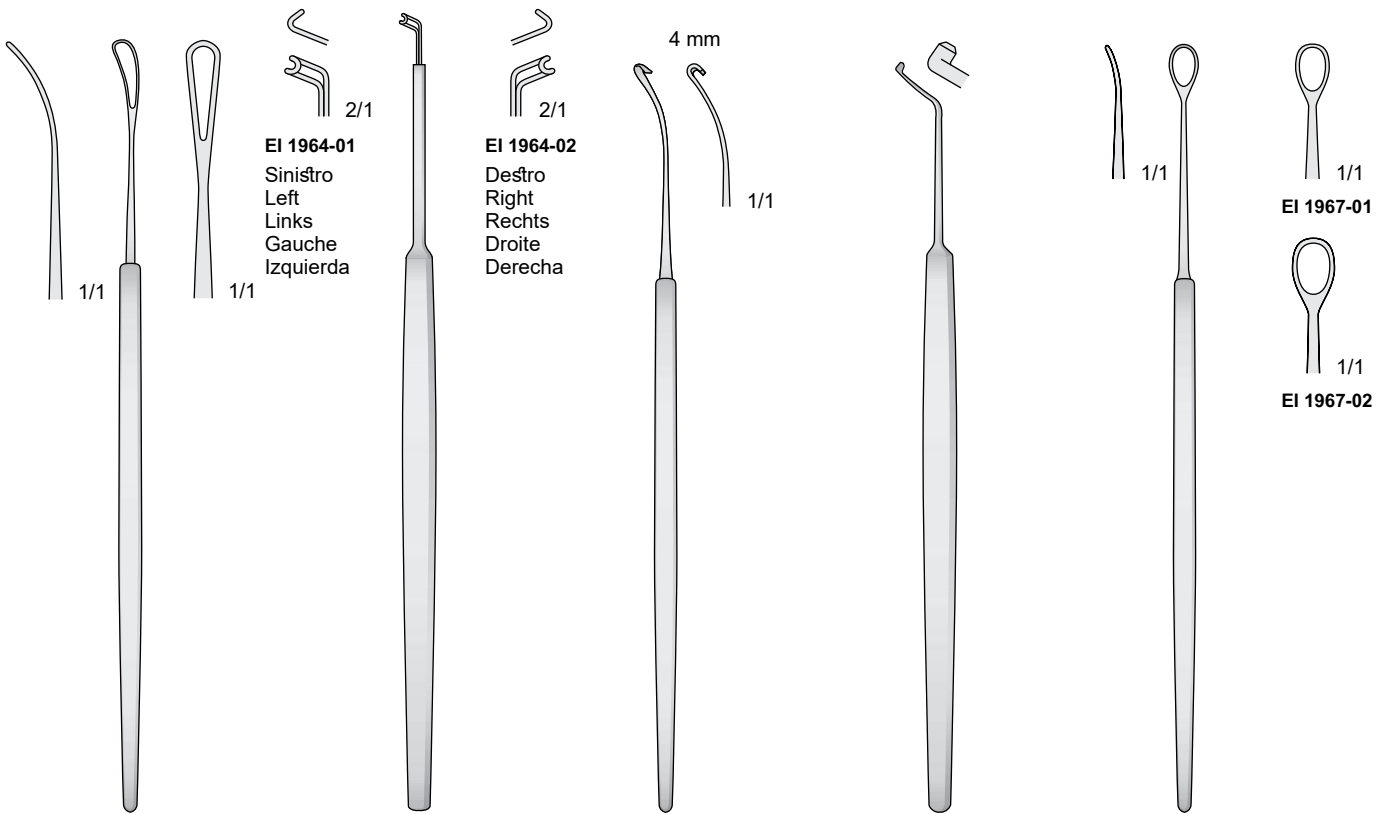

SNELLEN
EI 1963-13 13.5 cm EI 1964-01 / EI 1964-02 14 cm EI 1965-13 13 cm EI 1966-13 13 cm EI 1967-01 / EI 1967-02 13.5 cm

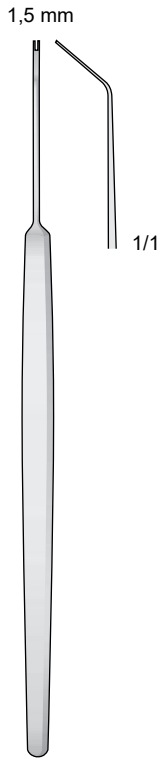

EI 1968-13 13 cm

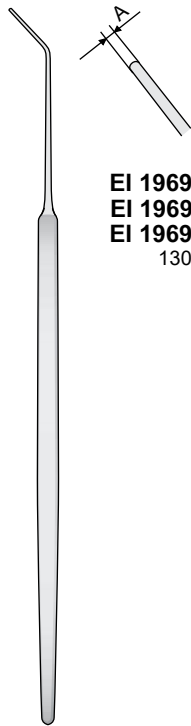

EI 1969-01 0,6 mm
EI 1969-02 1,0 mm
EI 1969-03 1,5 mm
 130 mm

CASTROVIEJO
EI 1969-01 / EI 1969-03
 13 cm



EI 1970-14 14 cm



EI 1971-16 16.5 cm



KIMURA
EI 1972-15
 15 cm

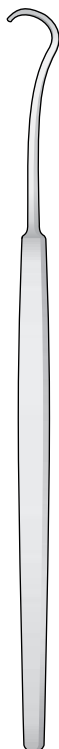

ARRUGA
EI 1973-14
 14 cm

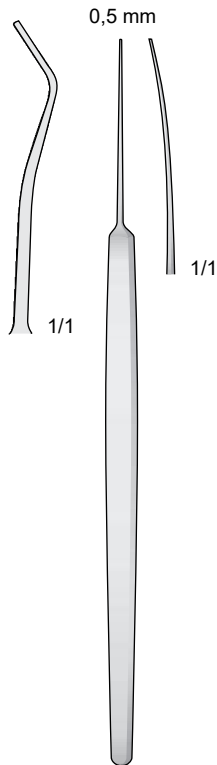

EI 1974-13
 13 cm

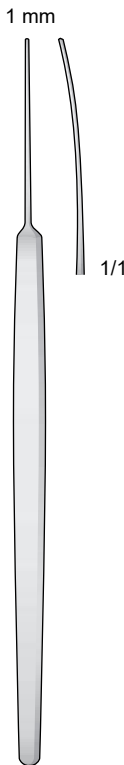

EI 1975-13
 13 cm

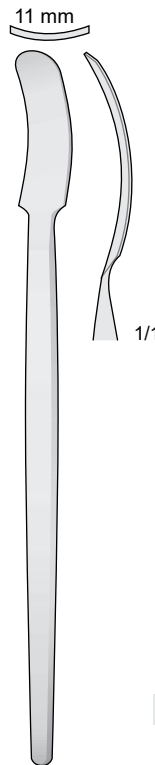

EI 1976-12
 12.5 cm

Dilatatori lacimali
 Tränenkanal Dilatadoren
 Lacrymal dilators
 Dilatadores lacrimales

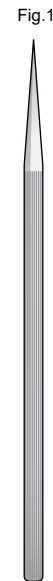

WILDER
EI 1977-10
 10 cm



WILDER
EI 1978-10
 10 cm

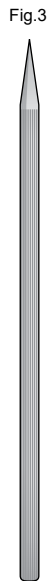

WILDER
EI 1979-10
 10 cm

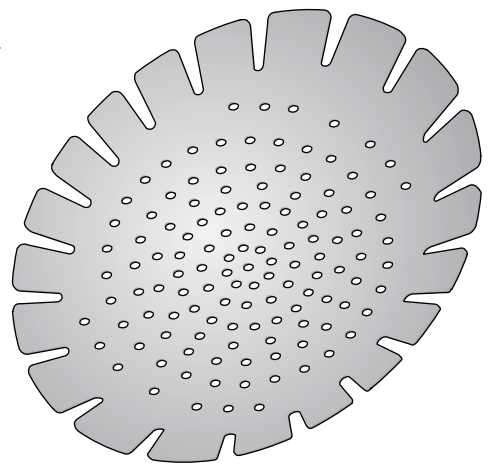
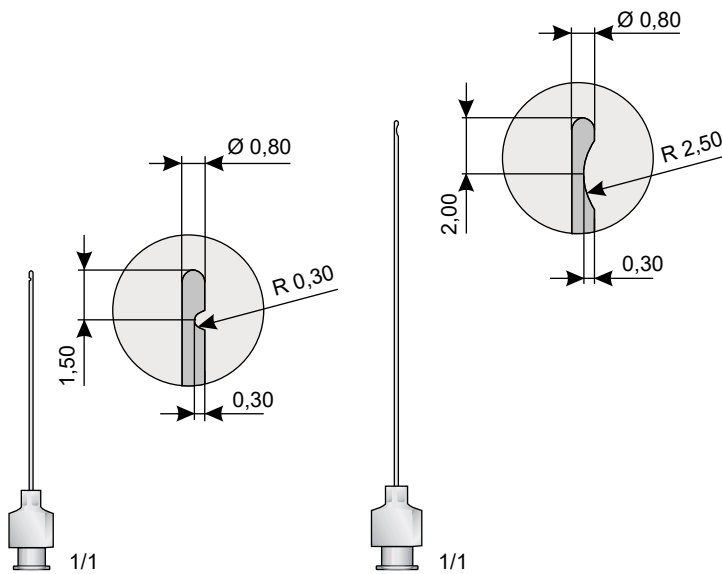
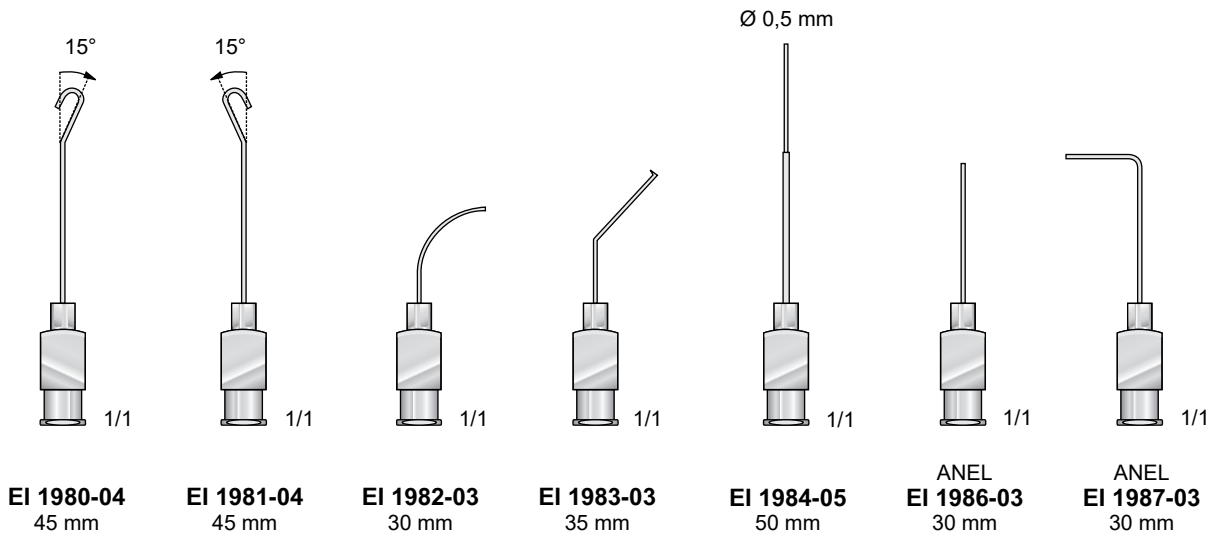

EI 1988-04 04 cm

EI 1989-06 06 cm

EI 1990-07 7.5 cm

Micro Pinzette - Micro Forceps - Mikro Pinzetten - Micro pincers - Pinzas finas

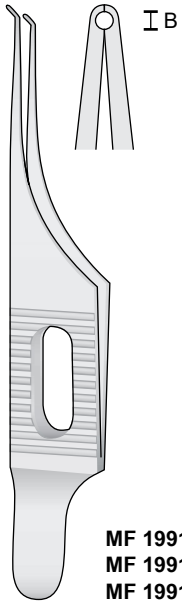

MF 1991-01 0,2 mm
MF 1991-02 0,3 mm
MF 1991-03 0,4 mm

PIERSE

MF 1991-01 / MF 1991-03
 8 cm

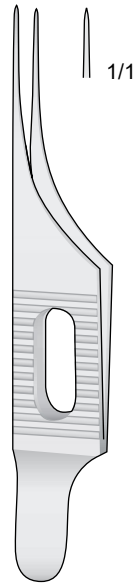

B
MF 1992-08 0,8 mm

COLIBRI

MF 1992-08 08 cm

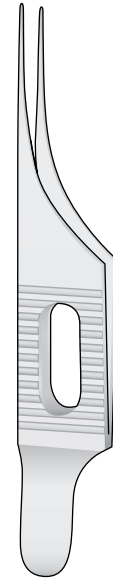

A
MF 1993-01 0,25 mm
MF 1993-02 0,4 mm
MF 1993-03 0,6 mm

COLIBRI

MF 1993-01 / MF 1993-03
 7.5 cm

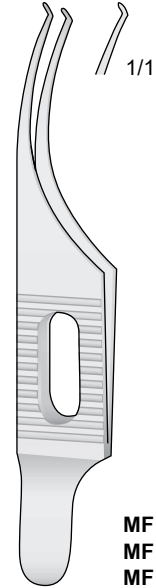

A
MF 1994-01 0,25 mm
MF 1994-02 0,4 mm
MF 1994-03 0,6 mm

COLIBRI

MF 1994-01 / MF 1994-03
 8 cm

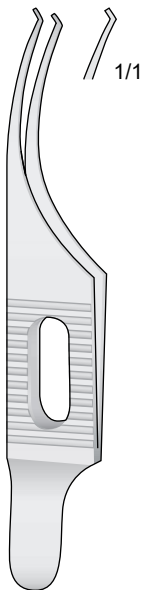

COLIBRI

MF 1995-08 08 cm

⌀ 5/1

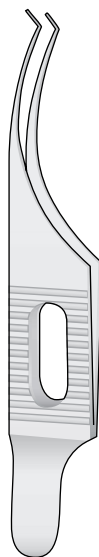

MF 1996-07 07 cm

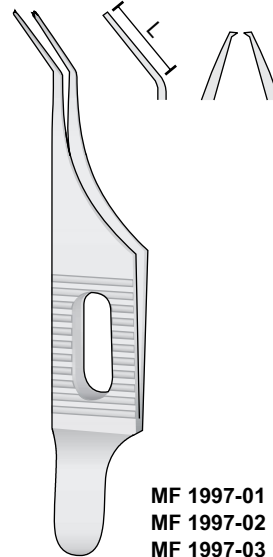

L
MF 1997-01 8 mm
MF 1997-02 10 mm
MF 1997-03 12 mm

MF 1997-01 / MF 1997-03
 7 cm

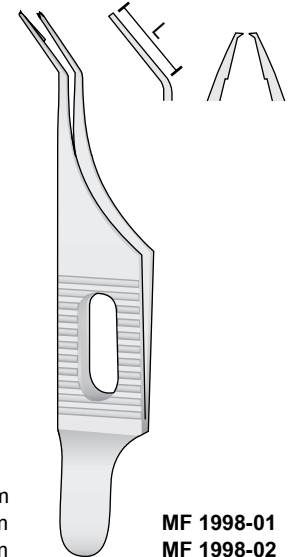

L
MF 1998-01 8 mm
MF 1998-02 10 mm

MF 1998-01 / MF 1998-02
 7 cm

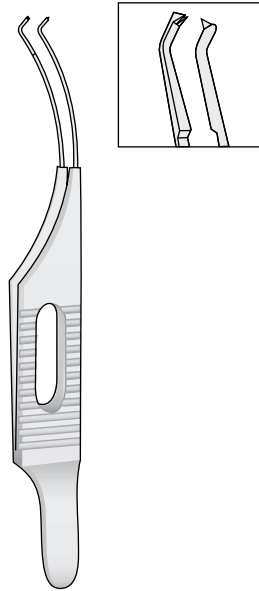

BARRAQUER
EI 1999

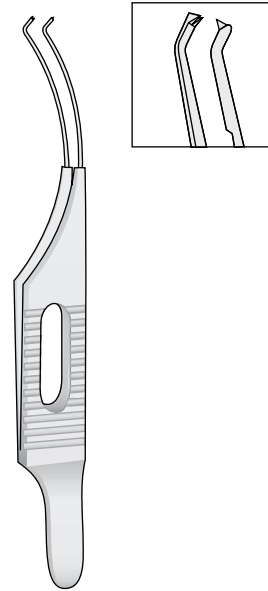

BARRAQUER
EI 2000



EI 2001-09 9.5 cm

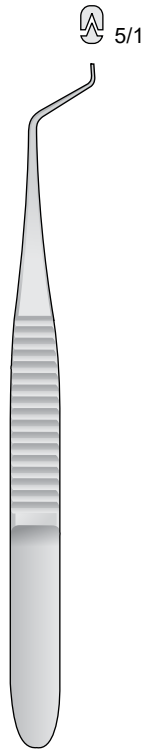

EI 2002-09 09 cm

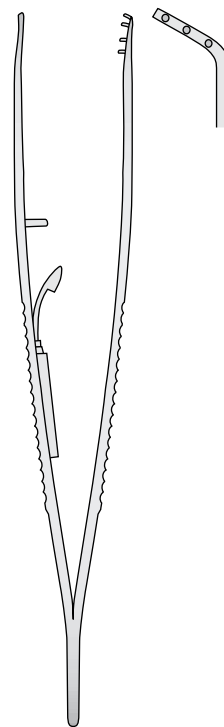

EI 2003-09 9.5 cm

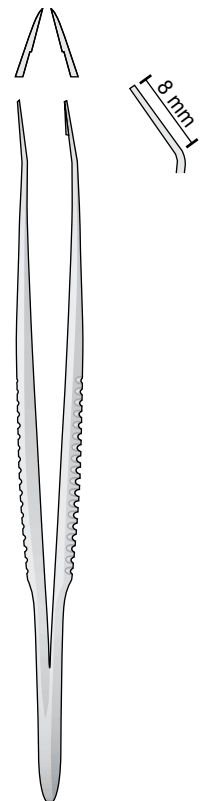

Mc PHERSON
EI 2004-09 9.5 cm

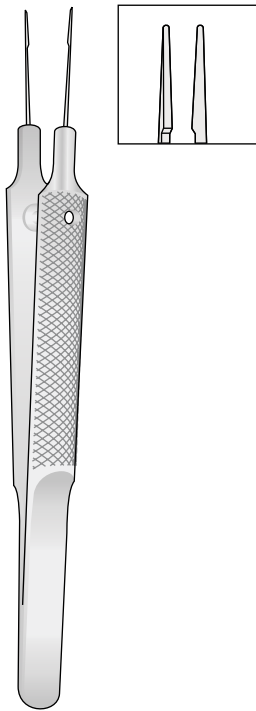

EI 2005

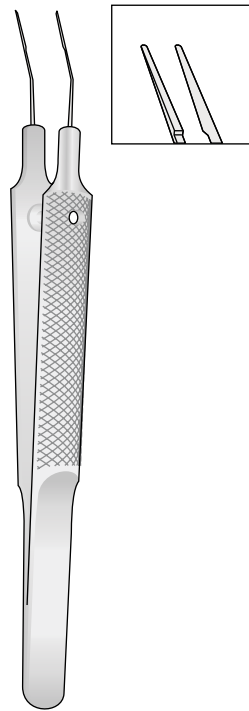

EI 2006

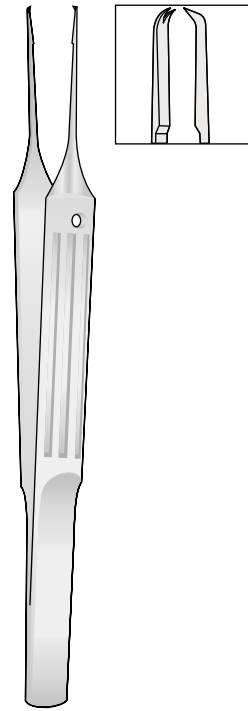

**CASTROVIEJO
 EI 2007**

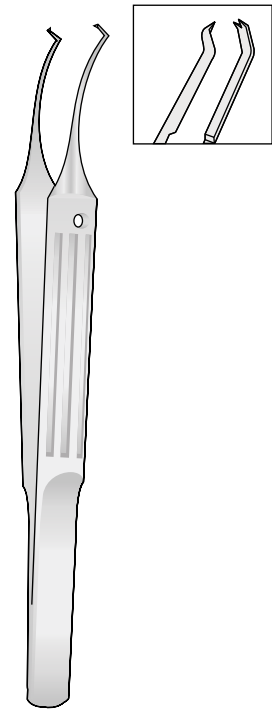

**TROUTMAN
 EI 2008**

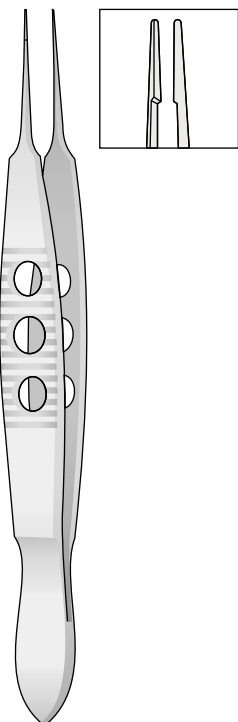

**MC PHERSON
 EI 2009**

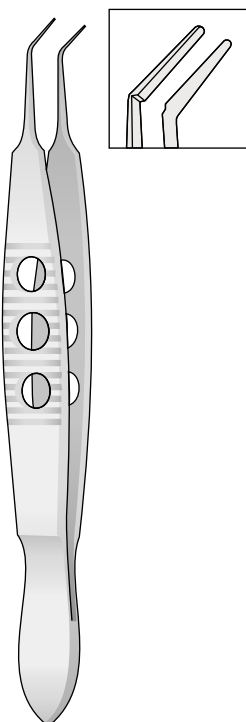

**MC PHERSON
 EI 2010**

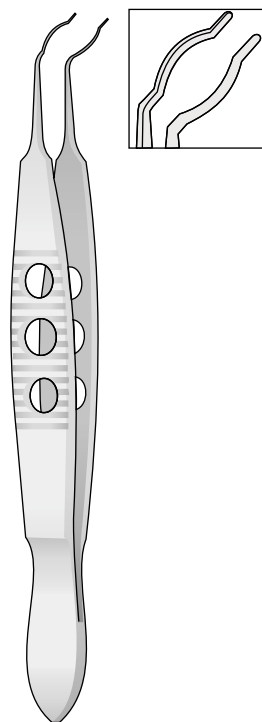

**OSHIKA-FAULKNER
 EI 2011**

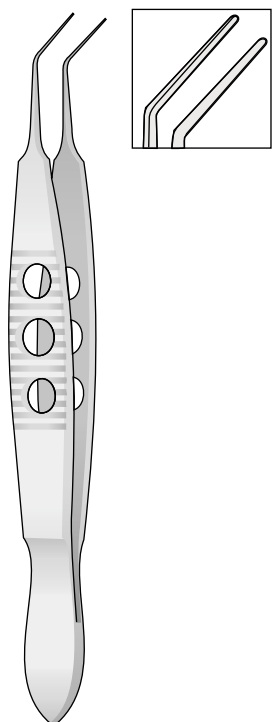

**FAULKNER
 EI 2012**

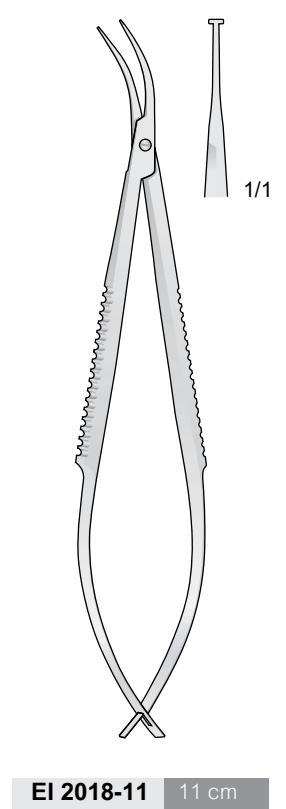
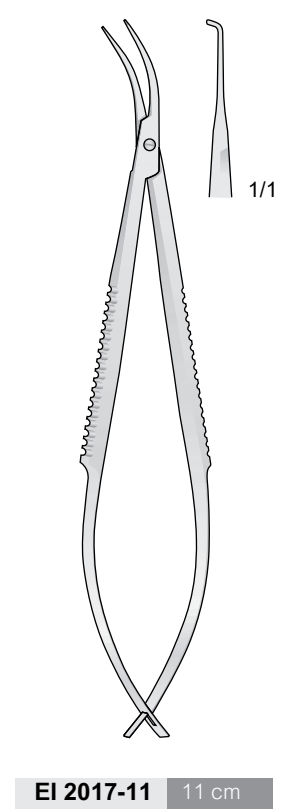
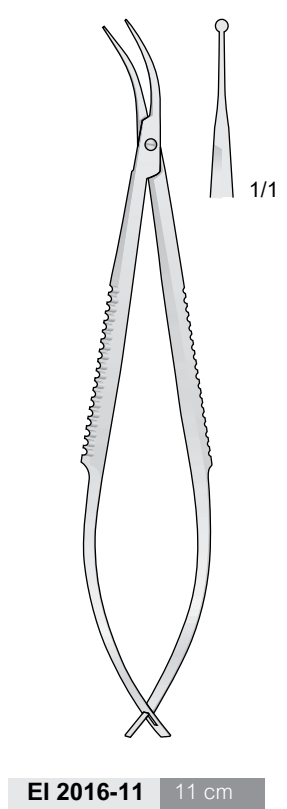
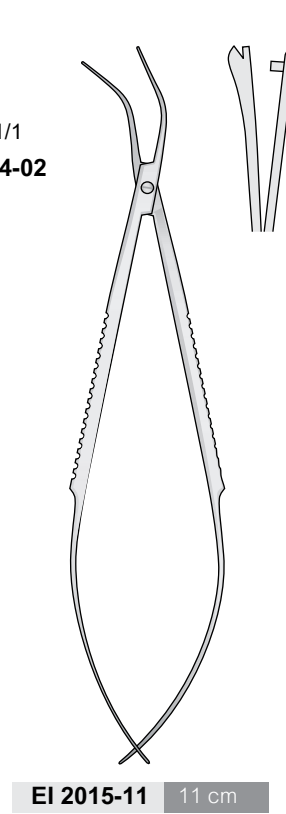
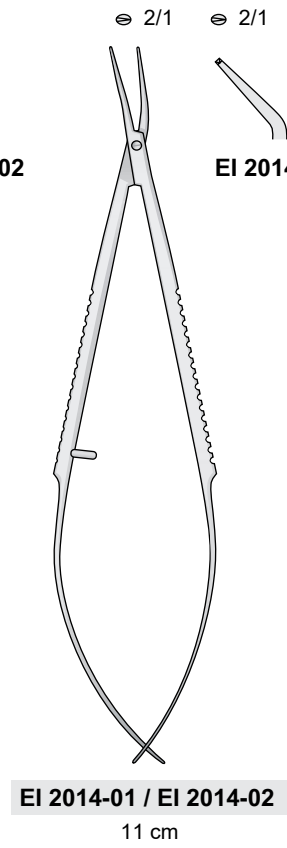
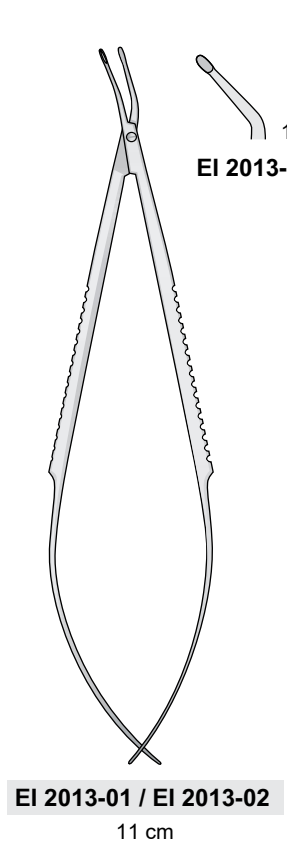

Blefarostati - Eye specula - Sperrelevatoren
 Blèpharostats - Blefarostatos

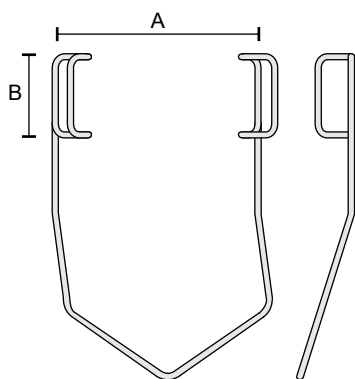

	A	B
EI 2019-27	2.7 cm	1.1 cm

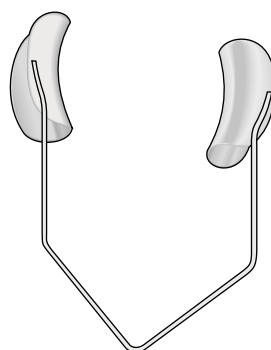

BARRAQUER
EI 2020

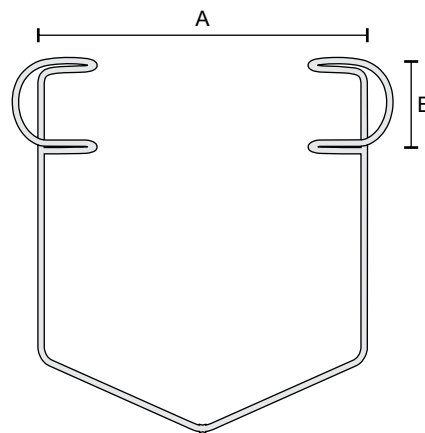

	A	B
EI 2021-01	2.7 cm	0.5 cm
EI 2021-02	3.4 cm	0.9 cm
EI 2021-03	4.2 cm	1.2 cm
EI 2021-04	4.2 cm	1.4 cm

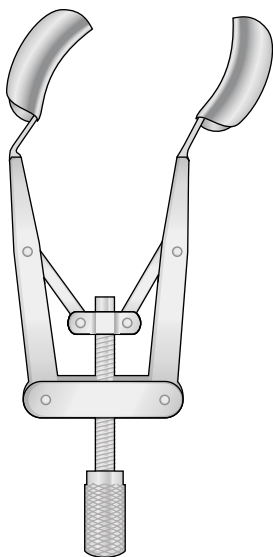

KERSHNER
EI 2022

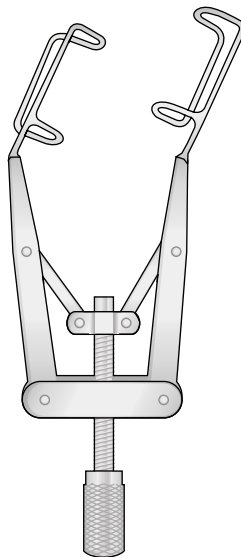

KERSHNER
EI 2023

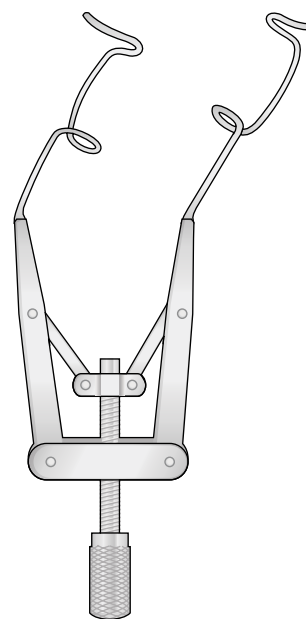

LIEBERMANN-TENNANT
EI 2024

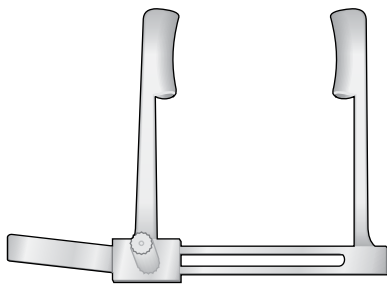

PROST
MF 2025

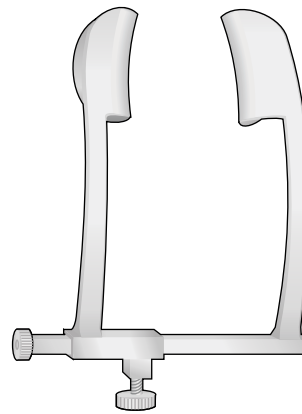

COOK
MF 2026

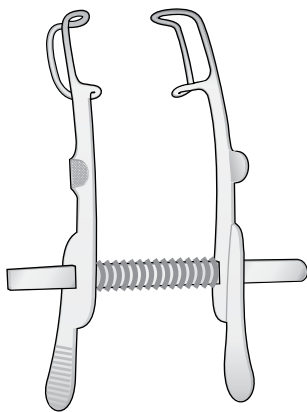

MELLINGER
MF 2027-07 07 cm

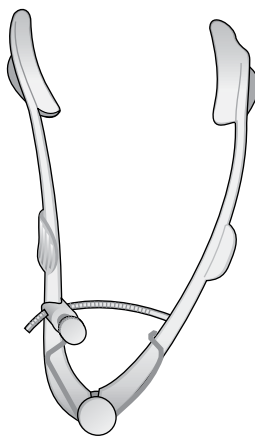

LISTER-BURCH
MF 2028-08 08 cm

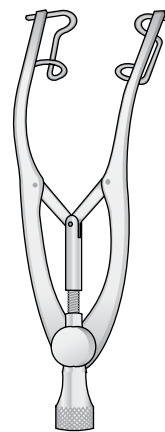

CASTROVIEJO
MF 2029-08 08 cm

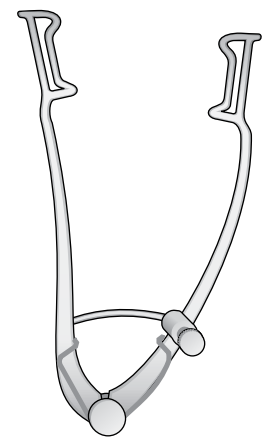

WILLIAMS
MF 2030-08 08 cm

Micro forbici
 Micro scissors
 Micro Scheren
 Micro ciseaux
 Micro tijeras

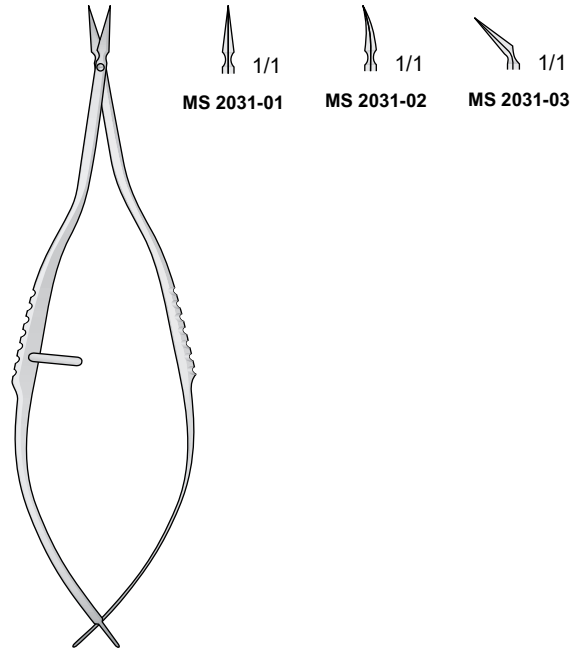

VANNAS
MS 2031-01 / MS 2031-03
 8.5 cm

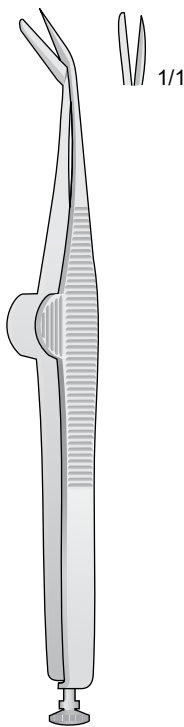

WECKER
MS 2032-11 11 cm

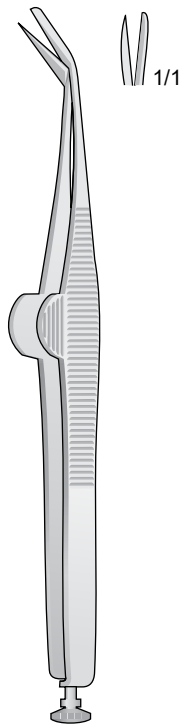

WECKER
MS 2033-11 11 cm

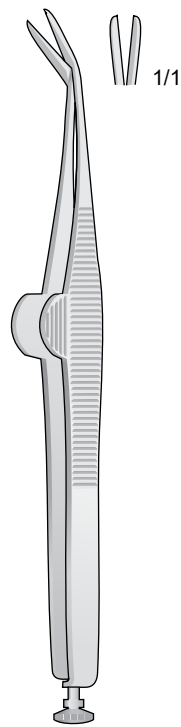

WECKER
MS 2034-11 11 cm

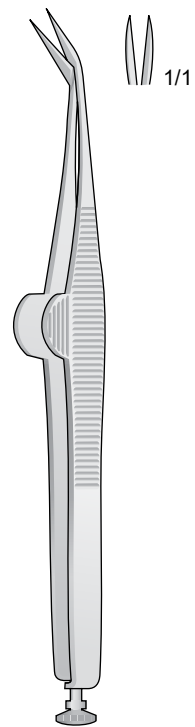

WECKER
MS 2035-11 11 cm

Acuta - Sharp - Spitz
Pointu - Agudas

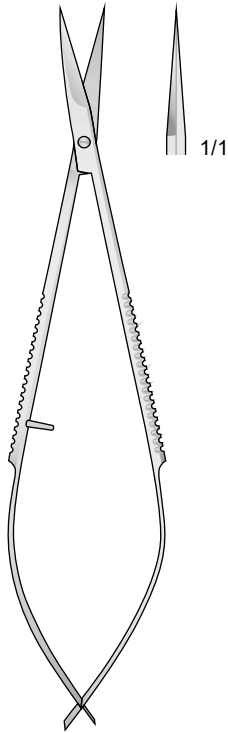

NOYES
MS 2036-12 12 cm

Acuta - Sharp - Spitz
Pointu - Agudas

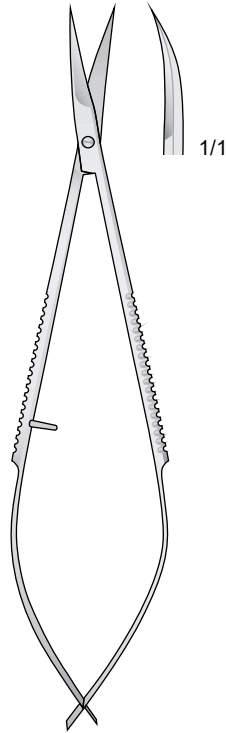

NOYES
MS 2037-12 12 cm

Acuta - Sharp - Spitz
Pointu - Agudas

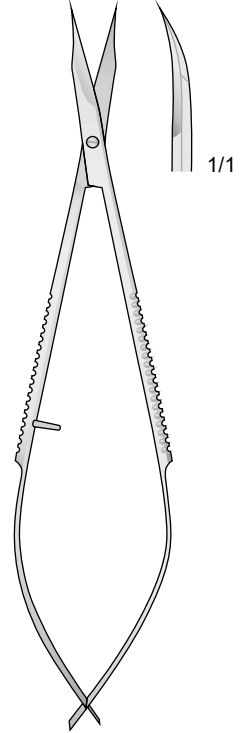

WESTCOTT
MS 2038-12 12 cm

Acuta - Sharp - Spitz
Pointu - Agudas

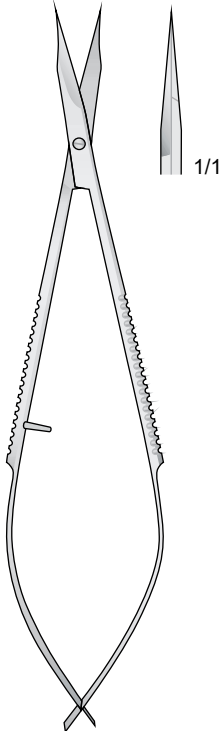

WESTCOTT
MS 2038-12 12 cm

Smussa - Blunt - Stumpf
Mousse - Romas

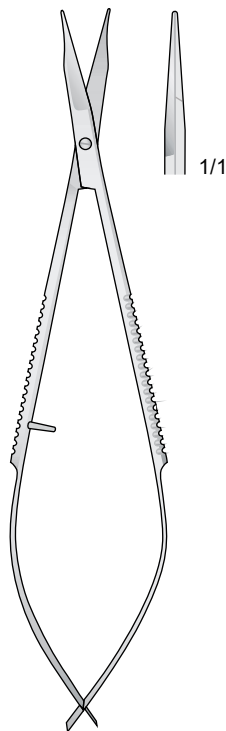

WESTCOTT
MS 2039-12 12 cm

Smussa - Blunt - Stumpf
Mousse - Romas

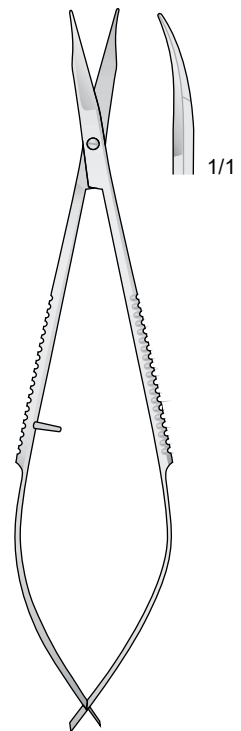

WESTCOTT
MS 2040-12 12 cm

Micro forbici
 Micro scissors
 Micro Scheren
 Micro ciseaux
 Micro tijeras

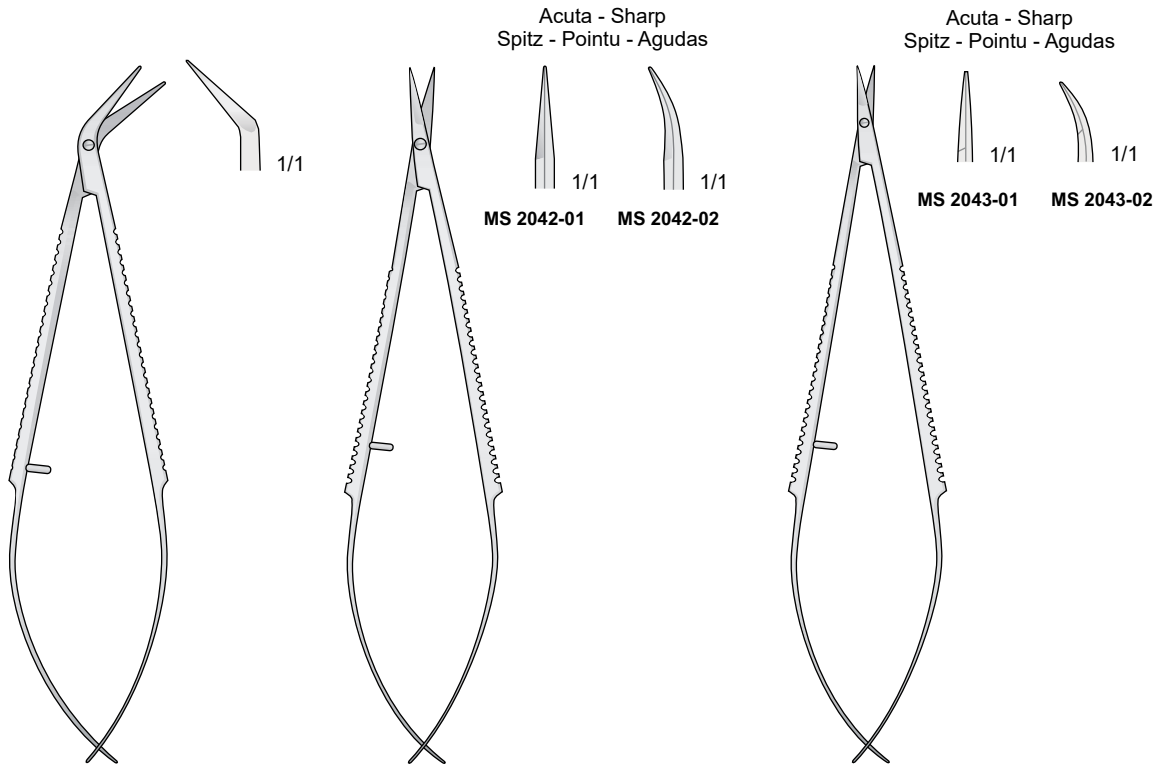

MS 2041-11 11 cm

MS 2042-01 / MS 2042-02
11 cm

MS 2043-01 / MS 2043-02
11 cm

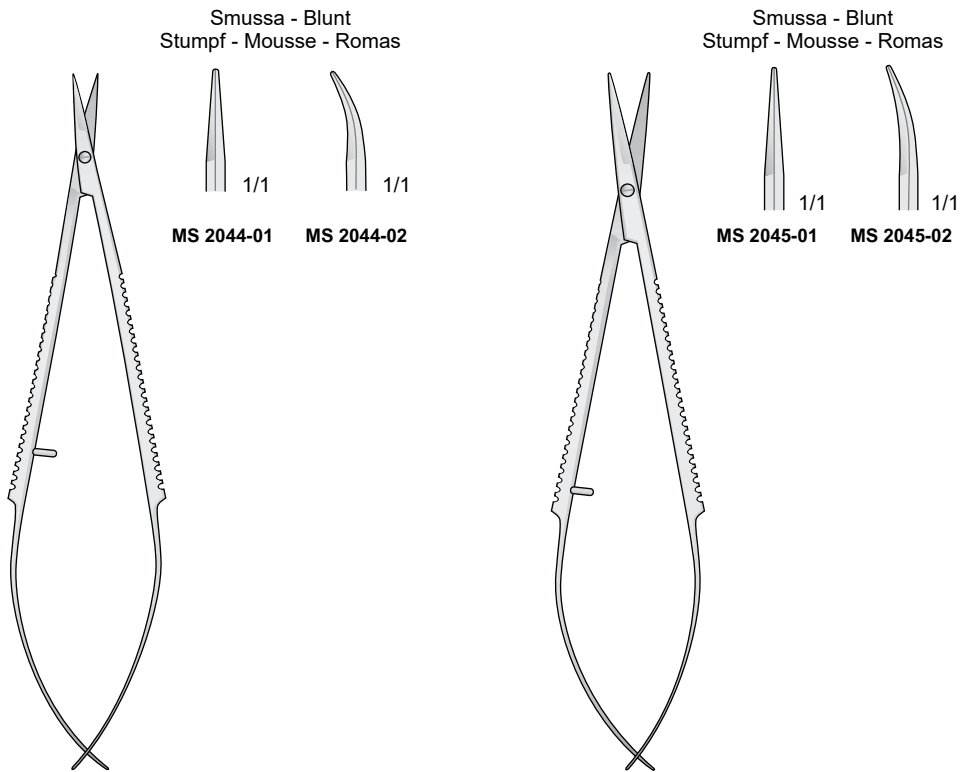

MS 2044-01 / MS 2044-02
11 cm

MS 2045-01 / MS 2045-02
12 cm

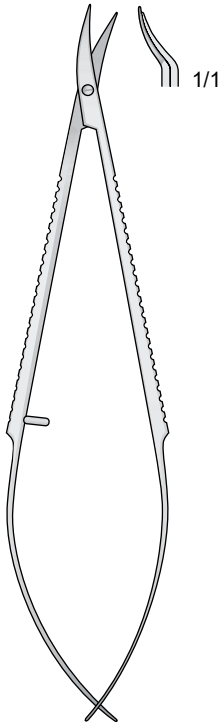

**TROUTMAN
MS 2046-11**
11 cm

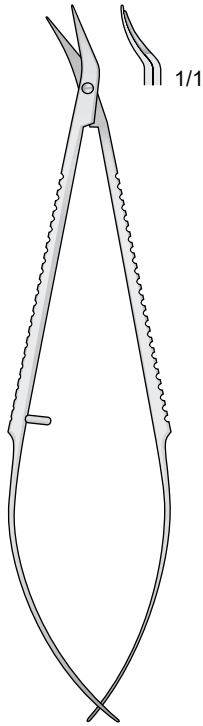

**TROUTMAN
MS 2047-11**
11 cm

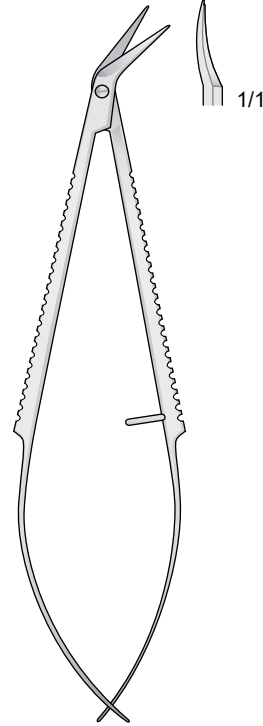

**CASTROVIEJO
MS 2048-11**
11 cm

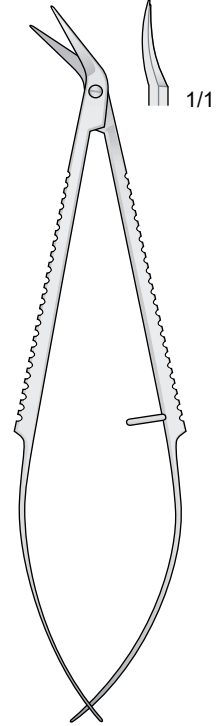

**CASTROVIEJO
MS 2049-11**
11 cm

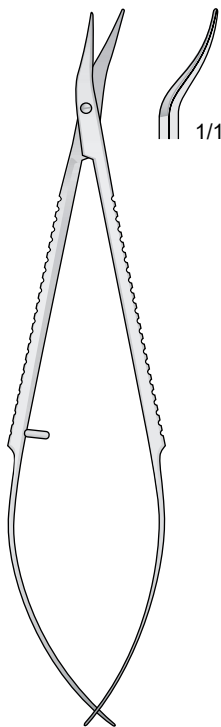

**CASTROVIEJO
MS 2050-11**
11 cm

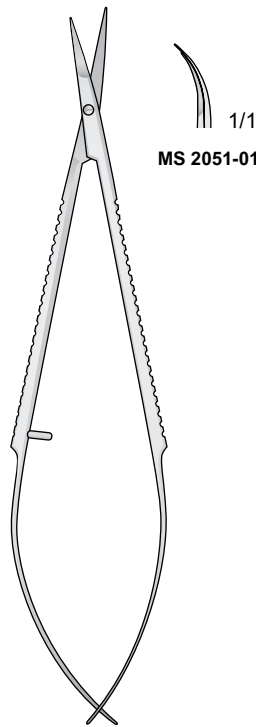

MS 2051-01 / MS 2051-02
11 cm

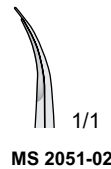

MS 2051-02

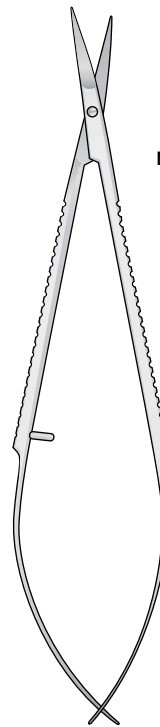

MS 2052-01 / MS 2052-02
11 cm



MS 2052-01

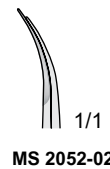

MS 2052-02

Micro forbici
Micro scissors
Micro Scheren
Micro ciseaux
Micro tijeras

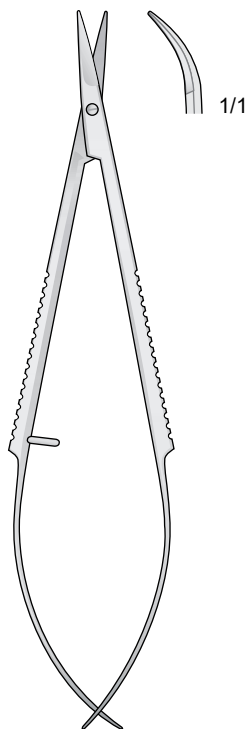
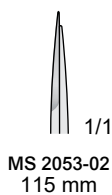
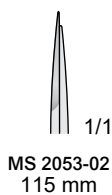
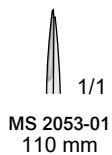
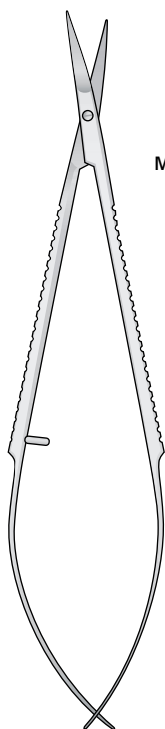

MS 2053-01 / MS 2053-02

MS 2054-11 11.5 cm

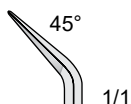
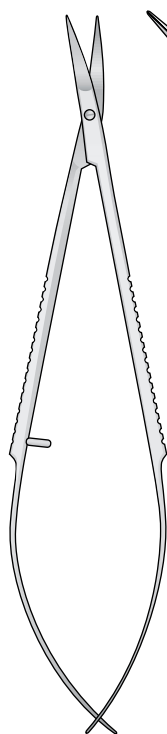

MS 2055-11 11 cm

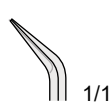
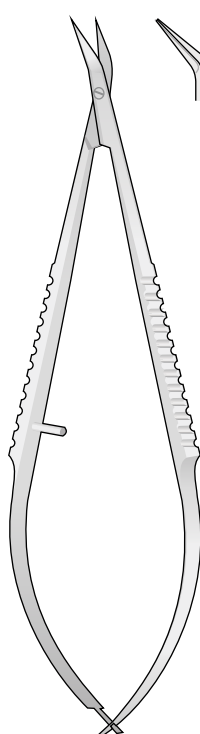

MS 2056-11 11 cm

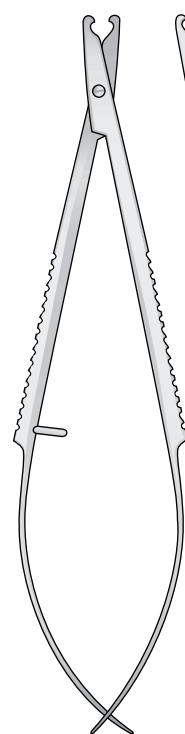

MS 2057-11 11 cm

Acuta - Sharp - Spitz - Pointu - Agudas

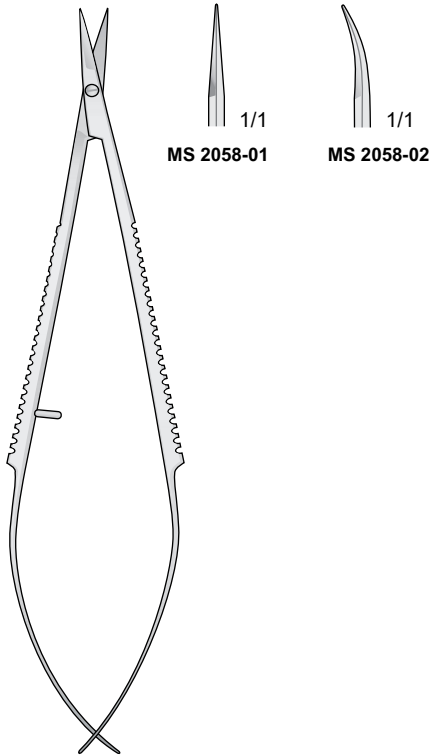

MS 2058-01 / MS 2058-02

13 cm

Acuta - Sharp - Spitz - Pointu - Agudas

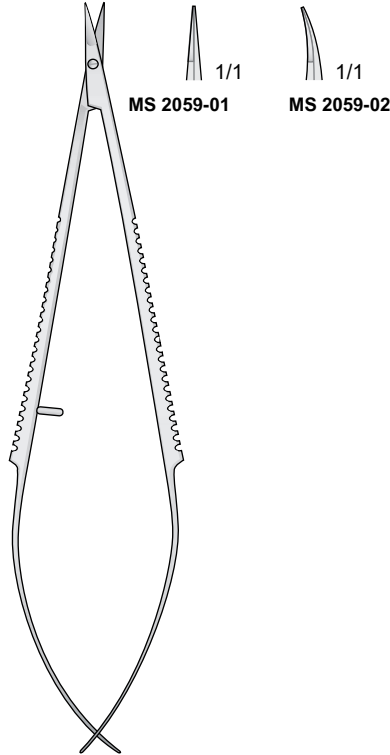

MS 2059-01 / MS 2059-02

13 cm

Smussa - Blunt - Stumpf - Mousse - Romas

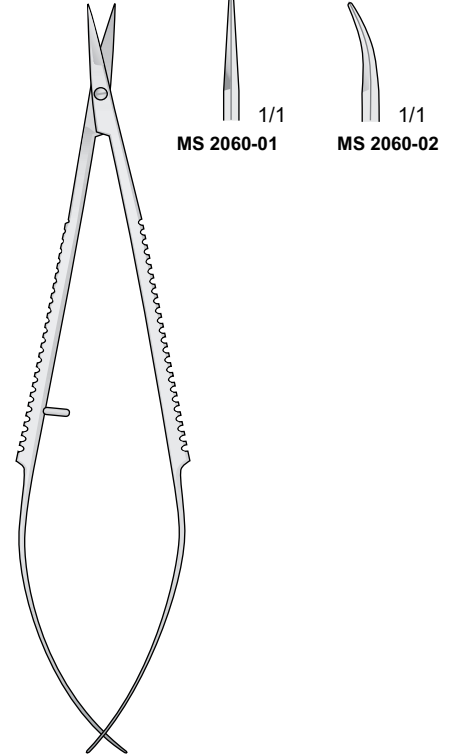

MS 2060-01 / MS 2060-02

13 cm

Acuta - Sharp - Spitz - Pointu - Agudas

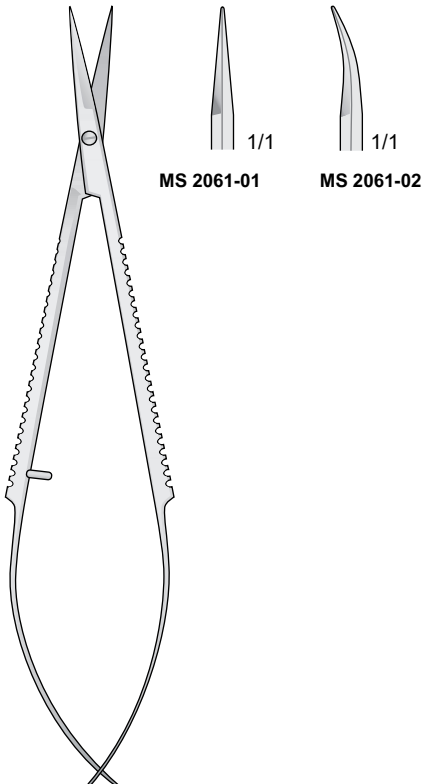

MS 2061-01 / MS 2061-02

13.5 cm

Smussa - Blunt - Stumpf - Mousse - Romas

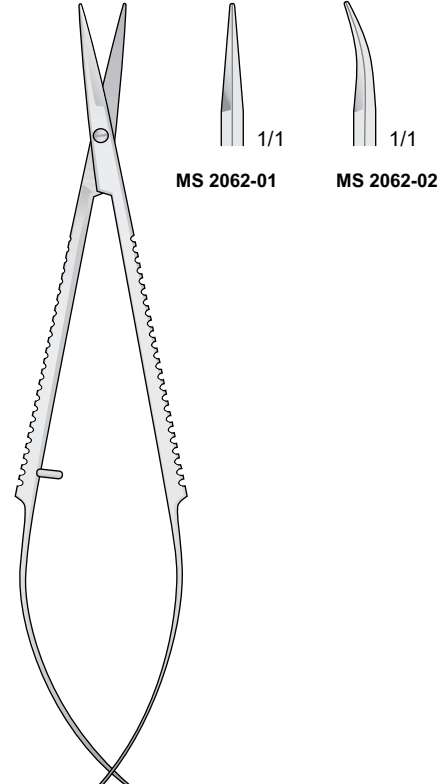

MS 2062-01 / MS 2062-02

13.5 cm

Micro port'agh
Micro needle holder
Micro Nadelhalte
Micro porte aiguille
Micro portaagujas

Acuta - Sharp
Spitz - Pointu - Agudas



1/1



1/1

MNH 2063-01

MNH 2063-02



1/1



1/1

MNH 2064-01

MNH 2064-02

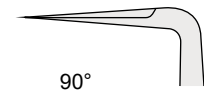

90°

1/1

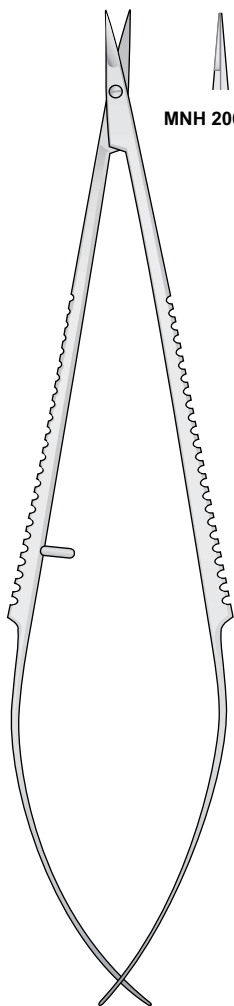

MNH 2063-01 / MNH 2063-02

16 cm

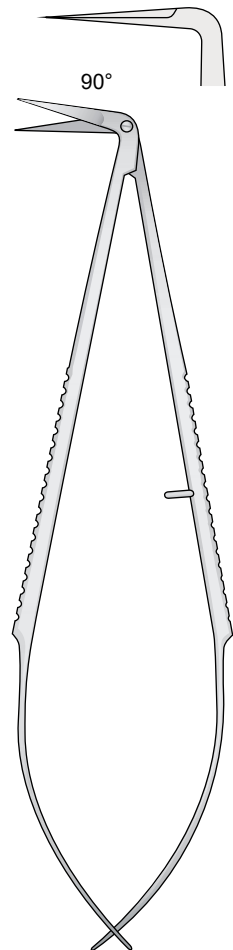
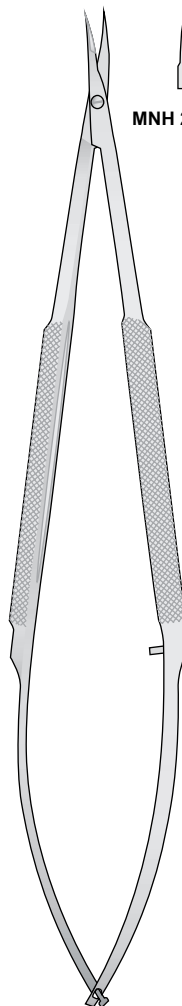

MNH 2065-15 15 cm



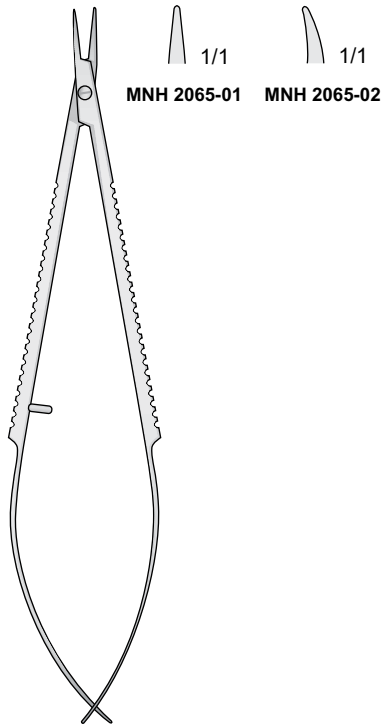

MNH 2065-01 MNH 2065-02

MNH 2065-01 / MNH 2065-02

11 cm

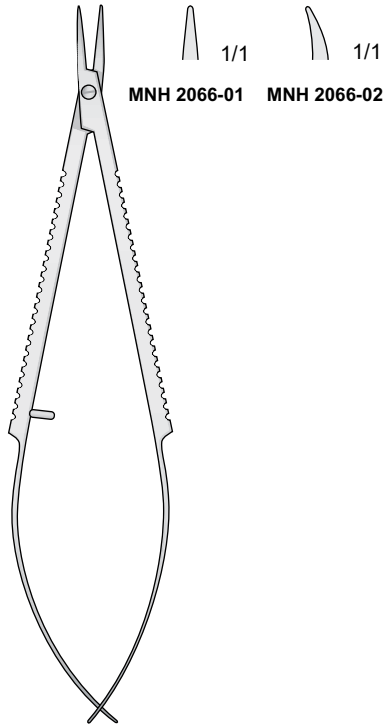

MNH 2066-01 MNH 2066-02

MNH 2066-01 / MNH 2066-02

11 cm

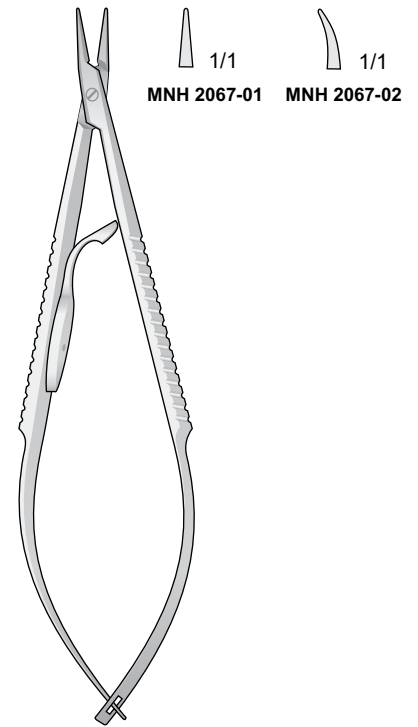

MNH 2067-01 MNH 2067-02

MNH 2067-01 / MNH 2067-02

11 cm

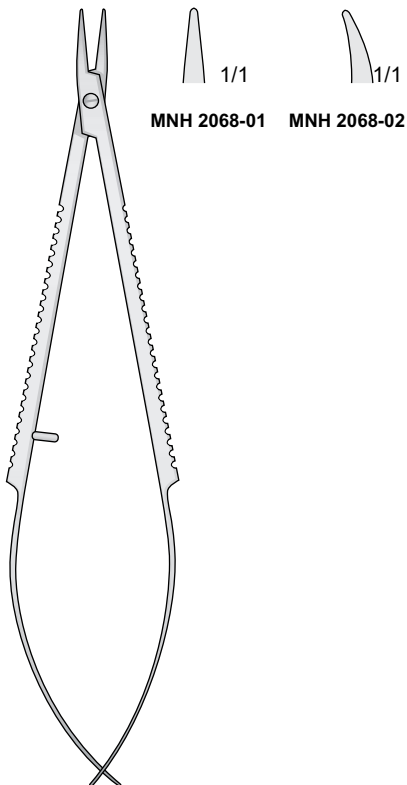

MNH 2068-01 MNH 2068-02

MNH 2068-01 / MNH 2068-02

12.5 cm

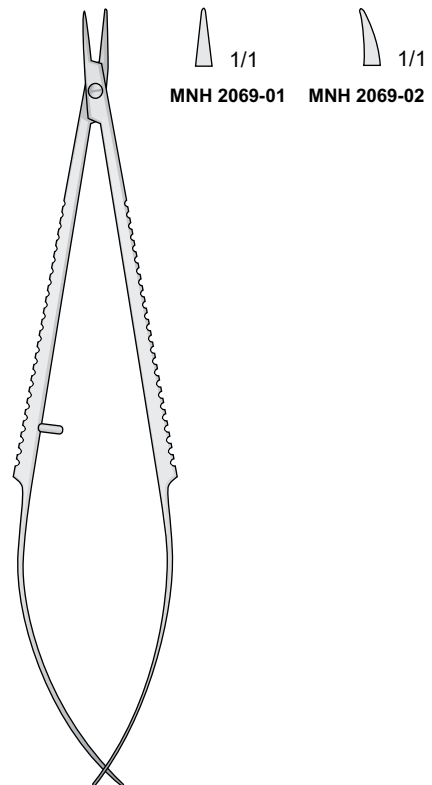

MNH 2069-01 MNH 2069-02

MNH 2069-01 / MNH 2069-02

12.5 cm

Micro port'agh
 Micro needle holder
 Micro Nadelhalte
 Micro porte aiguille
 Micro portaagujas

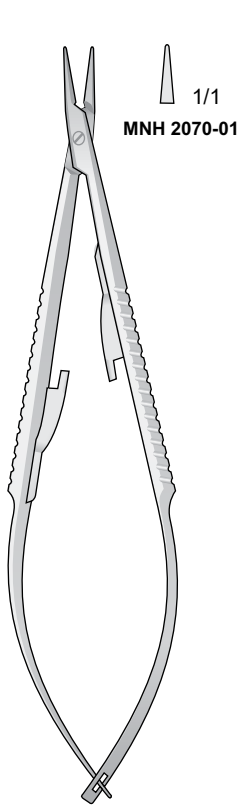

 1/1
MNH 2070-01

 1/1
MNH 2070-02

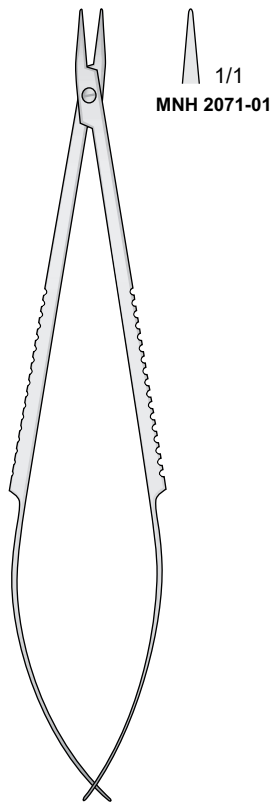

 1/1
MNH 2071-01

 1/1
MNH 2071-02

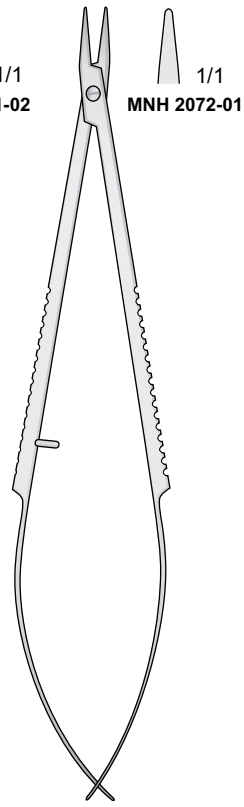

 1/1
MNH 2072-01

 1/1
MNH 2072-02

MNH 2070-01 / MNH 2070-02
 12.5 cm

MNH 2071-01 / MNH 2071-02
 13.5 cm

MNH 2072-01 / MNH 2072-02
 13.5 cm

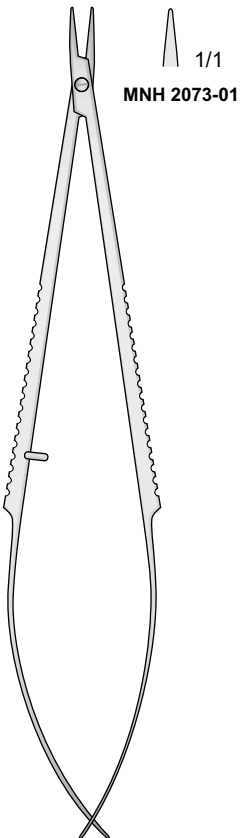

 1/1
MNH 2073-01

 1/1
MNH 2073-02

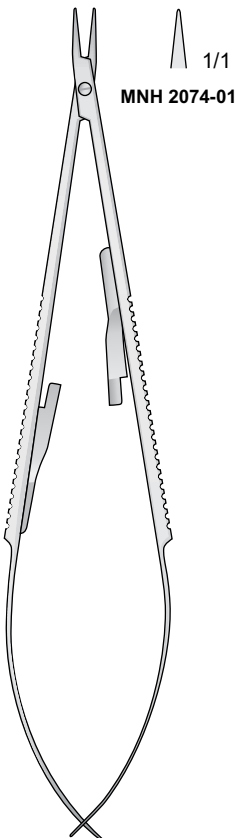

 1/1
MNH 2074-01

 1/1
MNH 2074-02

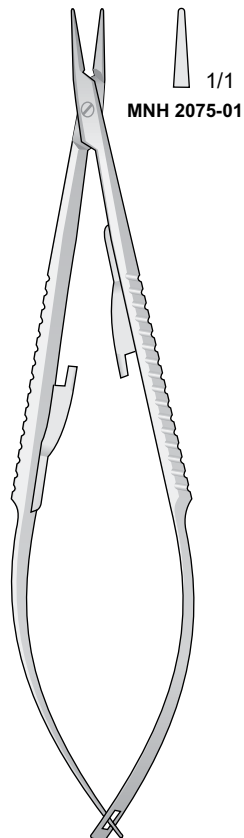

 1/1
MNH 2075-01

 1/1
MNH 2075-02

MNH 2073-01 / MNH 2073-02
 13.5 cm

MNH 2074-01 / MNH 2074-02
 13.5 cm

MNH 2075-01 / MNH 2075-02
 13.5 cm

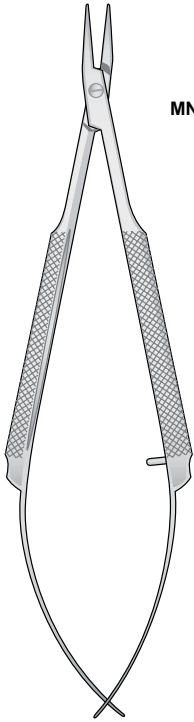

CASTROVIEJO
MNH 2076-01 / MNH 2076-02
11 cm

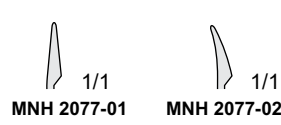
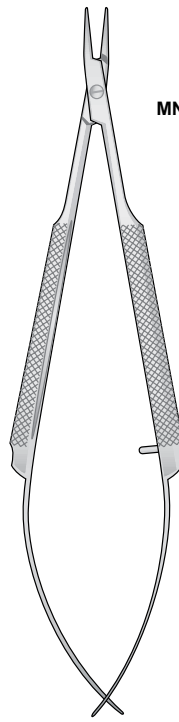

CASTROVIEJO
MNH 2077-01 / MNH 2077-02
11 cm

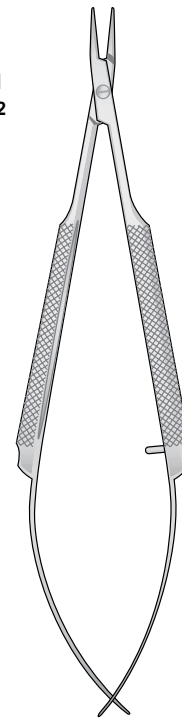

CASTROVIEJO
MNH 2078-11 11 cm

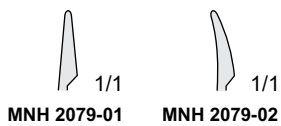
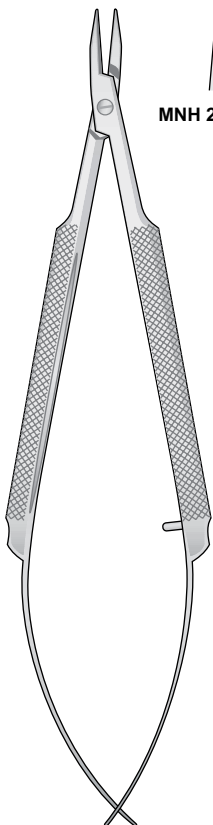

CASTROVIEJO
MNH 2079-01 / MNH 2079-02
12.5 cm

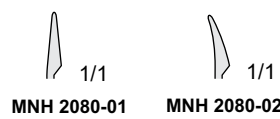
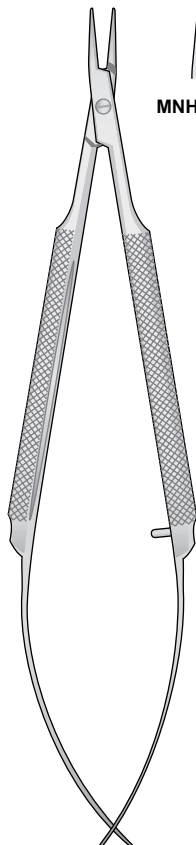

CASTROVIEJO
MNH 2080-01 / MNH 2080-02
12.5 cm

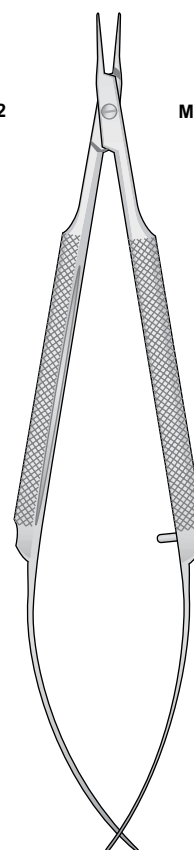

BARRAQUER
MNH 2081-01 / MNH 2081-02
12.5 cm

Micro port'agh
 Micro needle holder
 Micro Nadelhalte
 Micro porte aiguille
 Micro portaagujas

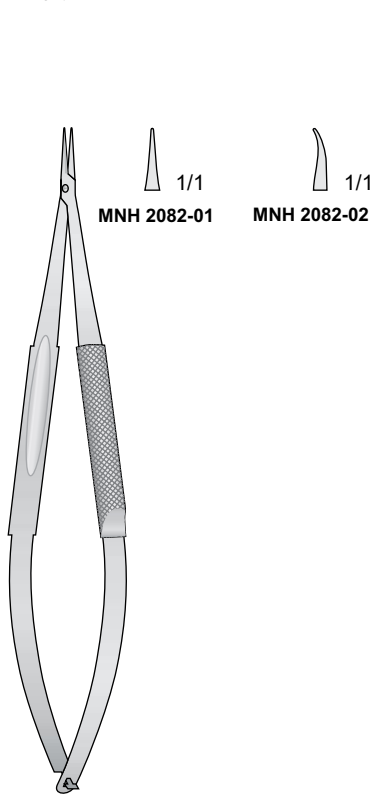

BARRAQUER
MNH 2082-01 / MNH 2082-02
 12.5 cm

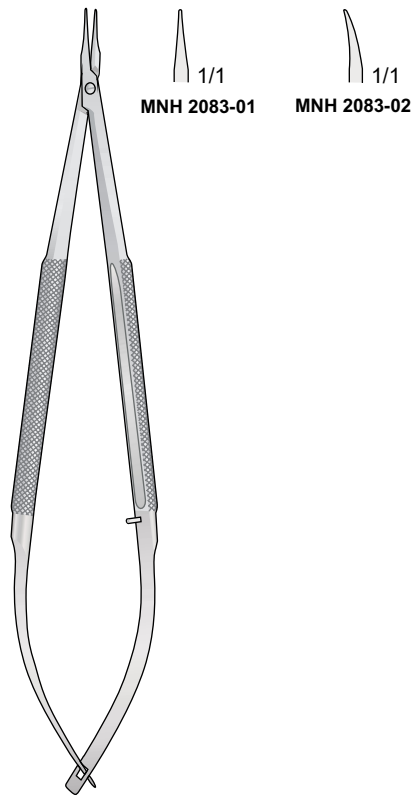

BARRAQUER
MNH 2083-01 / MNH 2083-02
 15 cm

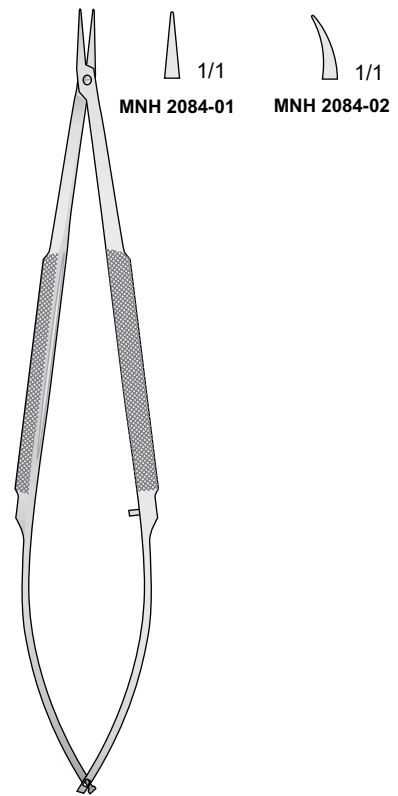

REILL
MNH 2084-01 / MNH 2084-02
 15 cm

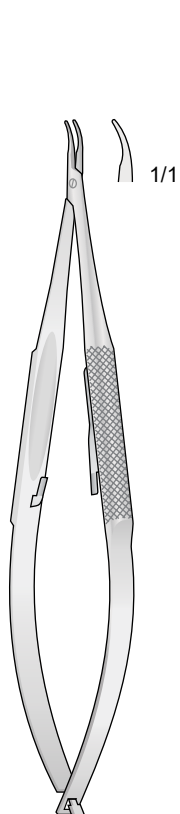

BARRAQUER
MNH 2085-12 12 cm

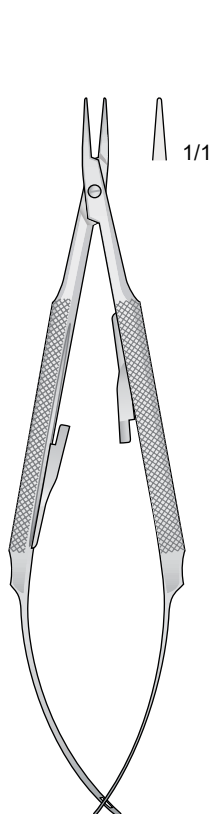

BARRAQUER
MNH 2086-12 12.5 cm

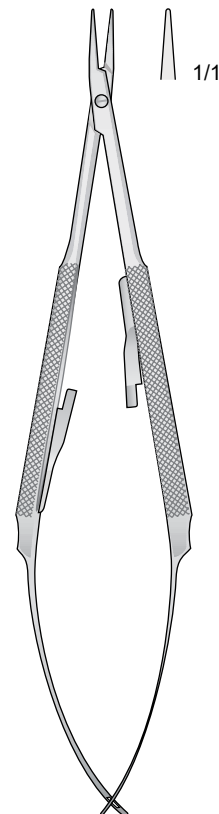

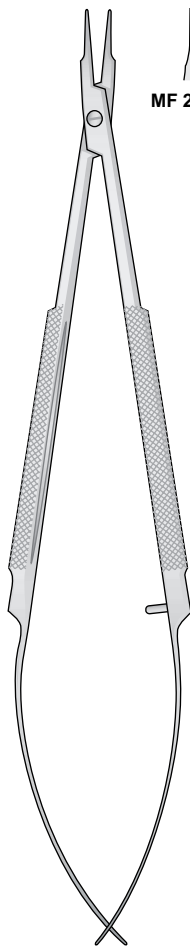

BARRAQUER
MNH 2087-12 12.5 cm

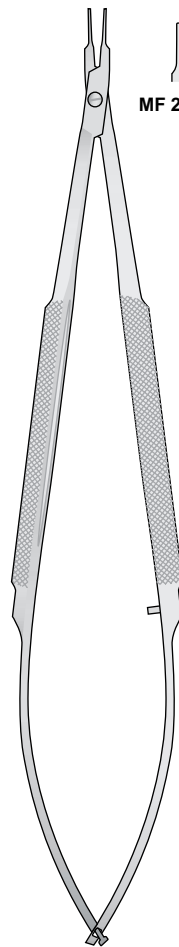

 1/1
MF 2088-01

 1/1
MF 2088-02



 1/1
MF 2089-01

 1/1
MF 2089-02

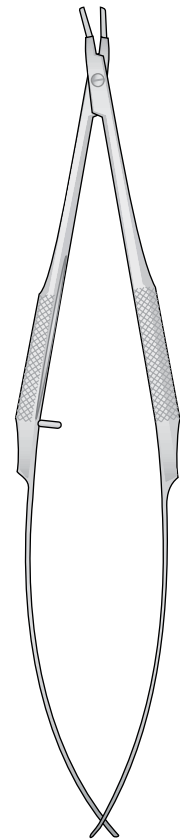

 1/1

BARRAQUER
MF 2088-01 / MF 2088-02
15 cm

BARRAQUER
MF 2089-01 / MF 2089-02
15 cm

BARRAQUER
MF 2090-13 13.5 cm

Micro Pinzette
 Micro Forceps
 Mikro Pinzetten
 Micro pincers
 Pinzas finos

Micro pinzette
 Micro forceps
 Mikro Pinzetten
 Micro pincers
 Pinzas finos

1 x 2 Denti
 1 x 2 Teeth
 1 x 2 Zähne
 1 x 2 Dents
 1 x 2 Dientes

1 x 2 Denti
 1 x 2 Teeth
 1 x 2 Zähne
 1 x 2 Dents
 1 x 2 Dientes

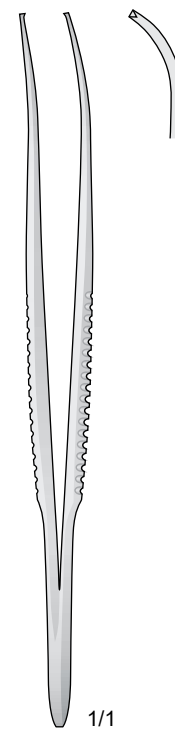
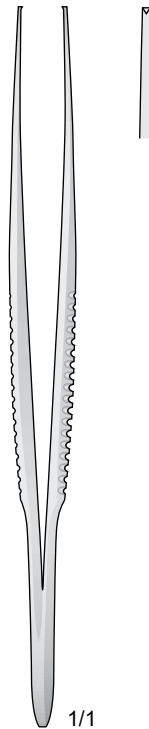
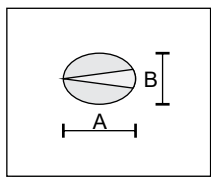

A	B		
0,4	0,25	MF 2091-01	MF 2092-01
0,5	0,35	MF 2091-02	MF 2092-02
0,7	0,55	MF 2091-03	MF 2092-03
1	0,8	MF 2091-04	MF 2092-04
1,2	0,9	MF 2091-05	MF 2092-05
		95 mm	95 mm



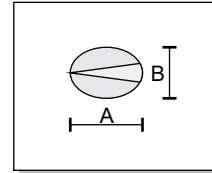

Micro pinzette
Micro forceps
Mikro Pinzetten
Micro pinces
Pinzas finos

Acuta
Sharp
Spitz
Pointu
Agudas

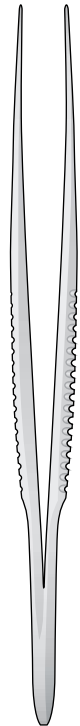

DMF 2093-09 9.5 cm

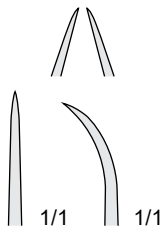

Smussa
Blunt
Stumpf
Mousse
Romos

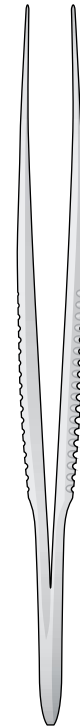

DMF 2094-09 9.5 cm

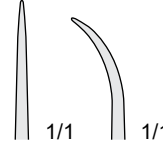

1 x 2 Denti
1 x 2 Teeth
1 x 2 Zähne
1 x 2 Dents
1 x 2 Dientes

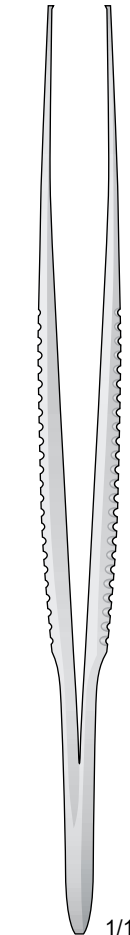

1/1

1 x 2 Denti
1 x 2 Teeth
1 x 2 Zähne
1 x 2 Dents
1 x 2 Dientes

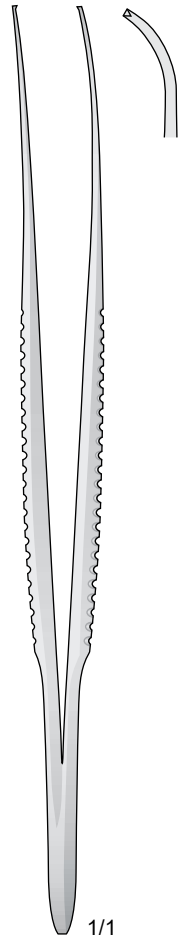

1/1

A	B		
0,4	0,25	DMF 2095-01	DMF 2096-01
0,5	0,35	DMF 2095-02	DMF 2096-02
0,7	0,55	DMF 2095-03	DMF 2096-03
1	0,8	DMF 2095-04	DMF 2096-04
1,2	0,9	DMF 2095-05	DMF 2096-05
		125 mm	125 mm

Micro Pinzette
 Micro Forceps
 Mikro Pinzetten
 Micro pincers
 Pinzas finas

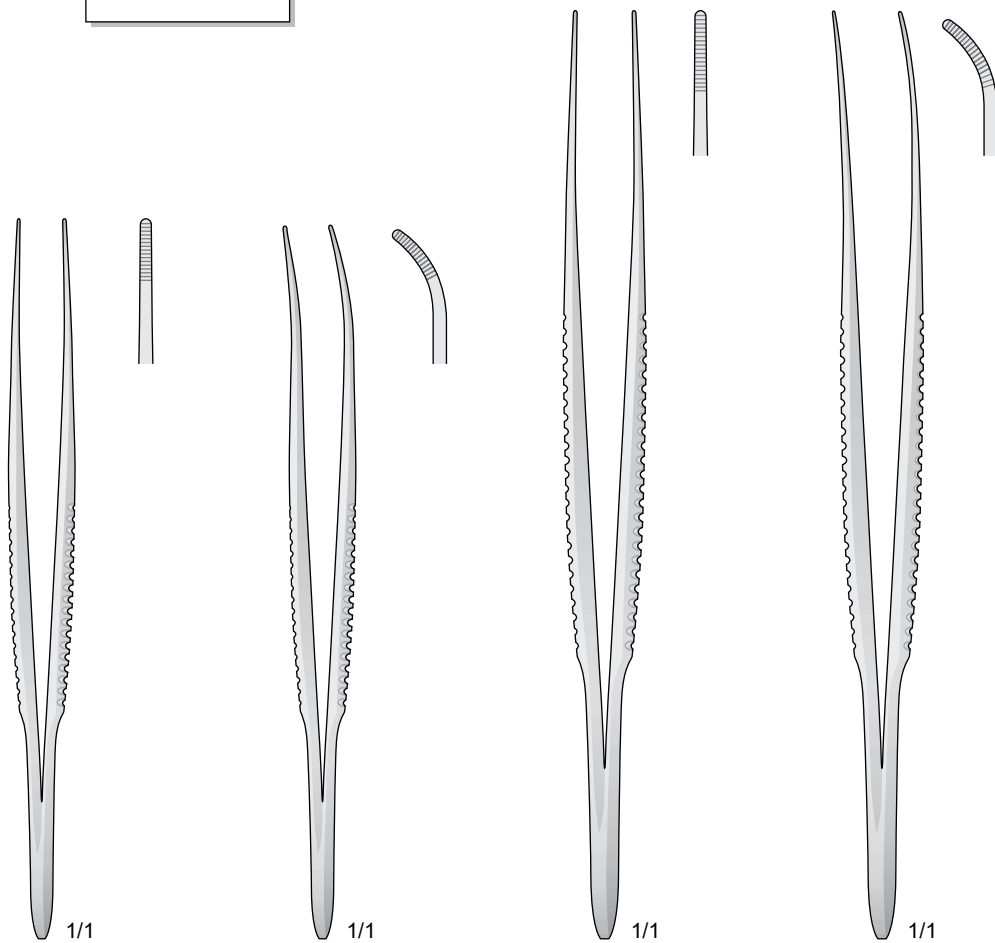
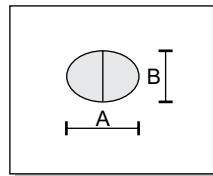

A	B				
0,5	0,4	MF 2097-01	MF 2098-01	MF 2099-01	MF 2100-01
0,6	0,5	MF 2097-02	MF 2098-02	MF 2099-02	MF 2100-02
0,9	0,7	MF 2097-03	MF 2098-03	MF 2099-03	MF 2100-03
1,3	1	MF 2097-04	MF 2098-04	MF 2099-04	MF 2100-04
1,6	1,3	MF 2097-05	MF 2098-05	MF 2099-05	MF 2100-05
		95 mm	95 mm	125 mm	125 mm



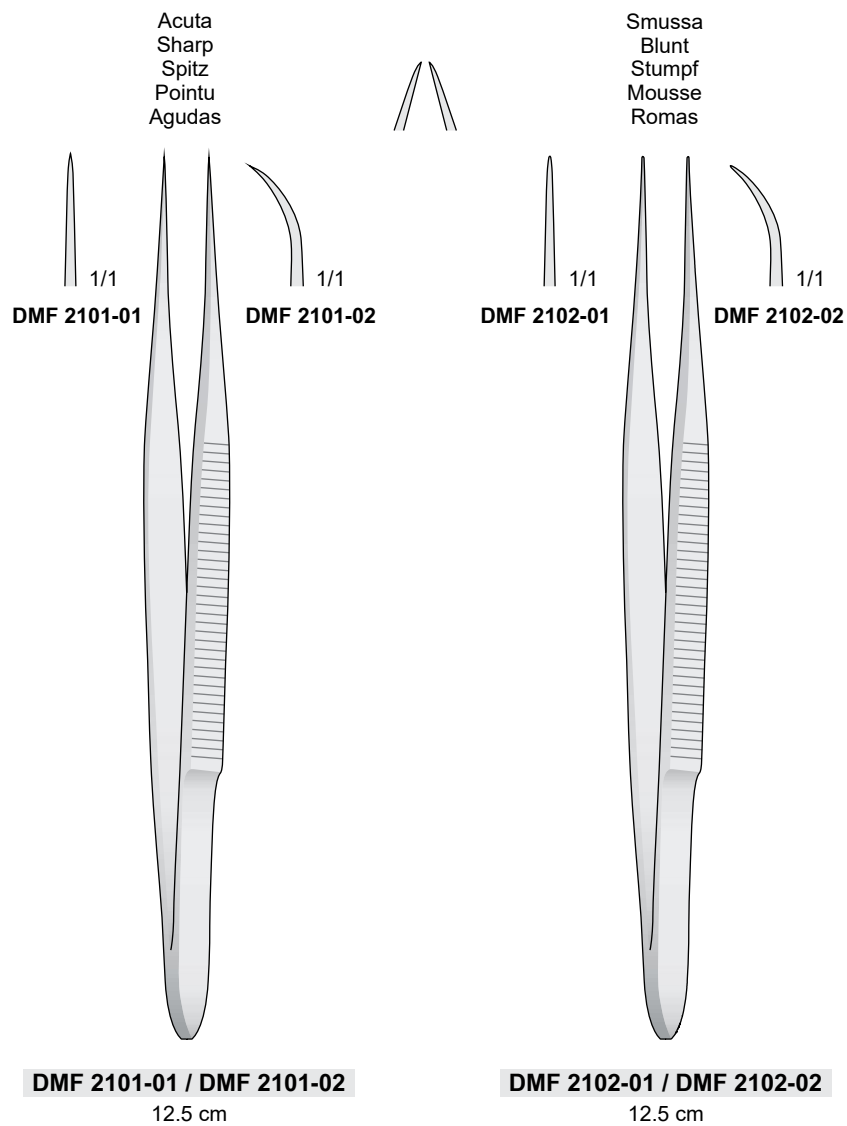

Acuta
 Sharp
 Spitz
 Pointu
 Agudas

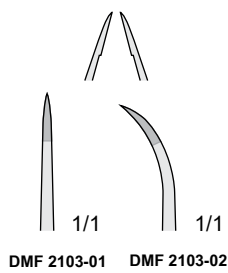
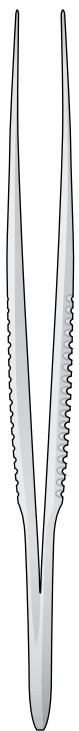

DMF 2103-01 / DMF 2103-02

9.5 cm

Smussa
 Blunt
 Stumpf
 Mousse
 Romas

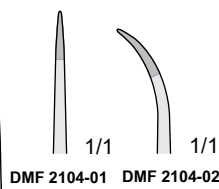
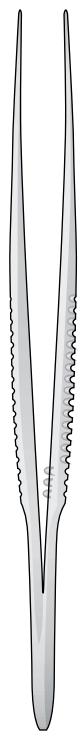

DMF 2104-01 / DMF 2104-02

9.5 cm

Acuta
 Sharp
 Spitz
 Pointu
 Agudas

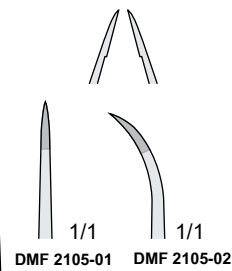
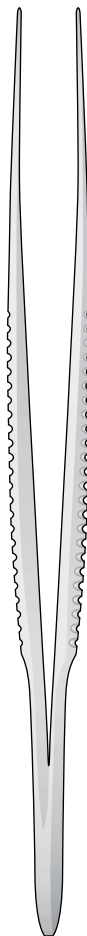

DMF 2105-01 / DMF 2105-02

12.5 cm

Smussa
 Blunt
 Stumpf
 Mousse
 Romas

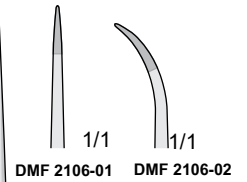
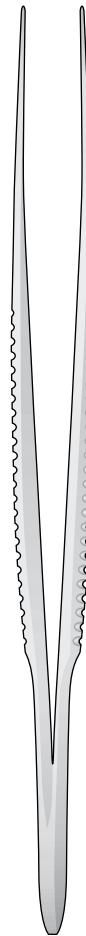

DMF 2106-01 / DMF 2106-02

12.5 cm

Set microchirurgia oftalmica

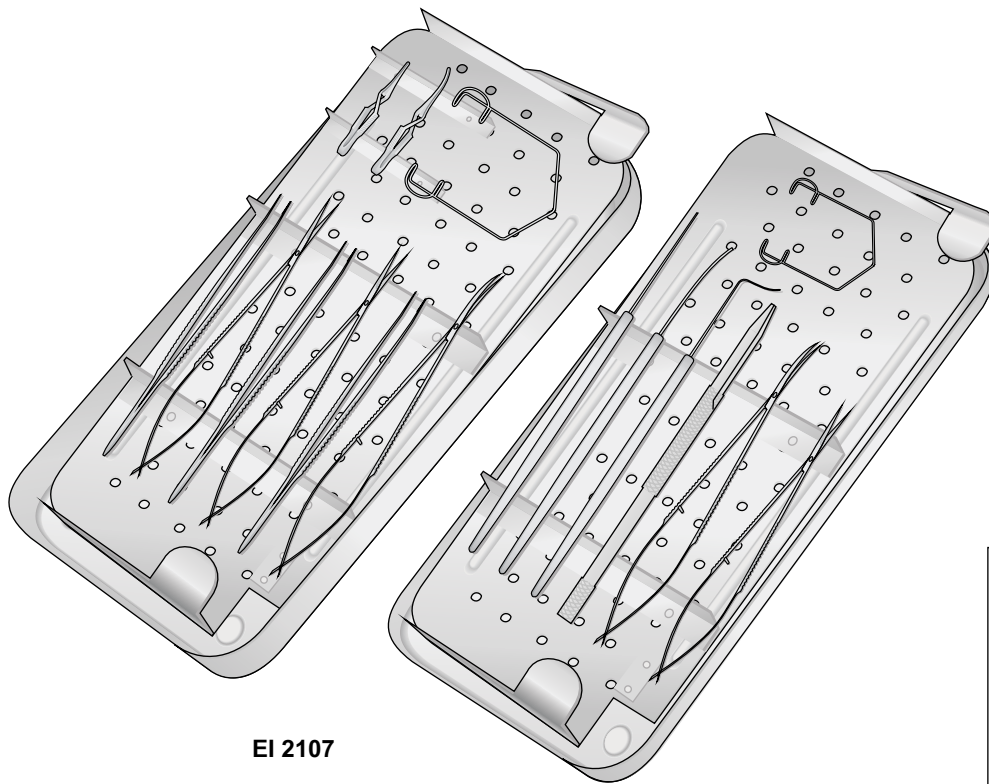

EI 2107

EI 2107
Consisting

- Bulldog diritta cm. 4
- Bulldog diritta cm. 4,5
- Micro forbice curva cm. 11
- Micro forbice curva cm. 12
- Micro pinzetta diritta cm. 11
- Micro pinzetta curva cm. 11
- Micro pinzetta 1x2 denti cm. 11
- Micro pinzetta diritta cm. 9,5
- Micro pinzetta diritta cm. 9,5
- Porta lame per micro cm. 12
- Micro bisturi Graefe cm. 13
- Micro divar. Castrovejo cm. 13
- Micro spatole Wecker cm. 13
- Micro pinzetta Colibri cm. 8
- Blefarostato Barraquer mm. 27x5



EI 2108

EI 2108
Consisting

- Micro divar. Gillies # 2
- Curette Day cm. 16
- Micro forbice curva cm. 16
- Micro forbice diritta cm. 16
- Micro port'aghi dir. cm. 15
- Micro port'aghi curvo cm. 15
- Micro pinzetta 1x2 denti cm. 15
- Micro pinzetta 1x2 denti cm. 15
- Micro pinzetta diritta cm. 15
- Micro pinzetta curva cm. 15

Set microchirurgia oftalmica

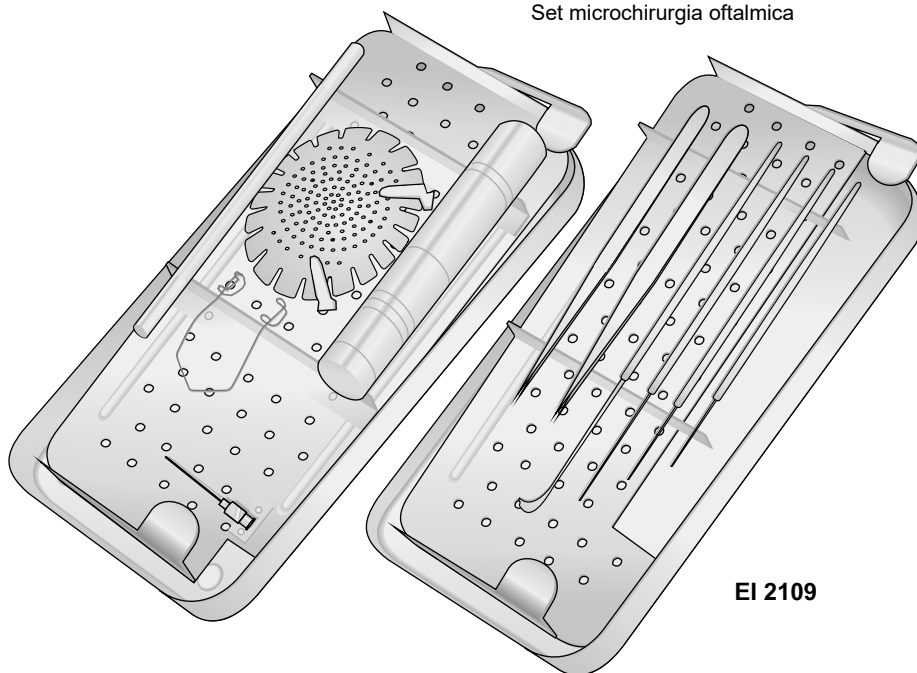

EI 2109

EI 2109
 Consisting

- Micro pinzetta cm. 12
- Div. Desmarres mm. 10
- Micro pinzetta cm. 8,5
- Bisturi Ellis cm. 12
- Spatola Kimura cm. 15
- Blefarostato Barraquer mm.27
- Dilatatore Wilder #1
- Pseudo sfera piombo
- Occlusore alluminio mm. 75

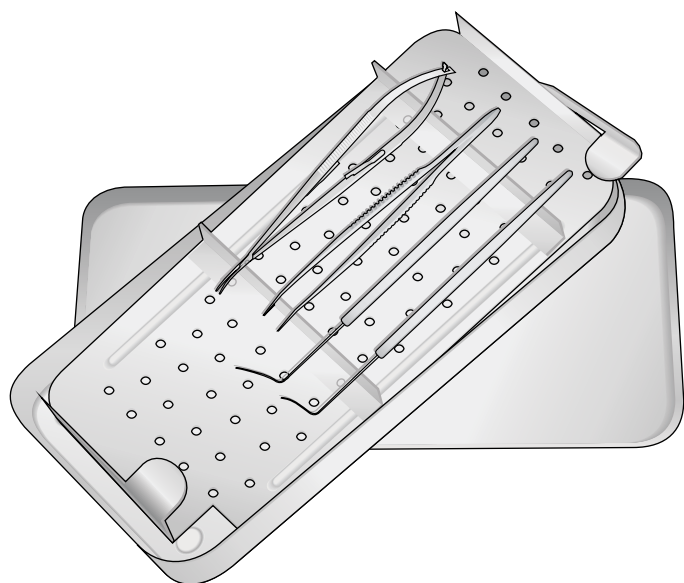

EI 2110

EI 2110
 Consisting

- Micro pinzetta cm. 12
- Micro pinzetta cm. 11
- Micro divaricatore mm. 0,2
- Uncino angolato cm. 13

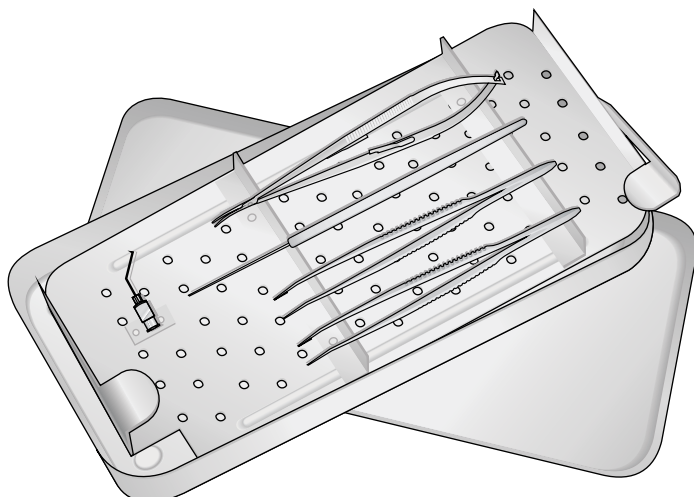

EI 2111

EI 2111
 Consisting

- Micro pinzetta 1x2 denti cm. 9,5
- Micro pinzetta McPerson cm. 9,5
- Micro pinzetta cristallino cm. 11
- Micro spatola mm. 0,2
- Ago lacrimale curvo mm. 35

Set microchirurgia oftalmica

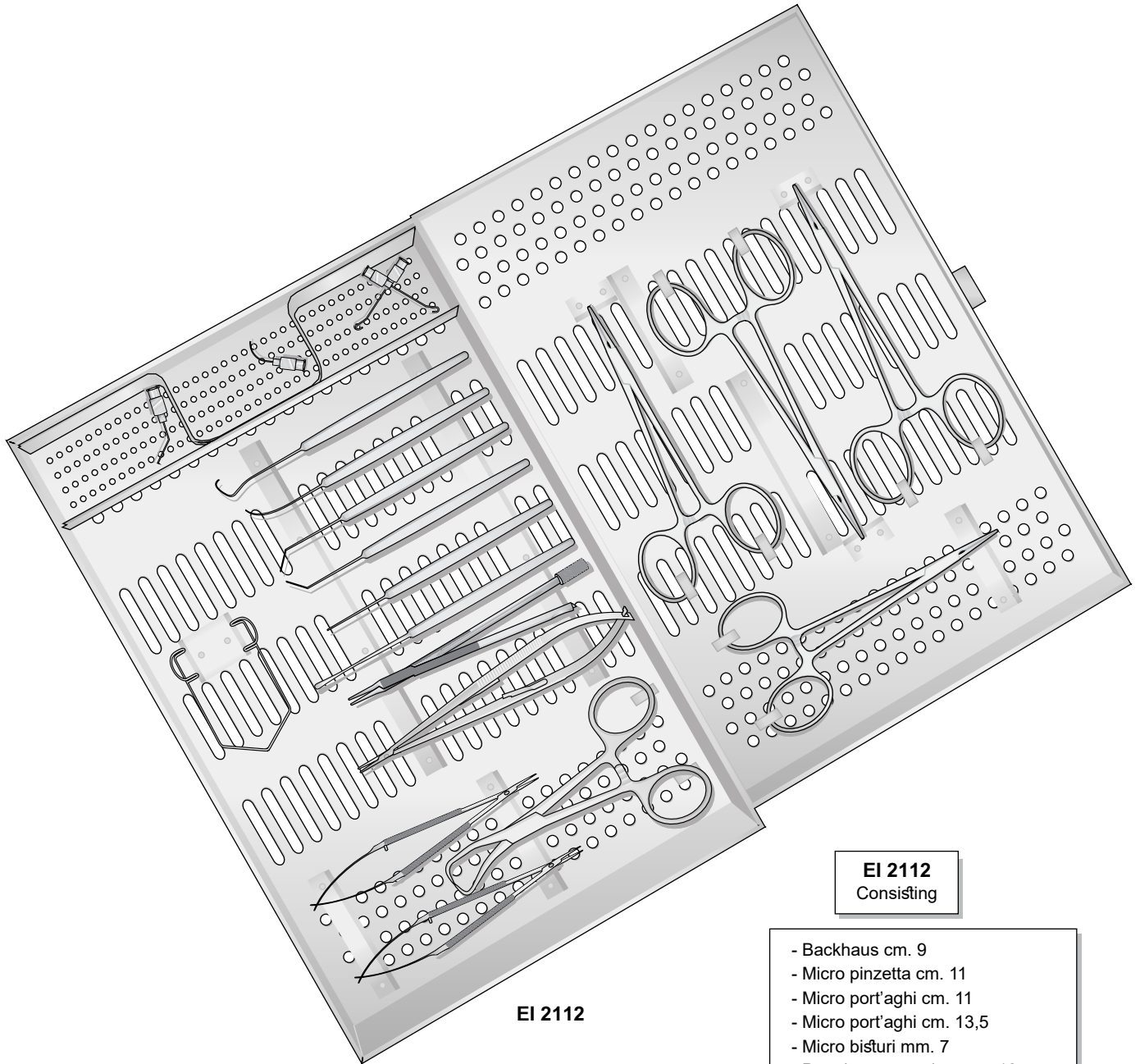

EI 2112

EI 2112
Consisting

- Backhaus cm. 9
- Micro pinzetta cm. 11
- Micro port'aghi cm. 11
- Micro port'aghi cm. 13,5
- Micro bisturi mm. 7
- Portalame per micro cm. 12
- Micro divaricatore Snellen cm. 12
- Uncino Arruga cm. 14
- Blefarostato Barraquer mm. 42x12
- Micro spatola mm. 0,2
- Micro spatola mm. 0,6
- Micro spatola mm. 1
- Ago lacrimale curvo mm. 30
- Ago lacrimale 15° Sx.
- Ago lacrimale 15° Dx.
- Ago lacrimale curvo mm. 35
- Halstead diritta cm. 12,5
- Pinza Anat. Diritta cm. 14

Set microchirurgia oftalmica

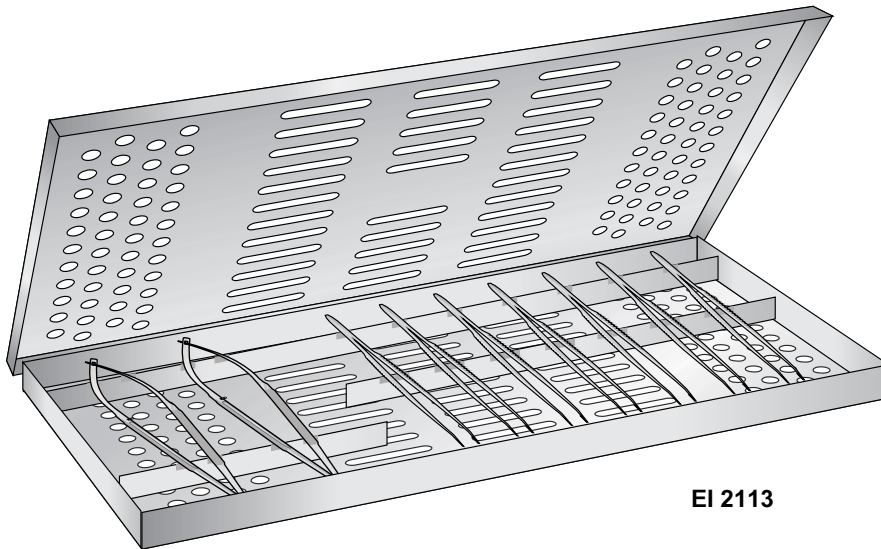

EI 2113

EI 2113
Consisting

- Micro pinzetta 1x2 denti cm. 9,5
- Micro pinzetta McPherson cm. 9,5
- Micro pinzetta cristallino cm. 11
- Micro pinzetta angolata cm. 11
- Micro pinzetta 1x2 denti cm. 9,5
- Micro pinzetta 1x2 denti cm. 9,5
- Micro pinzetta diritta cm. 9,5
- Micro pinzetta curva cm. 9,5
- Micro pinzetta Colibri cm. 9,5

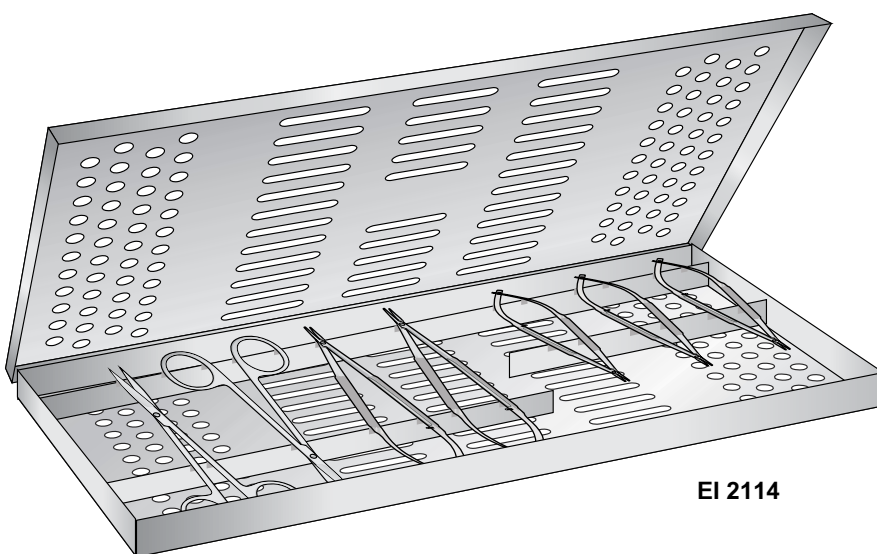

EI 2114

EI 2114
Consisting

- Micro forbice Troutmann dx. cm. 11
- Micro forbice Troutmann sx. cm. 11
- Micro forbice Vannas cm. 8,5
- Micro forbice Vannas cm. 8,5
- Micro forbice Vannas cm. 8,5
- Forbice Iris diritta cm. 11
- Forbice Iris curva cm. 11



we take a closer look

Gynecology Urology

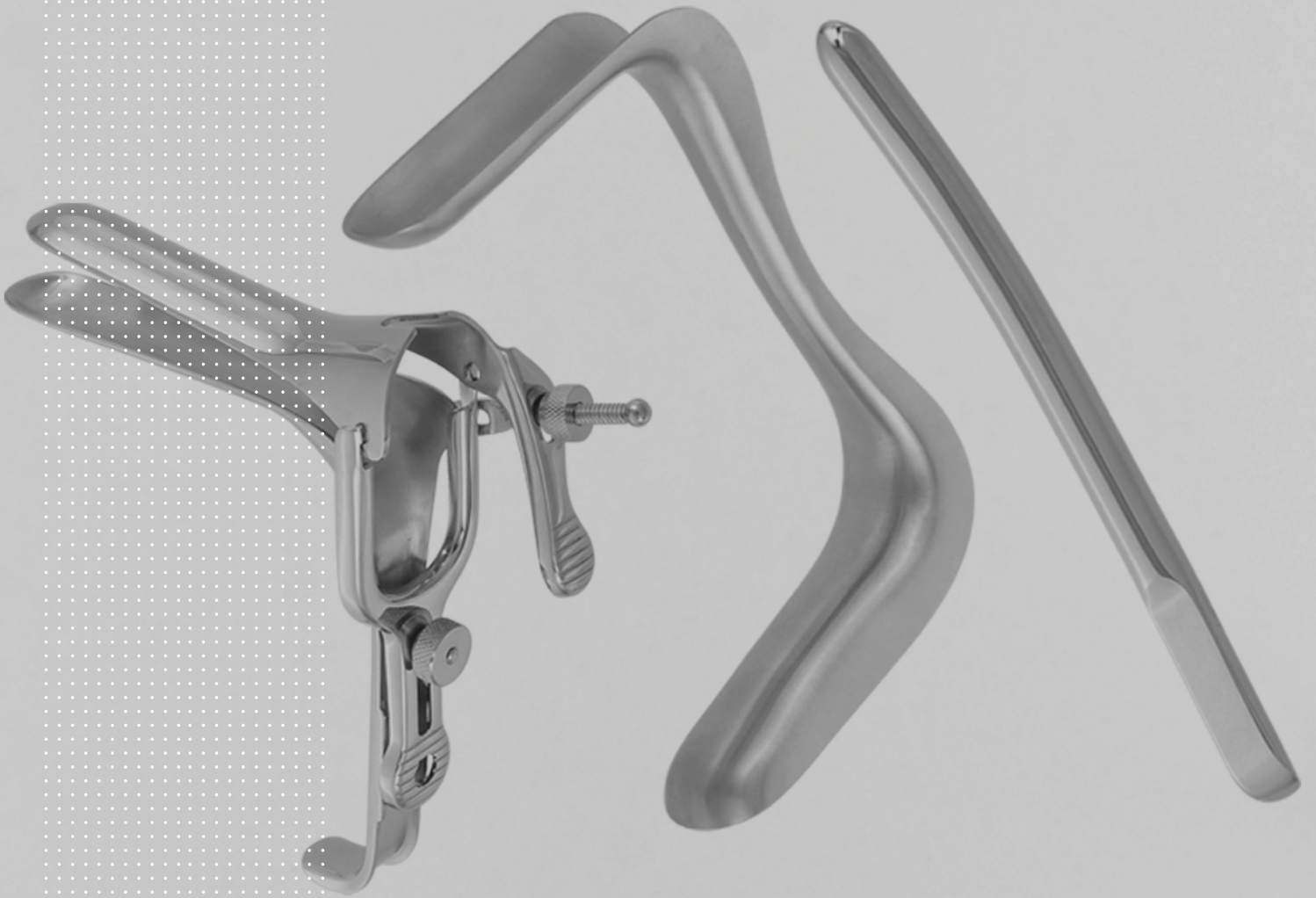

Gynäkologie | Urologie
Gynécologie | Urologie
Ginecología | Urología
Ginecologia | Urologia

Pinze per calcoli renali
 Kidney stone forceps
 Nierensteinzangen
 Pincés pour les calculs renaux
 Pinzas para cálculos renales

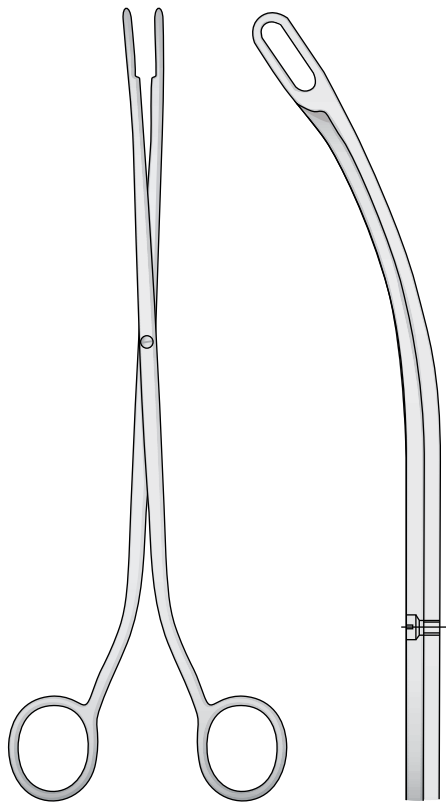

DESJARDINS
GYN 2120-01 / GYN 2120-04
 22.5 cm

Fig. 1



GYN 2120-01

Fig. 3



GYN 2120-03

Fig. 2



GYN 2120-02

Fig. 4



GYN 2120-04

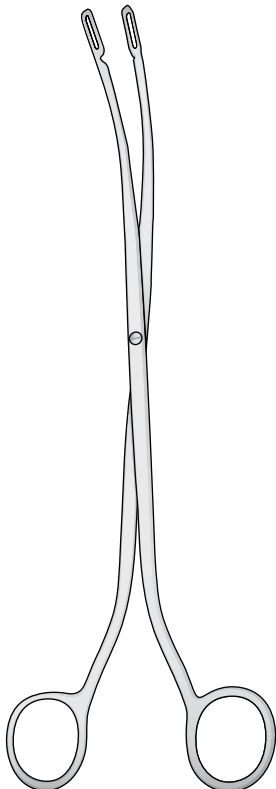

RANDALL
GYN 2121-01 / GYN 2121-04
 22.5 cm

Fig. 1

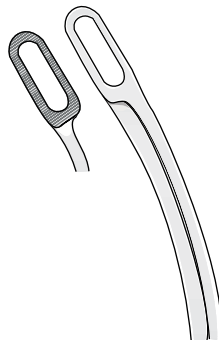

GYN 2121-01

Fig. 3

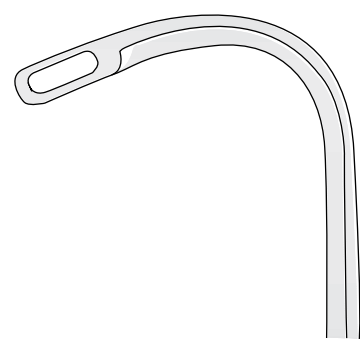

GYN 2121-03

Fig. 2

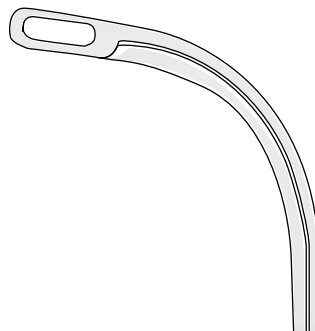

GYN 2121-02

Fig. 4

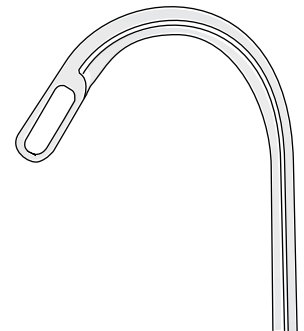

GYN 2121-04

Per uomini
For men
Für Männer
Pour hommes
Para hombres

Code	Charr.
GYN 2122-01	8
GYN 2122-02	10
GYN 2122-03	12
GYN 2122-04	14
GYN 2122-05	16
GYN 2122-06	18
GYN 2122-07	20

Ø 2,7 mm

Ø 3 mm

Per donne
For woman
Für Frauen
Pour femmes
Para mujeres

Code	Charr.
GYN 2123-01	6
GYN 2123-02	8
GYN 2123-03	10
GYN 2123-04	12
GYN 2123-05	14
GYN 2123-06	16
GYN 2123-07	18

Ø 1,2 mm

Ø 3 mm

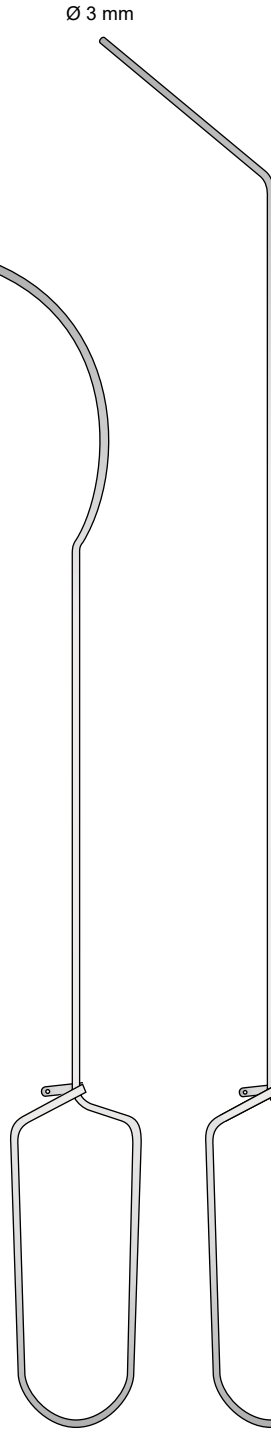
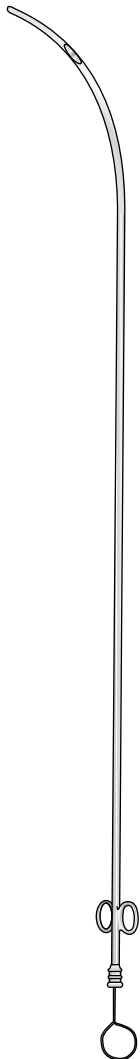

GUYON
GYN 2124-36
36.5 cm

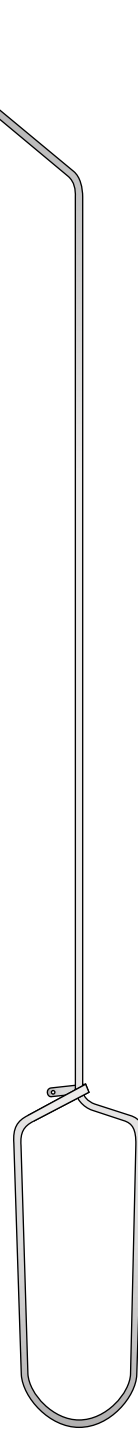

BENIQUE
GYN 2125-41
41 cm

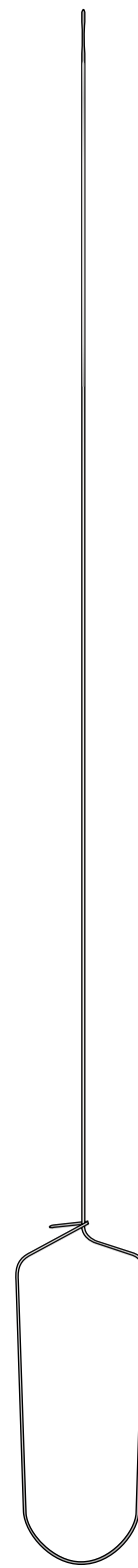

GYN 2126-46
46 cm

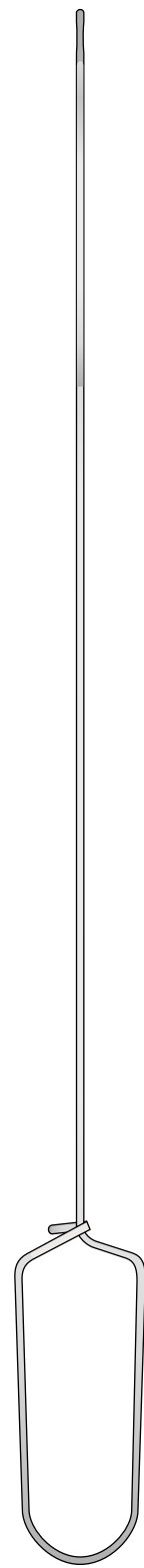

GYN 2127-46
46 cm

GYN 2122-01 / GYN 2122-07

29 cm

GYN 2123-01 / GYN 2123-07

16 cm

Dilatatori per vie biliari
 Gall duct dilators
 Gallengang dilatatoren
 Dilatateurs pour les voies biliaires
 Dilatadores para conductos biliares

Code	Size
GYN 2128-01	190 mm - Ø 3 mm
GYN 2128-02	190 mm - Ø 4 mm
GYN 2128-03	190 mm - Ø 5 mm
GYN 2128-04	190 mm - Ø 6 mm
GYN 2128-05	190 mm - Ø 7 mm
GYN 2128-06	190 mm - Ø 8 mm
GYN 2128-07	190 mm - Ø 9 mm
GYN 2128-08	190 mm - Ø 10 mm
GYN 2128-09	190 mm - Ø 11 mm

Code	Size
GYN 2129-01	300 mm - Ø 1 mm
GYN 2129-02	300 mm - Ø 2 mm
GYN 2129-03	300 mm - Ø 3 mm
GYN 2129-04	300 mm - Ø 4 mm
GYN 2129-05	300 mm - Ø 5 mm
GYN 2129-06	300 mm - Ø 6 mm
GYN 2129-07	300 mm - Ø 7 mm
GYN 2129-08	300 mm - Ø 8 mm
GYN 2129-09	300 mm - Ø 9 mm
GYN 2129-10	300 mm - Ø 10 mm
GYN 2129-11	300 mm - Ø 11 mm
GYN 2129-12	300 mm - Ø 12 mm
GYN 2129-13	300 mm - Ø 13 mm

GYN 2130
 Set completo di 9 pezzi
 con custodia

GYN 2131
 Set completo di
 13 pezzi

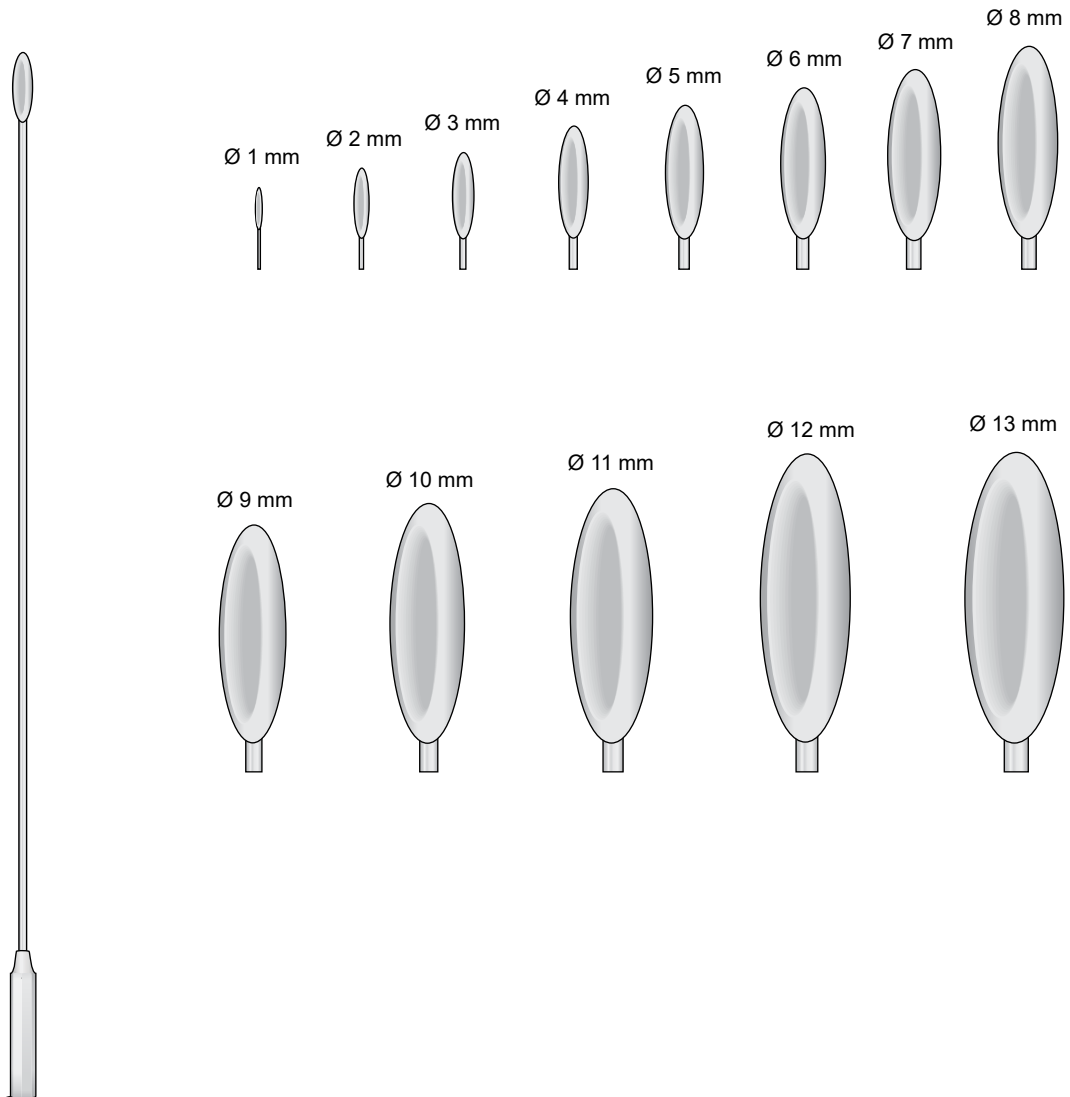

BAKES

GYN 2128-01 / GYN 2129-13





Code	Charr.
GYN 2132-01	8
GYN 2132-02	9
GYN 2132-03	10
GYN 2132-04	11
GYN 2132-05	12
GYN 2132-06	14
GYN 2132-07	16
GYN 2132-08	18
GYN 2132-09	20
GYN 2132-10	22
GYN 2132-11	24
GYN 2132-12	25
GYN 2132-13	26
GYN 2132-14	27
GYN 2132-15	28
GYN 2132-16	29
GYN 2132-17	30

DITTEL

GYN 2132-01 / GYN 2132-17

22 cm

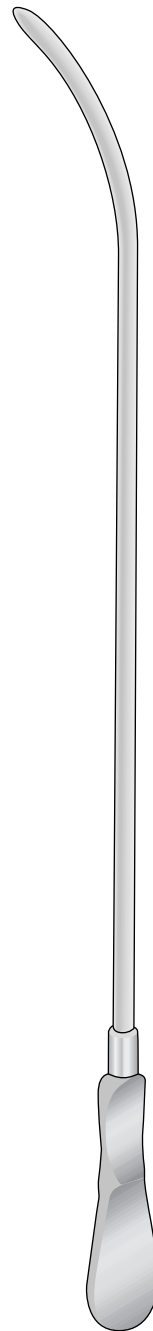

Code	Charr.
GYN 2133-01	8
GYN 2133-02	9
GYN 2133-03	10
GYN 2133-04	11
GYN 2133-05	12
GYN 2133-06	13
GYN 2133-07	14
GYN 2133-08	15
GYN 2133-09	16
GYN 2133-10	17
GYN 2133-11	18
GYN 2133-12	19
GYN 2133-13	20
GYN 2133-14	21
GYN 2133-15	22
GYN 2133-16	23
GYN 2133-17	24
GYN 2133-18	25
GYN 2133-19	26
GYN 2133-20	27
GYN 2133-21	28
GYN 2133-22	29
GYN 2133-23	30

DITTEL

GYN 2133-01 / GYN 2133-17

34.5 cm

Dilatatori per calcoli biliari
Gall duct dilators
Gallengangdilatore
Bougies dilatatrices
Bujias dilatadoras

GYN 2134-01 - Ø 10 mm  1/1

GYN 2134-02 - Ø 9 mm  1/1

GYN 2134-03 - Ø 8 mm  1/1

GYN 2134-04 - Ø 7 mm  1/1

GYN 2134-05 - Ø 6 mm  1/1

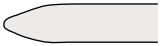
GYN 2134-06 - Ø 5 mm  1/1

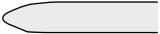
GYN 2134-07 - Ø 4 mm  1/1

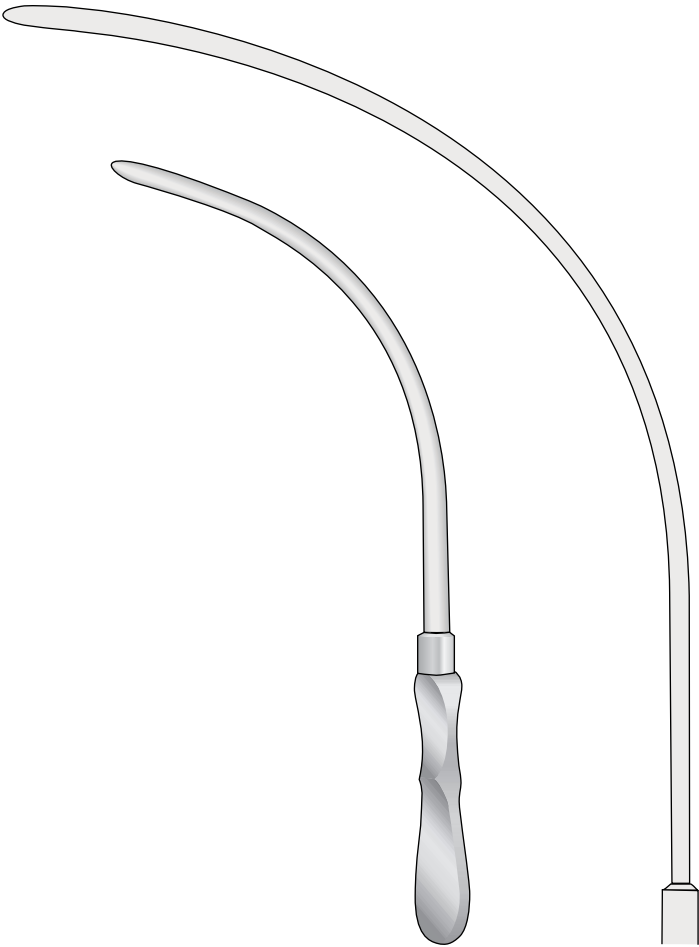
GYN 2134-08 - Ø 3 mm  1/1

GYN 2134-01 / GYN 2134-08

19 cm

Sonde per dotto biliare, Elastiche
 Gall Stone Probes, Elastic
 Gallensteinsonden, Federnd
 Explorateurs pour calculs biliaires, Élastiques
 Exploradores para cálculos biliares, Elásticos

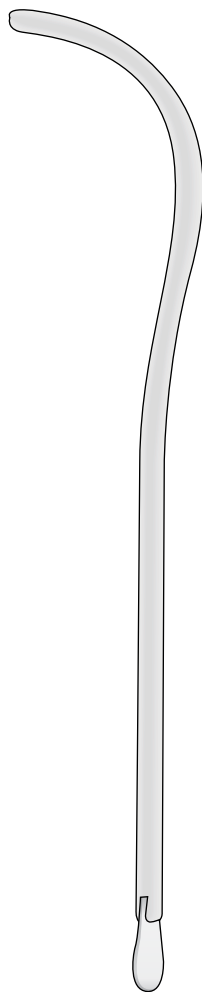

GUYON

GYN 2135-01 / GYN 2135-19

25.5 cm

Code	Ben.	Charr.
GYN 2135-01	24	12
GYN 2135-02	26	13
GYN 2135-03	28	14
GYN 2135-04	30	15
GYN 2135-05	32	16
GYN 2135-06	34	17
GYN 2135-07	36	18
GYN 2135-08	38	19
GYN 2135-09	40	20
GYN 2135-10	42	21
GYN 2135-11	44	22
GYN 2135-12	46	23
GYN 2135-13	48	24
GYN 2135-14	50	25
GYN 2135-15	52	26
GYN 2135-16	54	27
GYN 2135-17	56	28
GYN 2135-18	58	29
GYN 2135-19	60	30



DESJARDINS

GYN 2136-01 / GYN 2136-03

28 cm

Ø 4,3 mm

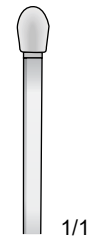

1/1

GYN 2136-01

Ø 6,0 mm



1/1

GYN 2136-02

Ø 7,0 mm



1/1

GYN 2136-03

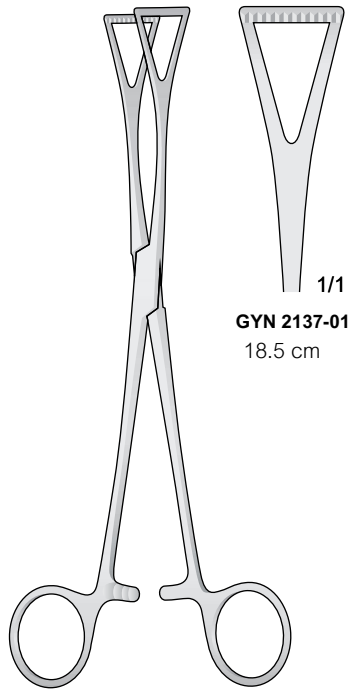

1/1
GYN 2137-01
 18.5 cm

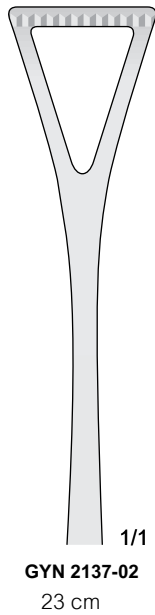

1/1
GYN 2137-02
 23 cm

DUVAL
GYN 2137-01 / GYN 2137-02

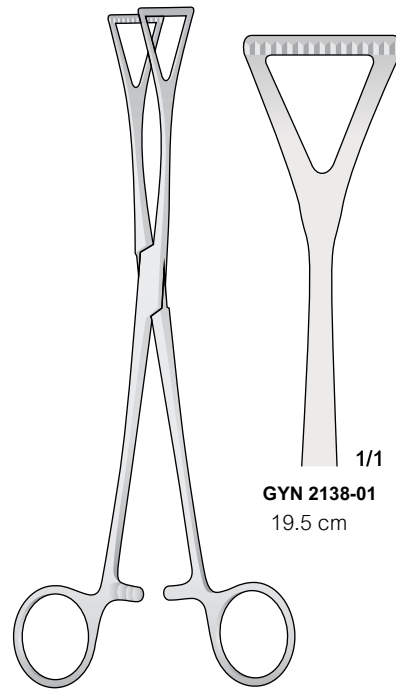

1/1
GYN 2138-01
 19.5 cm

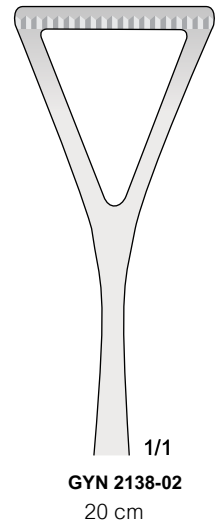

1/1
GYN 2138-02
 20 cm

DUVAL-COLLIN
GYN 2138-01 / GYN 2138-02

Pinze per peduncoli renali - Kidney pedicle clamp forceps - Nierenstielklemmen
 Pincas-clamps pour pédicules rénaux - Pinzas-clamps para pedúnculos renales

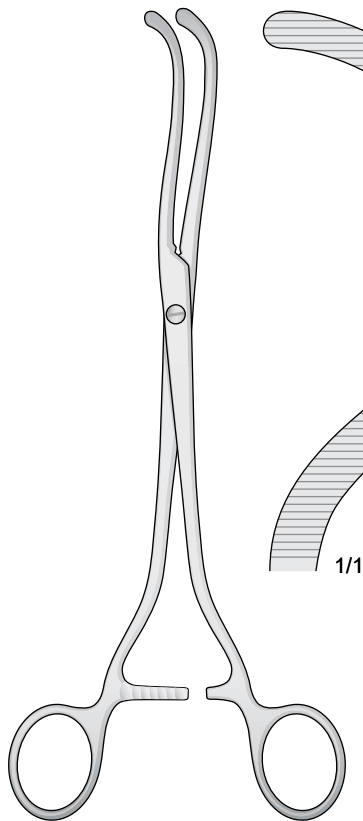

BRAUN
GYN 2139-24 24.5 cm

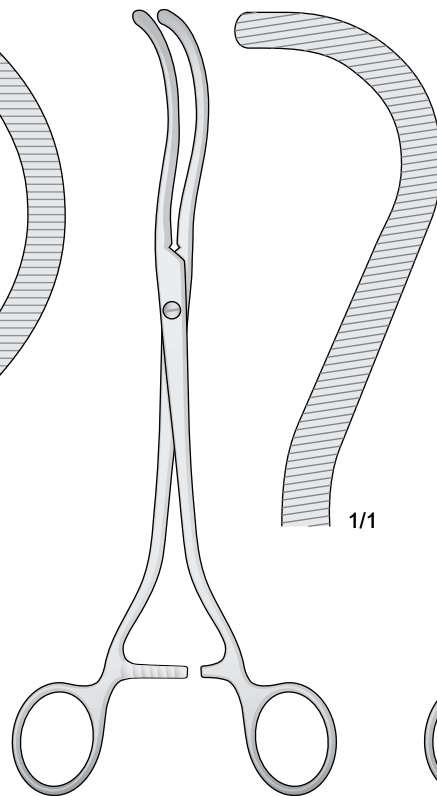

GUYON
GYN 2140-23 23.5 cm

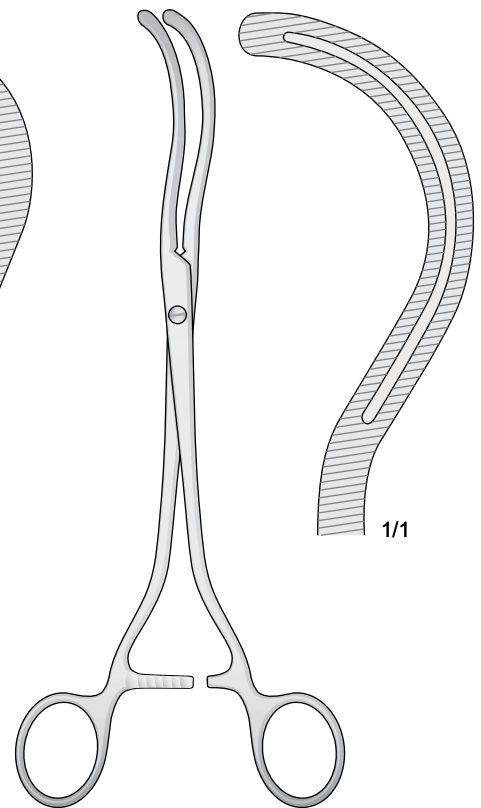

STILLE
GYN 2141-24 24 cm

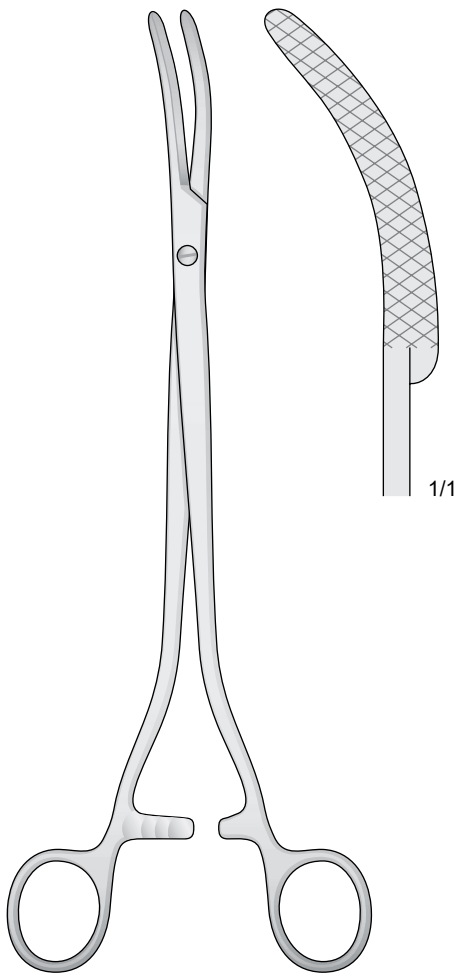

WERTHEIM
GYN 2142-26 26 cm

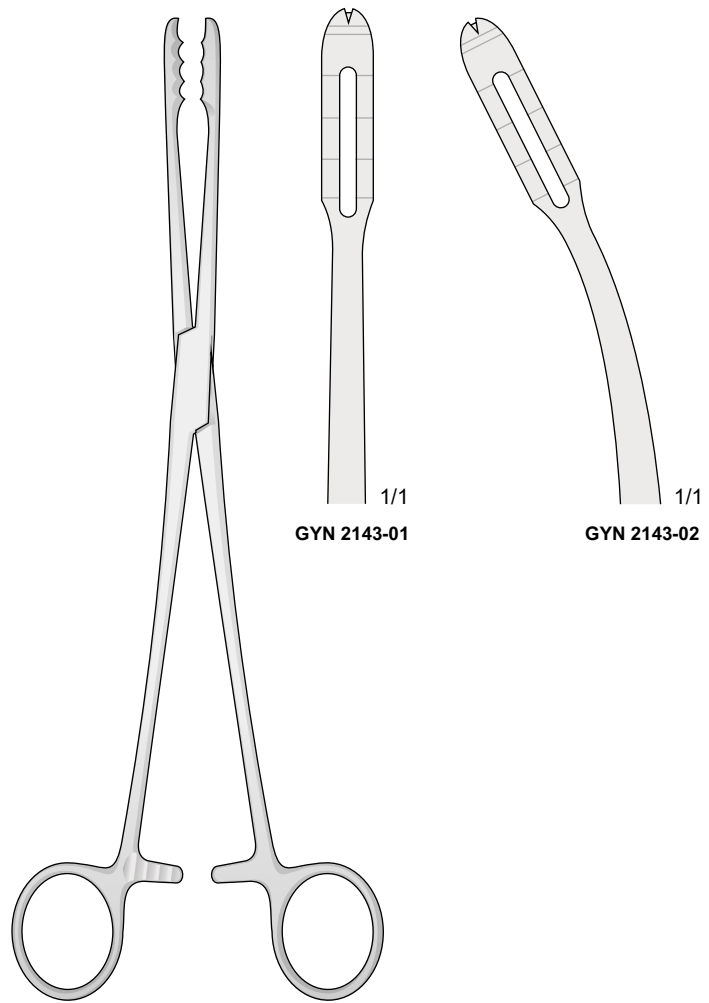

GYN 2143-01 / GYN 2143-02
26.5 cm

Pinze per peduncoli renali
Kidney pedicle forceps
Nierenklemmen
Pinces-clamps pour pédicules rénaux
Pinzas para pedúnculos renales

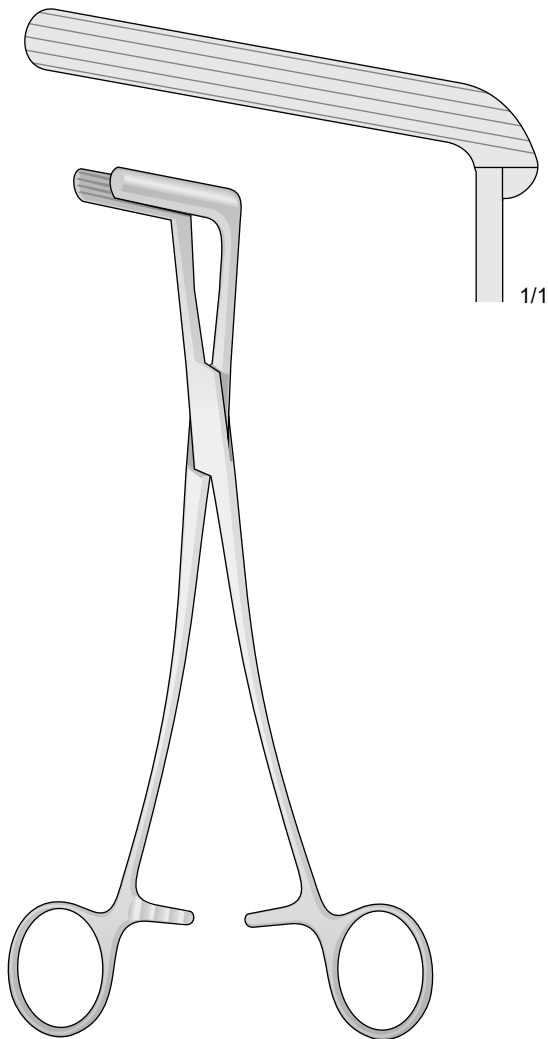

WERTHEIM
GYN 2144-23 23.5 cm

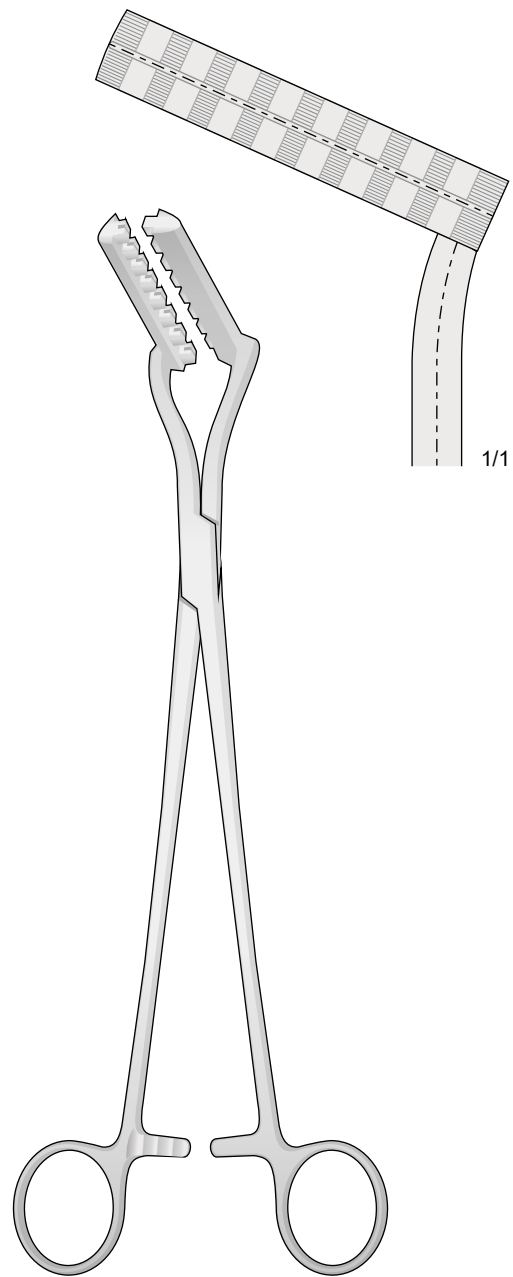

GYN 2145-28 28 cm

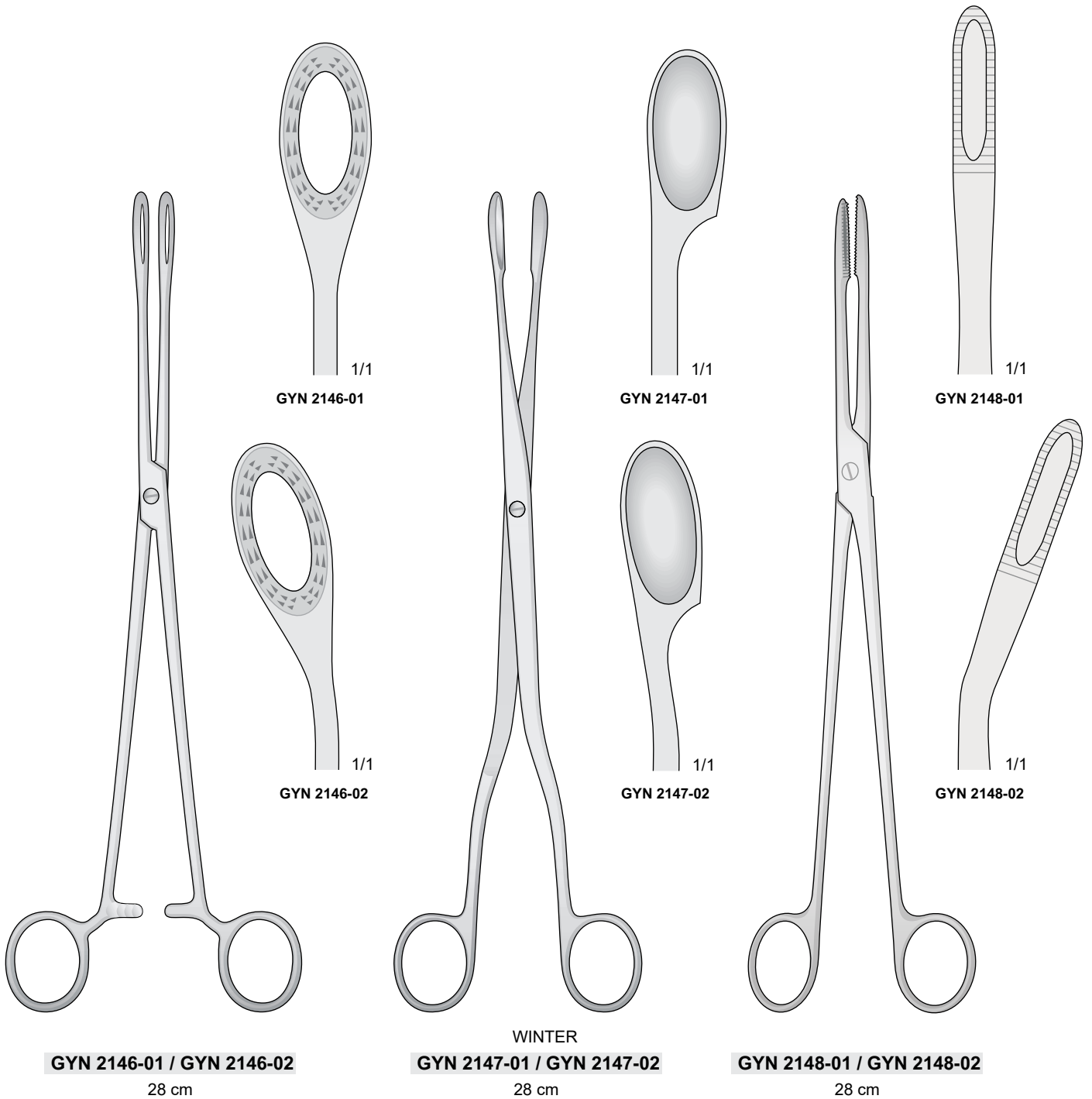

Pinze emostatic
 Artery forcep
 Arterienklemme
 Pinces hemostatique
 Pinzas hemostaticas

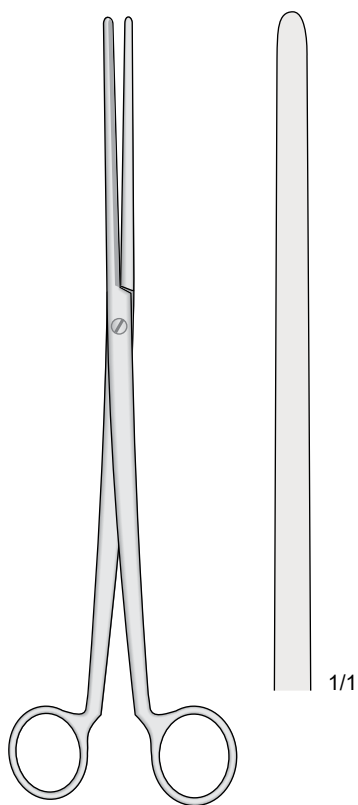

COLLIN
GYN 2149-26 26 cm

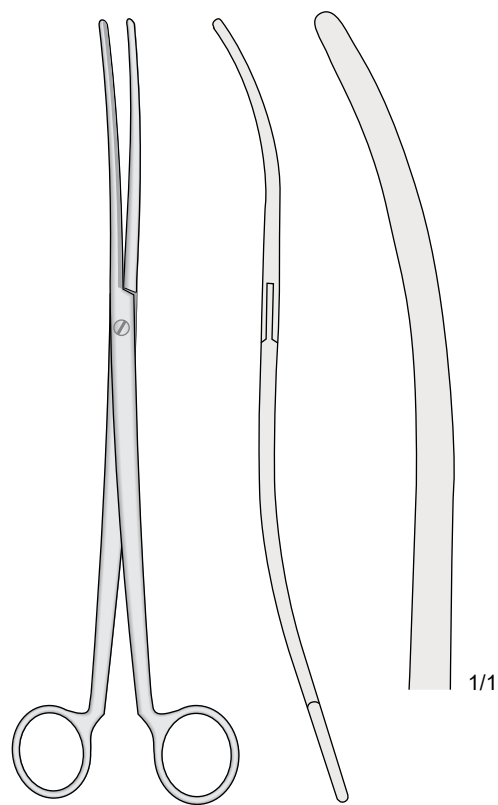

COLLIN
GYN 2150-26 26 cm

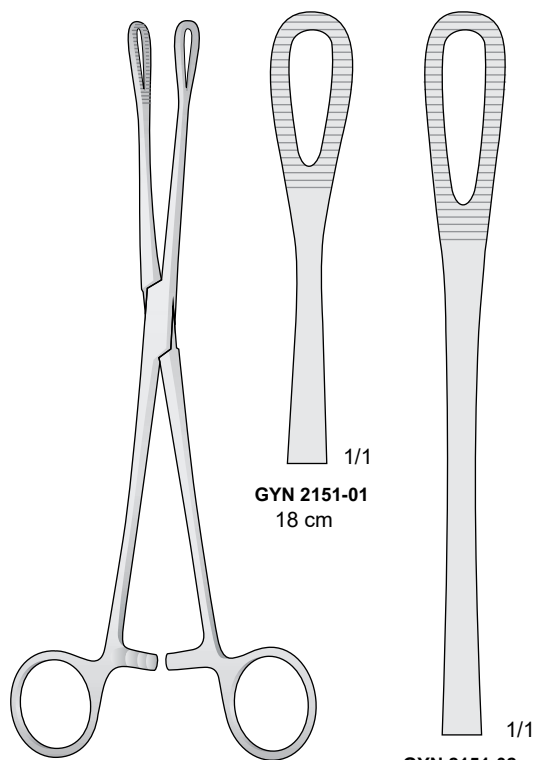

RAMPLEY
GYN 2151-01 / GYN 2151-02

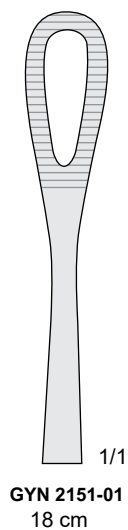

GYN 2151-01
 18 cm

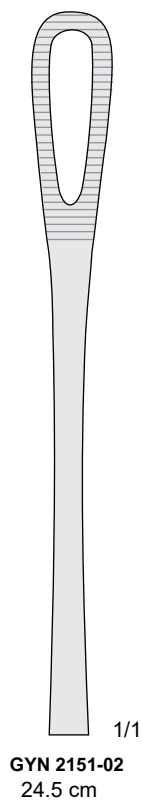

GYN 2151-02
 24.5 cm

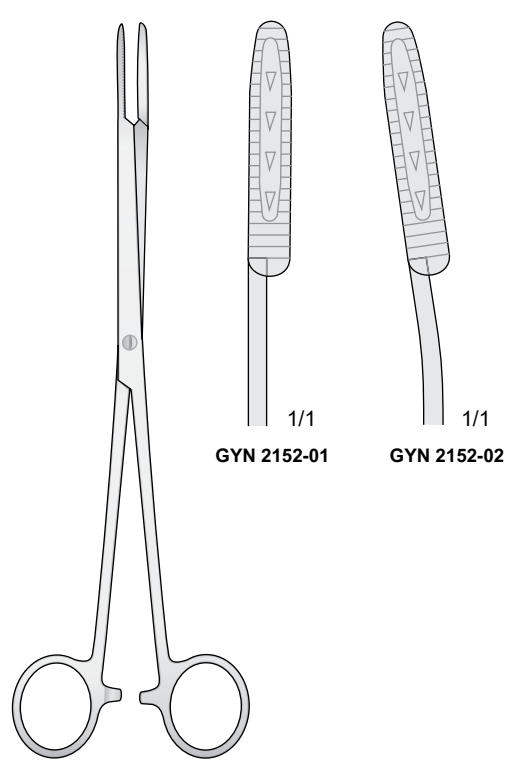

MAIER
GYN 2152-01 / GYN 2152-02
 24.5 cm

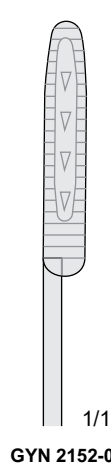

GYN 2152-01
 1/1

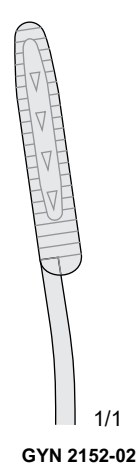

GYN 2152-02
 1/1

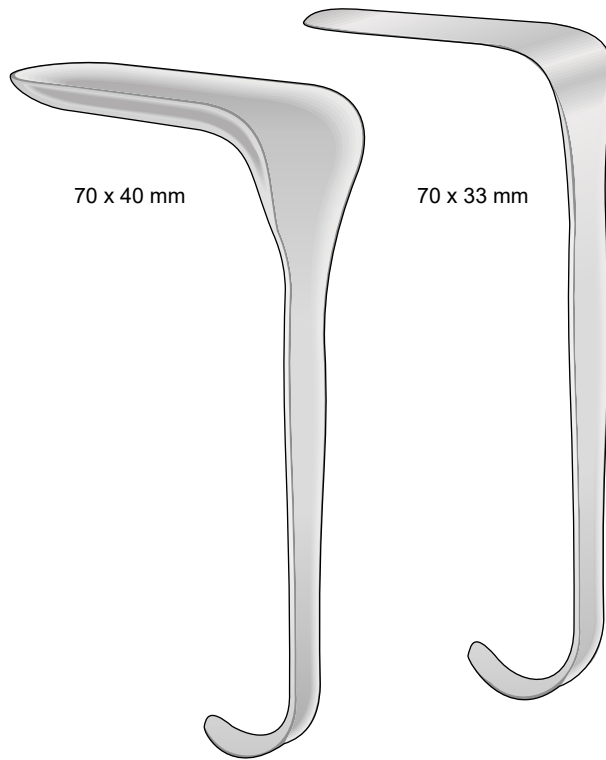

70 x 40 mm

70 x 33 mm

GYN 2155
Set 2 pezzi - Set 2 pieces
Set 2 stück - Set 2 pièces
Set 2 piezas
70 x 40 mm
70 x 33 mm

KALLMORGEN

GYN 2153-17 17 cm

GYN 2154-17 17 cm

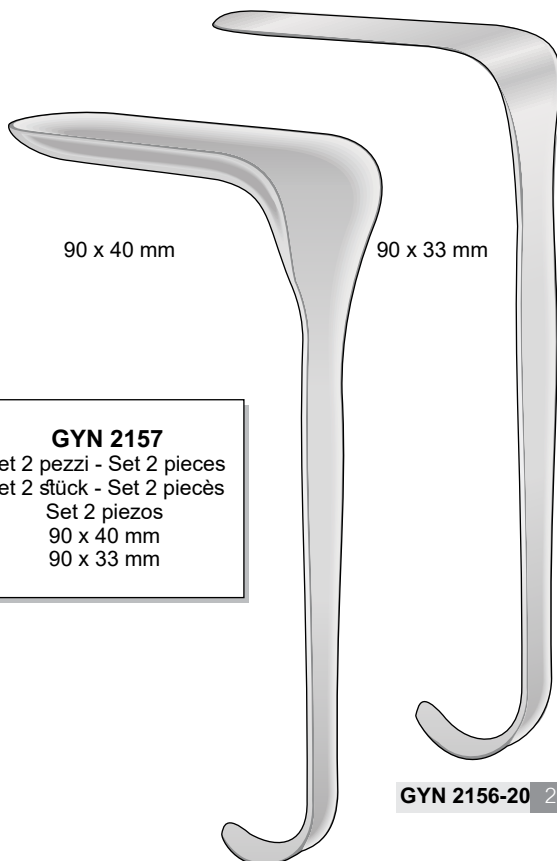

90 x 40 mm

90 x 33 mm

GYN 2157
Set 2 pezzi - Set 2 pieces
Set 2 stück - Set 2 pièces
Set 2 piezas
90 x 40 mm
90 x 33 mm

GYN 2156-20 20 cm

KALLMORGEN

GYN 2155-20 20 cm

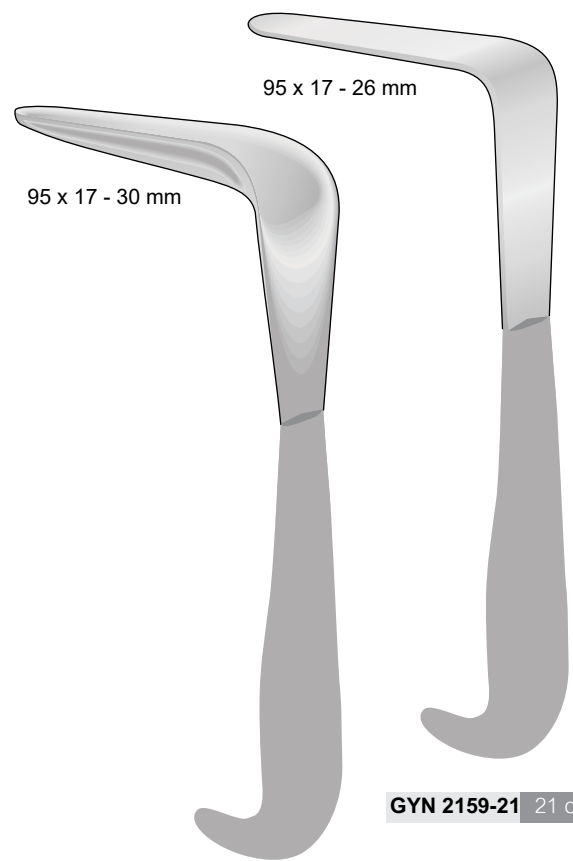

95 x 17 - 26 mm

95 x 17 - 30 mm

GYN 2159-21 21 cm

MATHIEU

GYN 2158-21 21 cm

Speculum vaginali
 Vaginal specul
 Scheidenspekul
 Spéculums vaginaux
 Espéculos vaginales

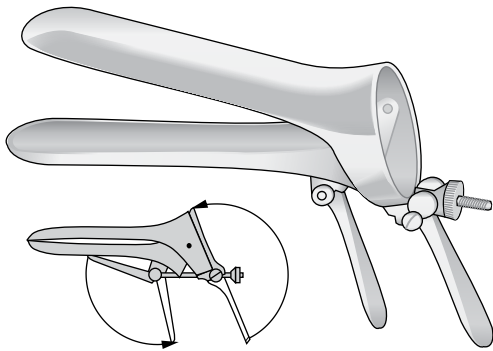

CUSCO

Code	Size
GYN 2160-01	Fig. 0 77x17 mm
GYN 2160-02	Fig. 1 75x33 mm
GYN 2160-03	Fig. 2 86x36 mm
GYN 2160-04	Fig. 3 97x36 mm

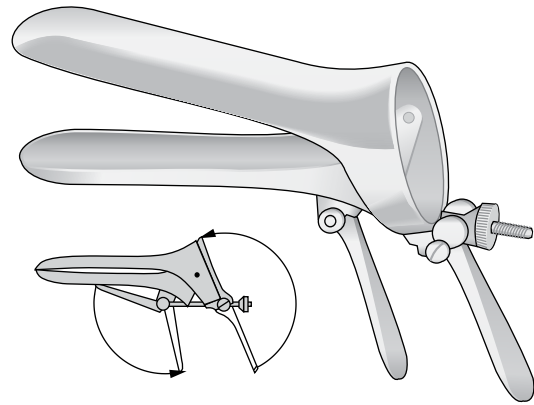

CUSCO
 SCHWEIZER MODELL

Code	Size
GYN 2161-01	Fig.1 90x23 mm
GYN 2161-02	Fig.2 100x24 mm
GYN 2161-03	Fig.3 105x27 mm

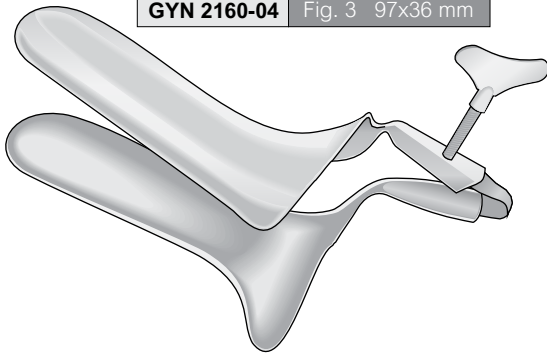

COLLIN-STANDARD

Code	Size
GYN 2162-01	Fig. 1 90x29 mm
GYN 2162-02	Fig. 2 95x35 mm
GYN 2162-03	Fig. 3 110x40 mm

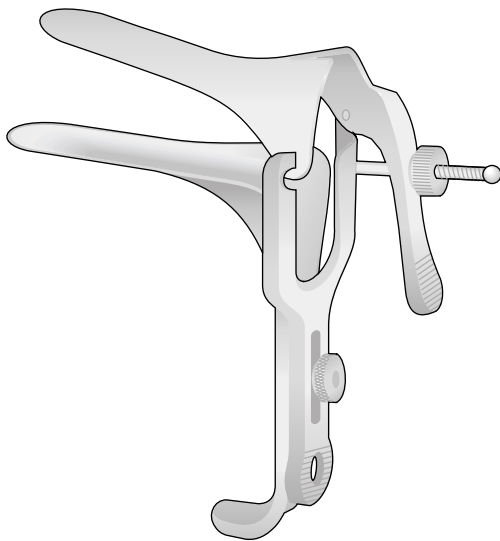

GRAVE

Code	Size
GYN 2163-01	75x20 mm
GYN 2163-02	95x30 mm
GYN 2163-03	105x33 mm

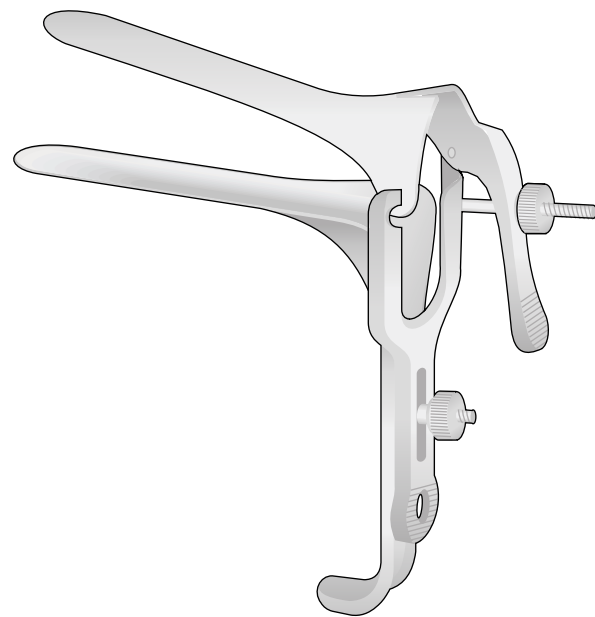

PEDERSON

Code	Size
GYN 2164-01	100x22 mm
GYN 2164-02	120x25 mm

Speculum
Spekula
Specula
Spéculum
Espéculos

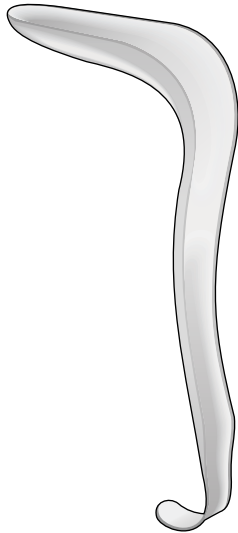

KRISTELLER

Code	Size
GYN 2165-01	Fig.1 70 x 27 mm
GYN 2165-02	Fig.2 75 x 30 mm
GYN 2165-03	Fig.3 90 x 36 mm

Valva
Halter
Retractors
Valves
Valvas

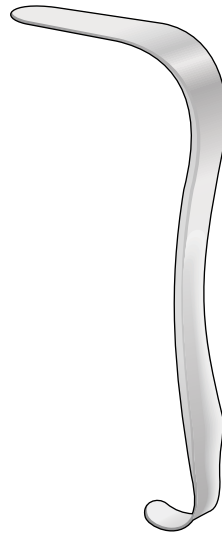

KRISTELLER

Code	Size
GYN 2166-01	Fig.1 75 x 23 mm
GYN 2166-02	Fig.2 80 x 26 mm
GYN 2166-03	Fig.3 95 x 32 mm

Speculum + Valva
Specula + Retractor
Spekula + Halter
Spéculum + Valve
Espéculo + Valva

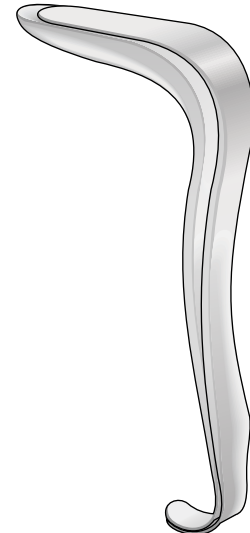

Code	Size
GYN 2167-01	Fig.1
GYN 2167-02	Fig.2
GYN 2167-03	Fig.3

Speculum
Spekula
Specula
Spéculum
Espéculos



KRISTELLER

Code	Size
GYN 2168-01	Fig.00 110 x 18 mm
GYN 2168-02	Fig.0 110 x 21 mm
GYN 2168-03	Fig.1 110 x 27 mm
GYN 2168-04	Fig.2 110 x 30 mm
GYN 2168-05	Fig.3 110 x 36 mm

Valva
Halter
Retractors
Valves
Valvas



KRISTELLER

Code	Size
GYN 2169-01	Fig.00 115 x 14 mm
GYN 2169-02	Fig.0 115 x 17 mm
GYN 2169-03	Fig.1 115 x 23 mm
GYN 2169-04	Fig.2 115 x 26 mm
GYN 2169-05	Fig.3 115 x 32 mm

Speculum + Valva
Specula + Retractor
Spekula + Halter
Spéculum + Valve
Espéculo + Valva



Code	Size
GYN 2170-01	Fig.00
GYN 2170-02	Fig.0
GYN 2170-03	Fig.1
GYN 2170-04	Fig.2
GYN 2170-05	Fig.3

Speculum vaginali
 Vaginal specul
 Scheidenspekul
 Spéculums vaginaux
 Espéculos vaginales

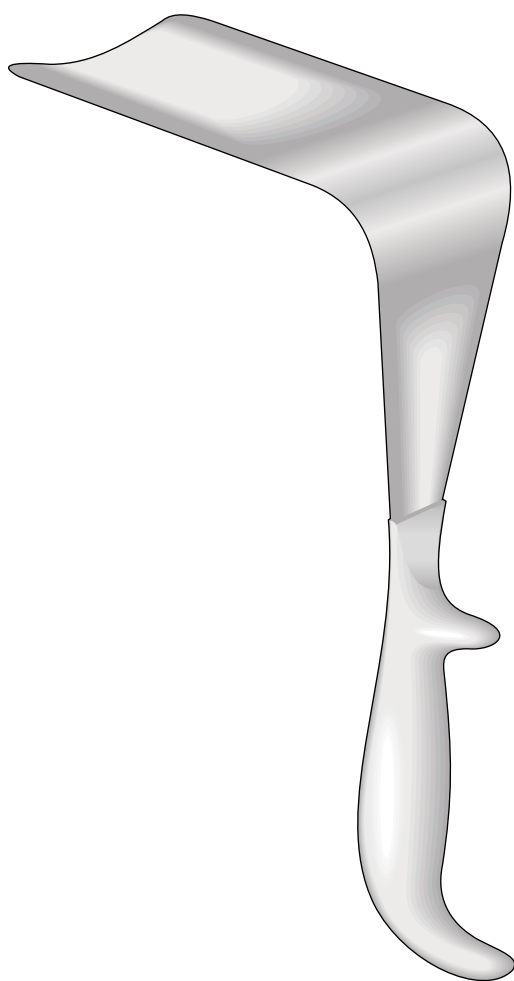

Code	Size
GYN 2171-01	Fig.1 60 x 35 mm
GYN 2171-02	Fig.2 90 x 35 mm
GYN 2171-03	Fig.3 120 x 35 mm
GYN 2171-04	Fig.1 60 x 45 mm
GYN 2171-05	Fig.2 90 x 45 mm
GYN 2171-06	Fig.3 120 x 45 mm
GYN 2171-07	Fig.4 160 x 45 mm
GYN 2171-08	Fig.1 60 x 60 mm
GYN 2171-09	Fig.2 90 x 60 mm
GYN 2171-10	Fig.3 120 x 60 mm
GYN 2171-11	Fig.4 160 x 60 mm

DOYEN
GYN 2171-01 / GYN 2171-11
 24 cm



Code	Size
GYN 2172-01	100 x 28 mm
GYN 2172-02	100 x 38 mm

LANDAU
GYN 2172-01 / GYN 2172-02
 29 cm



BREISKY 29 cm

Code	Size
GYN 2173-01	100 x 20 mm
GYN 2173-02	100 x 25 mm
GYN 2173-03	100 x 30 mm
GYN 2173-04	100 x 35 mm
GYN 2173-05	100 x 40 mm

BREISKY 32 cm

Code	Size
GYN 2174-01	130 x 20 mm
GYN 2174-02	130 x 25 mm
GYN 2174-03	130 x 30 mm
GYN 2174-04	130 x 35 mm
GYN 2174-05	130 x 40 mm

BREISKY 35 cm

GYN 2175-01	160 x 40 mm
--------------------	-------------

BREISKY 37 cm

GYN 2176-01	180 x 40 mm
--------------------	-------------

Hegar Dilatatori - Hegar Dilatators - Hegar Dilatatoren - Hegar Dilateur - Hegar Dilatadores

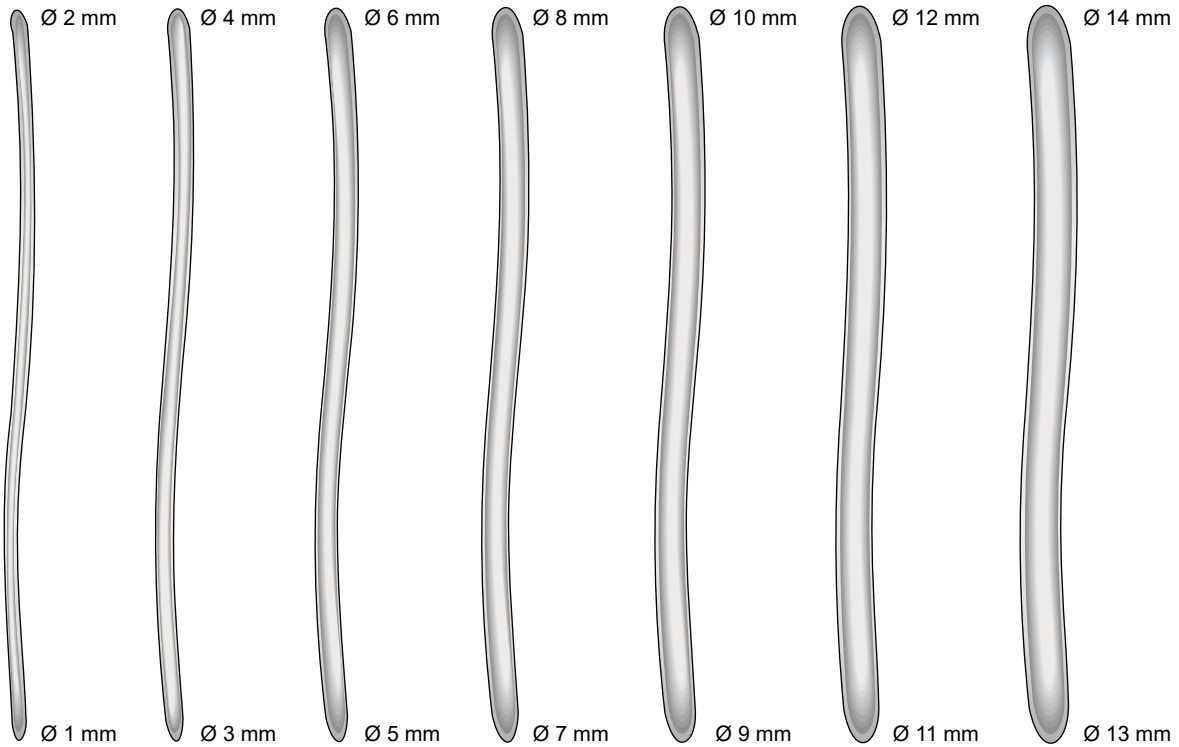

GYN 2177-20 20 cm **GYN 2178-20** 20 cm **GYN 2179-20** 20 cm **GYN 2180-20** 20 cm **GYN 2181-20** 20 cm **GYN 2182-20** 20 cm **GYN 2183-20** 20 cm

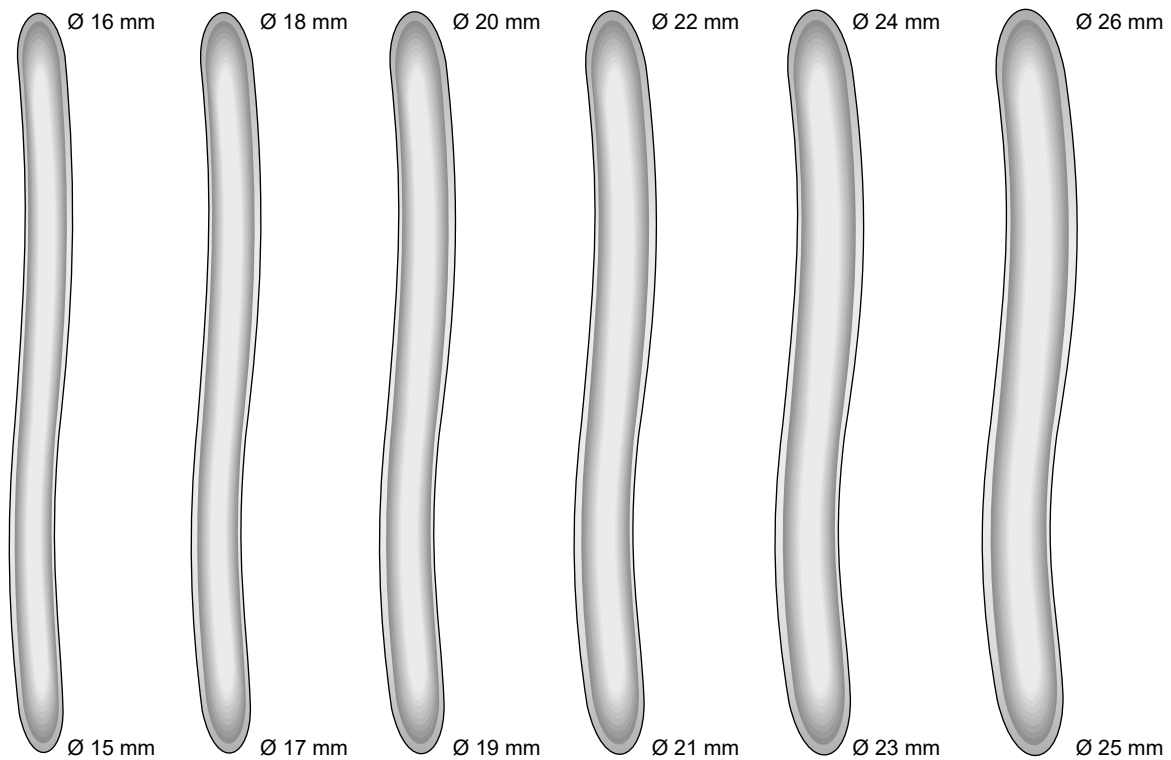

GYN 2184-20 20 cm **GYN 2185-20** 20 cm **GYN 2186-20** 20 cm **GYN 2187-20** 20 cm **GYN 2188-20** 20 cm **GYN 2189-20** 20 cm

GYN 2190
Set completo dilatatori 8 pezzi
Set complete with 8 pieces
Satz-Dilatator, komplett, 8 Stück
Jeu complet avec 8 pieces
Juego completo con 8 piezas

Pratt Dilatatori
Pratt Dilators
Pratt Dilatatoren
Pratt Dilateur
Pratt Diladores

La misura è in French
Breite in French

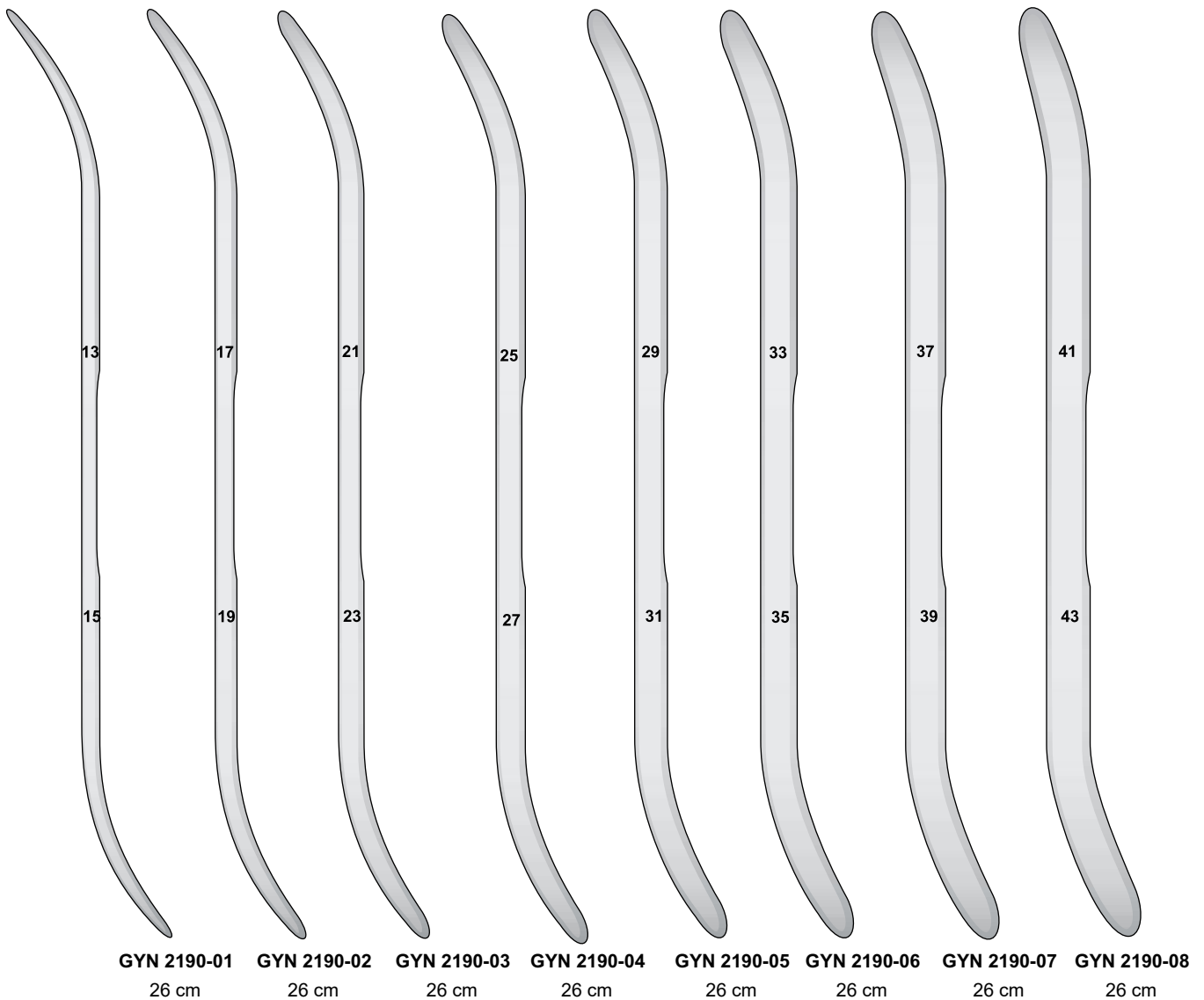

Dilatatori uterin
 Uterine dilators
 Uterus-Dilatatoren
 Dilatateurs du col de l'utéro
 Dilatadores uterinos

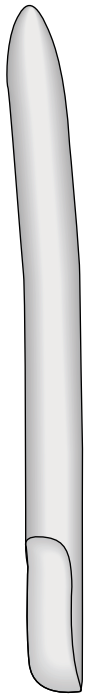

Code	Size	Code	Size	Code	Size	Code	Size
GYN 2191-01	1 mm	GYN 2191-14	14 mm	GYN 2191-27	1½ mm	GYN 2191-40	14½ mm
GYN 2191-02	2 mm	GYN 2191-15	15 mm	GYN 2191-28	2½ mm	GYN 2191-41	15½ mm
GYN 2191-03	3 mm	GYN 2191-16	16 mm	GYN 2191-29	3½ mm	GYN 2191-42	16½ mm
GYN 2191-04	4 mm	GYN 2191-17	17 mm	GYN 2191-30	4½ mm	GYN 2191-43	17½ mm
GYN 2191-05	5 mm	GYN 2191-18	18 mm	GYN 2191-31	5½ mm		
GYN 2191-06	6 mm	GYN 2191-19	19 mm	GYN 2191-32	6½ mm		
GYN 2191-07	7 mm	GYN 2191-20	20 mm	GYN 2191-33	7½ mm		
GYN 2191-08	8 mm	GYN 2191-21	21 mm	GYN 2191-34	8½ mm		
GYN 2191-09	9 mm	GYN 2191-22	22 mm	GYN 2191-35	9½ mm		
GYN 2191-10	10 mm	GYN 2191-23	23 mm	GYN 2191-36	10½ mm		
GYN 2191-11	11 mm	GYN 2191-24	24 mm	GYN 2191-37	11½ mm		
GYN 2191-12	12 mm	GYN 2191-25	25 mm	GYN 2191-38	12½ mm		
GYN 2191-13	13 mm	GYN 2191-26	26 mm	GYN 2191-39	13½ mm		

HEGAR

GYN 2191-01 / GYN 2191-43

18.5 cm

Fig. 9/10
 Ø 4,5/5,0 mm

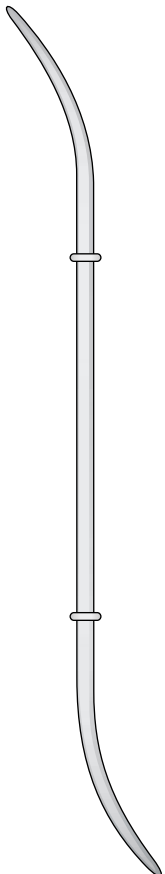

HANK
GYN 2192-26
 26 cm

Fig. 11/12
 Ø 5,5/6,0 mm

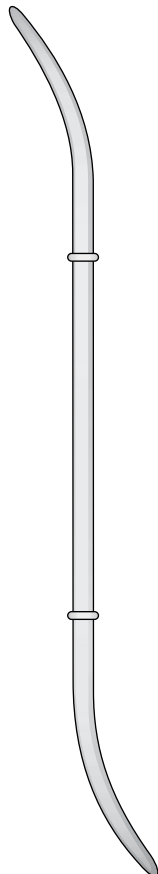

HANK
GYN 2193-26
 26 cm

Fig. 13/14
 Ø 6,5/7,0 mm

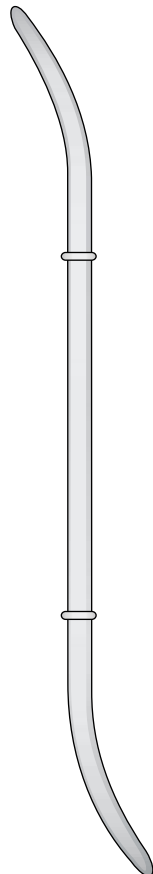

HANK
GYN 2194-26
 26 cm

Fig. 15/16
 Ø 7,5/8,0 mm

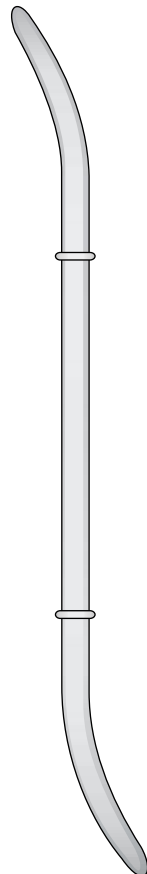

HANK
GYN 2195-26
 26 cm

Fig. 17/18
 Ø 8,5/9,0 mm

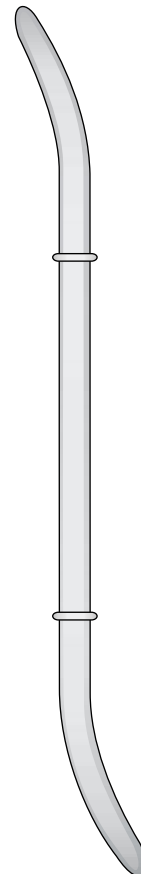

HANK
GYN 2196-26
 26 cm

Fig. 19/20
 Ø 9,5/10 mm

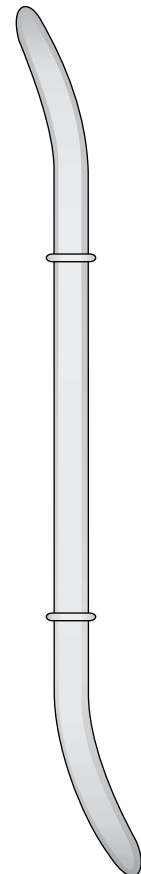

HANK
GYN 2197-26
 26 cm



Graduati in centimetri
Graduated in centimeters
Zentimetereinteilung
Gradué en centimètres
Graduado en centímetros

Malleabile
Malleable
Biagsam
Malléables
Maleables

Malleabile
Malleable
Biagsam
Malléables
Maleables

Rigido
Rigid
Fest
Rigides
Rigidos

Malleabile
Malleable
Biagsam
Malléables
Maleables

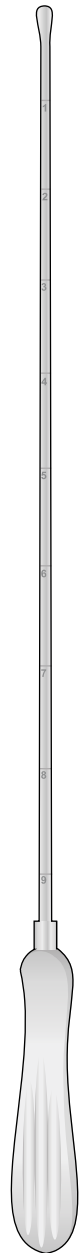
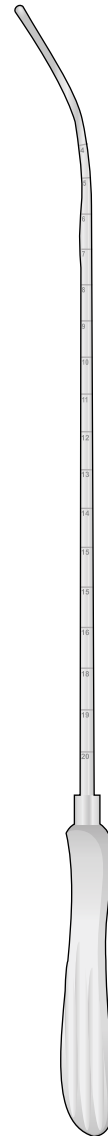
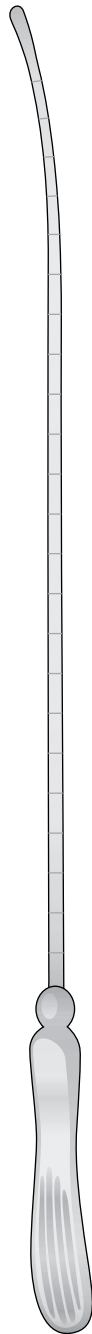
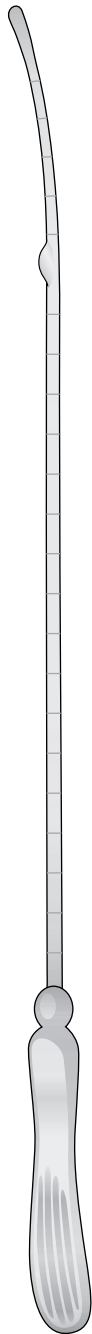
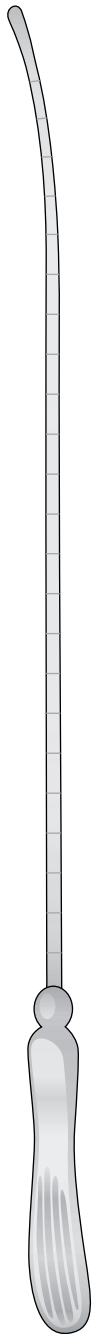

GYN 2198-01
Ø 2 mm
GYN 2198-02
Ø 3 mm
GYN 2198-03
Ø 4 mm

GYN 2200-01
Ø 3 mm
GYN 2200-02
Ø 4 mm

SIMS	SIMPSON	SIMS	VALLEIX	MARTIN	MAYO
GYN 2198-01 /GYN 2198-03	GYN 2199-03 Ø 3 mm	GYN 2200-01 /GYN 2200-02	GYN 2201-04 Ø 4 mm	GYN 2202-03 Ø 3 mm	GYN 2203-05 Ø 5 mm
32 cm	32 cm	32 cm	26.5 cm	30 cm	33 cm

Pinze uterine
 Uterine tenaculum forceps
 Hakenzangen
 Pincés pour l'utérus
 Pinzas para coger el cuello del útero

Amniotomo per la
 vescica amniotica
 Amniotome for the
 amnion bladder
 Amniotom für die
 Amnionblase
 Amniotome pour la
 vésicule amniotique
 Amniótomo para la
 vesicula amniótica

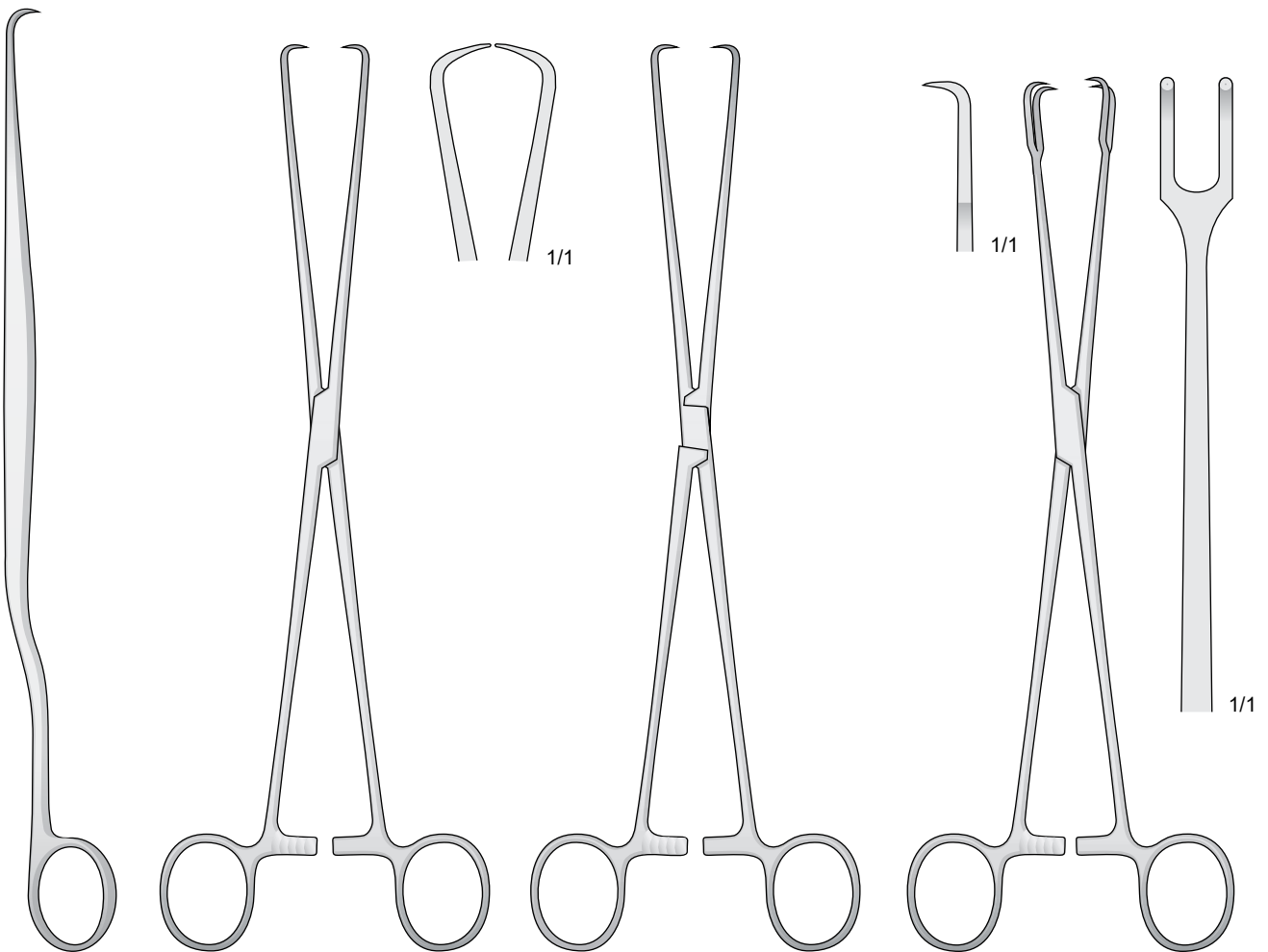

BEACHAM
GYN 2204-26
 26 cm

BRAUN
GYN 2205-25
 25 cm

POZZI
GYN 2206-25
 25 cm

SCHROEDER
GYN 2207-24
 24 cm

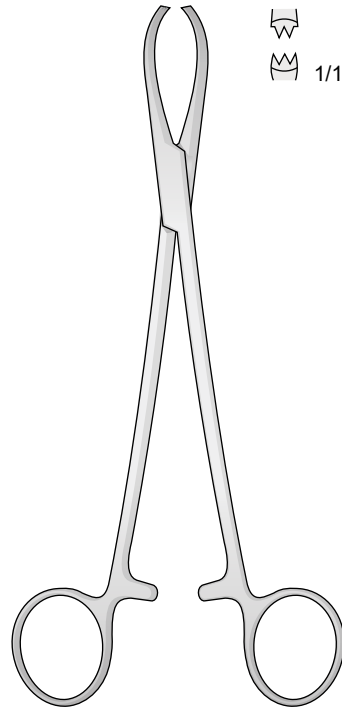

LITTLEWOOD

GYN 2208-18 18.5 cm

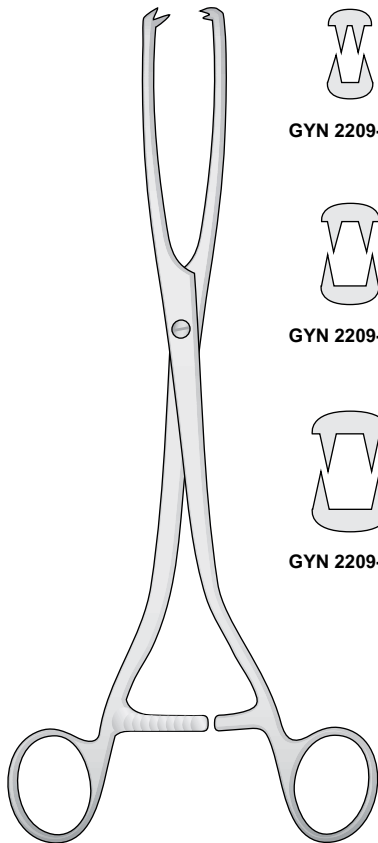

GYN 2209-01

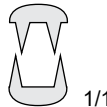

GYN 2209-02

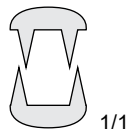

GYN 2209-03

MUSEUX

GYN 2209-01 / GYN 2209-03

24 cm

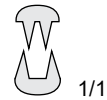
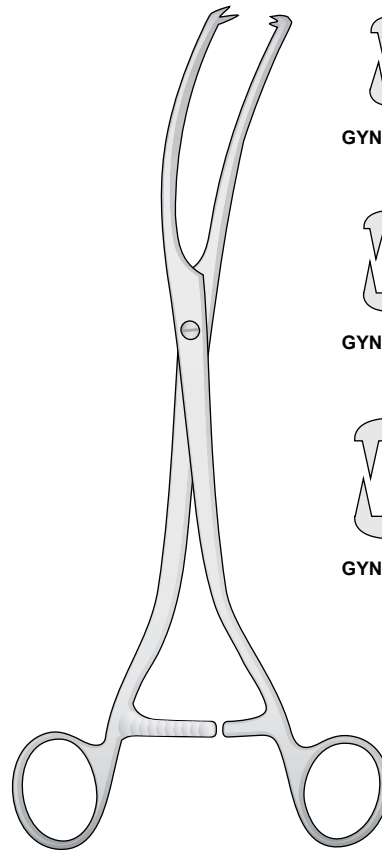

GYN 2210-01

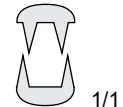

GYN 2210-02

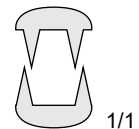

GYN 2210-03

MUSEUX

GYN 2210-01 / GYN 2210-03

24 cm

Pinzette per tube

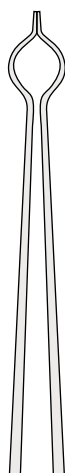
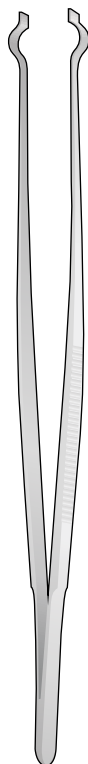

GYN 2211-01
Ø 6 mm

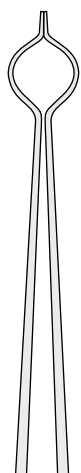

GYN 2211-02
Ø 8 mm

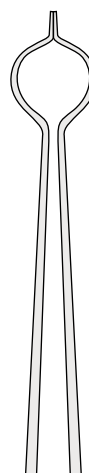

GYN 2211-03
Ø 10 mm

NEUBÜSER

GYN 2211-01 / GYN 2211-03

20 cm



DOYEN

GYN 2212-15 15 cm



DOYEN

GYN 2213-17 17 cm

Curette per biopsia endouterina
 Endometrical Biopsy curette
 EndometrGYNm-Strichkürette
 Curette pour biopsie intra-utérines
 Cureta para biopsia endo-uterina

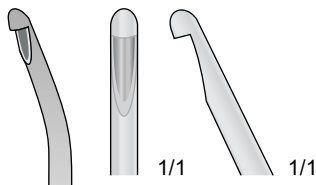

GYN 2214-01
3,5 mm

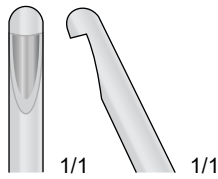

GYN 2214-02
5 mm

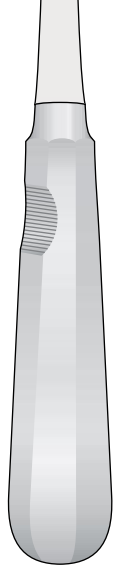

MÜNCHEN

GYN 2214-01 / GYN 2214-02
27 cm

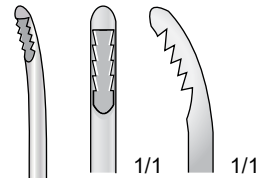

GYN 2215-01
Ø 1 mm
GYN 2215-02
Ø 2 mm
GYN 2215-03
Ø 3 mm
GYN 2215-04
Ø 4 mm

NOVAK

GYN 2215-01 / GYN 2215-04
23 cm

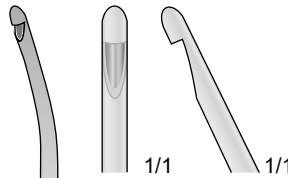

RANDALL

GYN 2216-23 23 cm

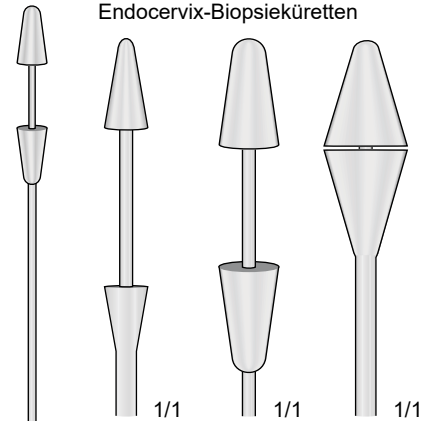

GYN 2217-01 Ø 5,7 mm
GYN 2217-02 Ø 8 mm
GYN 2217-03 Ø 11 mm

GUSBERG

GYN 2217-01 / GYN 2217-03
24 cm

Pinze per biopsia
Biopsy specimen forceps
Probeexzisionzangen
Pincas emporte-pièces à biopsie
Pinzas saca-bocados para biopsia

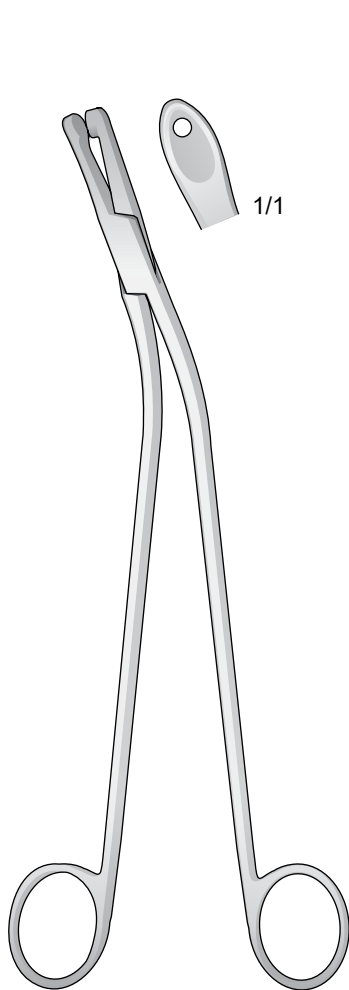

GELLHORN

GYN 2218-23 23 cm

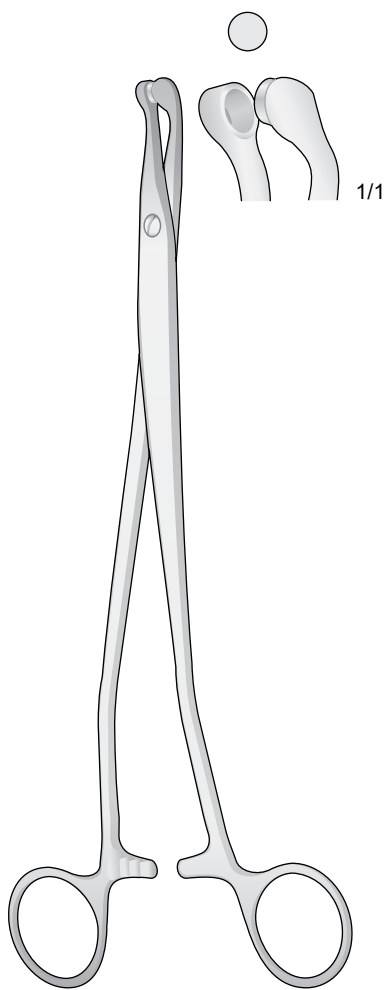

THOMS-GAYLOR

GYN 2219-24 24 cm

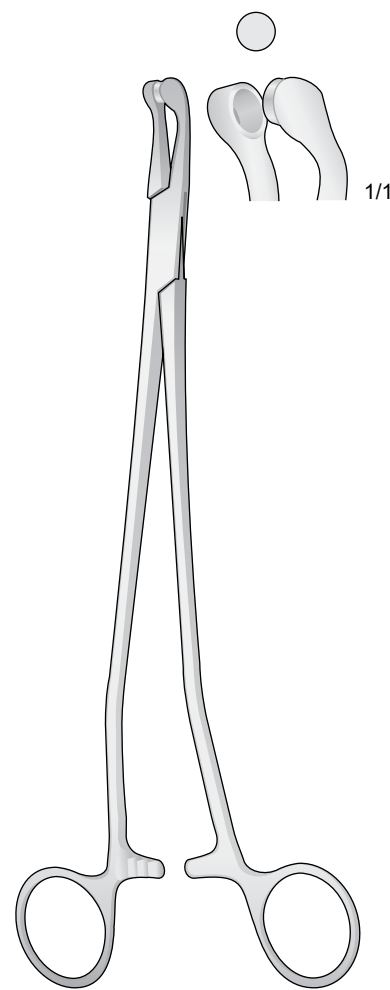

THOMS-GAYLOR

GYN 2220-22 22 cm
GYN 2220-24 24 cm

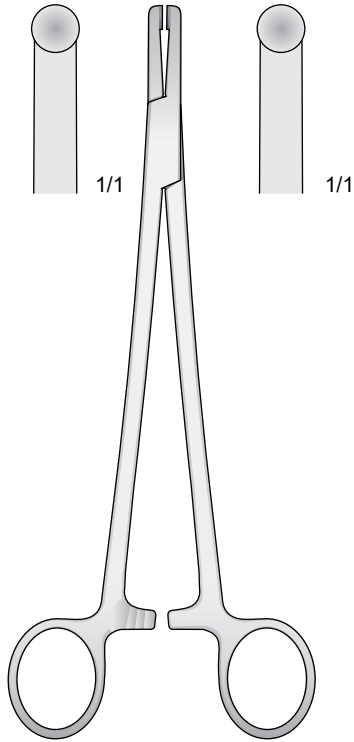

GYN 2221-20 20.5 cm

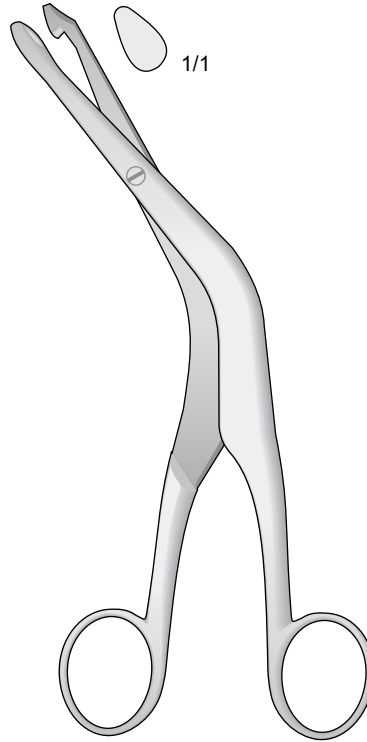

FAURE

GYN 2222-21 21 cm

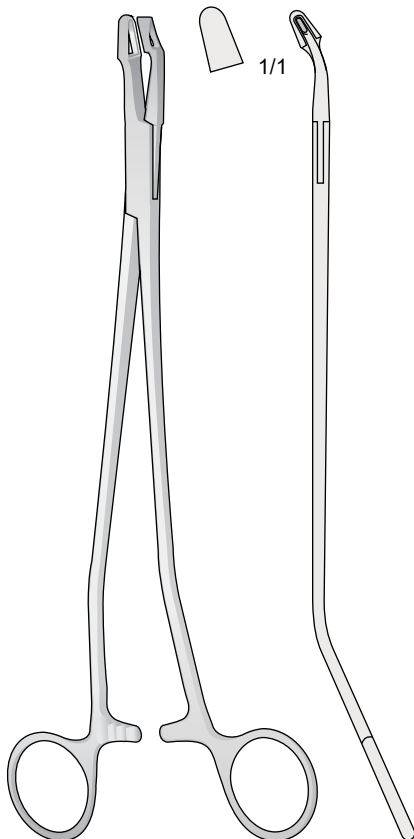

VAN DOREN

GYN 2223-25 25 cm

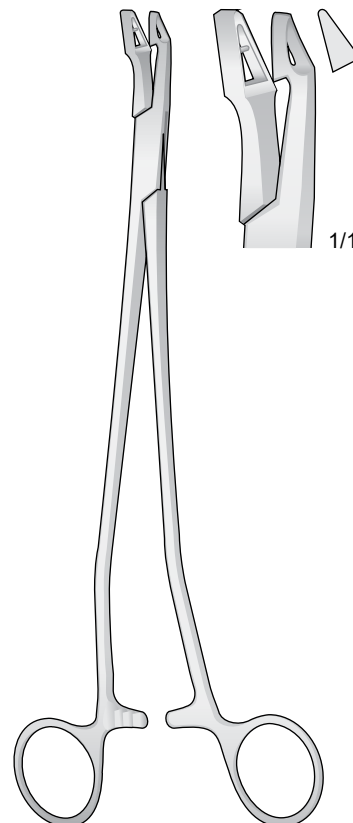

VAN DOREN

GYN 2224-24 24 cm

Pinze per biopsia
 Biopsy specimen forceps
 Probeexzisionzangen
 Pincas emporte-pièces à biopsie
 Pinzas saca-bocados para biopsia

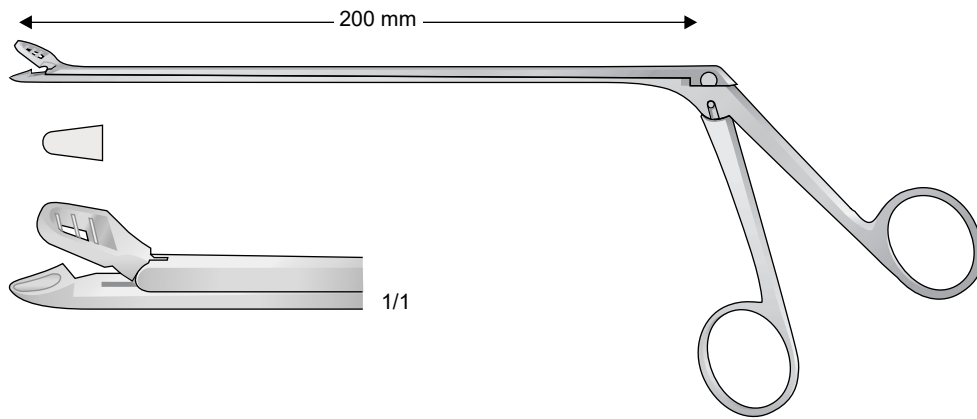

ALEXANDER

GYN 2225-20 20 cm

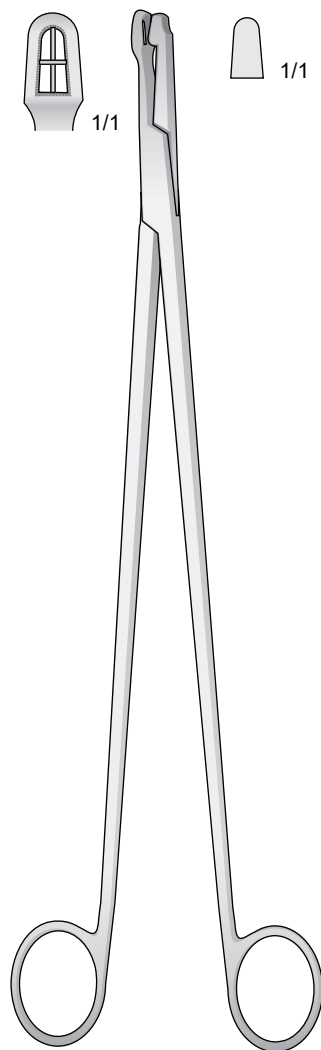

SCHUBERT

GYN 2226-21 21 cm
GYN 2226-29 29 cm

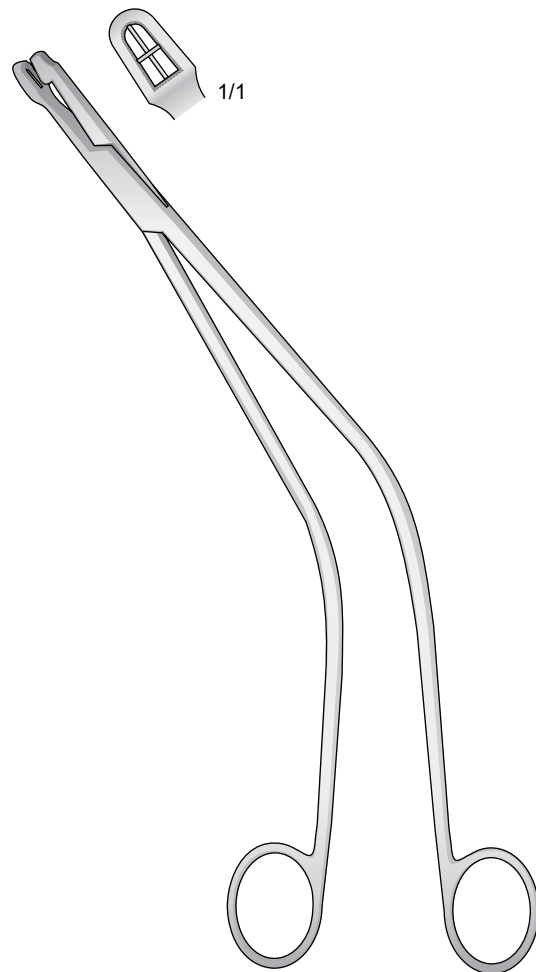

SCHUBERT

GYN 2227-26 26 cm

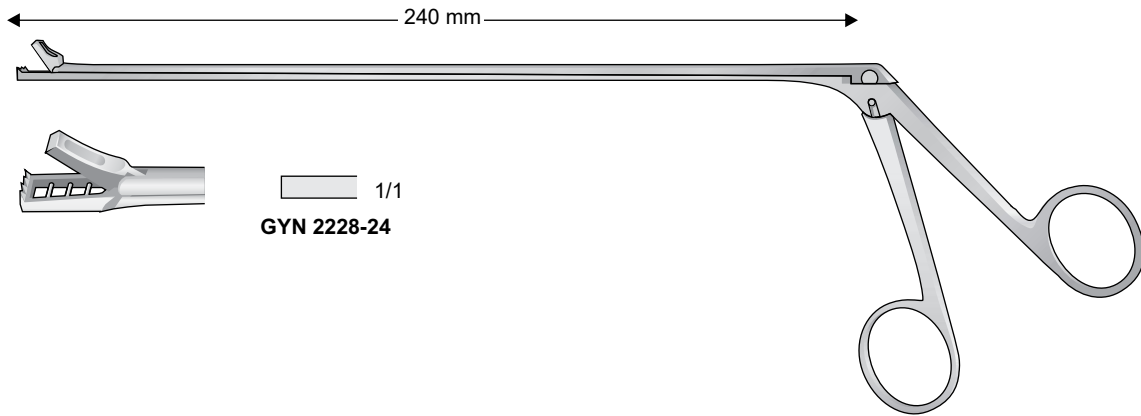

KEVORKIAN

GYN 2228-24 24 cm

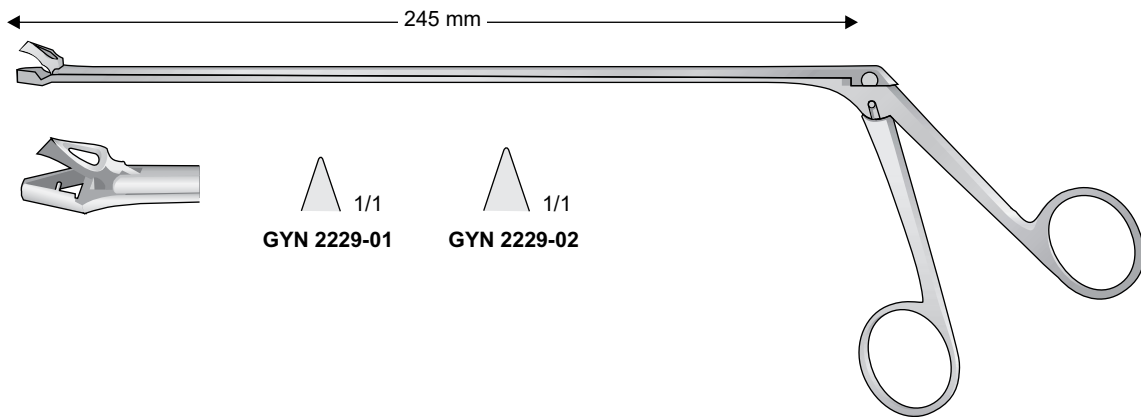

SCHUMACHER

GYN 2229-01 / GYN 2229-02

24.5 cm

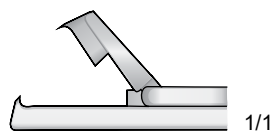

1/1

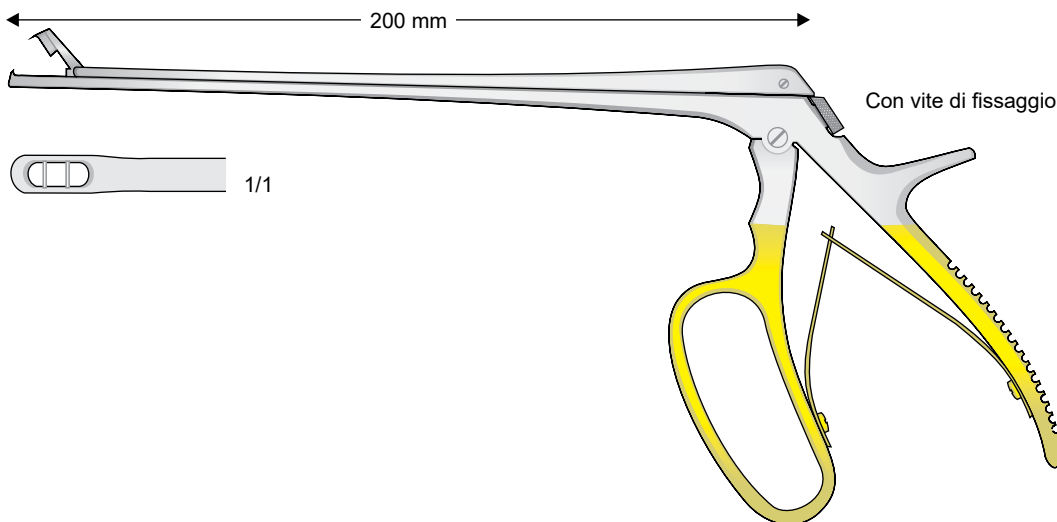

TISCHLER-MORGAN

GYN 2230-20 20 cm

Curette uterine
Uterine curettes
Uterusküretten
Utérines curettes
Curetas uterinas

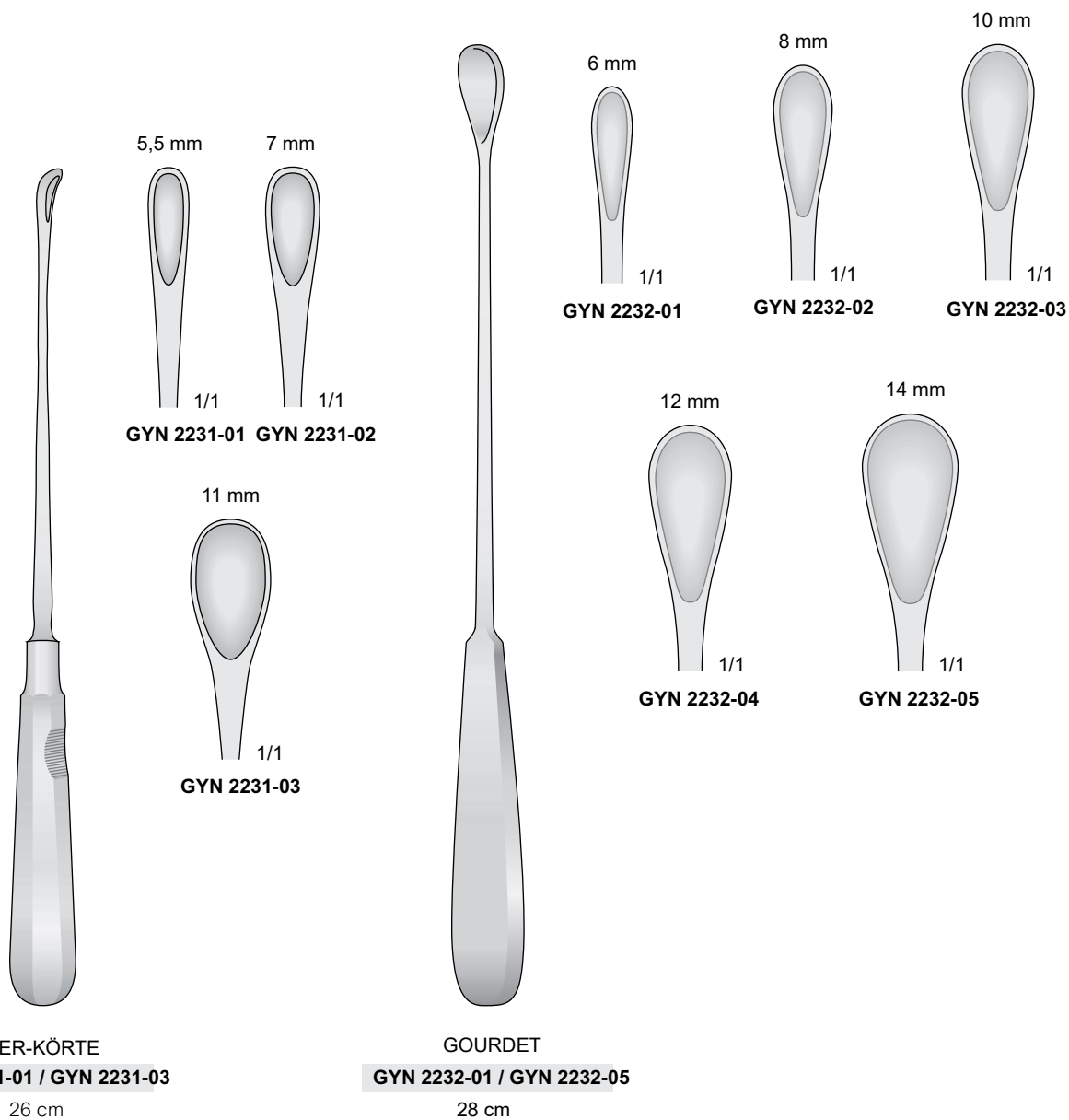

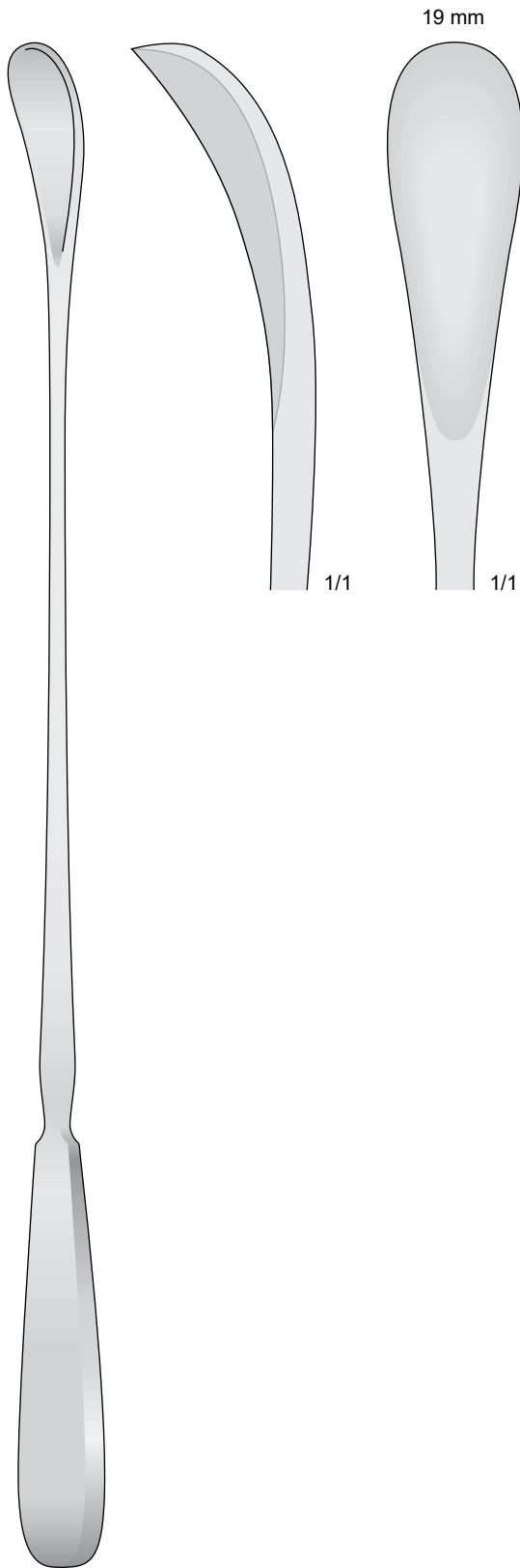

WALLICH
GYN 2233-42 42 cm

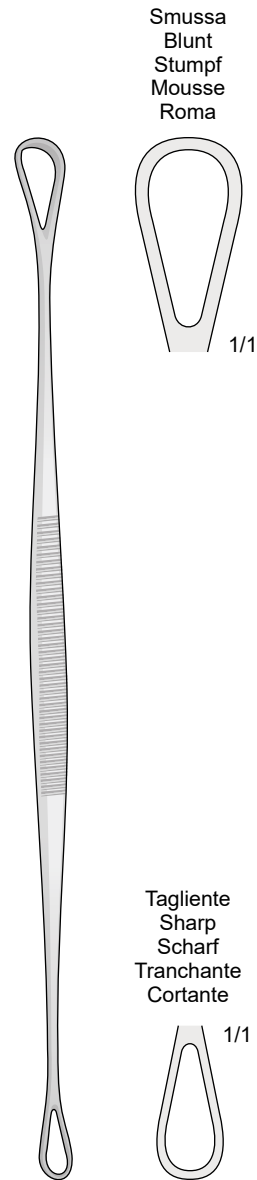

BLAKE
GYN 2234-27 27.5 cm

Taglienti
 Scharp
 Scharf
 Tranchantes
 Cortantes

Smussa
 Blunt
 Stumpf
 Mousse
 Romas

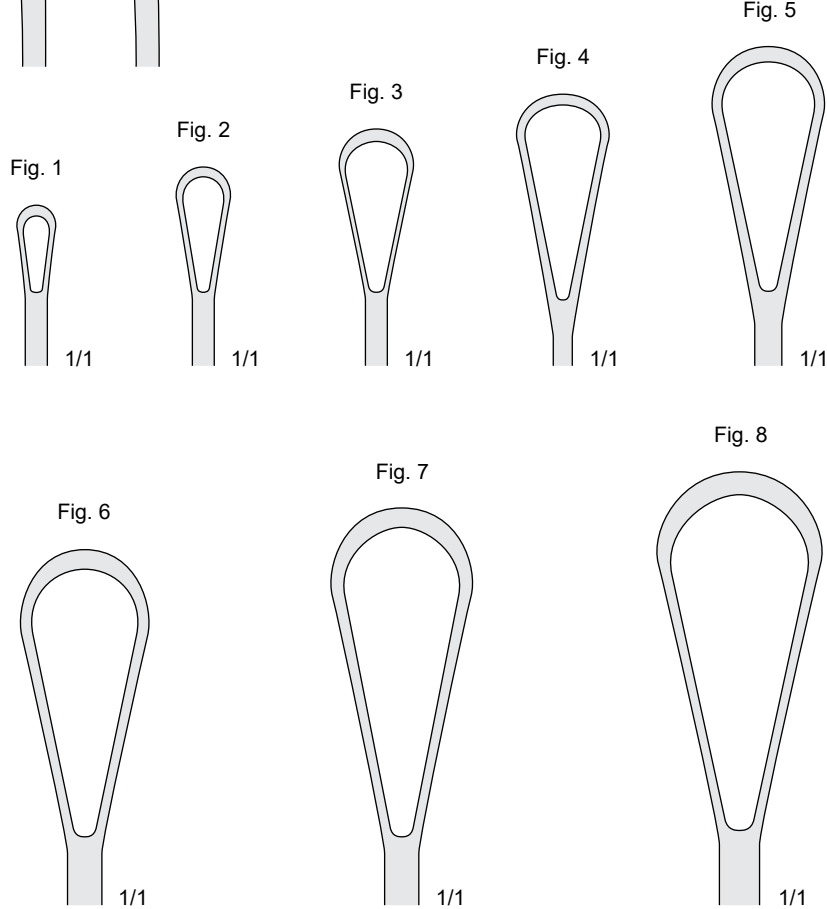
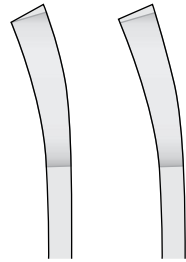
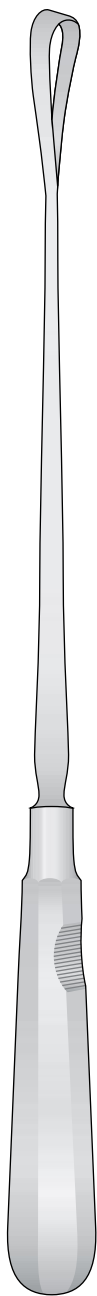
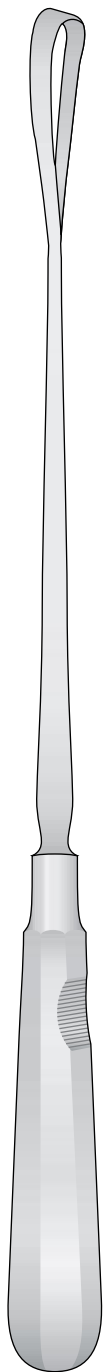

Fig.	Larghezza Width Breite	Taglienti-rigide Sharp-rigid Scharf-fest Tranchantes-rigides Cortantes-rigidas	Smusse-rigide Blunt-rigid Stumpf-fest Mousse-rigides Romas-rigidas
1	4 mm	GYN 2235-01	GYN 2235-09
2	6 mm	GYN 2235-02	GYN 2235-10
3	8 mm	GYN 2235-03	GYN 2235-11
4	10 mm	GYN 2235-04	GYN 2235-12
5	12 mm	GYN 2235-05	GYN 2235-13
6	14 mm	GYN 2235-06	GYN 2235-14
7	16 mm	GYN 2235-07	GYN 2235-15
8	18 mm	GYN 2235-08	GYN 2235-16

RECAMIER

GYN 2235-01 / GYN 2235-16

31 cm



BUMM

GYN 2236-01 / GYN 2236-04

31 cm

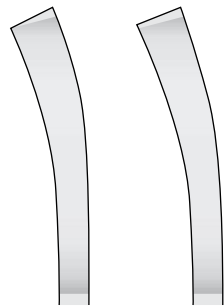

Tagliente
Scharp
Scharf
Tranchantes
Cortantes

Smussa
Blunt
Stumpf
Mousse
Romas

Malleabile
Malleable
Biegsam
Souples
Maleables

Fig. 3

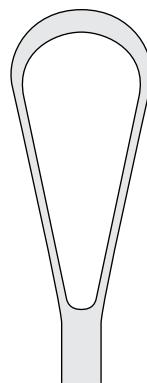

Fig. 4

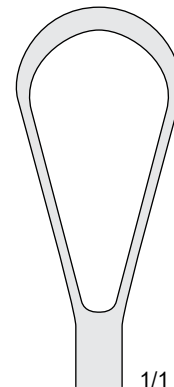

Fig. Larghezza
Width
Breite

Taglienti
Sharp
Scharf
Tranchantes
Cortantes

Smusse
Blunt
Stumpf
Mousse
Romas

3	18 mm	GYN 2236-01	GYN 2236-03
4	20 mm	GYN 2236-02	GYN 2236-04

Curette uterine
 Uterine curettes
 Uterusküretten
 Utérines curettes
 Curetas uterinas

Fig.	Larghezza Breite Width	Smusse malleabili - Blunt malleable Stumpf biegsam - Mousse malléables Romos maleables
0	16 mm	GYN 2237-01
1	18 mm	GYN 2237-02
2	19,5 mm	GYN 2237-03
3	21,5 mm	GYN 2237-04
4	23,5 mm	GYN 2237-05
5	26 mm	GYN 2237-06
6	28,5 mm	GYN 2237-07

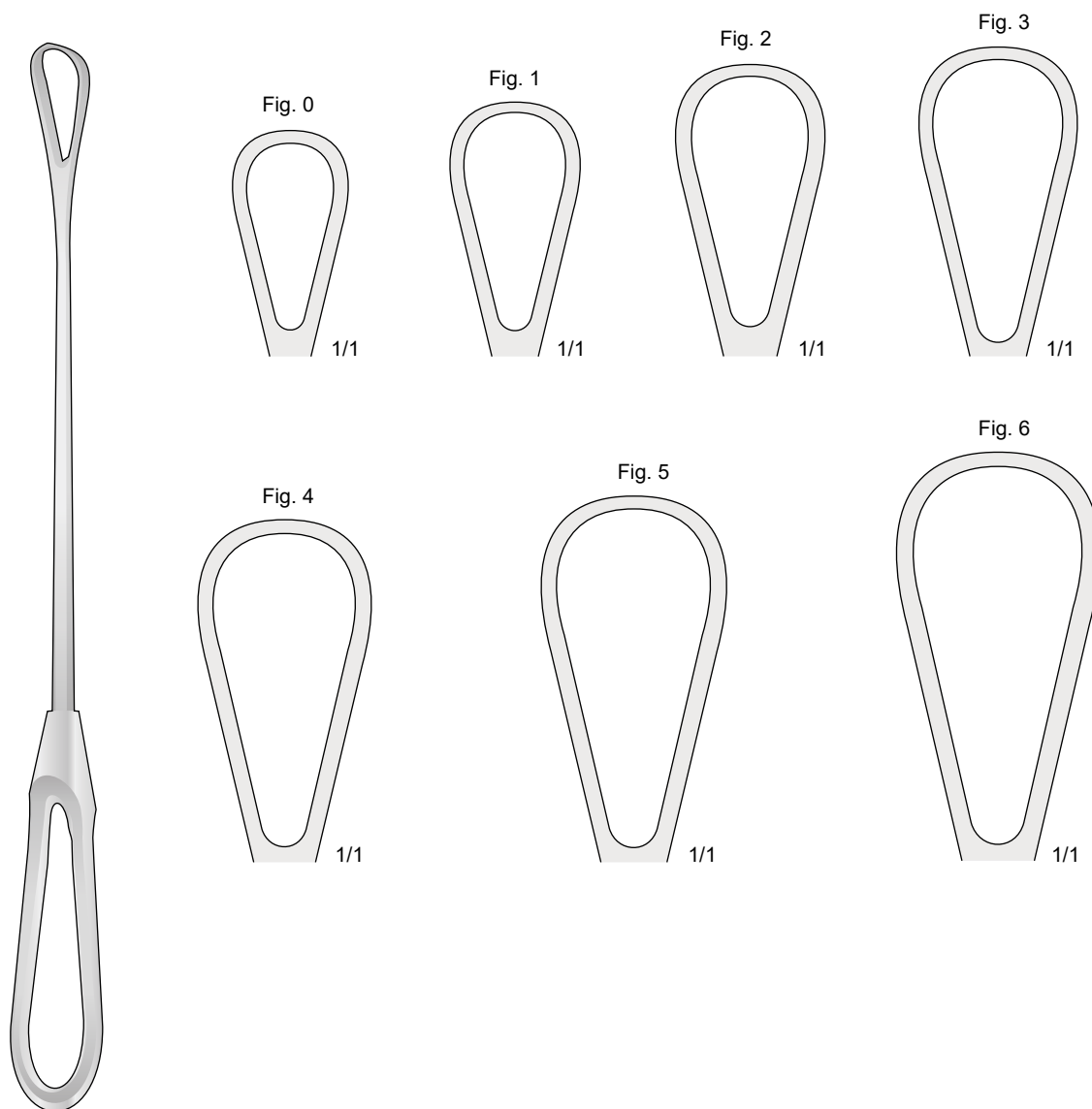

BUMM

GYN 2237-01 / GYN 2237-07

29 cm

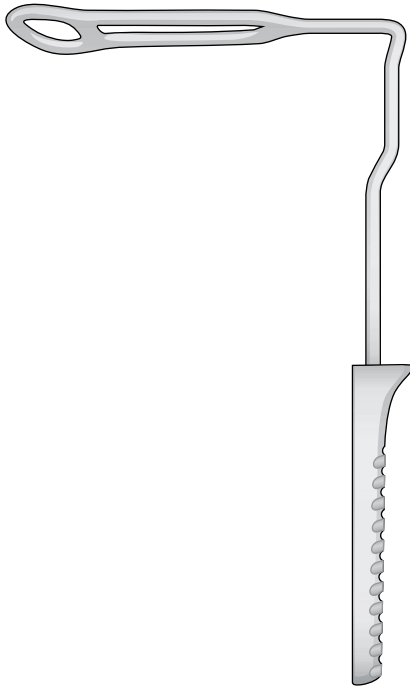

GENTOFT
GYN 2238-21 21 cm

GYN 2238
Set 2 pezzi
Set 2 pieces
Set 2 Stück
Set 2 pièces
Set 2 piezas
GYN 2238-21+GYN 2238-23

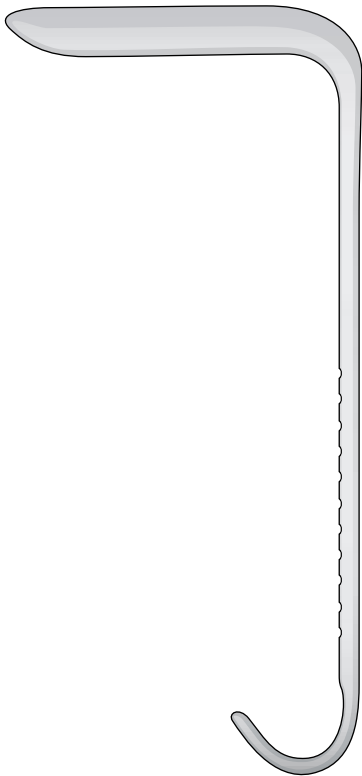

FENO
GYN 2238-23 23 cm

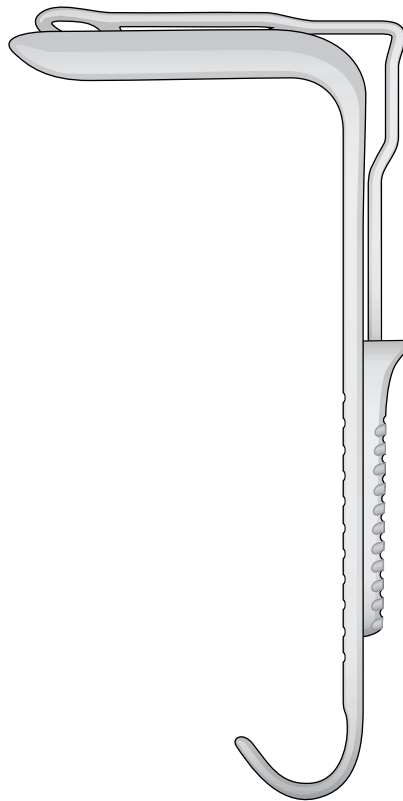

GYN 2239-23 23 cm

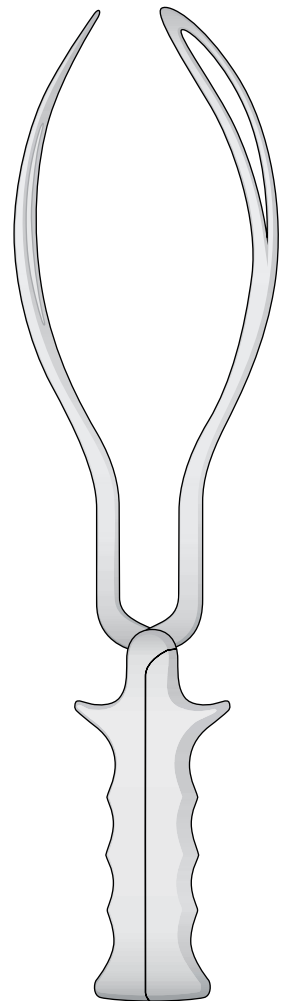

SIMPSON-BRAUN
GYN 2240-36 36.5 cm



we take a closer look

Suction Tubes

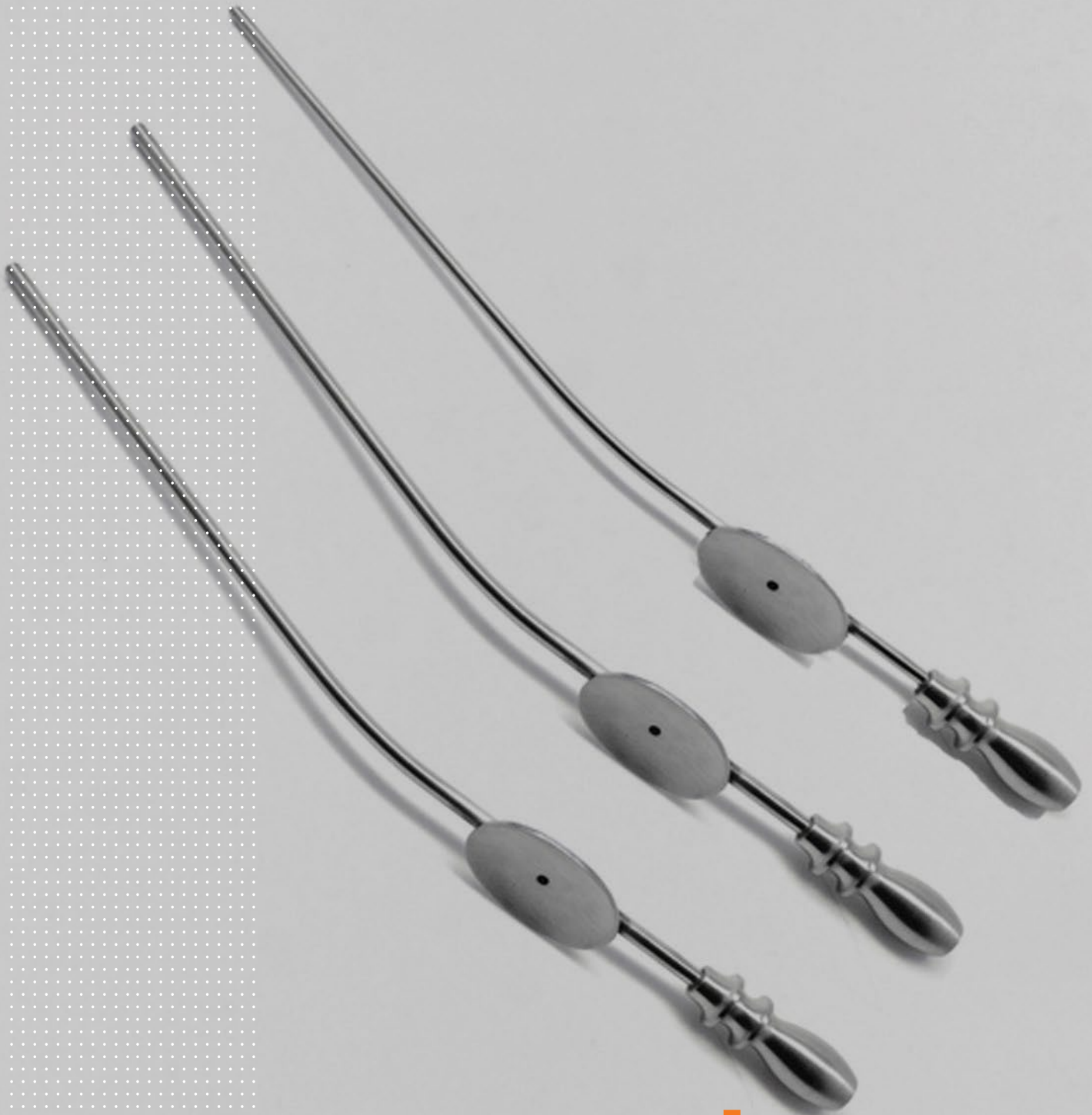

Saugkanülen
Canules d'aspiration
Cánulas de aspiración
Cannule per aspirazione

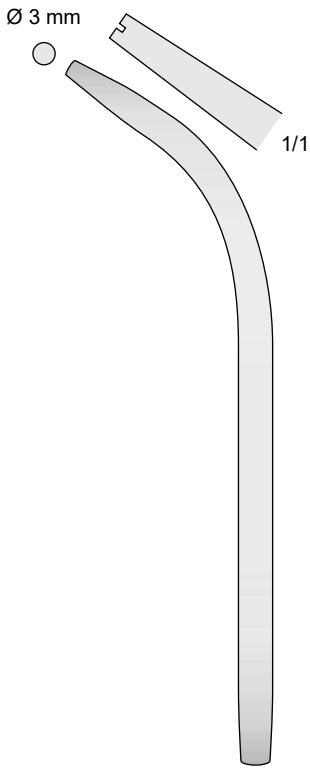

ST 2245-14 14 cm

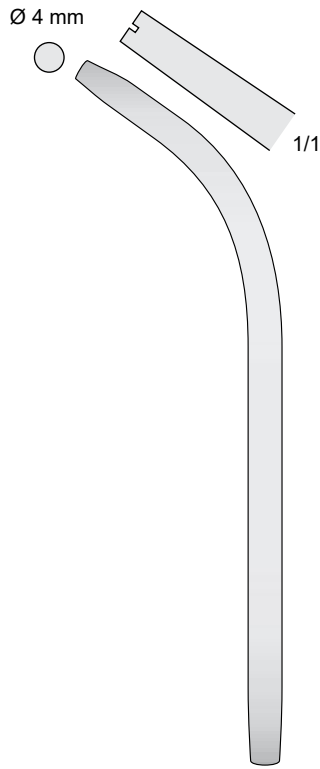

ST 2246-14 14 cm

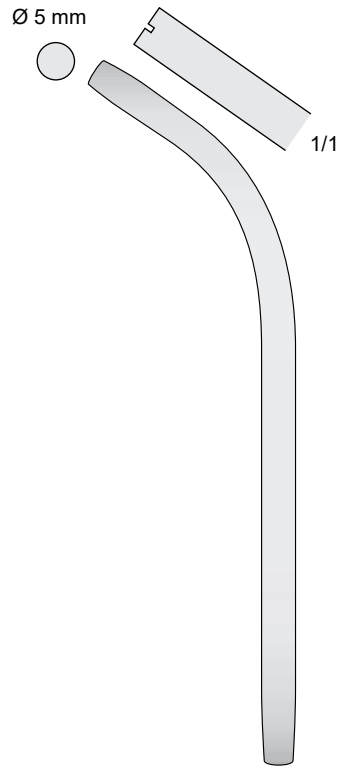

ST 2247-14 14 cm

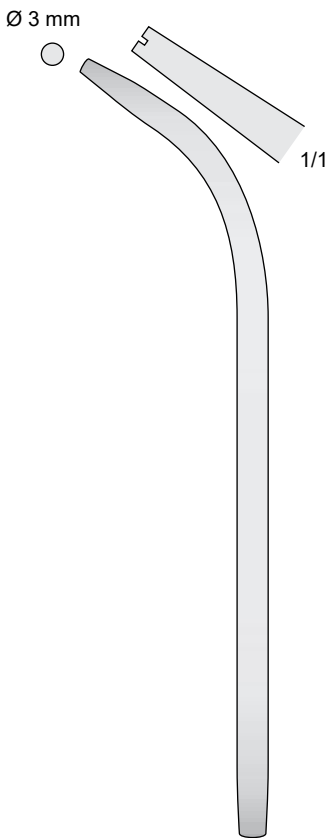

ST 2248-17 17 cm

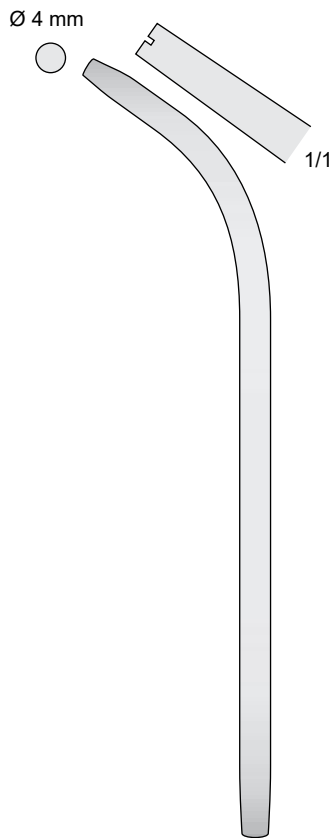

ST 2249-17 17 cm

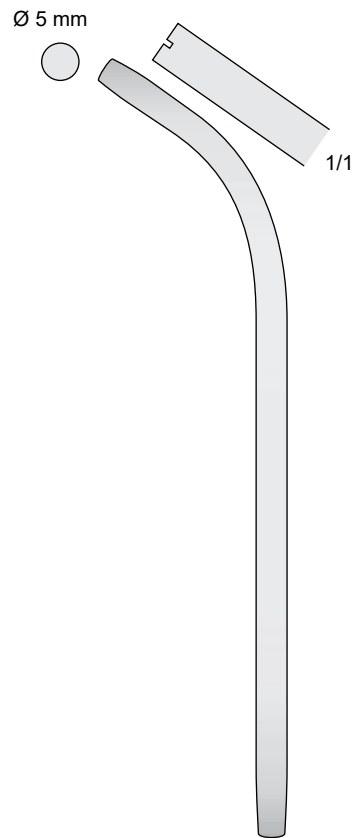

ST 2250-17 17 cm

Canule per aspirazione
Suctions tube
Absaugkanüle
Canules aspiratrice
Cánulas aspiradoras

Ø 2 mm int.

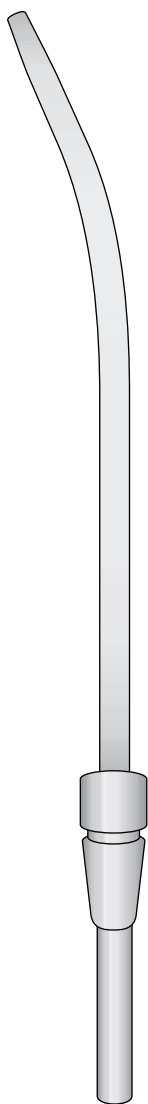

Mc KESSON
ST 2251-18
18 cm

Ø 3 mm int.

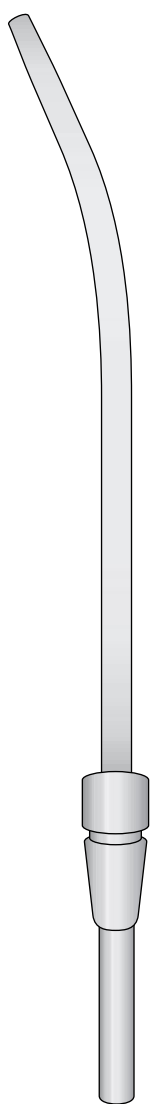

Mc KESSON
ST 2252-18
18 cm

Ø 4 mm int.

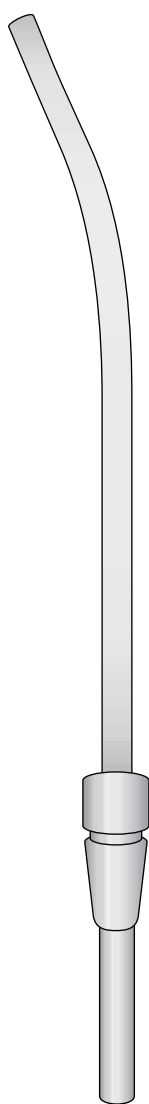

Mc KESSON
ST 2253-18
18 cm

Ø 4 mm int.

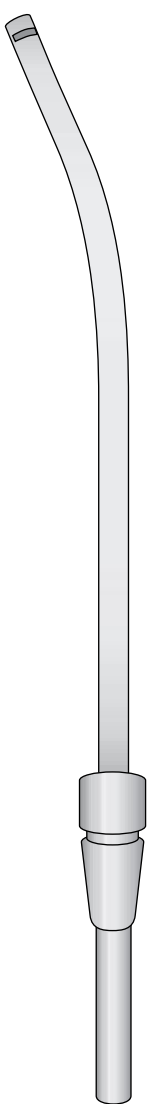

Mc KESSON
ST 2254-18
18 cm

Ø 3 mm

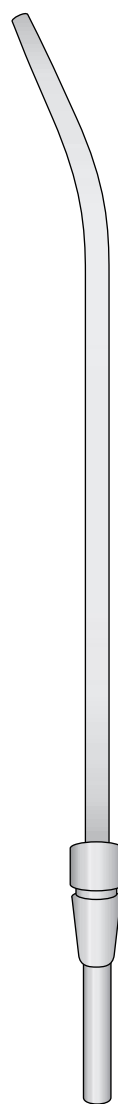

Mc KESSON
ST 2255-24
24 cm

Ø 4 mm

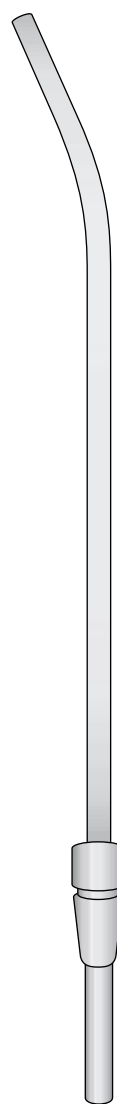

Mc KESSON
ST 2256-24
24 cm

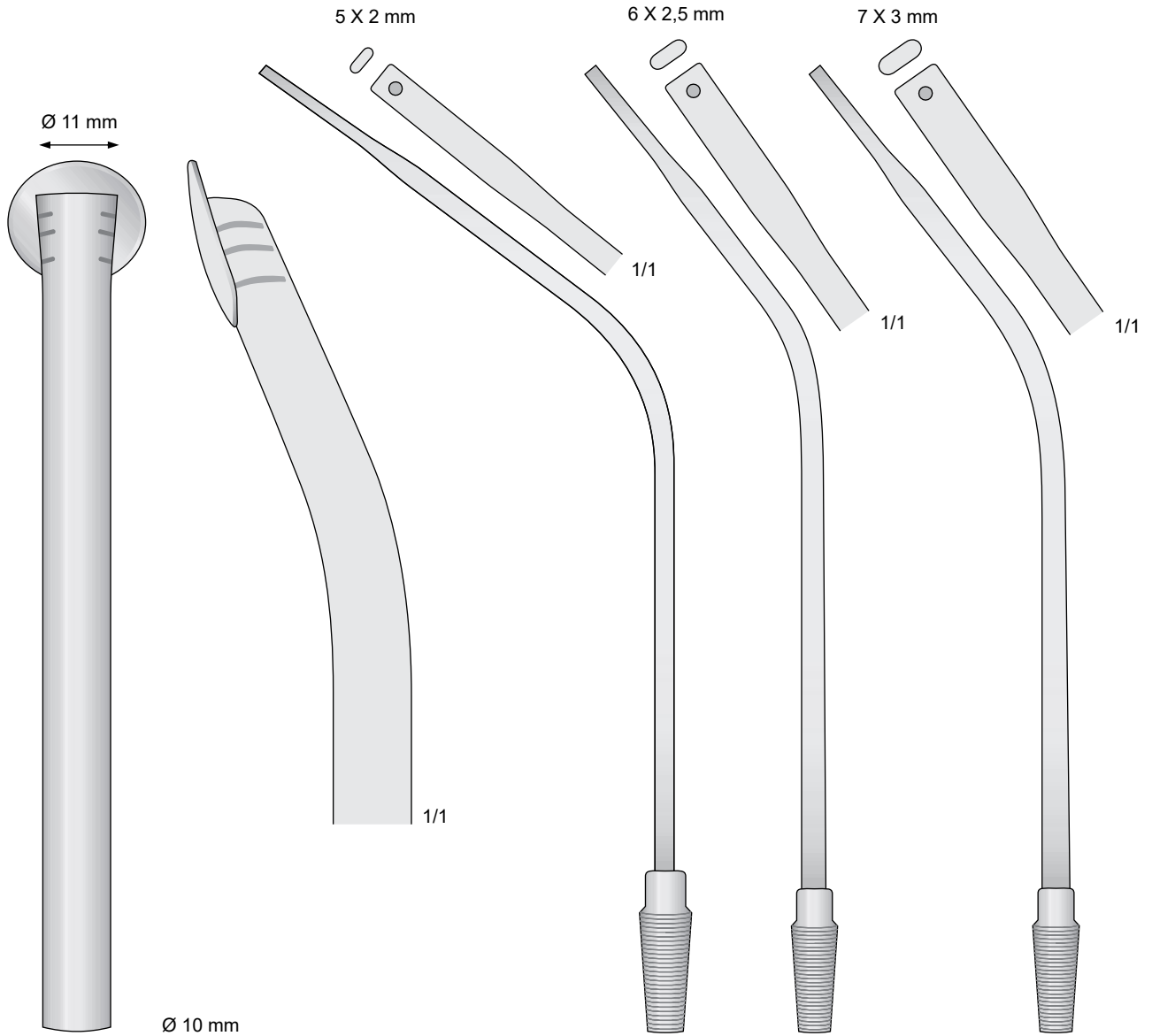

ST 2257-16 16 cm

ST 2258-19
190 mm

ST 2259-20
200 mm

ST 2260-20
200 mm

Canule per aspirazione
Suctions tube
Absaugkanüle
Canules aspiratrice
Cánulas aspiradoras

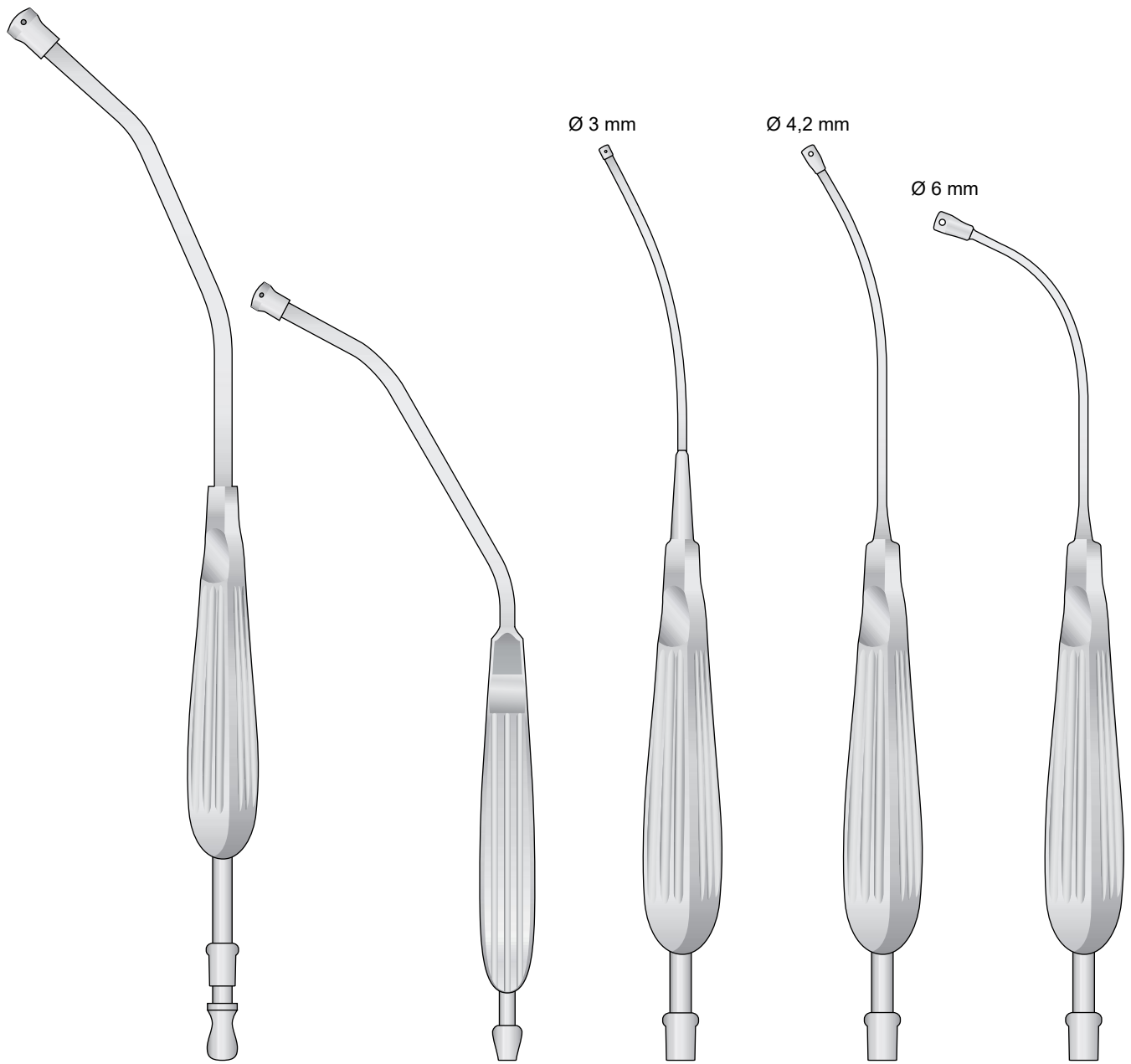

YANKAUER
ST 2261-31
31 cm

BABY-YANKAUER
ST 2262-20
20 cm

ANDREWS-PYNCHON
ST 2263-25
25 cm

ANDREWS-PYNCHON
ST 2264-25
25 cm

ANDREWS-PYNCHON
ST 2265-23
23 cm



ST 2266
Manico portacanule
Set - Satz - Jeu - Jeugo

Completo con 4 canule
Complet with 4 tubes
Komplett mit 4 Kanülen
Complete avec 4 canules
Completo con 4 cànulas

ST 2268
Manico portacanule
Set - Satz - Jeu - Jeugo

Completo con 3 canule
Complet with 3 tubes
Komplett mit 3 Kanülen
Complete avec 3 canules
Completo con 3 cànulas

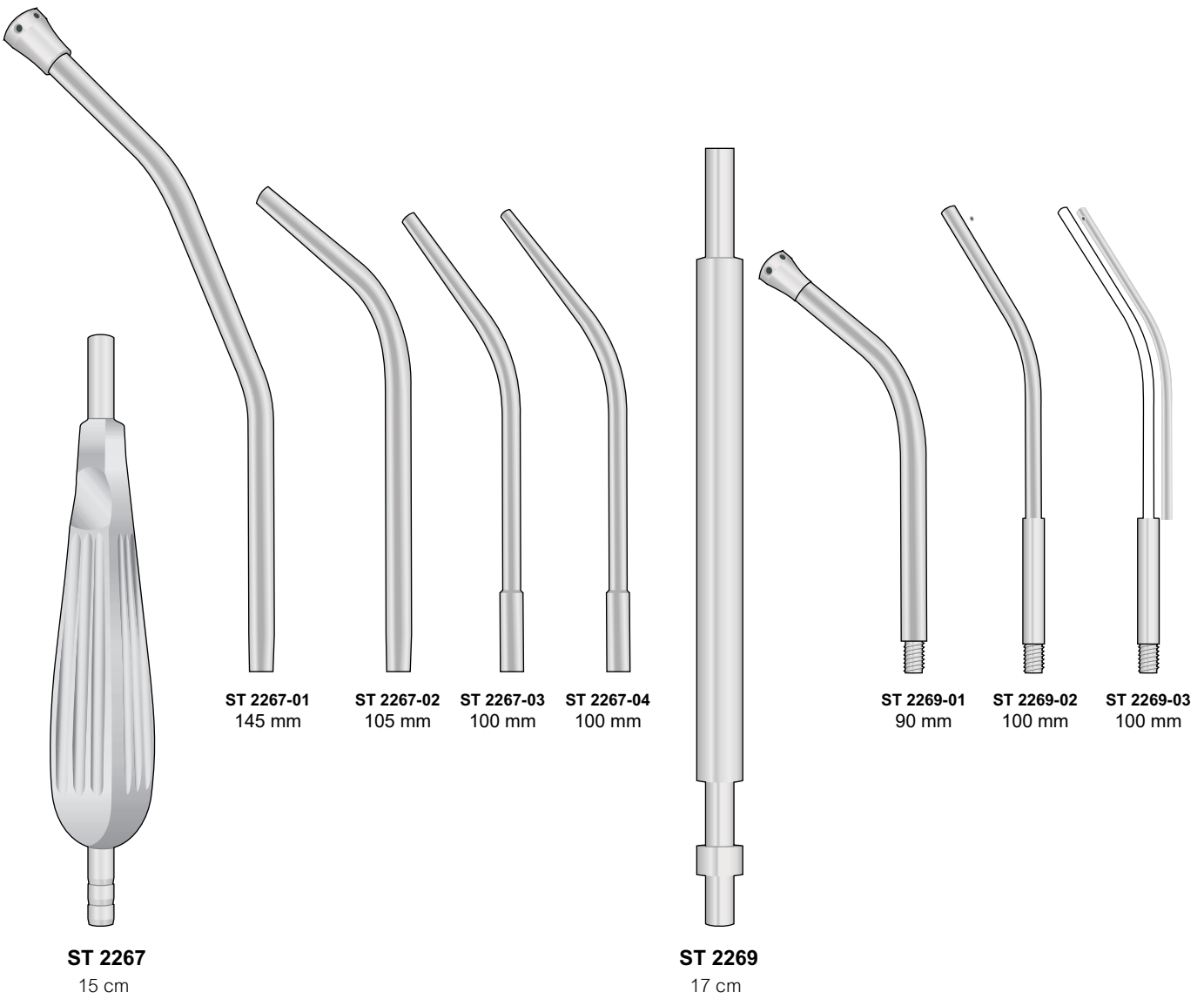

ST 2267-01 145 mm
ST 2267-02 105 mm
ST 2267-03 100 mm
ST 2267-04 100 mm

ST 2269-01 90 mm
ST 2269-02 100 mm
ST 2269-03 100 mm

ST 2267
15 cm

ST 2269
17 cm

Canule per aspirazione
 Suctions tube
 Absaugkanüle
 Canules aspiratrice
 Cànulas aspiradoras

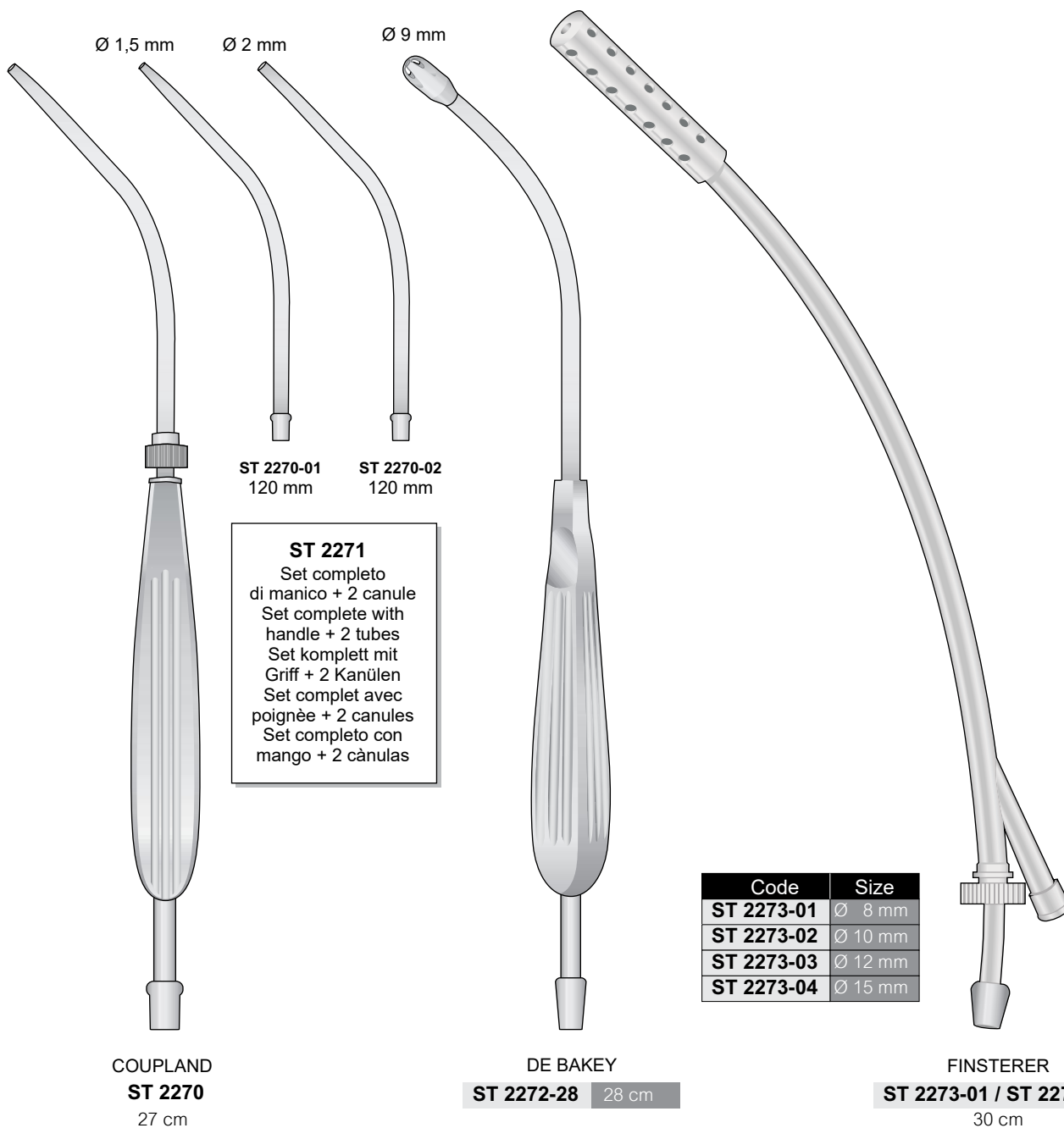

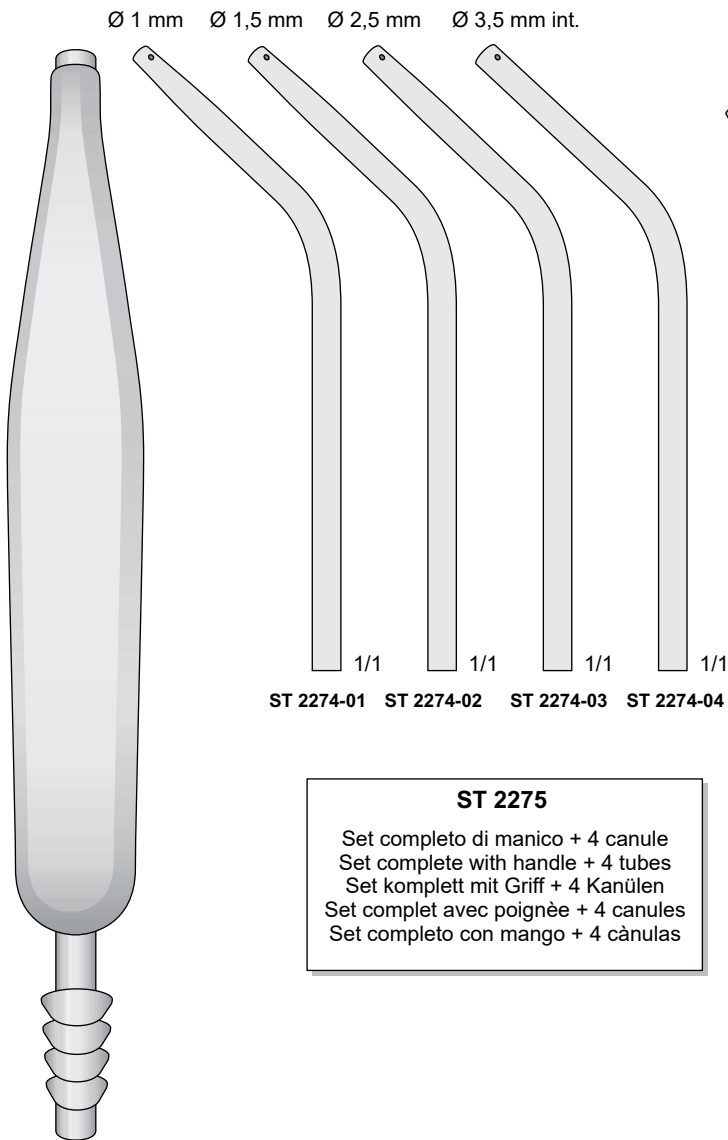

COUPLAND
ST 2274
15 cm

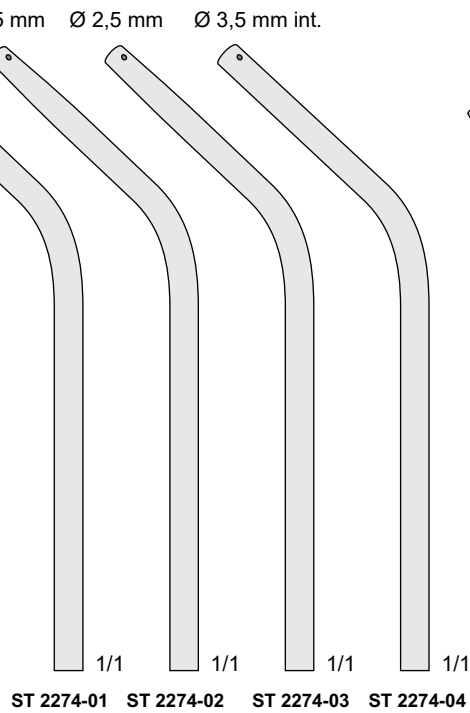

ST 2275
Set completo di manico + 4 canule
Set complete with handle + 4 tubes
Set komplett mit Griff + 4 Kanülen
Set complet avec poignée + 4 canules
Set completo con mango + 4 cánulas

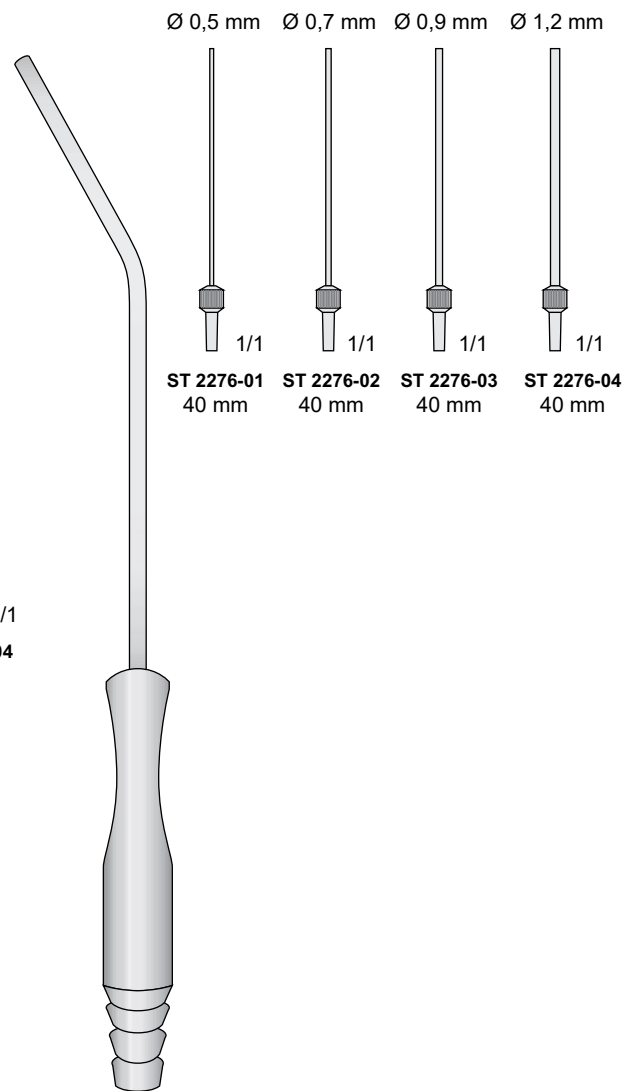

WULLSTEIN
ST 2276
14 cm

Canule per aspirazione
 Suctions tube
 Absaugkanüle
 Canules aspiratrice
 Cànulas aspiradoras

Acciaio chirurgico - Stainless steel - Rostfrei - Acier - Acero



ST 2277-18 18 cm

ST 2278-17 17.5 cm

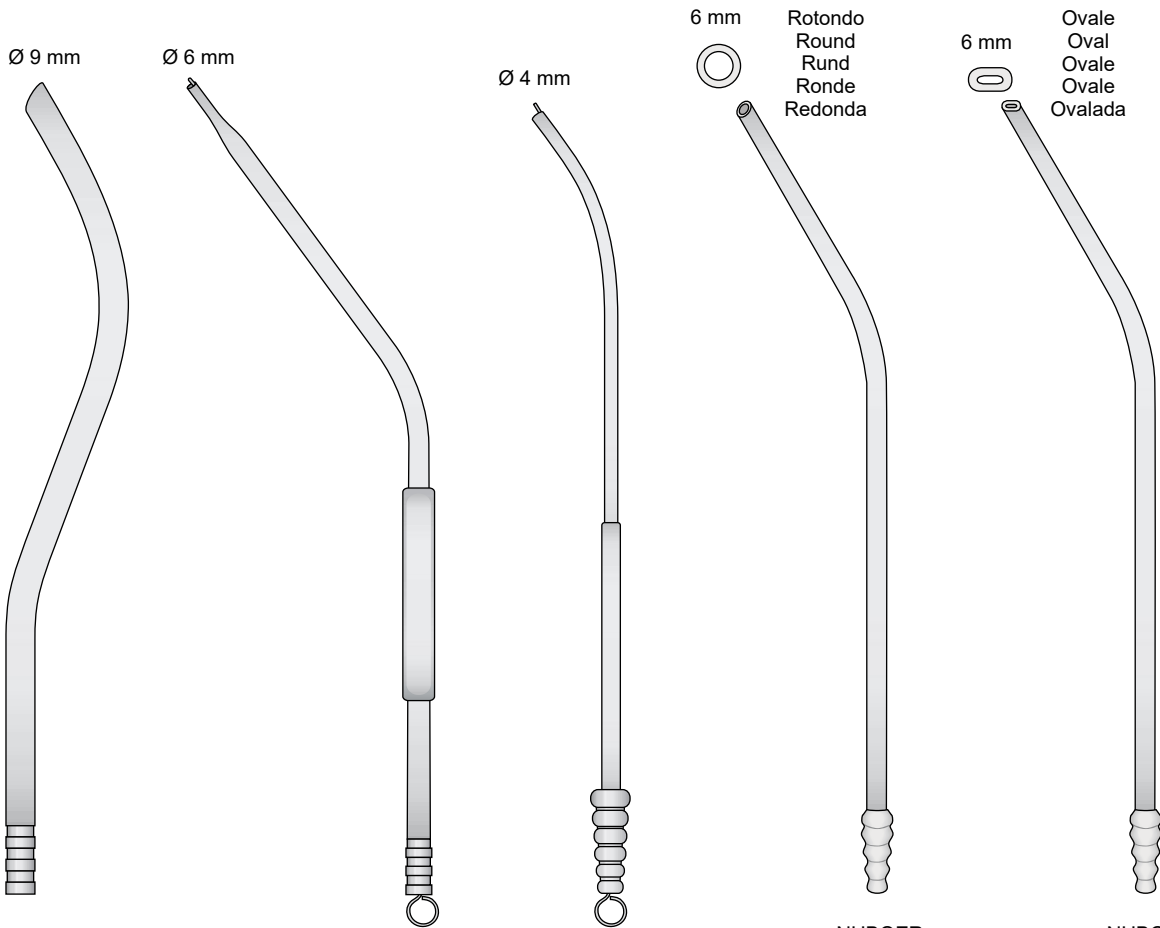

ST 2279-23 23 cm

ST 2280-23 23 cm

ST 2281-24 24 cm

NUBOER
ST 2282-21 21 cm

NUBOER
ST 2283-21 21 cm



Raschietti



GORNEY
ST 2284-18 18 cm



GORNEY
ST 2285-20 20 cm

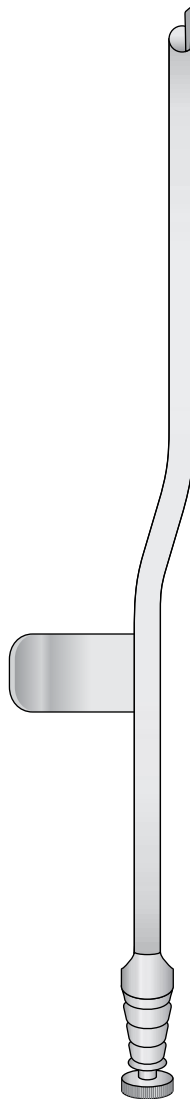

SAUG-RASPATORIUM
ST 2286-01 Ø 4 mm
ST 2286-02 Ø 5 mm

20 cm

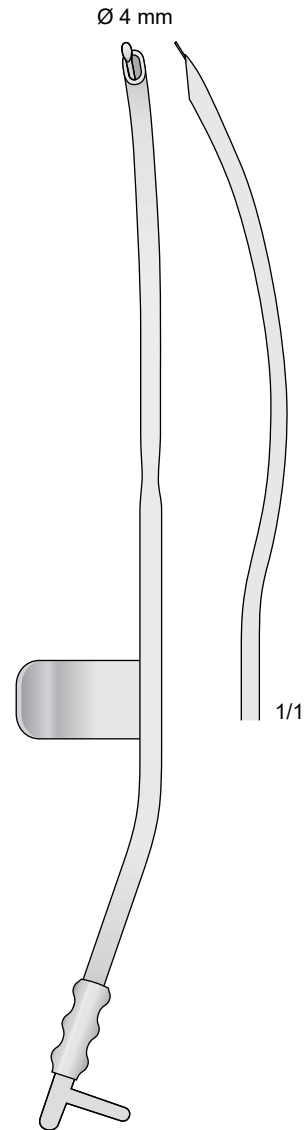

GUILLIEN
ST 2287-20 20 cm

Canule per aspirazion
 Suctions tube
 Absaugkanüle
 Canules aspiratrice
 Cànulas aspiradoras

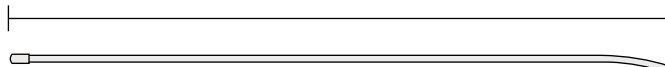

YASARGIL

Code	Usable length	Ø
ST 2288-13	13 cm	1.5 mm
ST 2288-15	15 cm	1.5 mm
ST 2288-18	18 cm	1.5 mm
ST 2288-22	22 cm	1.5 mm

Code	Usable length	Ø
ST 2289-13	13 cm	2.0 mm
ST 2289-15	15 cm	2.0 mm
ST 2289-18	18 cm	2.0 mm
ST 2289-22	22 cm	2.0 mm

Code	Usable length	Ø
ST 2290-13	13 cm	2.5 mm
ST 2290-15	15 cm	2.5 mm
ST 2290-18	18 cm	2.5 mm
ST 2290-22	22 cm	2.5 mm

Code	Usable length	Ø
ST 2291-13	13 cm	3.5 mm
ST 2291-15	15 cm	3.5 mm
ST 2291-18	18 cm	3.5 mm
ST 2291-22	22 cm	3.5 mm

Code	Usable length	Ø
ST 2292-18	18 cm	4.5 mm

YASARGIL

ST 2288-13 / ST 2292-18

Nasensauger

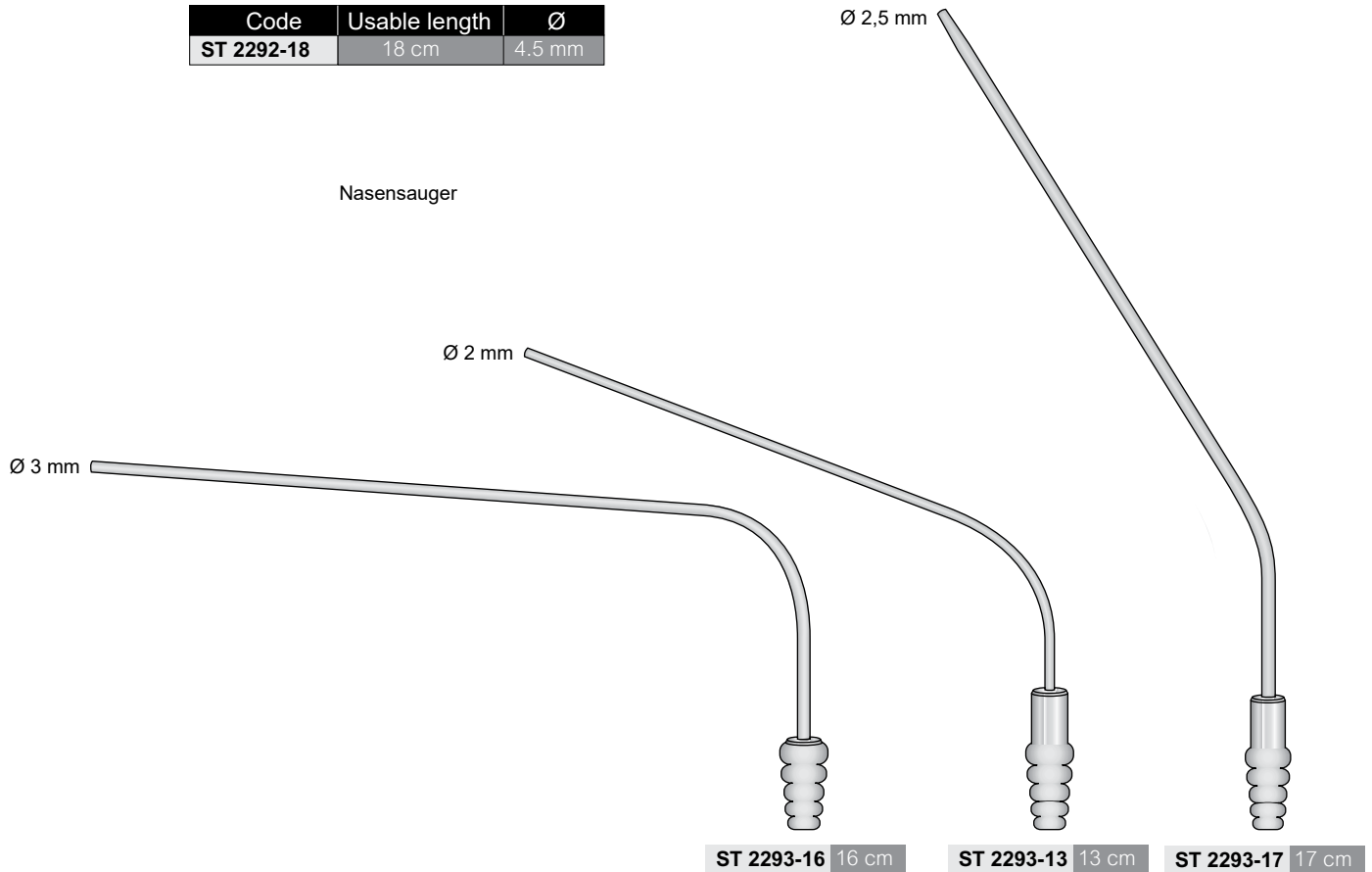

ST 2293-16 16 cm

ST 2293-13 13 cm

ST 2293-17 17 cm

Char. 6	= 2 mm
Char 7	= 2,5 mm
Char 9	= 3 mm
Char 10	= 3,3 mm
Char 12	= 4 mm
Char 15	= 5 mm

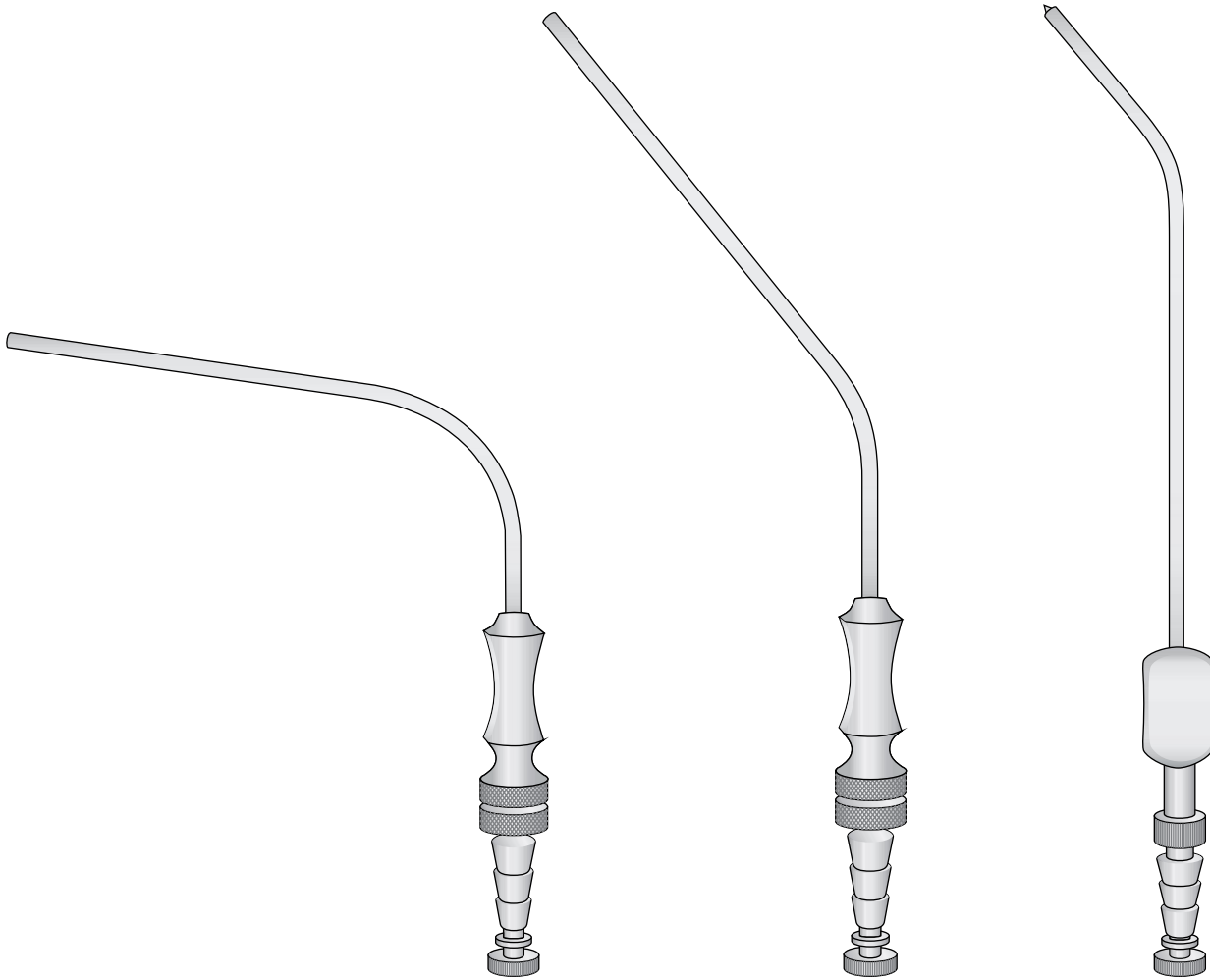

FERGUSON 18 cm

Code	Size
ST 2294-6	ch.6 - 18 cm
ST 2294-7	ch.7 - 18 cm
ST 2294-9	ch.9 - 18 cm
ST 2294-12	ch.12 - 18 cm
ST 2294-15	ch.15 - 18 cm

FRAZIER 18 cm

Code	Size
ST 2295-6	ch.6 - 18 cm
ST 2295-7	ch.7 - 18 cm
ST 2295-9	ch.9 - 18 cm
ST 2295-12	ch.12 - 18 cm
ST 2295-15	ch.15 - 18 cm

PLESTER 20 cm

Code	Size
ST 2296-6	ch.6 - 20 cm
ST 2296-7	ch.7 - 20 cm
ST 2296-9	ch.9 - 20 cm
ST 2296-12	ch.12 - 20 cm
ST 2296-15	ch.15 - 20 cm

Canule per aspirazione
Suctions tube
Absaugkanüle
Canules aspiratrice
Cânulas aspiradoras

Char. 3	= 1 mm
Char 5	= 1,7 mm
Char 7	= 2,5 mm
Char 10	= 3,3 mm
Char 12	= 4 mm

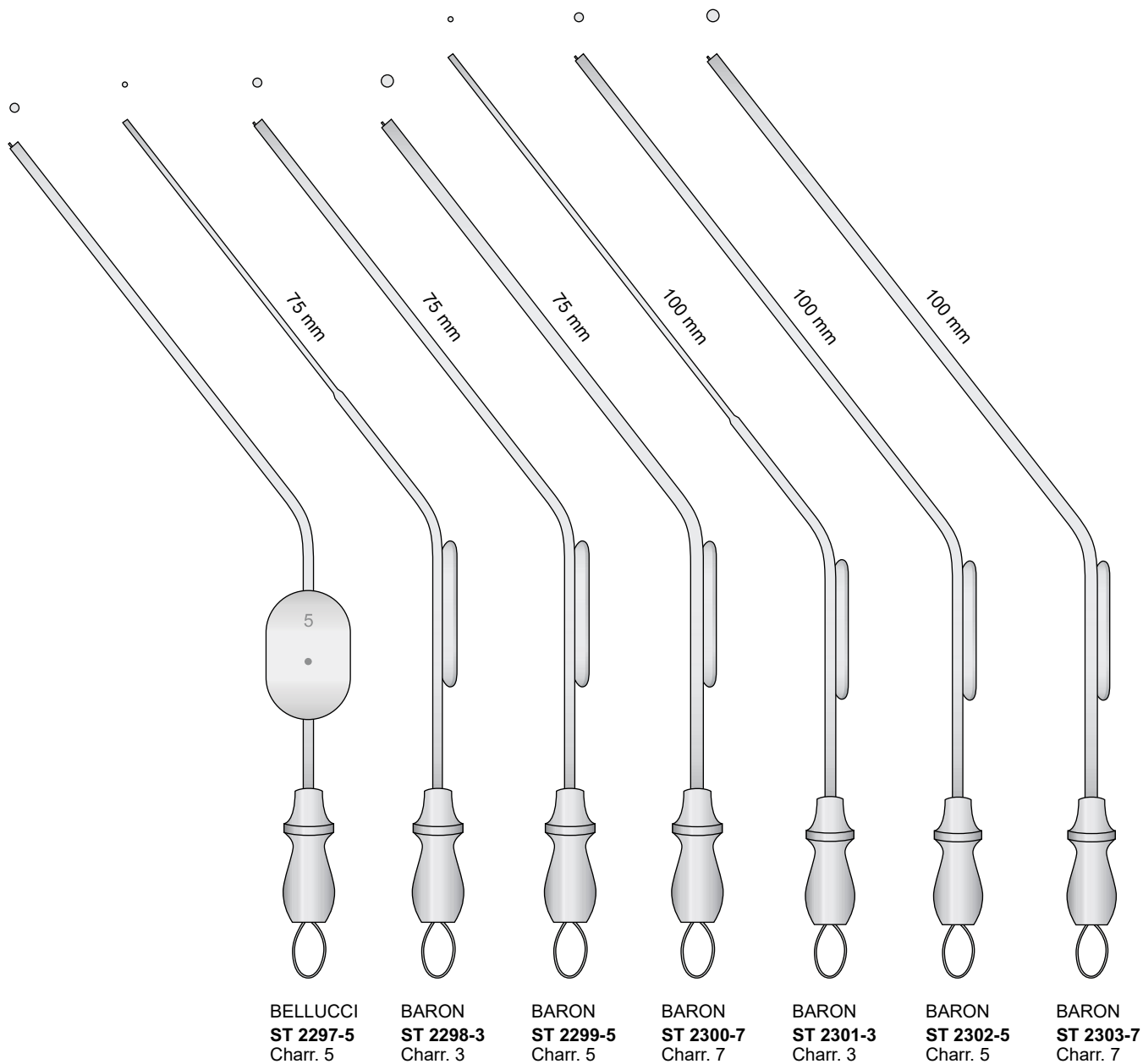

Char. 3	= 1 mm
Char 5	= 1,7 mm
Char 7	= 2,5 mm
Char 10	= 3,3 mm
Char 12	= 4 mm

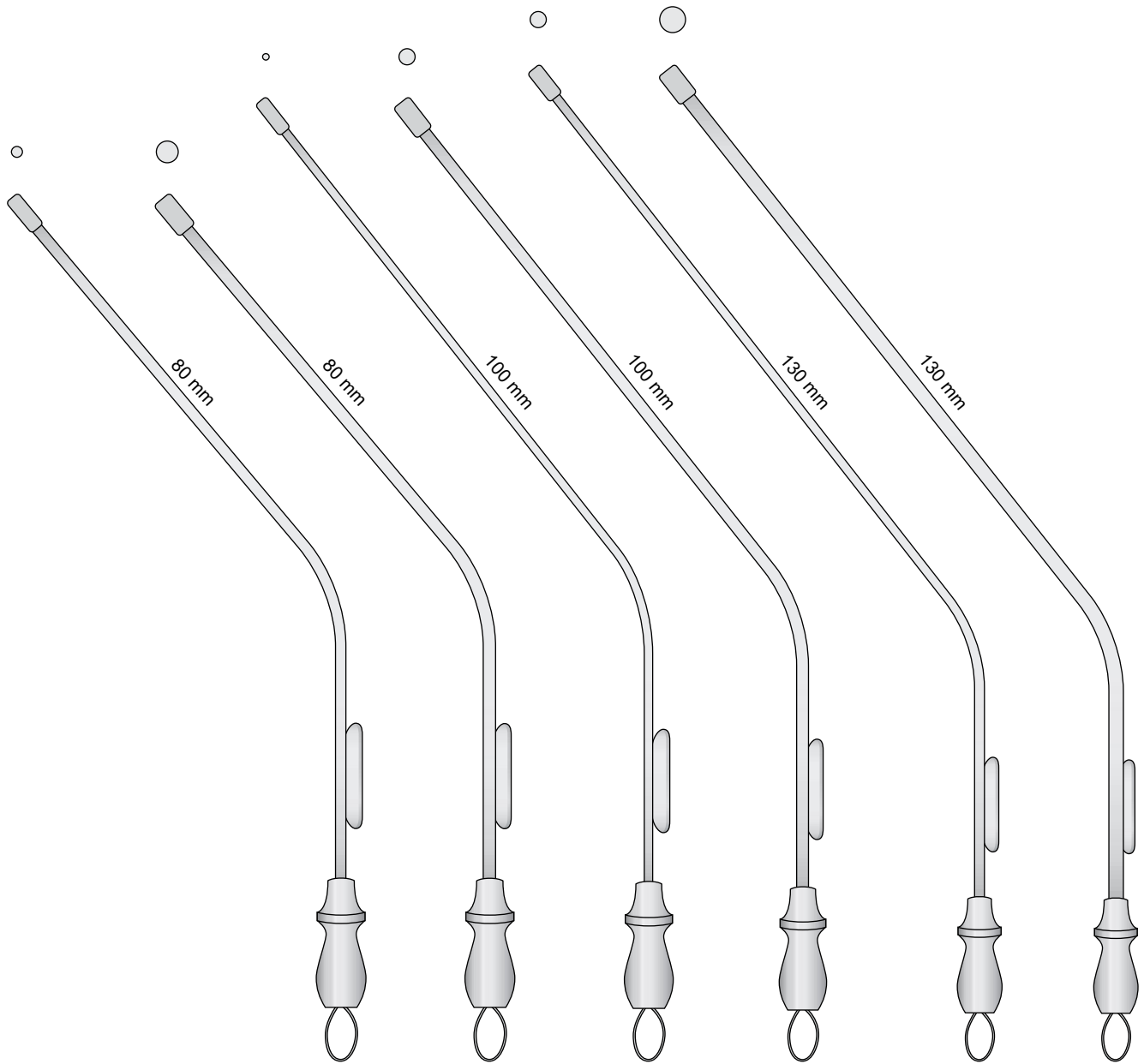

ROTAN
ST 2304-5
Charr. 5

ROTAN
ST 2305-10
Charr. 10

ROTAN
ST 2306-3
Charr. 3

ROTAN
ST 2307-7
Charr. 7

ROTAN
ST 2308-7
Charr. 7

ROTAN
ST 2309-12
Charr. 12

Canule per aspirazione
Suctions tube
Absaugkanüle
Canules aspiratrice
Cànulas aspiradoras

Char. 3	= 1 mm
Char 5	= 1,7 mm
Char 7	= 2,5 mm
Char 10	= 3,3 mm
Char 12	= 4 mm
Char 14	= 4,6 mm

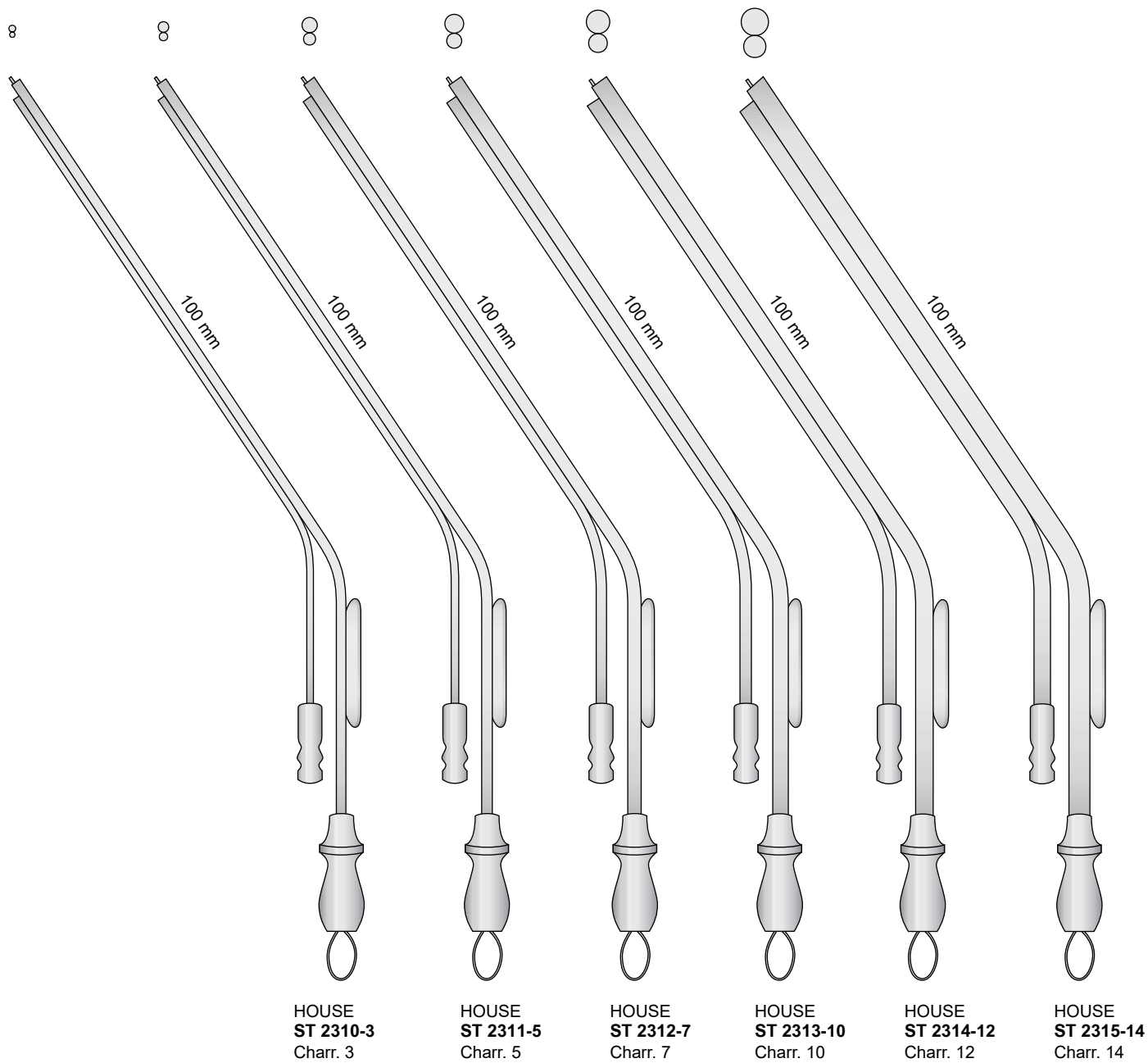

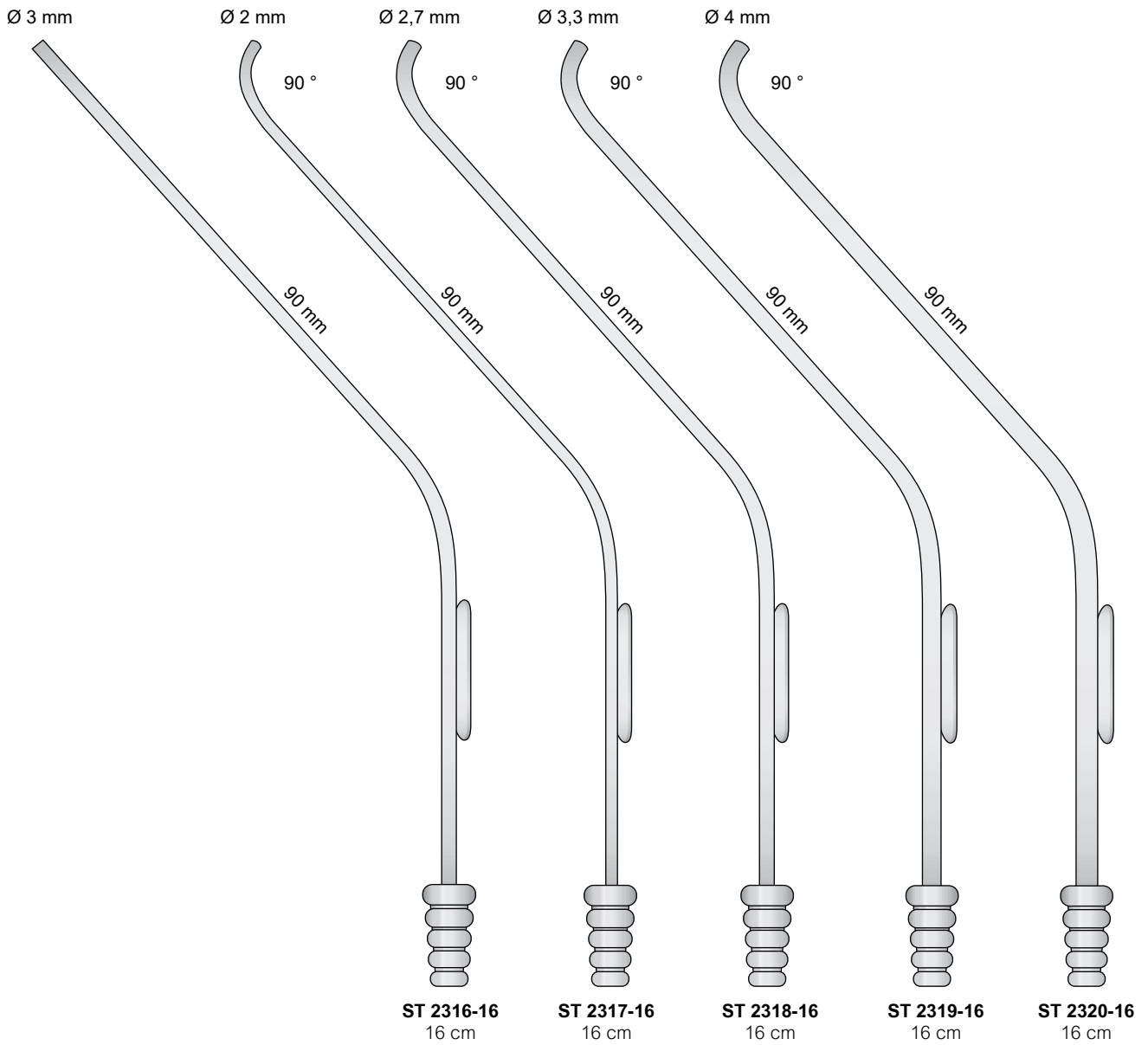

Canule per aspirazione
 Suctions tube
 Absaugkanüle
 Canules aspiratrice
 Cànulas aspiradoras

Cromata nera

Malleabile
 Malleable
 Biègsam
 Mallèables
 Malleable
 Ø 3 mm

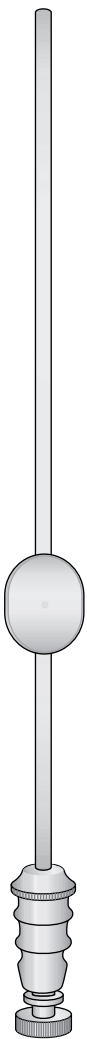

WERTHEIMER

ST 2321-16 16 cm

Malleabile
 Malleable
 Biègsam
 Mallèables
 Malleable
 Ø 3 mm

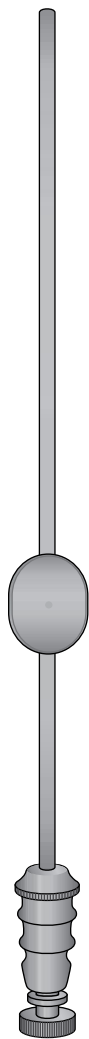

FRAZIER

ST 2322-16 16 cm

Malleabile
 Malleable
 Biègsam
 Mallèables
 Malleable
 Ø 3 mm

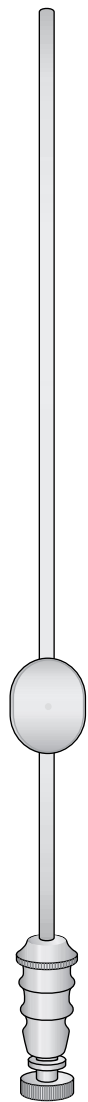

WERTHEIMER

ST 2323-20 20 cm

Cromata nera

Malleabile
 Malleable
 Biègsam
 Mallèables
 Malleable
 Ø 3 mm

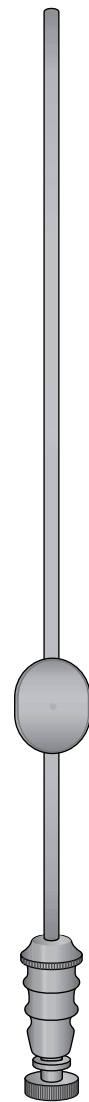

FRAZIER

ST 2324-20 20 cm

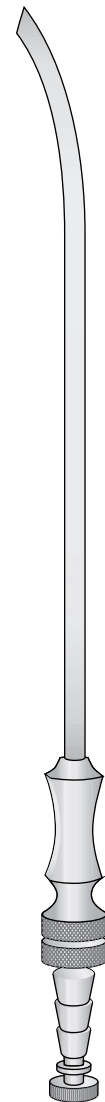

ADSON 21 cm

ST 2325-01 ch. 12

ST 2325-02 ch. 15

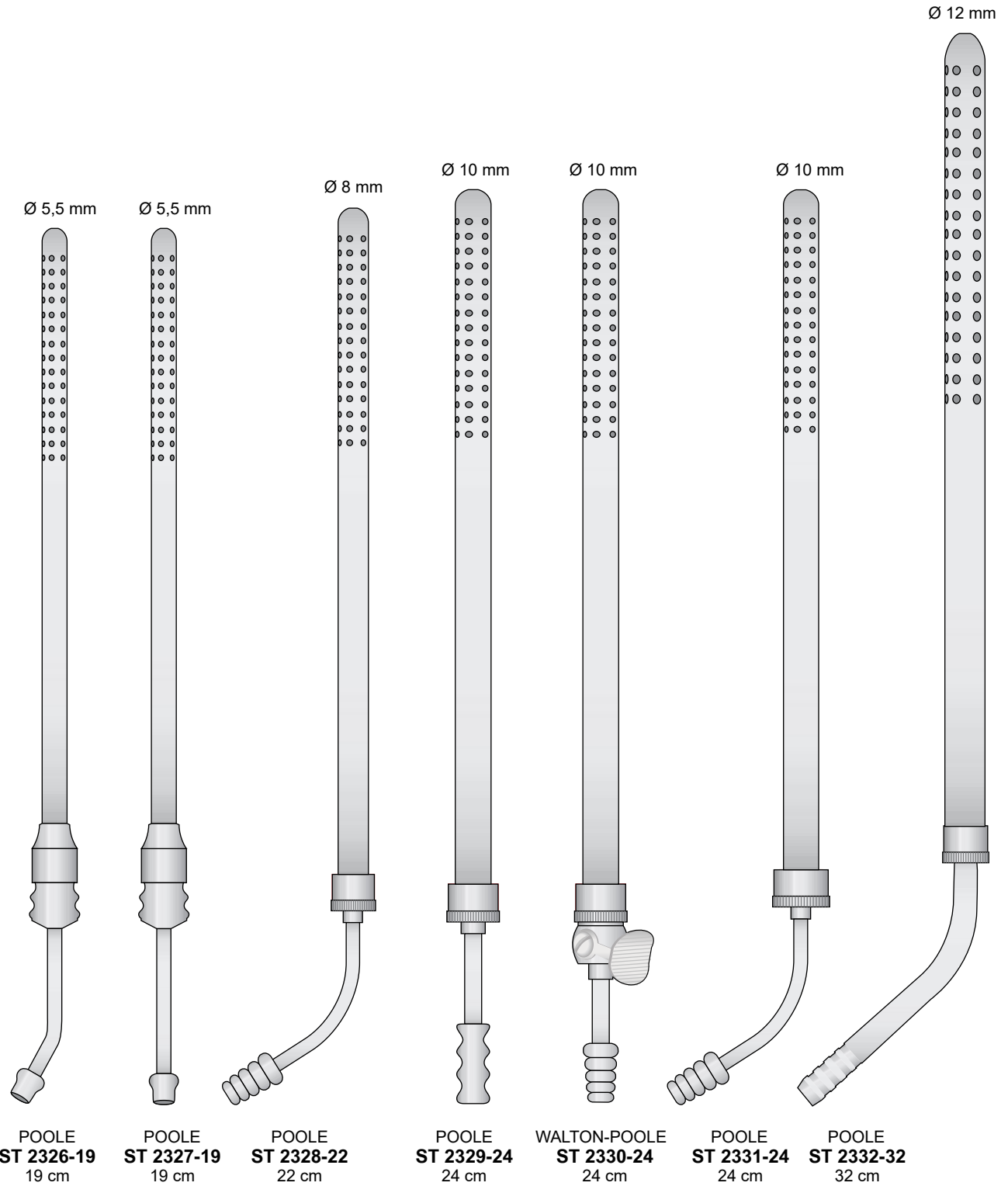

Canule per aspirazione
 Suctions tube
 Absaugkanüle
 Canules aspiratrice
 Cànulas aspiradoras

ST 2339
 Set completo con:
 Set complete with:
 Kompletset mit:
 Set complet avec:
 Set completos con:

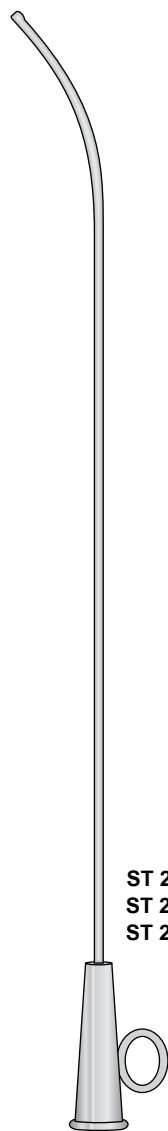

ST 2333-01 - Ø 1,5 mm
ST 2333-02 - Ø 2 mm
ST 2333-03 - Ø 2,5 mm

HARTMANN

ST 2333-17 17 cm

Ø 4 mm

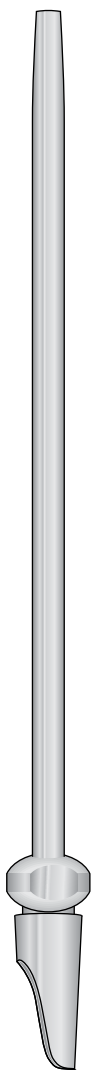

ST 2334-16 16 cm

Ø 4 mm

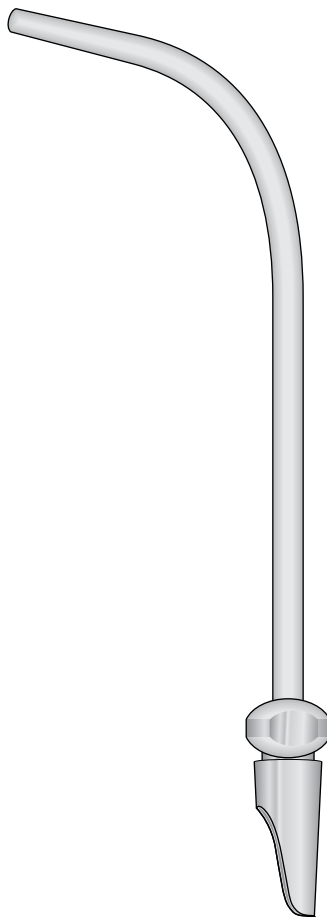

ST 2335-14 14.5 cm

Pompetta in plastica

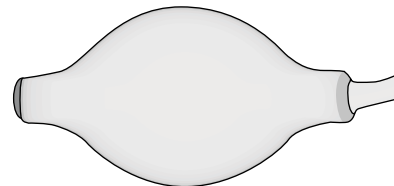

ST 2338

Raccordo in silicone per canule
 Autoclavabile

2 mt.

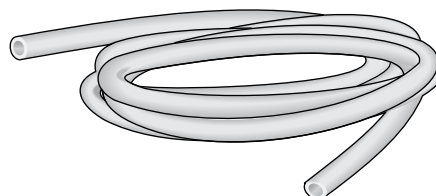

ST 2337
 2 mt.

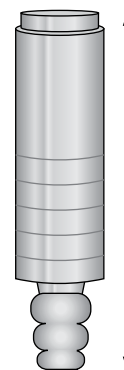

65 mm

ST 2336-06 6.5 cm

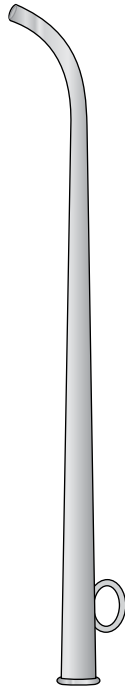

Code	Size
ST 2340-01	Ø 3,0 mm
ST 2340-02	Ø 3,5 mm
ST 2340-03	Ø 4,0 mm
ST 2340-04	Ø 4,5 mm
ST 2340-05	Ø 5,0 mm

ITARD

ST 2340-01 / ST 2340-05

14.5 cm

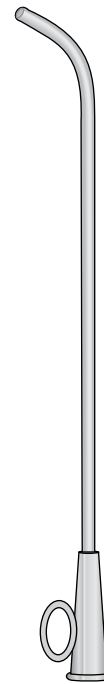

ST 2342

Code	Size
ST 2341-01	Ø 2,0 mm
ST 2341-02	Ø 2,5 mm
ST 2341-03	Ø 3,0 mm
ST 2341-04	Ø 3,5 mm
ST 2341-05	Ø 4,0 mm
ST 2341-06	Ø 4,5 mm
ST 2341-07	Ø 5,0 mm

HARTMANN

ST 2341-01 / ST 2341-07

15 cm

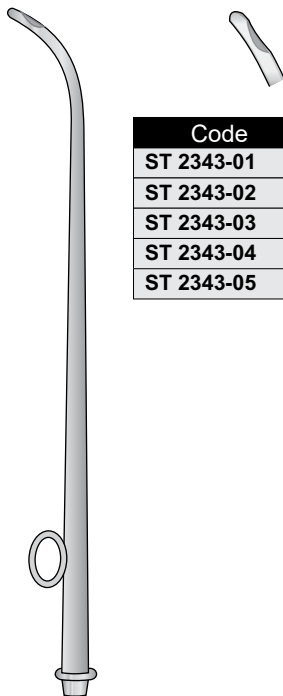

Code	Size
ST 2343-01	Ø 1,5 mm
ST 2343-02	Ø 1,7 mm
ST 2343-03	Ø 2,0 mm
ST 2343-04	Ø 2,5 mm
ST 2343-05	Ø 3,0 mm

SIEBENMANN

ST 2343-01 / ST 2343-05

15 cm

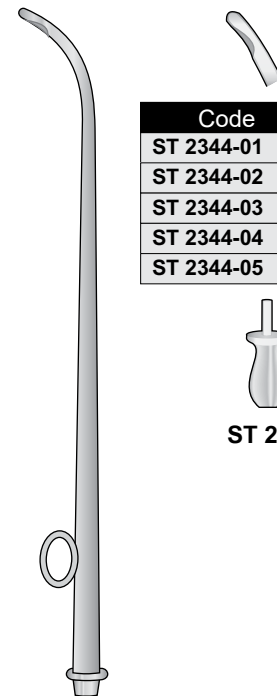

Code	Size
ST 2344-01	Ø 1,5 mm
ST 2344-02	Ø 1,7 mm
ST 2344-03	Ø 2,0 mm
ST 2344-04	Ø 2,5 mm
ST 2344-05	Ø 3,0 mm



ST 2345

SIEBENMANN

ST 2344-01 / ST 2344-05

15 cm

Canule per aspirazione
 Suctions tube
 Absaugkanüle
 Canules aspiratrice
 Cànulas aspiradoras

Ø Interno
 Ø Inside
 Ø Innen
 Ø Intérieur
 Ø Interior

Ø Interno
 Ø Inside
 Ø Innen
 Ø Intérieur
 Ø Interior

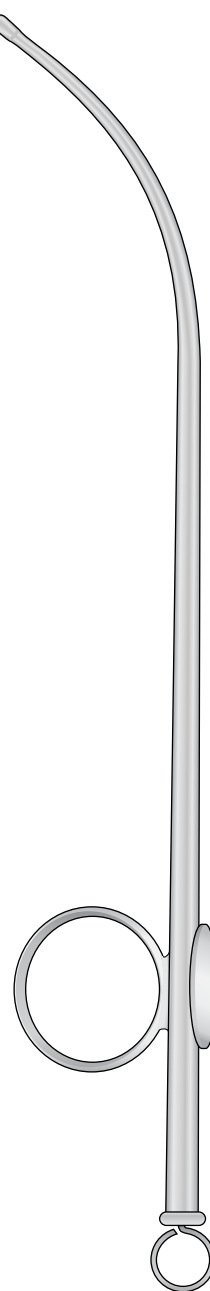
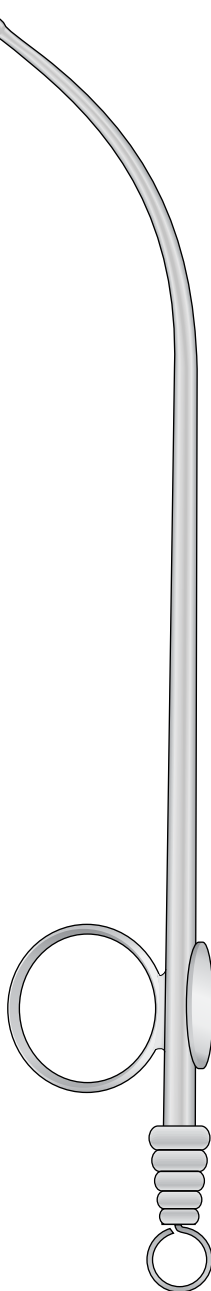
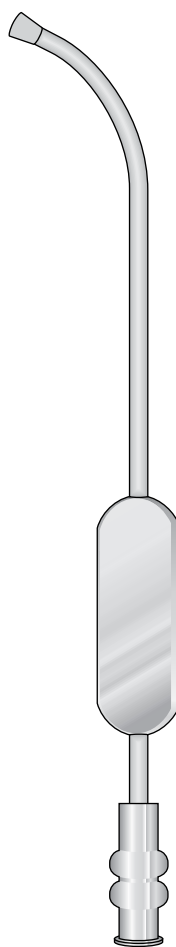
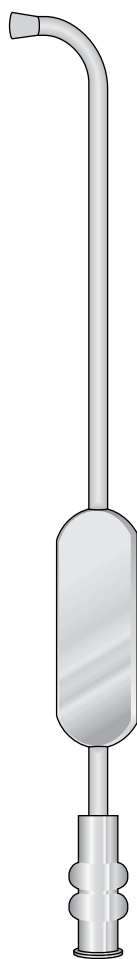

KILLIAN 14.5 cm

ST 2346-01 Ø 3 mm
ST 2346-01 Ø 4 mm

KILLIAN 14.5 cm

ST 2347-01 Ø 3 mm
ST 2347-01 Ø 4 mm

MAGILL 20 cm

ST 2348-01 Ø 1 mm

MAGILL 20 cm

ST 2349-01 Ø 1 mm
ST 2349-02 Ø 2 mm
ST 2349-03 Ø 3 mm

Steriliser bar
Autoclavable
Autoclavabile
Esterilizabile
Stérilisable

Handwaschbürste
Nail brush
Spazzola per unghie
Cepillo de uñas
Brosse à ongles



ST 2350 4 X 11 cm

Scovolini per pulizia canule
Kanülenreinigungs-bürsten

Ø Est. 8 mm
Ø Int. 6 mm

Ø Est. 5 mm
Ø Int. 2,5 mm

1/1

1/1

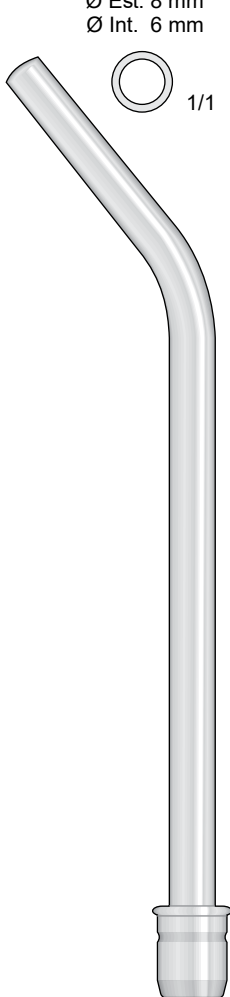

PELTON-CRANE
ST 2351-14
14 cm

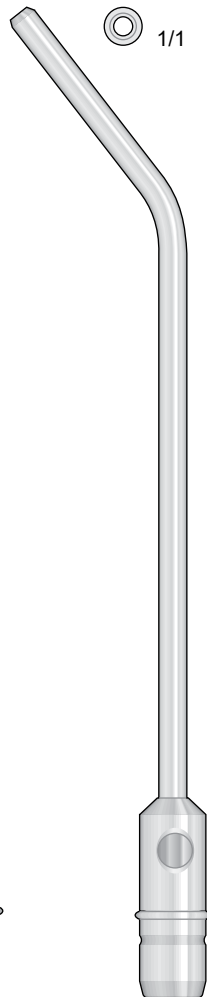

PELTON-CRANE
ST 2352-16
16 cm

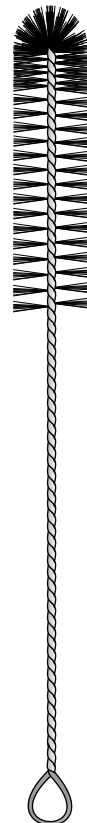

ST 2353-12
12 cm



ST 2354-23
23.5 cm

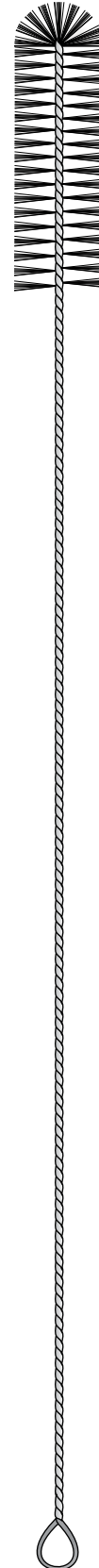

ST 2355-33
33 cm

Canule per aspirazion
 Suctions tube
 Absaugkanüle
 Canules aspiratrice
 Cànulas aspiradoras

Sonde per varici, malleabili - Probe for varicose veins, malleable
 Krampfadersonden, biegsam - Sondes pour varices, malléables
 Sondas para vârices, maleables

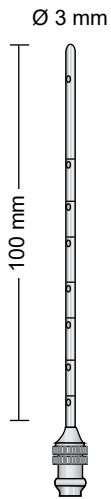

FRAZIER
 ST 2356

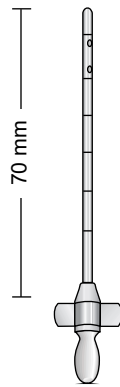

Code	Size
ST 2357-01	Ø 2 mm
ST 2357-02	Ø 2,5 mm

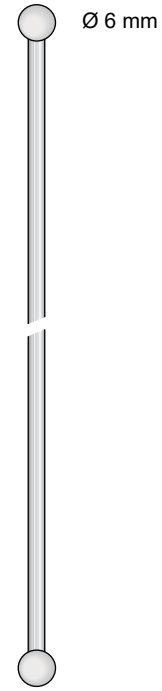

BABCOCK

Code	Size
ST 2358-40	400 mm
ST 2358-50	500 mm
ST 2358-65	650 mm
ST 2358-80	800 mm

Aghi per tonsille
 Tonsil needles
 Tonsillenkantülen
 Aiguilles pour les amygdales
 Agujas para amigdalas



ST 2359-12
 120 mm

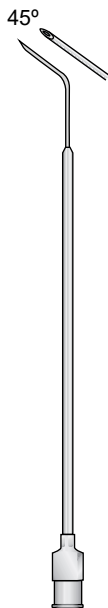

ST 2360-11
 110 mm



ST 2361-11
 110 mm

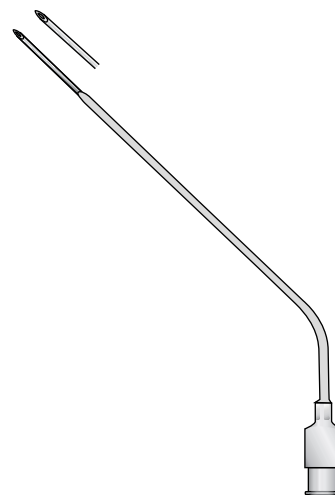

SEPTUN-NADEL
 ST 2362-11
 110 mm

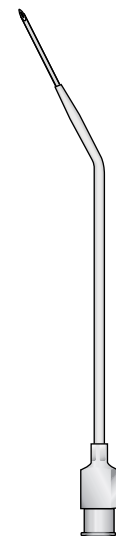

ST 2363-11
 110 mm

Ø 1 mm

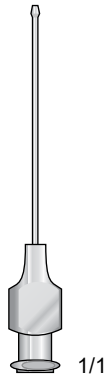

ST 2364-05
50 mm

Ø 2 mm

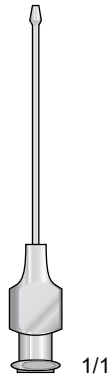

ST 2365-05
50 mm

Ø 3 mm

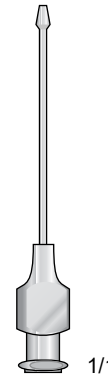

ST 2366-05
50 mm

Canule per irrigazione dei vasi, malleabili
Vessel irrigating cannulas, malleable
Gefäß-spülkanülen, biegsam
Canules d'irrigation pour vaisseaux, malléables
Cànulas de irrigacion para vasos, maleables

Ø 3 mm Ø 4 mm Ø 5 mm Ø 6 mm

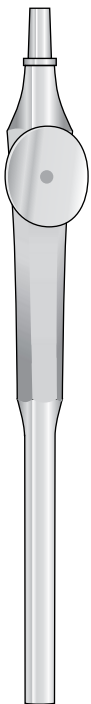

LUER-LOCK
ST 2364-12
12 cm

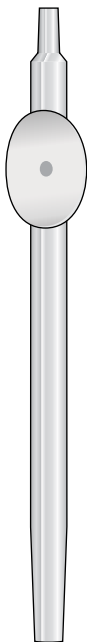

ST 2365-11
11 cm



LUER-LOCK
ST 2366-06
6.5 cm

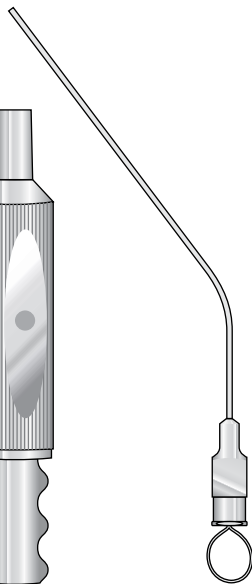

ROSEN 9.5 cm
ST 2367-01 Ø 0,70 mm
ST 2367-02 Ø 0,90 mm
ST 2367-03 Ø 1,25 mm



ROSEN 9.5 cm
ST 2368-01 Ø 0,70 mm
ST 2368-02 Ø 0,90 mm
ST 2368-03 Ø 1,25 mm



SCHMID
ST 2369-15
15 cm



SCHMID
ST 2370-15
15 cm



SCHMID
ST 2371-15
15 cm

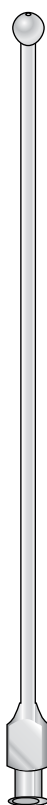

SCHMID
ST 2372-15
15 cm

Canule per aspirazione
 Suctions tube
 Absaugkanüle
 Canules aspiratrice
 Cànulas aspiradoras

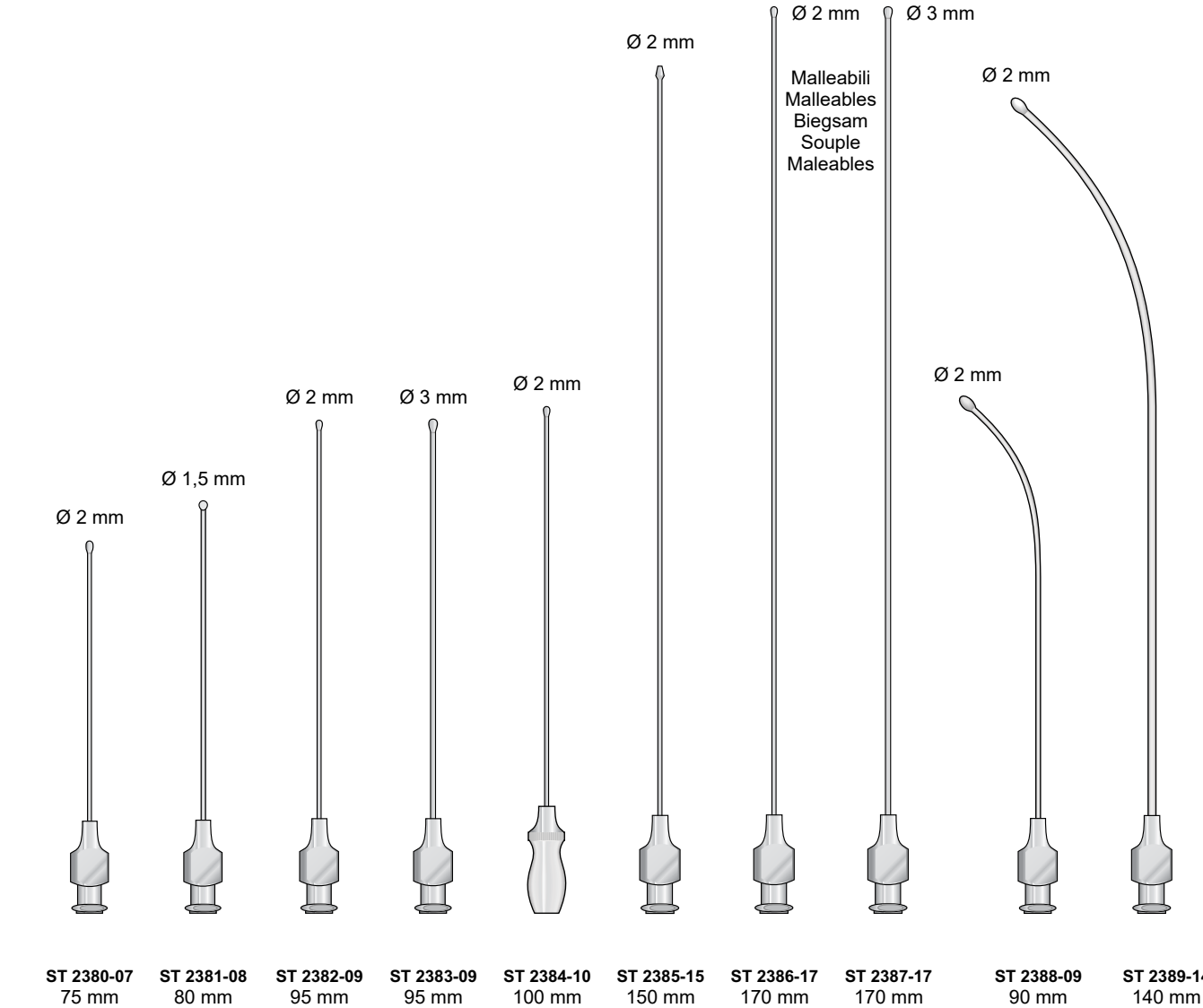
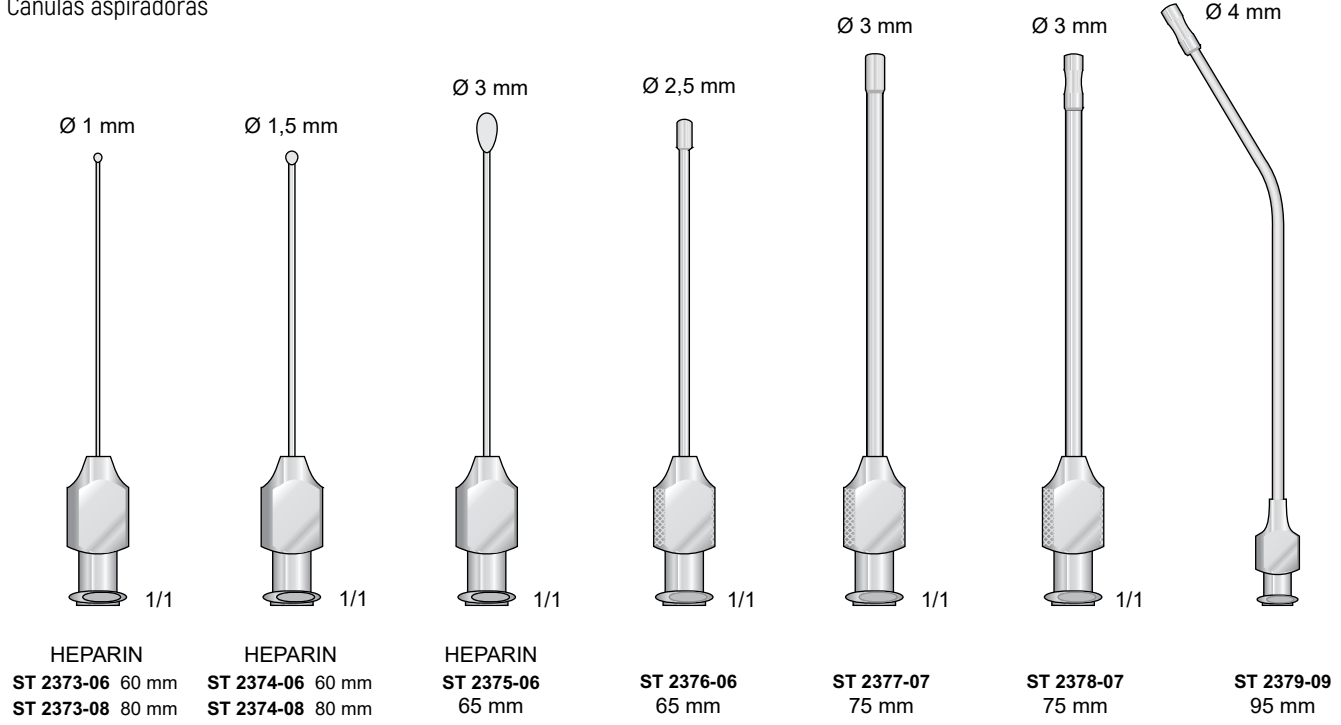

Aghi malleabili

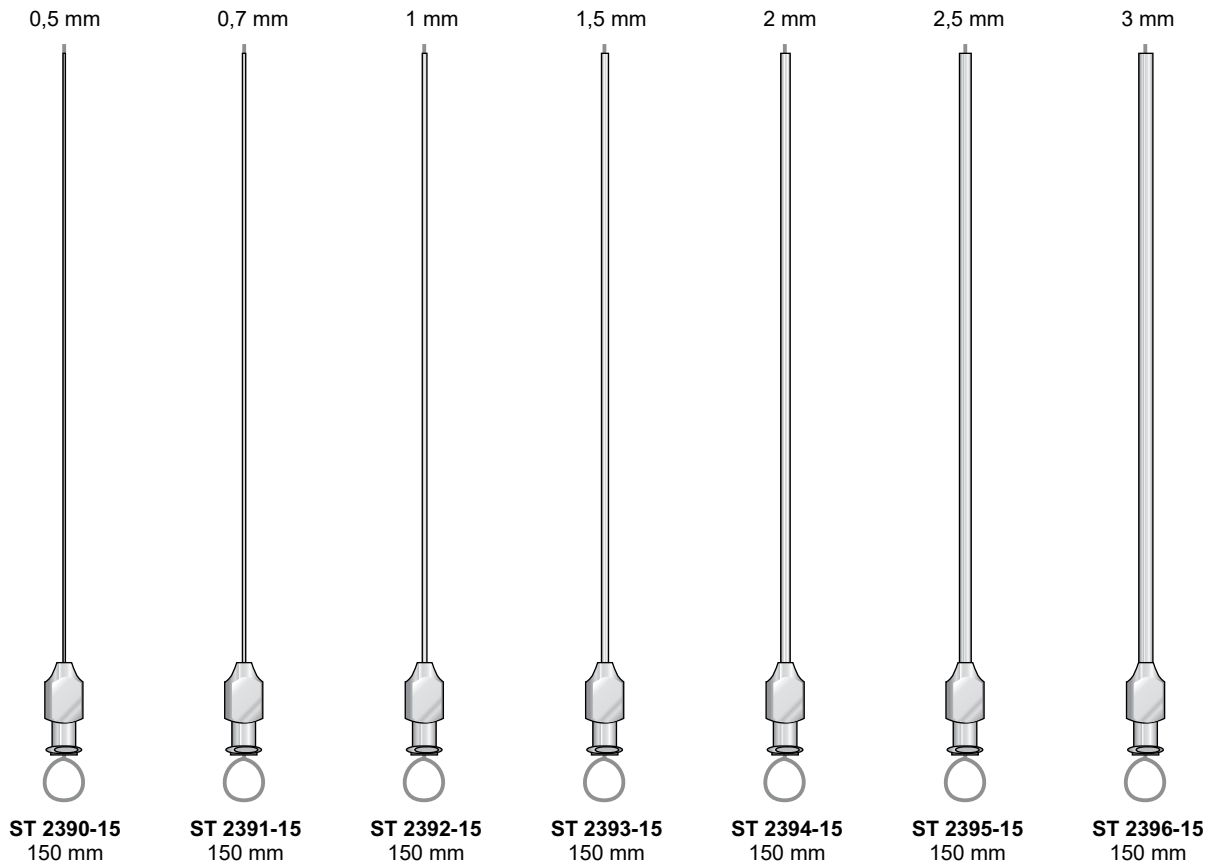

Aghi malleabili con due fori

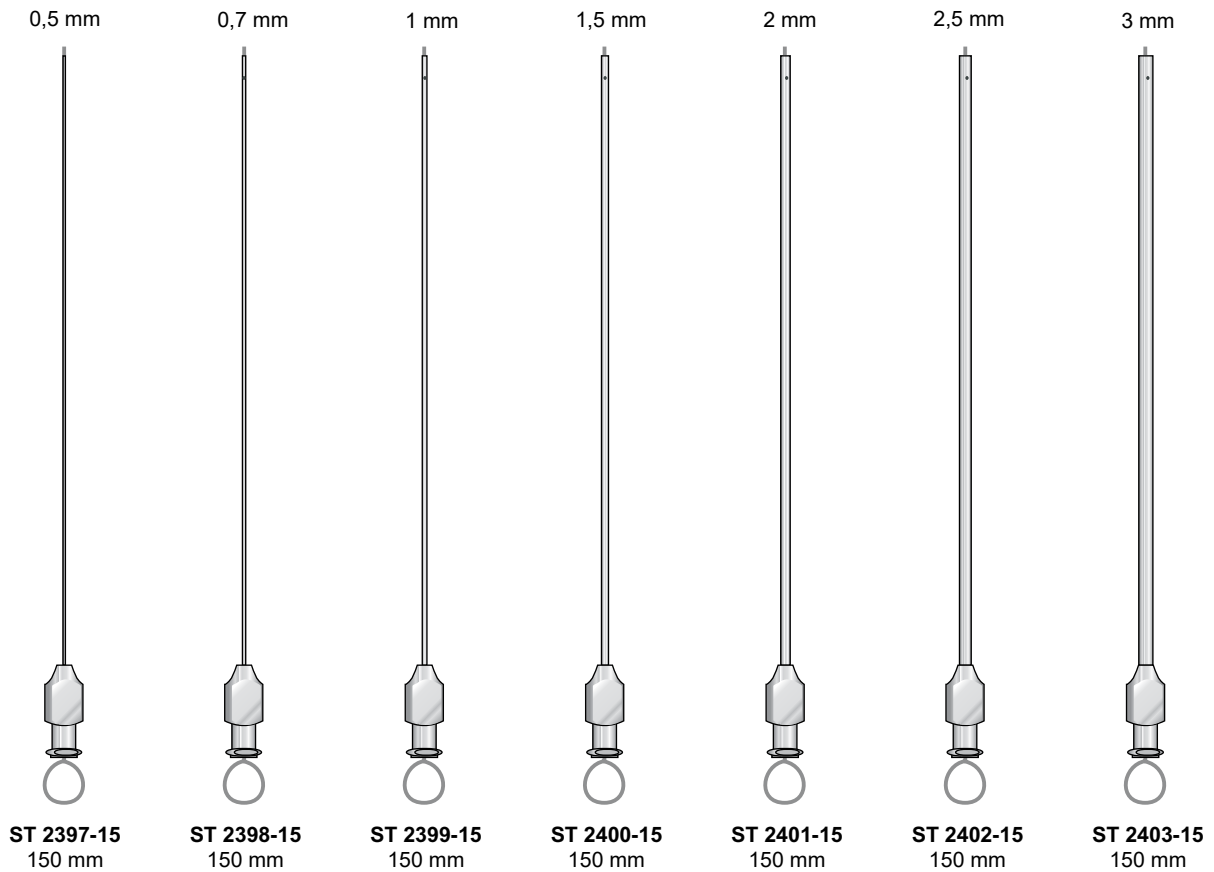

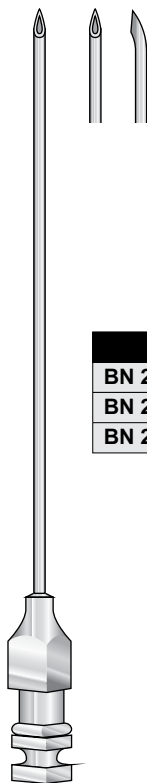

Code	Size
BN 2404-01	1,30 x 80 mm
BN 2404-02	1,50 x 80 mm
BN 2404-03	1,65 x 80 mm

TUOHY

BN 2404-01 / BN 2404-03



Code	Size
BN 2405-01	0,70 x 80 mm
BN 2405-02	0,70 x 90 mm
BN 2405-03	1,00 x 80 mm
BN 2405-04	1,00 x 90 mm
BN 2405-05	1,20 x 90 mm
BN 2405-06	1,20 x 100 mm

QUINCKE

BN 2405-01 / BN 2405-06

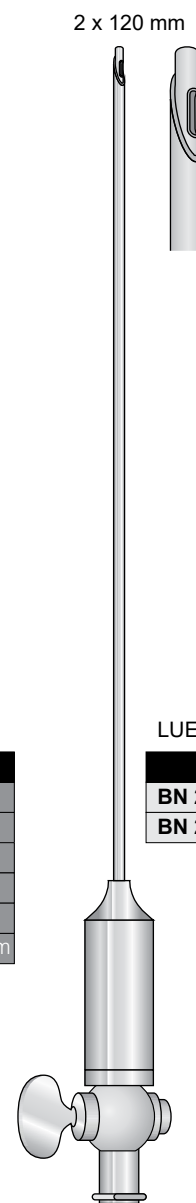

LUER LOCK

Code	Size
BN 2406-01	12 cm
BN 2406-02	15 cm

VERRES

BN 2406-01 / BN 2406-02



we take a closer look



Maintenance and Sterilization



Wartung und Sterilisierung
Entretien et Stérilisation
Mantenimiento y Esterilización
Manutenzione e Sterilizzazione

Scatola per sterilizzazione aghi da sutura - Box for needles
 Sterilbehälter für Nadeln - Boite pour aiguilles de suture
 Estuche para agujas

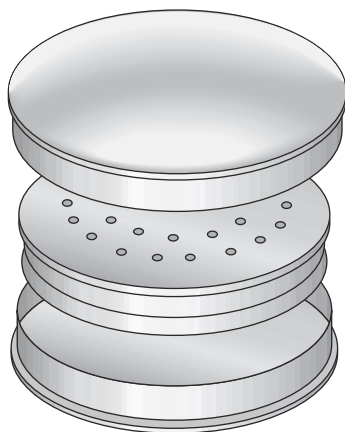

SC 2410 Ø 78 mm h 15 mm

Vaso in vetro con coperchio in acciaio inox
 Jarin glass with lid in stainless steel
 Pot en verre avec couvercle en acier inox

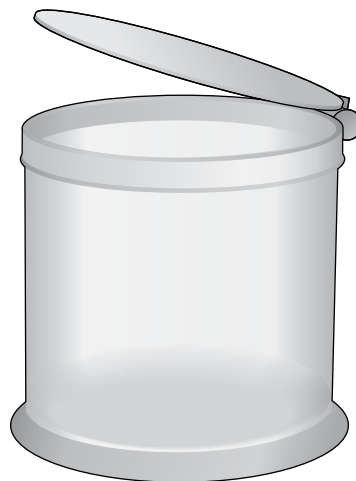

Code	Size
SC 2411-01	Ø 100x100 mm
SC 2411-02	Ø 120x120 mm

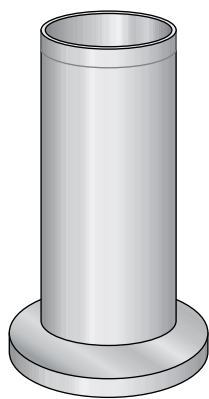

Code	Size
SC 2412-01	Ø 50 mm h 100 mm
SC 2412-02	Ø 50 mm h 150 mm
SC 2412-03	Ø 80 mm h 180 mm

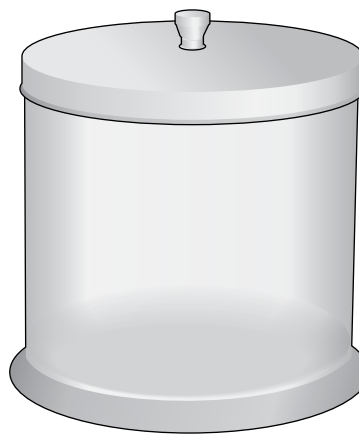

Code	Size
SC 2413-01	Ø 100x100 mm
SC 2413-02	Ø 120x120 mm

Capsule inox con fondo piano e becco
 Lotion bowis capsules
 Runder Sterilbehälter mit Ausguss
 Capsule en acier inox

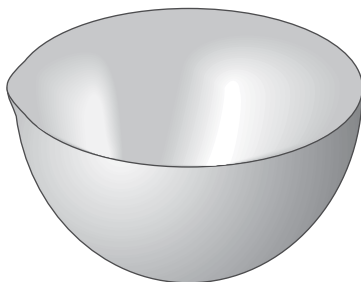

Code	Size
SC 2414-01	Ø 40 mm 15 cc
SC 2414-02	Ø 60 mm 75 cc
SC 2414-03	Ø 80 mm 225 cc
SC 2414-04	Ø 100 mm 325 cc
SC 2414-05	Ø 120 mm 500 cc
SC 2414-06	Ø 150 mm 600 cc

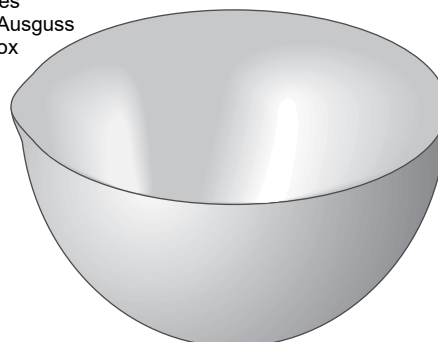

Code	Size
SC 2415-01	Ø 180 mm 1000 cc
SC 2415-02	Ø 200 mm 1450 cc
SC 2415-03	Ø 220 mm 2000 cc
SC 2415-04	Ø 240 mm 3300 cc

Inox - Stainless steel - Rostfrei
Inoxidable

Bacinella a 7 scomparti

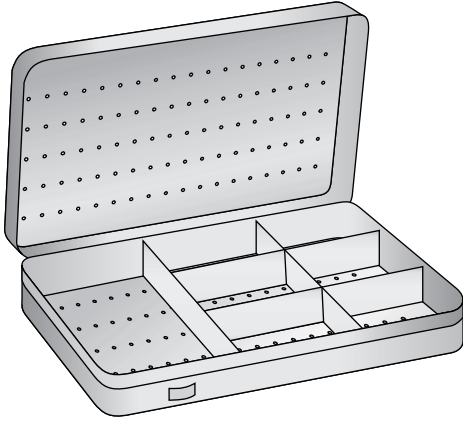

SC 2416 150 x 90 x 20 mm

Bacinella a 3 scomparti

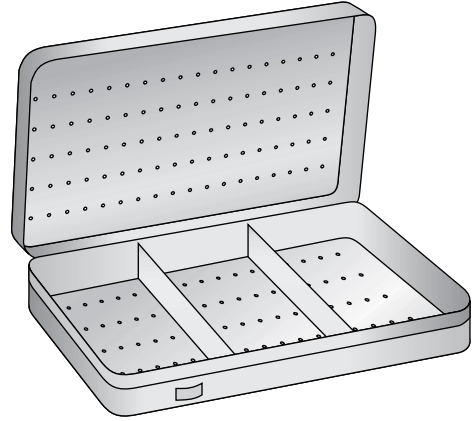

SC 2417 150 x 90 x 20 mm

Bacinella a 10 scomparti

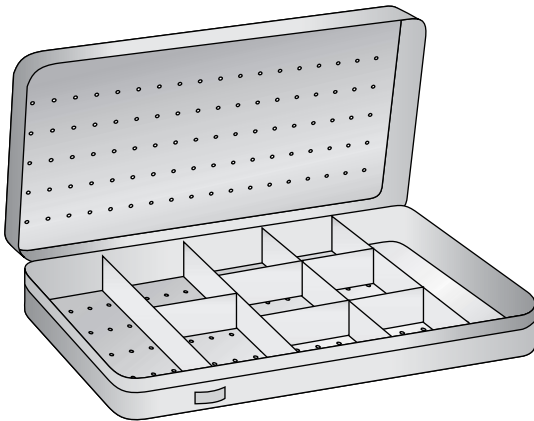

SC 2418 220 x 120 x 20 mm

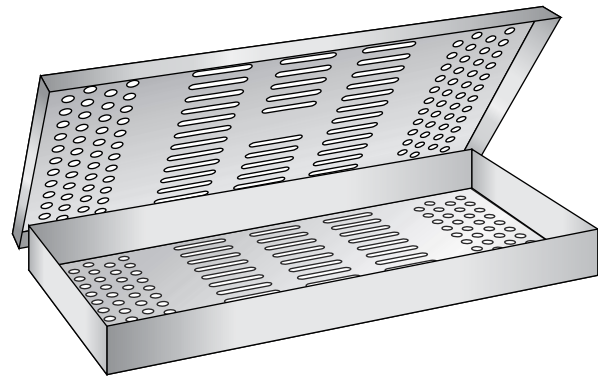

SC 2419 275 x 130 x 25 mm

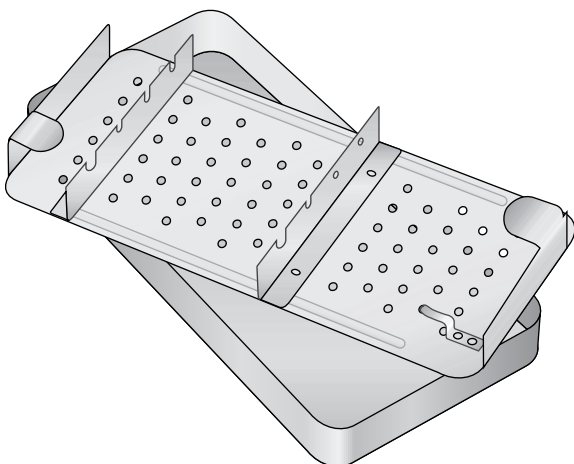

SC 2420 180 x 90 x 35 mm 2 ripiani

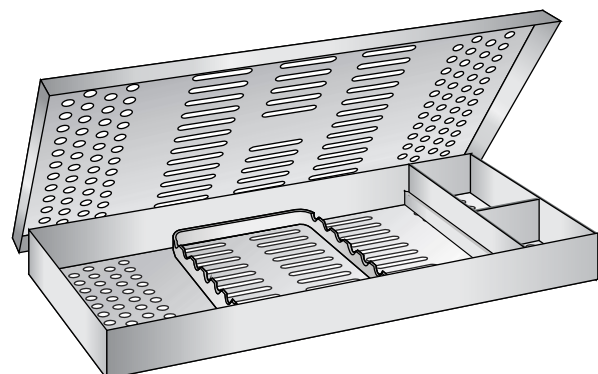

SC 2421-01 275 x 130 x 25 mm Con griglia e scomparti

SC 2421-02 285 x 190 x 25 mm Con griglia e scomparti

Bacinelle reniformi
 Kidney bowls
 Nierenschalen
 Bassins réniformes
 Riñoneras

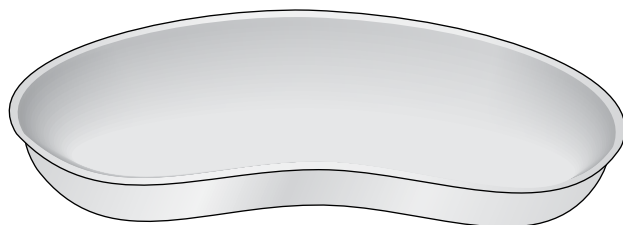

Code	Size
SC 2422-01	20 cm
SC 2422-02	25 cm
SC 2422-03	28 cm

Vassoi porta-strumenti
 Trays
 Schalen
 Bassins
 Bandejas

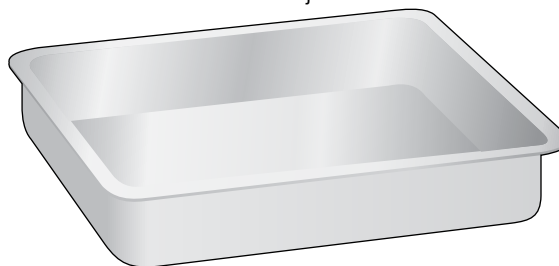

Code	Size
SC 2423-01	210x110x25 mm
SC 2423-02	250x180x30 mm
SC 2423-03	300x220x30 mm

Bacinella in vetro con coperchio e pomolo in acciaio inox
 Container in glass with lid and knob in stainless steel
 Cuvette en verre avec couvercle et pommeau en acier inox

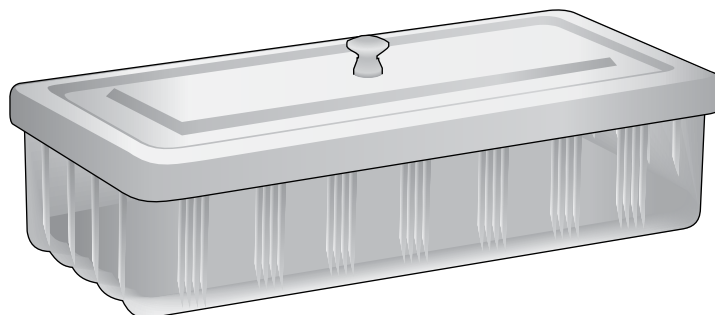

Code	Size
SC 2424-01	140x80x50 mm
SC 2424-02	200x60x40 mm
SC 2424-03	220x100x50 mm
SC 2424-04	220x140x60 mm
SC 2424-05	300x180x65 mm

Scatole per sterilizzazione a secco
 Instrument boxes
 Instrumentenkästen
 Boites pour instruments
 Cajas para instrumentos

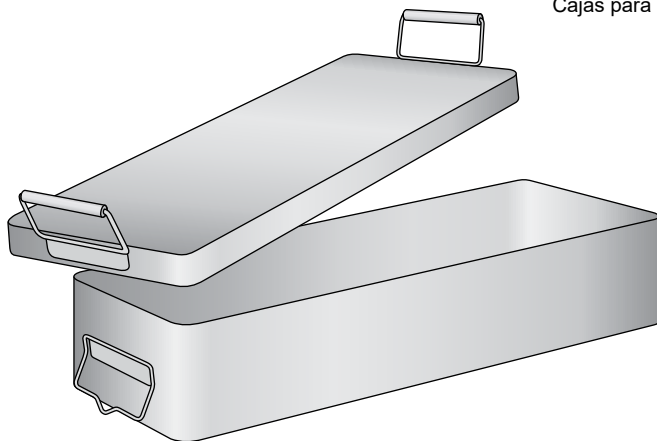

Code	Size
SC 2425-01	280 x 140 x 60 mm
SC 2425-02	300 x 140 x 60 mm
SC 2425-03	360 x 160 x 70 mm

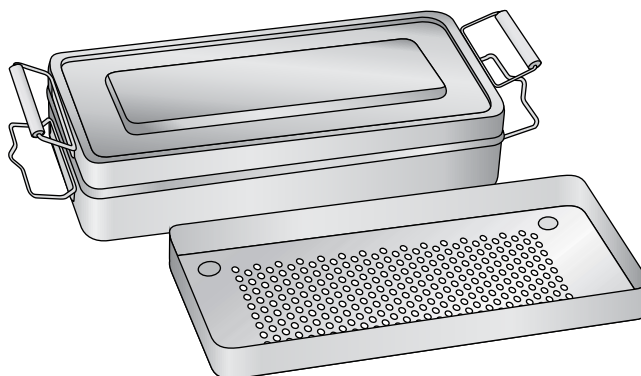

Code	Size
SC 2426-01	150 x 90 x 40 mm
SC 2426-02	200 x 100 x 60 mm
SC 2426-03	250 x 120 x 60 mm
SC 2426-04	280 x 140 x 60 mm
SC 2426-05	320 x 150 x 60 mm

Cestelli rettangolari con filtro
Mit filter
Whith filter
Avec filtre
Con filtros

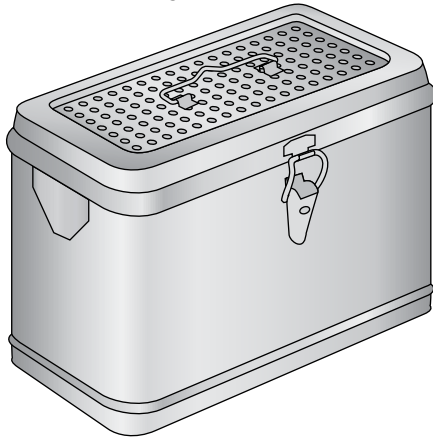

Code	Size
SC 2427-01	200 x 180 x 120 mm
SC 2427-02	200 x 180 x 180 mm
SC 2427-03	250 x 250 x 250 mm
SC 2427-04	270 x 160 x 160 mm
SC 2427-05	290 x 290 x 290 mm
SC 2427-06	350 x 230 x 200 mm

Cestelli cilindrici
Dressing sterilizing drums
Verbandstofftrommeln
Boites à stérilisation
Cajas para esterilización

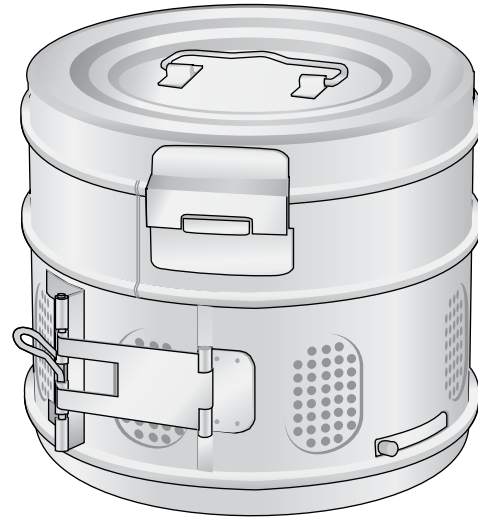

Code	Size
SC 2428-01	125x125 mm
SC 2428-02	150x150 mm
SC 2428-03	190x145 mm
SC 2428-04	290x240 mm

Cestelli rettangolari
Rectengular drum
Panier rectangulaire

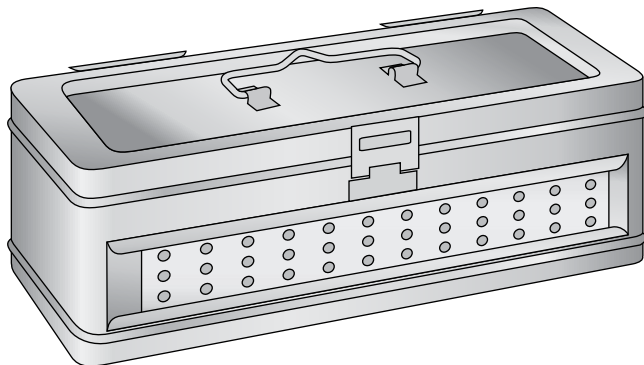

Code	Size
SC 2429-01	300 x 150 x 60 mm
SC 2429-02	300 x 150 x 90 mm
SC 2429-03	300 x 150 x 180 mm

Cestelli rettangolari
Rectengular drum
Panier rectangulaire

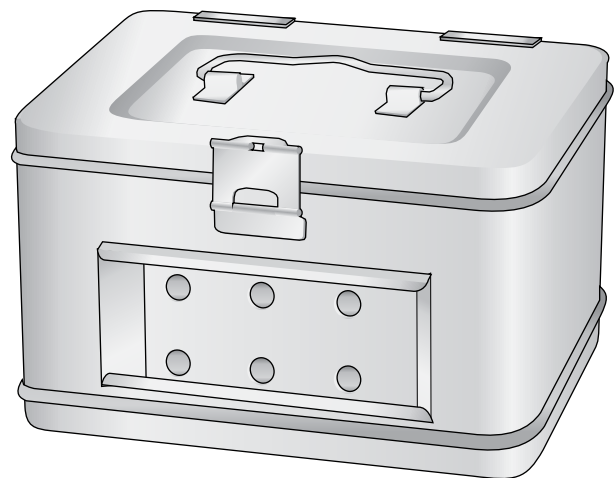

Code	Size
SC 2430-01	190x110x120 mm
SC 2430-02	200x180x120 mm
SC 2430-03	200x180x180 mm
SC 2430-04	250x200x200 mm

Tappeti in aghi di silicon
Silikon matt
Matte en silicon
Tapis en Silicon
Tapete en agujas de silicona

Autoclavabili
Autoclavable
Sterilisierbar

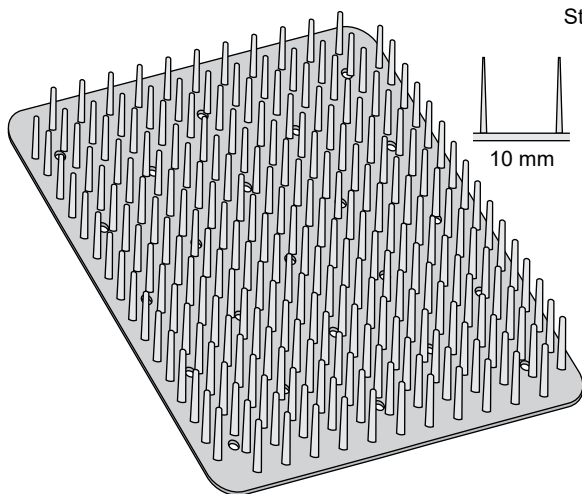

SM 2431 135 x 180 mm

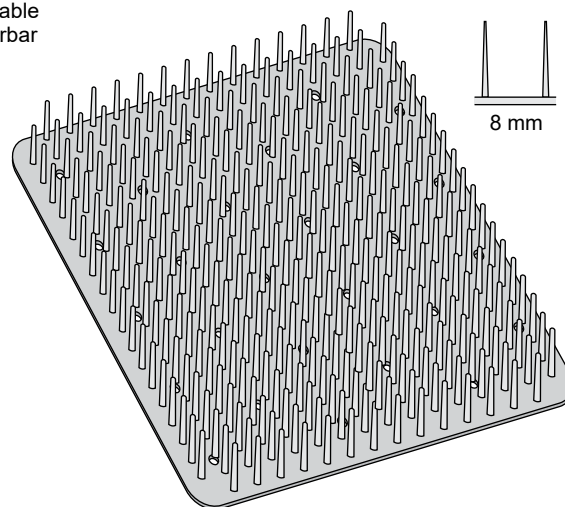

SM 2432 135 x 180 mm

Tappeti in aghi di silicone
Silikon matte
Matte en silicone
Tapis en Silicone
Tapete en agujas de silicona

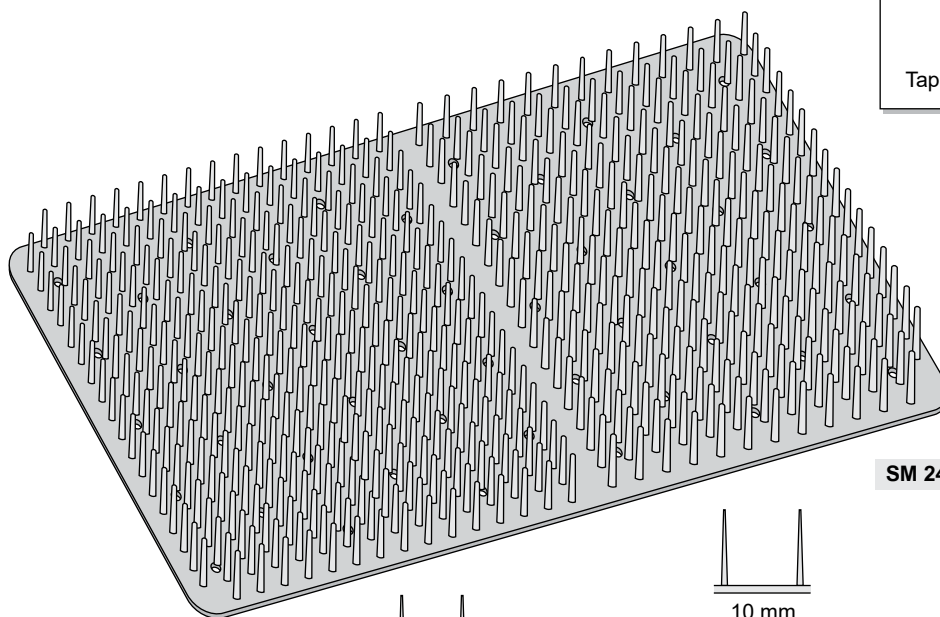

SM 2433 270 x 180 mm

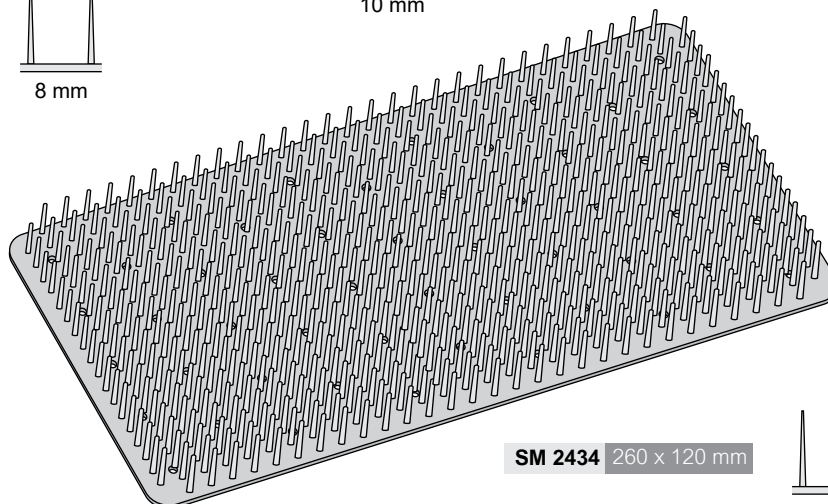
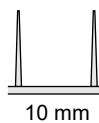
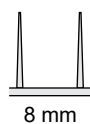

SM 2434 260 x 120 mm



Pinze per prelevare strumenti sterilizzati
Pinzette zum Entnehmen Sterilisierter Instrumente



SF 2435-14 14.5 cm

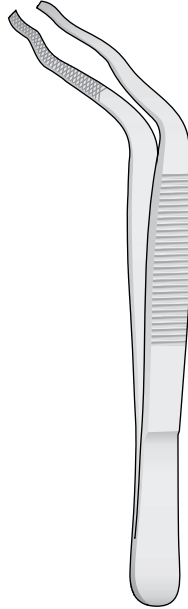

DAVIS
SF 2436-16 16 cm

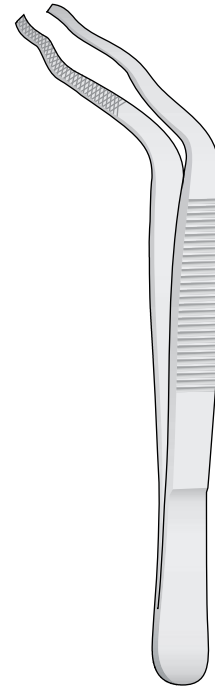

DAVIS
SF 2437-20 20 cm

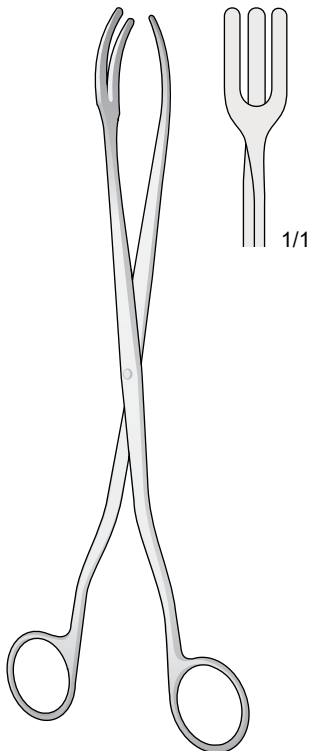

SF 2438-20 20 cm

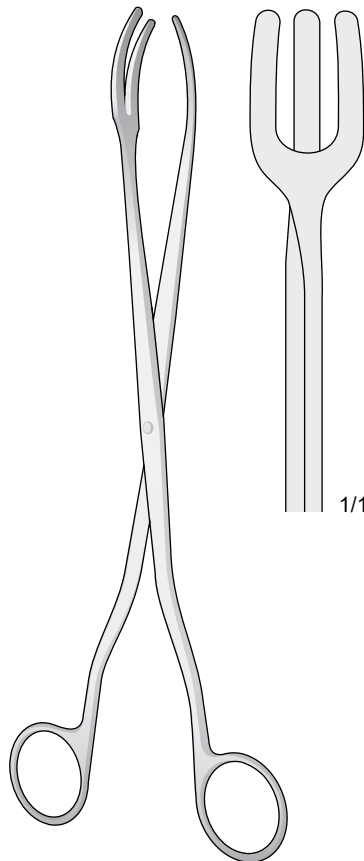

SF 2439-30 30 cm

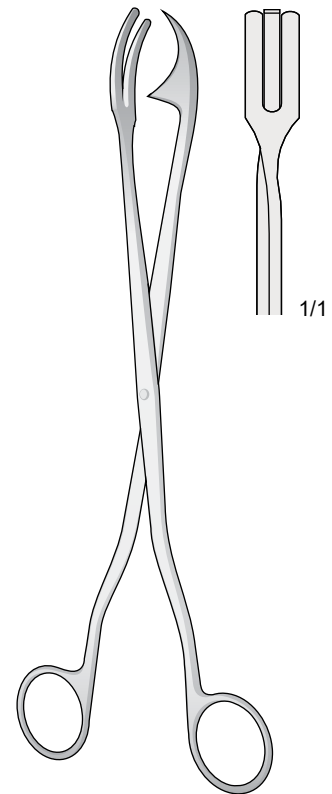

ROGGE
SF 2440-23 23 cm

Pinze per sterilizzazione
 Sterilizing forcep
 Sterilisierzange
 Pinces à stérilisation
 Pinzas para esterilización

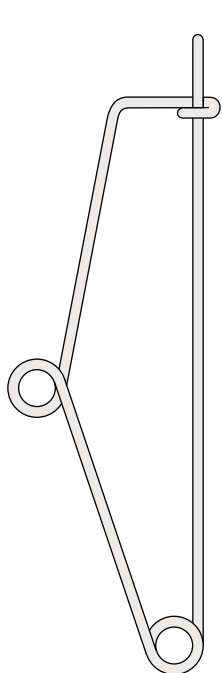

MAYO
SF 2441-14 14 cm

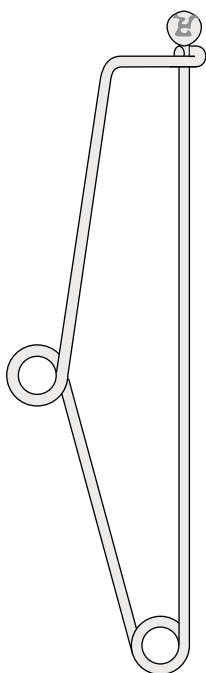

MAYO
SF 2442-14 14 cm

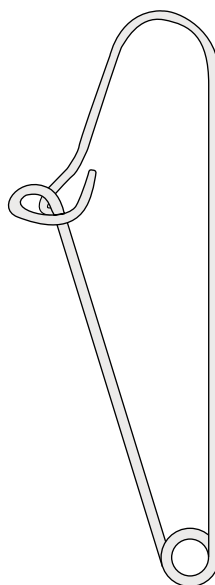

BUNT
SF 2443-11 11 cm

Pinza per materiali da medicazione
 e tamponi usati
 Operating room pick-up forceps
 for used tampons and dressings
 Fassung für verbrauchtes
 Verbandmaterial und Tupfer
 Pince pour pansements
 et tampons souillés
 Pinzas para desechos

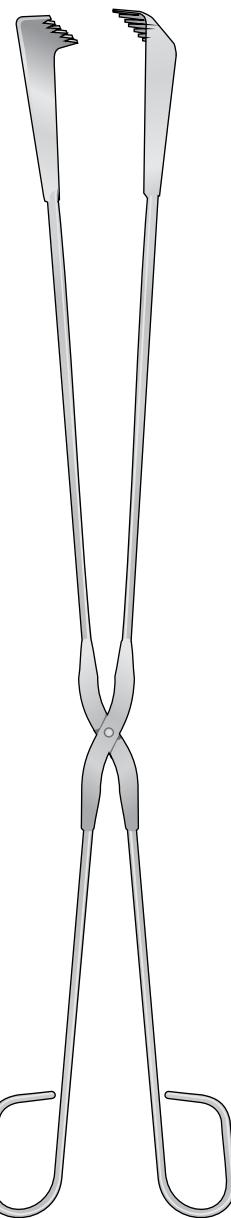

SAUERBRUCH
SF 2446-53 53 cm

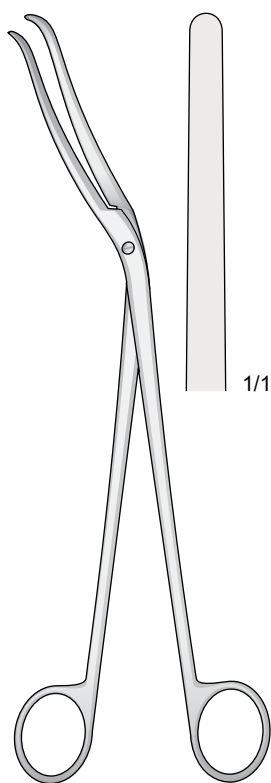

CHEATTLE
SF 2444-26 26.5 cm

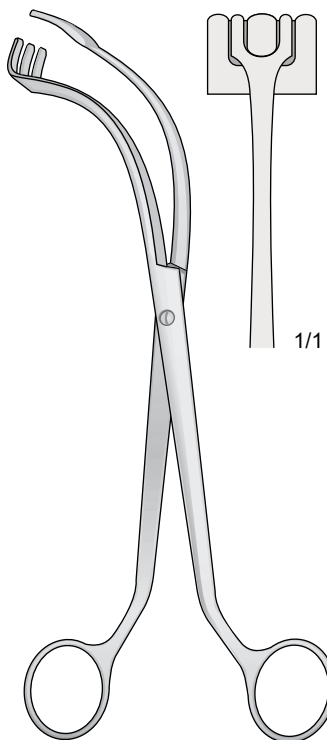

COLLIN
SF 2445-25 25 cm

Manufacturer of high quality
hand-held surgical instruments for
General Surgery | Dental

 Ehsansurgical.com



EHSAN SURGICAL

POSWAL STREET, PASRUR
ROAD
SIALKOT 51310, PAKISTAN

+92 52 3543475
+92 52 3543479

info@ehsansurgical.com

 Ehsansurgical.com